

---

Masters Theses

Student Theses and Dissertations

---

Fall 2008

## Performance of fire-damaged prestressed concrete bridges

Wendy LeAnn Moore

Follow this and additional works at: [https://scholarsmine.mst.edu/masters\\_theses](https://scholarsmine.mst.edu/masters_theses)



Part of the [Civil Engineering Commons](#)

Department:

---

### Recommended Citation

Moore, Wendy LeAnn, "Performance of fire-damaged prestressed concrete bridges" (2008). *Masters Theses*. 6778.

[https://scholarsmine.mst.edu/masters\\_theses/6778](https://scholarsmine.mst.edu/masters_theses/6778)

This thesis is brought to you by Scholars' Mine, a service of the Missouri S&T Library and Learning Resources. This work is protected by U. S. Copyright Law. Unauthorized use including reproduction for redistribution requires the permission of the copyright holder. For more information, please contact [scholarsmine@mst.edu](mailto:scholarsmine@mst.edu).



PERFORMANCE OF FIRE-DAMAGED PRESTRESSED  
CONCRETE BRIDGES

by

WENDY LEANN MOORE

A THESIS

Presented to the Faculty of the Graduate School of the  
MISSOURI UNIVERSITY OF SCIENCE AND TECHNOLOGY

In Partial Fulfillment of the Requirements for the Degree

MASTER OF SCIENCE IN CIVIL ENGINEERING

2008

Approved by

John J. Myers, Advisor  
David Rogers  
Yu-Ning (Louis) Ge

© 2008

Wendy L. Moore

All Rights Reserved

## ABSTRACT

The purpose of this experimental program was to develop and analyze the effects of fire damage on prestressed concrete bridges. Flexural strength and serviceability of the bridge were measured by inputting fire damaged data into a parametric study spreadsheet consisting of a typical 3-span continuous prestressed concrete bridge.

Data was obtained by exposing two types of specimens to different levels of elevated temperatures and then cooling them at room temperature to simulate fire damage. The two specimen types were prestressing strands which were tested in tension and concrete blocks with a single prestressing strand embedded in the center, which were tested in pullout testing. The tension specimens provided information regarding the tensile strength and stiffness of the prestressing strand steel and the pullout testing gave an understanding regarding the bond properties.

Material specific results found that prestressing steel loses significant tensile strength upon exposure to temperatures greater than 500°F (260°C). The bond between the strands and concrete is affected almost immediately with considerable loss occurring at 500°F (260°C). For this bridge design it was found that depending on the location and burning duration of the fire, the structure can survive without losing significant capacity. This applies to both standard time-temperature curve fires and hydrocarbon fuel fires.

## ACKNOWLEDGMENTS

I would like to personally thank Dr. John J. Myers for his advising regarding the research and completion of my master's degree.

In addition to his outstanding service to me as a graduate advisor, I would also like to thank Dr. Myers for his extensive time in assisting me in advising, course work and general guidance throughout my higher educational experience. For the last five years, Dr. Myers has been a valuable individual as a professor and advisor. His direction and experience has helped me make many of the significant decisions I have chosen throughout my time at the university.

I would also like to recognize and thank my committee members Dr. Ge and Dr. Rogers for their time and support.

I would like to give gratitude to Kenny Allison, Ron Haas, Jeff Bradshaw, Travis Hernandez, and Steve Gabel for their outstanding assistance, time and input of ideas during the research process.

Finally, I would like to thank my future husband Daniel Bailey, my parents Scott and Kim Moore and my brothers Craig and Derek Moore for their continuous support and motivation throughout my educational experience.

## TABLE OF CONTENTS

	Page
ABSTRACT .....	iii
ACKNOWLEDGMENTS .....	iv
LIST OF ILLUSTRATIONS .....	x
LIST OF TABLES .....	xiv
NOMENCLATURE .....	xvi
SECTION	
1. INTRODUCTION .....	1
1.1. BACKGROUND .....	1
1.2. OBJECTIVE .....	2
1.3. SCOPE .....	2
1.4. OUTLINE .....	3
2. LITERATURE REVIEW .....	4
2.1. GENERAL .....	4
2.2. PRESTRESSED CONCRETE .....	4
2.2.1. History .....	4
2.2.2. Mechanical Properties .....	5
2.2.3. Manufacturing Process .....	5
2.3. TENSION TESTING .....	6
2.3.1. General .....	6
2.3.2. Prestressing Strands .....	6
2.4. PULLOUT TESTING .....	7
2.4.1. General Bond and Development .....	7
2.4.2. Pullout Test .....	8
2.4.3. Bond Stress .....	8
2.4.3.1 ACI and AASHTO code provisions .....	9
2.4.3.2 FHWA code provisions .....	9
2.4.4. Effects Due to Varying Parameters .....	9
2.4.4.1 High strength concrete .....	9

2.4.4.2 Strand type .....	10
2.5. FIRE DAMAGED MATERIALS FOUND IN BRIDGES .....	10
2.5.1. Concrete.....	10
2.5.1.1 Compressive strength ( $f'_c$ ) for normal strength concrete .....	11
2.5.1.2 Compressive strength ( $f'_c$ ) for high strength concrete .....	15
2.5.1.3 Modulus of elasticity ( $E_c$ ) of concrete .....	15
2.5.1.4 Physical changes .....	17
2.5.2. Mild Steel. ....	17
2.5.3. Prestressing Strands.....	18
2.5.3.1 Tensile strength.....	18
2.5.3.2 Modulus of elasticity.....	21
2.5.4. Steel and Concrete Bond Behavior .....	21
2.6. FIRE MODELS .....	23
2.6.1. Standard Fire Resistance Tests.....	23
2.6.2. Non-Standard Fires.....	24
2.6.2.1 Pool fires .....	24
2.6.2.2 Modeling.....	25
2.7. FIRE DAMAGED STRUCTURES .....	26
3. EXPERIMENTAL PROGRAM.....	28
3.1. TEST MATRIX .....	28
3.1.1. Tension Tests.....	28
3.1.1.1 Phase I.....	31
3.1.1.2 Phase II.....	32
3.1.2. Pullout Tests.....	32
3.2. MATERIALS.....	34
3.2.1. Prestressing Strands.....	34
3.2.2. Concrete.....	35
3.3. DESCRIPTION OF SPECIMENS .....	36
3.3.1. Tension Specimens.....	36
3.3.2. Pullout Specimens.....	36
3.4. TEST SETUP .....	37



3.4.1. Furnace .....	37
3.4.2. Tension Tests.....	39
3.4.3. Pullout Tests.....	42
4. EXPERIMENTAL TEST RESULTS .....	45
4.1. TENSION TESTS.....	45
4.1.1. Visual Observations .....	45
4.1.2. Test Results .....	46
4.1.3. Failure Mode .....	50
4.1.4. Discussion of Results .....	52
4.1.4.1 Tensile strength.....	52
4.1.4.2 Modulus of elasticity.....	56
4.1.4.3 Yield.....	57
4.1.4.4 Tensile strength at elevated temperatures.....	58
4.2. PULLOUT TESTS.....	59
4.2.1. Visual Observations .....	59
4.2.2. Test Results .....	62
4.2.3. Failure Mode .....	66
4.2.4. Discussion of Results .....	72
4.2.4.1 Bond capacity.....	72
4.2.4.2 Implications caused by loss in bond stress .....	75
5. PARAMETRIC STUDY .....	77
5.1. DESIGN EXAMPLE .....	77
5.1.1. Design Properties. ....	79
5.1.2. Load Factors.....	79
5.1.3. Loads .....	80
5.1.4. Reinforcement Details.....	80
5.2. TEMPERATURE PROFILE .....	82
5.2.1. Standard Time-Temperature Curve.....	83
5.2.2. Non-Standard Fire .....	83
5.3. LOCATION OF FIRE .....	84

5.3.1. Fire Below the Bridge at the Critical Positive Moment Section at Midspan .....	84
5.3.2. Fire Above the Bridge at Critical Negative Moment Sections.....	85
5.3.3. Fire Above the Bridge Between Girders .....	85
5.4. MATERIALS.....	85
5.4.1. Prestressing Strands.....	85
5.4.2. Concrete.....	85
5.4.2.1 Compressive strength.....	87
5.4.2.2 Modulus of elasticity and moment of inertia .....	88
5.4.3. Mild Reinforcing Steel.....	89
5.5. HYDROCARBON POOL FIRE CALCULATIONS.....	90
5.6. ASSUMPTIONS.....	91
5.6.1. Fire Effects Entire Length of Girder Equally.....	91
5.6.2. Environmental Effects.....	91
5.7. STUDY RESULTS.....	92
5.7.1. Fire Below the Bridge at the Critical Positive Moment Section at Midspan .....	92
5.7.2. Fire Above the Bridge at Critical Negative Moment Sections.....	98
5.7.3. Fire Above the Bridge Between Girders .....	104
6. FIRE EXPOSED CASE STUDIES.....	109
6.1. GENERAL.....	109
6.2. U.S. ROUTE 7 BRIDGE (RIDGEFIELD, CT).....	109
6.2.1. Accident.....	109
6.2.2. Parametric Study .....	110
6.2.3. Conclusions .....	110
6.3. PUYALLUP RIVER (TACOMA, WA).....	115
6.3.1. Accident.....	115
6.3.2. Parametric Study .....	116
6.3.3. Conclusions .....	116
6.4. I-5 OVERPASS (LYNNWOOD, WA).....	121
6.4.1. Accident.....	121
6.4.2. Parametric Study .....	122

6.4.3. Conclusions .....	122
6.5. CASE STUDY DISCUSSION .....	126
7. CONCLUSIONS AND RECOMMENDATIONS.....	128
7.1. GENERAL.....	128
7.2. FIRE DAMAGED PRESTRESSING STEEL PROPERTIES .....	128
7.3. FIRE DAMAGED BOND PERFORMANCE.....	129
7.4. FIRE DAMAGED BRIDGE PERFORMANCE.....	130
7.5. FUTURE RECOMMENDATIONS .....	130
APPENDIX.....	132
BIBLIOGRAPHY.....	133
VITA .....	139

## LIST OF ILLUSTRATIONS

	Page
Figure 2.1 Variation of steel stress with development length.....	7
Figure 2.2 Residual compressive strength vs. temperature for concrete .....	14
Figure 2.3 Residual strength vs. temperature for mild-reinforcing steel .....	18
Figure 2.4 Residual tensile strength of prestressing strands vs. temperature .....	21
Figure 2.5 ASTM E 119-08 Standard Time-Temperature Curve .....	23
Figure 2.6 Fire along the Bill Williams Bridge in Parker, Arizona due to an overturned diesel tanker .....	27
Figure 2.7 Damaged Norwalk Bridge near Ridgefield, Connecticut due to an overturned gasoline tanker .....	27
Figure 3.1 Schematic and actual view of coupon specimen .....	36
Figure 3.2 Schematic and actual view of pullout specimen.....	37
Figure 3.3 Cylindrical tube furnace .....	38
Figure 3.4 Typical heating setup.....	39
Figure 3.5 MT880 testing machine prior to tension tests .....	40
Figure 3.6 Tension test setup .....	40
Figure 3.7 Pullout test setup cage prior to testing.....	42
Figure 3.8 Pullout test setup with specimen inside steel cage .....	43
Figure 3.9 Base of pullout cage which concrete block was pulled against.....	43
Figure 3.10 Enlarged view of pullout test setup with specimen inside steel cage.....	44
Figure 4.1 Strand exterior after exposure to 500°F (260°C) .....	45
Figure 4.2 Strand exterior after exposure to 800°F (427°C) .....	45
Figure 4.3 Strand exterior after exposure to 1000°F (538°F).....	46
Figure 4.4 Strand exterior after exposure to 1200°F (649°F).....	46
Figure 4.5 Strand exterior after exposure to 1300°F (704°C) .....	46
Figure 4.6 Typical stress-strain curve for tension testing .....	50
Figure 4.7 Typical failure mode of prestressing strand in tension.....	51
Figure 4.8 Residual ultimate tensile strength vs. temperature .....	53
Figure 4.9 Comparison of results with other previous research .....	53
Figure 4.10 Comparison of cooling methods.....	54

Figure 4.11 Comparison of heat soak time .....	55
Figure 4.12 Residual modulus of elasticity vs. temperature .....	56
Figure 4.13 Stress vs. strain for 0.5 in. specimens of Phase I.....	57
Figure 4.14 Stress vs. strain for 0.375 in. specimens of Phase I.....	58
Figure 4.15 Comparison of tensile strength for prestressing strands at elevated temperatures and residual tensile strength of prestressing strands .....	59
Figure 4.16 Initial hairline cracking noted for each compressive strength.....	60
Figure 4.17 Examples of spalling noted after heating process .....	61
Figure 4.18 Classification of heat induced cracking.....	62
Figure 4.19 Pullout load vs. slip for a typical brittle failure .....	67
Figure 4.20 Pullout load vs. slip for a typical ductile failure.....	67
Figure 4.21 Typical failure modes for pullout testing .....	68
Figure 4.22 Comparison of bond stress vs. crack density for each specimen type of 11 ksi, 0.375 in. strands.....	70
Figure 4.23 Comparison of bond stress vs. crack density for each specimen type of 11 ksi, 0.5 in. strands.....	70
Figure 4.24 Comparison of bond stress vs. crack density for each specimen type of 14 ksi, 0.375 in. strands.....	71
Figure 4.25 Comparison of bond stress vs. crack density for each specimen type of 14 ksi, 0.5 in. strands.....	71
Figure 4.26 Average bond stress vs. temperature for 0.5 in. prestressing strands.....	73
Figure 4.27 Average bond stress vs. temperature for 0.375 in. prestressing strands.....	74
Figure 4.28 Percent of original bond stress capacity vs. temperature .....	75
Figure 4.29 Development length and required flexural section capacity for an undamaged and fire damaged girder.....	76
Figure 5.1 Design example bridge cross-section .....	77
Figure 5.2 Design example bridge longitudinal section .....	78
Figure 5.3 Design example composite girder cross-section .....	78
Figure 5.4 Schematic of strand harp location along half of the girder .....	80
Figure 5.5 Strand pattern for parametric study with 0.5 in. diameter, 7-wire, low-relaxation prestressing strand .....	81
Figure 5.6 Strand pattern for parametric study with 0.375 in. diameter, 7-wire, low-relaxation prestressing strand .....	82

Figure 5.7 Verification of ABAQUS calibration to PCI published slab temperatures by Abrams and Gustaferro (1968).....	84
Figure 5.8 Schematic of simplified I-beam used in temperature analysis .....	86
Figure 5.9 Schematic of bottom flange of I-beam with arbitrary concrete material layers indicated.....	87
Figure 5.10 Residual compressive strength of concrete vs. temperature.....	88
Figure 5.11 Temperature profile for half of the 0.5 in. girder cross-section for a 4 hour fire occurring below the bridge at the critical positive moment section at midspan.....	93
Figure 5.12 Positive moment section capacity vs. time exposed to fire .....	94
Figure 5.13 Negative moment section capacity vs. time exposed to fire .....	95
Figure 5.14 Deflection at midspan due to live load vs. time exposed to fire.....	96
Figure 5.15 Deflection at midspan due to self-weight vs. time exposed to fire .....	97
Figure 5.16 Stiffness loss of composite girder vs. time exposed to fire .....	98
Figure 5.17 Temperature profile for composite girder at critical negative moment sections.....	99
Figure 5.18 Positive moment section capacity vs. time exposed to fire .....	101
Figure 5.19 Negative moment section capacity vs. time exposed to fire .....	101
Figure 5.20 Stiffness loss of composite girder vs. time exposed to fire .....	102
Figure 5.21 Deflection at midspan due to live load vs. time exposed to fire.....	103
Figure 5.22 Deflection at midspan due to self-weight vs. time exposed to fire .....	103
Figure 5.23 Temperature profile along 12 in. (30.5 cm) width of deck after 4 hours of fire exposure .....	105
Figure 5.24 Deflection due to self-weight vs. time exposed to fire.....	106
Figure 5.25 Deflection due to live load vs. time exposed to fire.....	106
Figure 5.26 Stiffness loss of composite girder vs. time exposed to fire .....	107
Figure 6.1 Aftermath of the bridge fire along U.S. Route 7 Bridge near Ridgefield, Connecticut .....	110
Figure 6.2 Temperature profile for fire on bridge deck.....	111
Figure 6.3 Positive moment section capacity before and after the fire.....	112
Figure 6.4 Negative moment section capacity before and after the fire .....	113
Figure 6.5 Deflection at midspan before and after the fire .....	114
Figure 6.6 Stiffness of composite section before and after the fire .....	114
Figure 6.7 Fire located below bridge near Tacoma, Washington .....	115

Figure 6.8 Damaged concrete located at the bottom of the girders .....	116
Figure 6.9 Temperature profile of bottom of girder after fire exposure of 2 hours .....	117
Figure 6.10 Positive moment section capacity before and after the fire.....	118
Figure 6.11 Negative moment section capacity before and after the fire .....	119
Figure 6.12 Deflection at midspan due to self-weight and live load before and after the fire.....	120
Figure 6.13 Stiffness of composite section before and after the fire .....	120
Figure 6.14 Bridge fire caused by a tractor trailer carrying gasoline which occurred on U.S. Interstate-5 near Lynnwood, Washington.....	121
Figure 6.15 Temperature profile for fire on bridge deck.....	123
Figure 6.16 Positive moment section capacity before and after fire.....	124
Figure 6.17 Negative moment section capacity before and after the fire .....	124
Figure 6.18 Deflection at midspan due to self-weight and live load before and after the fire.....	125
Figure 6.19 Stiffness of composite section before and after the fire .....	126

## LIST OF TABLES

	Page
Table 3.1 Tension test matrix Phase I: 0.375 in. strand diameter .....	29
Table 3.2 Tension test matrix Phase I: 0.5 in. strand diameter .....	30
Table 3.3 Tension test matrix Phase II: 0.375 in. strand diameter.....	31
Table 3.4 Tension test matrix Phase II: 0.5 in. strand diameter.....	31
Table 3.5 Pullout test matrix for 11 ksi concrete specimens .....	33
Table 3.6 Pullout test matrix for 14 ksi concrete specimens .....	34
Table 3.7 Mechanical properties of prestressing strands .....	35
Table 3.8 Mix design and strength properties of concrete pullout specimens.....	35
Table 3.9 Testing properties of prestressing strands.....	41
Table 4.1 Test results Phase I: 0.375 in. strand diameter .....	47
Table 4.2 Test results Phase I: 0.5 in. strand diameter .....	48
Table 4.3 Test results Phase II: 0.375 in. strand diameter .....	49
Table 4.4 Test results Phase II: 0.5 in. strand diameter .....	49
Table 4.5 Test results 11 ksi: 0.5 in. strand diameter .....	63
Table 4.6 Test results 11 ksi: 0.375 in. strand diameter .....	64
Table 4.7 Test results 14 ksi: 0.5 in. strand diameter .....	65
Table 4.8 Test results 14 ksi: 0.375 in. strand diameter .....	66
Table 4.9 Average bond stress specification limits .....	73
Table 5.1 Assumed undamaged material properties .....	79
Table 5.2 Fire damaged girder compressive strength and non-composite moment of inertia values.....	94
Table 5.3 Fire damaged deck compressive strength and composite moment of inertia values.....	100
Table 5.4 Damaged deck compressive strength and deck moment of inertia values ....	104
Table 6.1 Fire damaged deck compressive strength and composite moment of inertia values before and after the fire.....	111



Table 6.2 Fire damaged girder compressive strength and non-composite moment of inertia values before and after the fire.....	116
Table 6.3 Fire damaged deck compressive strength and composite moment of inertia values before and after the fire.....	123

## NOMENCLATURE

Symbol	Description
$A_{ps}$	Area of prestressing strand
$d$	Diameter of reinforcing bar or strand
$D_{max}$	Maximum diameter of an unconfined hydrocarbon pool spill
$E_c$	Modulus of elasticity of concrete
$E_{cu}$	Percent of residual modulus of elasticity for concrete
$E_{ps}$	Modulus of elasticity of prestressing steel
$E_s$	Modulus of elasticity of mild reinforcing steel
$f_c$	Compressive strength of concrete
$f_{ps}$	Stress in prestressing steel at nominal flexural strength
$f_{pt}$	Stress in prestressing strand prior to transfer of prestress
$f_{pu}$	Tensile strength of prestressing steel
$f_{py}$	Yield strength of prestressing steel
$f_{se}$	Effective stress in prestressing steel
$f_u$	Ratio of the ultimate prestressing steel tensile strength at a given temperature to the ultimate prestressing steel tensile strength
$f_y$	Yield strength of mild reinforcing steel
$g$	Acceleration of gravity
$I_c$	Moment of inertia of concrete
$L$	Embedment length of strand in pullout test specimen
$l_d$	Development length of prestressing strand
$l_f$	Flexural length of prestressing strand
$l_t$	Transfer length of prestressing strand
$M_u$	Factored moment at section
$P$	Maximum load applied during a pullout test
$p_{ps}$	Perimeter of prestressing strand
$T$	Temperature
$u$	Bond stress

$V_L$	Volume of an hydrocarbon pool spill
$W_c$	Unit weight of concrete
$y$	Liquid burning rate
$y_t$	Distance from the centroidal axis of gross section to tension face
$\rho$	Liquid fuel density
$\nu$	Regression rate
$\dot{m}''$	Mass burning rate of fuel per unit area

# 1. INTRODUCTION

## 1.1. BACKGROUND

Bridges alone are the most effective way to move commerce across bodies of water or low-lying elevations. They provide means for trade and communication to travel across land quickly and efficiently. However, as with any structure there lies the risk of damage or destruction, which can be attributed to a number of sources. Natural disasters, such as a hurricane or tornado, accidents, such as spilled gasoline tankers, or terrorism are all possible and common causes for damage to a bridge's structural integrity. Often the damage due to extreme events to the bridge is quite severe keeping the bridge out of commission for a large extent of time.

In particular, fire damage is a common and severe cause of destruction caused by many different disasters. It is difficult to recover quickly from these incidents because very little is known regarding the extent of damage caused by a fire to a bridge. Accidents such as the Bill Williams River Bridge in Arizona as well as a number of exploding tankers in Iraq have brought to light the frequency of fire on bridges and the crippling results the damage has on society afterwards. The result is often a complete repair of the bridge which proves to be costly and creates problems with traffic flow. In some cases a trade route is completely closed requiring travelers to travel 100 miles (161 km) or more out of their way to reach their destination.

There are a number of studies which have been performed on prestressed concrete (PC) bridges following fire damage. However, this research is either limited to the exterior of the bridge or is performed by decommissioning the bridge and testing components of it in the lab. Internal observations and flexural strength testing cannot be performed on existing bridges. However, with an increase in the understanding of how fire and extreme temperature affect the bridge an educated decision on the structural integrity of the bridge will be able to be made without laboratory testing. This will result in fewer repairs and minimize the economic and commercial implications typically caused by fire damage.

## 1.2. OBJECTIVE

The objectives of this study include:

1. To develop an understanding of bridge behavior after exposure to fire. Fire damage to bridges is a common occurrence, yet investigation of the fire is still very difficult and time consuming. With this research a clearer understanding regarding the serviceability and capacity of the structure will be obtained.
2. Determine properties for grade 270 seven-wire prestressing strands before and after exposure to elevated temperatures. This information will help to understand the extent of damage when strands are exposed to high temperatures.
3. Determine bond stress between concrete and grade 270 seven-wire prestressing strands after exposure to elevated temperatures.

## 1.3. SCOPE

Within this research an analysis was performed to understand how a typical prestressed concrete bridge would be affected by fire. Using a Prestressed-Precast Concrete Institute (PCI) design example and data obtained from laboratory testing and finite-element modeling (FEM), a parametric study was developed to analyze the loss of capacity to the structure after exposure to elevated temperatures.

Laboratory testing included two types of prestressing strand testing, tension and pullout. Tests were performed on strands which had been exposed to elevated temperatures and allowed to cool. The data obtained from the tension testing gave an understanding of the tensile strength and stiffness properties of the prestressing strands subjected to elevated temperatures. From the pullout testing, information was determined regarding the bond stress capacity of the prestressing strands and concrete.

Case studies were performed by applying data from actual events to the parametric study. An analysis was then performed to determine the capacity and structural integrity of the actual damaged bridge.

#### 1.4. OUTLINE

This thesis is broken into seven parts. The first section, Introduction, contains background information, scope, objectives and outline. It introduces the information and explains what is included in the publication.

The second section is the Literature Review, which outlines all of the previous research performed on this particular topic.

Section three, Experimental Program, contains the test matrix, materials, specimens and test setup for the testing performed in this study.

The fourth section, Experimental Test Results, provides the results for the testing explained in section three.

Section five, Parametric Study, gives a detailed explanation of the parametric study performed including the design example chosen, material properties and assumptions. The results from this study are also provided for three different fire locations.

In section six, Case Studies, three bridge fire incidents are analyzed using the parametric study procedure given in section five.

Conclusions and Recommendations, section seven, is the final section in the thesis. This section gives final concluding remarks and recommendations regarding the information presented in the preceding six sections.

## 2. LITERATURE REVIEW

### 2.1. GENERAL

The materials of which prestressed concrete is made up has been widely studied over the last several hundred years. Due to the extensive research a strong understanding exists regarding the behavior and properties of these materials. However, there still exists important areas where research is needed. In particular, little is known regarding the behavior of materials exposed to elevated temperatures such as a fire.

### 2.2. PRESTRESSED CONCRETE

The use of cold-draw prestressing steel as reinforcement in concrete is common among bridge design throughout the world. This composite material is particularly useful for designs consisting of large spans where the dead load will cause significant cracking and deflection. Unlike mild steel reinforcement, prestressing steel is stressed and cause a compression force within the concrete. This prevents cracking and increases the structure's capacity. A prestressed concrete member will also have a longer life expectancy due to the prevention of cracks. Without cracks the steel will not be exposed to the environment and therefore will be at a reduced risk of corrosion. The increased capacity, ability to sustain longer spans, and durability make this type of material an advantageous choice of construction.

**2.2.1. History.** Prestressed concrete has been a developing technology since the late 1800s when P. H. Jackson invented a method that incorporated a tie rod to connect individual blocks (Nawy, 2006). Since this time the concept has evolved slowly with that of other construction practices.

In the 1900s two systems, the Freyssinet and Magnel, named by their inventors were developed which allowed bridges to be built faster than previous methods. These methods were incorporated into construction in Europe where consistent bridge damage was occurring due to World War II (Nawy, 2006.) Significant contributions were made by T.Y. Lin in the mid-1900s, with the most important being the simplification of the design process (Yang, 2003).

Today prestressed concrete is quite common and can be seen in bridges, office buildings, parking garages, stadiums and other structures. Research is ongoing, but extensive understanding of the mechanisms and behavior is already in place.

**2.2.2. Mechanical Properties.** Prestressing steel used in bridge applications consist of seven individual prestressing wires wrapped together to form one strand or tendon as described by ASTM A 416/A 416M-06. The terminology strand and tendon are used interchangeably to denote the individual steel wires wrapped together. Two grades of 7-wire strands are produced, grade 250 (1725) and grade 270 (1860) which have ultimate tensile strengths of 250 ksi (1725 MPa) and 270 ksi (1860 MPa) respectively. In addition to the seven-wire strand, two-wire and three-wire strands exist, but are uncommon in bridge design practice.

For each grade of strand there are also different types and sizes. The two types are low-relaxation and normal-relaxation. However, due to the progression of research and design the low-relaxation is used predominantly in construction and is the standard type mentioned in ASTM A416/A 416M-06. Sizes come in sixteenths of an inch and range from 0.25 in. (6.35 mm) to 0.6 in (15.24 mm) for grade 250 and 0.375 in. (9.53 mm) to 0.6 in. (15.24 mm) for grade 270 (ACI 318-05).

The ACI 318-05 Building Code specifies the modulus of elasticity to be either reported by the manufacturer or determined by tests. This value typically varies between 27,000 ksi (186 GPa) and 29,000 ksi (200 GPa) (Collins and Mitchell, 1997). AASHTO LRFD Bridge Design Specifications (1998) give the design value to be 28,500 ksi (197 GPa) for strands.

**2.2.3. Manufacturing Process.** Initially, prestressing wire starts out as hot-rolled rods. The rods are put through a process called “patenting” where they are passed through a furnace with different heat stages. From there the rods are cooled and the cold-working process begins. This involves pulling or drawing the rods through a series of dies. The cold-working process improves the mechanical properties of the steel while also shrinking the cross-sectional area into wire. The wires are then pulled through a



performing head where they are wrapped together to form the strand used in construction. The last step in the process consists of heating the strands to 650 °F (343 °C) to remove the residual stresses. This step is called “stress relieving”. (Anderson, 1964)

The wire used for prestressing strands contains approximately 0.70 to 0.85 percent carbon. For hypoeutectoid steels, which are steels that contain less than an approximate carbon content of 0.80 percent, the critical eutoid point is 1340 °F (727 °C). This is the critical temperature at which significant metallurgical transformations occur, such as deeper hardening, loss in toughness, and higher internal stresses. Within the temperatures leading up to the eutoid point the start of these changes in structure begin to take place. Initial changes include loss of strength, ductility and metallurgical structure (United States Steel, 1971).

## 2.3. TENSION TESTING

**2.3.1. General.** Tension tests for steel are all governed by ASTM E8-04 “Standard Test Methods for Tension Testing of Metallic Materials.” This document provides specific detail as to how the test shall be performed and the results analyzed. ASTM A370-07a also provides information for all types of steel testing (tension, bend, hardness and impact) and gives specific guidelines based on different types of bar products (fasteners, round wire, multi-wire, etc.).

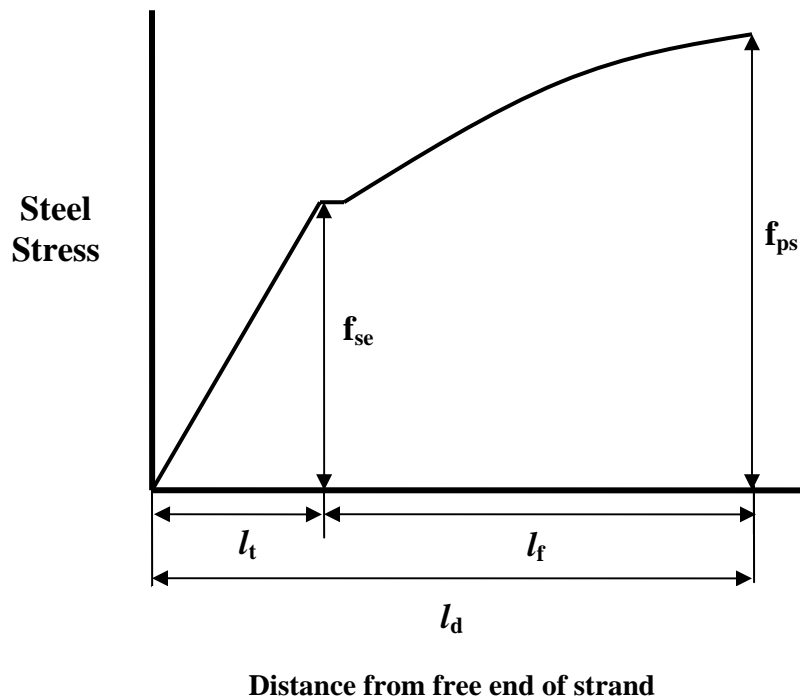
**2.3.2. Prestressing Strands.** In addition to the general specifications for tension testing of steel, ASTM A 416/A 416M-06 and ASTM A370-07a Annex A7 have also been published as governing standards for the tension testing of seven-wire prestressing strands.

Within ASTM A370-07a Annex A7 a recommended procedure and apparatus are given. Due to the geometry of the strand, a specific method is not required and it is acceptable to employ a method of choice as long as the strand meets the minimum breaking strength given by ASTM A 416/A 416M-06. Guidelines for determining the yield strength and elongation are also given by both specifications.

## 2.4. PULLOUT TESTING

**2.4.1. General Bond and Development.** Bond testing can be performed in a number of ways. Typical specimens include pullout, beam-end, beam anchorage and splice (ACI 408R-03).

Bond consists of two different components, transfer length ( $l_t$ ) and flexural length ( $l_f$ ). The transfer length is the distance needed to develop the effective prestressing stress,  $f_{se}$ . The flexural length is the length needed after the transfer to maintain the concrete-steel bond. The sum of the transfer length and flexural length equals the total development length ( $l_d$ ). A typical plot of the development length of a prestressing strand is given in Figure 2.1.



**Figure 2.1** Variation of steel stress with development length (PCI Design Handbook, 2004)

**2.4.2. Pullout Test.** Pullout testing is one of the simplest methods used to evaluate bond strength behavior. A strand of interest is cast inside a concrete specimen. After curing, the concrete is positioned against a plate and the strand is pulled from the concrete. For this test, the area of the concrete bearing on the plate is placed in compression and the strand is in tension. In actuality, a concrete structure would be in tension and only the bearing surface of the strand would be in compression. Due to this occurrence, the test is only used to determine maximum bond stress and is, therefore, not recommended by ACI Committee 408 as a means of characterizing or calculating the development length.

With pullout testing, splitting is likely to occur if the compressive force is located at the steel-concrete surface. This can be prevented by moving the compressive force away from the steel-concrete surface, adding transverse reinforcement or increasing mass of concrete (Ferguson et al. 1954).

**2.4.3. Bond Stress.** Within the various codes requirements there are equations that specify development length. These equations for development length consist of two parts, flexural and transfer. Although the pullout test is not recommended for determining overall development length, it can be used to correlate the flexural and transfer lengths to bond stress.

Russell and Burns (1996) noted that the ACI and AASHTO code requirements were based on assumed bond stress values. Therefore, the equation for the bond stress could be developed by solving equilibrium on the strand. For a given code requirement for the development length Equation 2.1 can be used to determine the bond stress where  $f_{se}$  is the effective stress in the prestressing steel,  $f_{ps}$  is the stress in the prestressing steel at nominal flexure,  $d$  is the diameter of the bar,  $l_f$  is the flexural development length given by the code  $A_{ps}$  is the area of the strand and  $p_{ps}$  is the perimeter of the perimeter of the strand.

$$u = \frac{(f_{ps} - f_{se})A_{ps}}{l_f p_{ps}} \quad \text{Equation 2.1}$$

Russell (1996) found that the transfer bond stress was higher than the flexural bond stress due to flexural cracking which occurs during loading and disrupts bonding, reducing overall bond strength.

**2.4.3.1 ACI and AASHTO code provisions.** The American Concrete Institute (ACI 318-05, 2005) and Association of State Highway and Transportation Officials (AASHTO, 1998) code give Equation 2.2 as the required development length for a prestressing strand.

$$l_d = l_t + l_f = \frac{f_{se}}{3}d + (f_{ps} - f_{se})d \quad \text{Equation 2.2}$$

**2.4.3.2 FHWA code provisions.** The Federal Highway Administration (FHWA-RD-98-116, 1998) code provisions differ slightly from the ACI and AASHTO codes in that their equation for development length is a function of the steel as well as the compressive strength of the concrete. The equation is given as Equation 2.3. The equation is based on research of compressive strengths up to 10 ksi (68.9 MPa). FHWA requires that due to the limited research 10 ksi (68.9 MPa) should be used in the equation for all concrete compressive strengths greater than 10 ksi (68.9 MPa). This provides a conservative value based on existing research.

$$l_d = l_t + l_f = \left( \frac{4f_{pt}d}{f'_c} - 5 \right) + \left( \frac{6.4(f_{ps} - f_{se})d}{f'_c} + 15 \right) \quad \text{Equation 2.3}$$

**2.4.4. Effects Due to Varying Parameters.** The bond between concrete and prestressing strands is based on a number of various parameters. Several of these mechanisms have been researched and examined to understand how they affect the development length of prestressing strands.

**2.4.4.1 High strength concrete.** The bond between prestressing strands and high strength concrete is of particular interest due to its wide use in prestressed concrete.

Chao (2005) performed pullout testing on prestressed blocks with 11 ksi (75.8 MPa) concrete and an embedment length of 4 in. (101.6 mm). Under monotonic loading it was reported that the 0.5 in. (12.7 mm) diameter strand produced an ultimate bond strength of 3800 lbs (16.9 kN). This was equivalent to an average bond stress of 440 psi (3.0 MPa).

A study performed by Steinberg and Lubbers (2003) examined bond behavior of prestressing strands and ultra-high performance concrete. Three average compressive strengths of 21 ksi (144 MPa), 20 ksi (137 MPa) and 19 ksi (131 MPa) were tested. The method of bond testing employed was pullout testing of concrete blocks. It was found that the bond increased significantly for ultrahigh-performance concrete specimens in comparison to conventional concrete of 4 ksi (27.6 MPa).

**2.4.4.2 Strand type.** Research has concluded that strand properties do play a role in the bond of the concrete and strand. Lane (1992) noted that the transfer length of epoxy-coated specimens was shorter than that of strands without epoxy.

It has been found that as the strand diameter increases the bond length also increases. Bond stress is inversely related to bond length and decreases as the strand diameter increases (Hanson and Karr, 1959; Lane, 1992; Martin and Scott, 1976).

## **2.5. FIRE DAMAGED MATERIALS FOUND IN BRIDGES**

Materials which are commonly affected by bridge fires include the concrete, prestressing strands and mild steel reinforcement. The amount of information regarding the fire damage properties varies by material. Within this research residual properties of any material are defined as the property of the material after it has been heated and then cooled back to room temperature.

**2.5.1. Concrete.** Concrete damage caused by fire has been widely researched. A significant amount of data has been published which allows engineers to understand the compressive strength properties of concrete during and after fire exposure. The first known study of fire-damaged reinforced concrete was conducted in 1877 by Hyatt.

Hyatt was looking for a material that would be fire-resistant material and proposed the use of steel in conjunction with concrete. Through a series of tests, it was found that indeed the two materials worked well together and provided protection against fire.

**2.5.1.1 Compressive strength ( $f'_c$ ) for normal strength concrete.** Significant research regarding actual concrete performance after exposure to elevated temperatures was first published by Malhotra (1956) who researched the effects of weight/cement ratio, curing conditions, loading, cooling and aggregate/cement ratio. The experimental program consisted of three small concrete cylinders for each variable at each temperature. Temperatures in his study ranged from 392°F-1112°F (200°C-600°C). Based on early testing, Malhotra found spalling to occur when a large variance in temperature existed between the exterior and center of specimen. As a solution the rate of heating was controlled and a maximum gradient of 212°F (100°C) was allowed to exist.

Conclusions obtained from Malhotra's work were that the water/cement ratio did not affect the compressive strength of the concrete, however the aggregate/cement ratio did. In addition, stressed specimens tested at elevated temperatures maintained a higher percent of residual stress than that of those who were tested at elevated temperatures and not stressed. Cooling caused the specimens to lose additional compressive strength.

Additional research by Zoldners (1960) compared different aggregate mixes exposed to elevated temperatures, slowly cooled and then tested in compression and flexure. Aggregates such as sandstone, gravel aggregate and expanded slag experienced an increase of compressive strength at lower temperatures, but later lost compressive strength as temperature increased. Limestone did not see this initial increase in compression, but did maintain the highest flexural strength of the aggregates.

Various aggregates were the primary interest for a study performed by Abrams (1968). For the experiment three types were examined; carbonate, siliceous and an expanded shale lightweight aggregate. A constant loss in compressive strength with temperature was found for all aggregates. The three types also followed the same trend up until 1000 °F (538 °C) at which the siliceous based concrete experienced a more significant loss in compressive strength for the remainder of the temperatures.

Also included with Abrams' study were the compressive strength properties of stressed and unstressed specimens at elevated temperatures. It was found that stressed

specimens at elevated temperatures produced higher compressive strengths than those of the same unstressed specimen as first noted by Malhotra. Also, unstressed residual compressive strengths were lower than compressive strength properties measured at elevated temperatures. These compressive strength properties for all tests were found true for all aggregates.

Another group of researchers, Harada et al. (1972), presented data based on types of aggregates. Their findings for residual compressive strength were lower than that of Zoldners', but were based on different types of aggregate. The test program included aggregates from the Midori River (sedimentary rock), Tama River (sedimentary rock), Shirakwa (product of pyroxene-andesite, amphibolite, andesite), Shimazaki (pyroxene-andesite), Mt. Asama (siliceous rock), Yatsushiro (limestone), all located in Japan and the surrounding region. The data obtained from the test program produced average residual compressive strength values of 80 percent for 212°F (100°C), 75 percent for 572°F (300°C), and 60 percent for 842°F (450°C).

Weigler and Fischer (1972) studied the effects of different aggregate, different cements and different cooling methods. The results based on aggregate were similar to those obtained by Zoldners. For cement, Weigler and Fischer compared Portland Cement with blast-furnace cement. It was found that for unstressed concrete of different cement and aggregates the compressive residual strengths are similar.

In terms of cooling, Weigler and Fischer found that additional compressive strength loss occurred to the specimens which were cooled overtime at room temperature. Whereas specimens who were stored under water were able to recover some compressive strength as time progressed. Weigler and Fischer proposed an explanation to the phenomenon based on two main things. The first being the different thermal expansion coefficients within the mix which cause the concrete structure to be loosened. The second was the decomposition of the hydrated cement which continues to occur during cooling. Weigler and Fischer noted that specimens cooled in water were able to recover some compressive strength due to rehydration of the material.

More research based primarily on aggregate type was presented by Mohamedbhai (1983). His variables included fine aggregate from the rock formations of the island of Mauritius. Three types of sand were used; coral, basalt and a mixture of coral and basalt

of equal quantities. Ordinary Portland cement was used with the mix as well. After performing the experiment Mohamedbhai found the residual compressive strengths of these concretes to initially increase at a temperature of 212°F (100°C) and then gradually decrease thereafter. Overall the residual compressive strengths found for each aggregate were similar to that of the other researchers. Specifically the residual compressive strength of the coral sand mix was less than that of the basaltic mix.

In addition to residual strength properties, Mohamedbhai also confirmed found that the type of cooling (air-cooled or water-cooled) does not have an effect on the residual compressive strength of concrete heated up to temperatures of 752°F (400°C) as Wiegler and Fischer had earlier proposed. After 752°F (400°C), the water-cooled specimens had higher compressive strengths as compared to those cooled in air. Overtime (one to seven days) water-cooled specimens were able to recover some residual compressive strength, whereas air-cooled specimens continued to lose compressive strength. These results confirmed the work of Weigler and Fischer from previous years.

Hertz (1986) examined residual properties of concrete as well as the heating rate. A rate of 50°F (10°C) per minute and 34°F (1°C) per minute were compared. It was found that at lower temperatures the faster heating rate developed conservative residual compressive strengths versus that of the slower heating rate. However, at temperatures greater than 932°F (500°C), it was found that the faster heating rate to be slightly higher. Overall the values determined from both heating rates were consistent with that found by previous researchers.

Residual concrete compressive strengths of blended cements were analyzed by Papayianni and Vallasis (1991). Three pozzolanic materials: Santorin Earth, lignite fly ash from the area of Ptolemaida (Greece) and lignite fly ash from Megalopoli (Greece) were used to partially replace Portland cement. It was determined that concrete of blended cement mixes lose more compressive strength than the concrete of Portland cement reported by Abrams and Malhotra. This was said to be due to the large quantities of pozzolan pastes which decompose at 392°F (200°C).

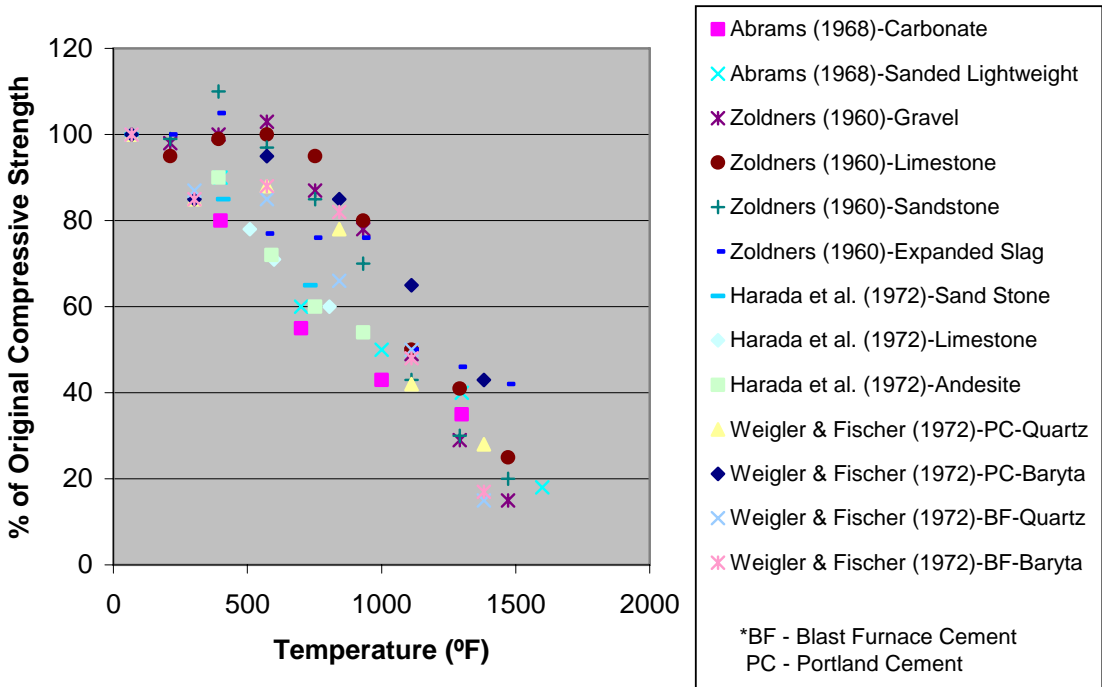
Additional research was performed by a group of individuals whose report confirmed that compressive strength values for fire-damaged concrete are significantly higher for stressed specimens compared to unstressed specimens which is in agreement



with Malhotra and Abrams (Chakrabarti et al., 1994). All specimens were found to regain approximately 80 percent of their undamaged compressive strength upon an elapsed period of cooling. This was said to be caused by the rehydration of concrete as described previously by Weigler and Fischer and Mohamedbhai.

Using data previously published, Kumar et al. (2003) developed a test program which analyzed the deflection and flexural strength of fire damaged beams. It was determined that reinforced concrete beams exposed to fire for 1 hour maintain 83 percent capacity and those exposed to fire for 2 hours maintain 50 percent.

The percent of original compressive strength of concrete versus temperature for the data presented can be seen in Figure 2.2. Various types of aggregate and cooling methods are given in the graphical representation.



Conversion Factor: 1°F = 0.56°C

Figure 2.2 Residual compressive strength vs. temperature for concrete

**2.5.1.2 Compressive strength ( $f'_c$ ) for high strength concrete.** Research has also been performed to understand how fire-damaged concrete properties of high strength concrete (HSC) compare with that of normal strength.

Noumowe et al. (1995) tested cylinders from two compressive strengths, 5.5 ksi (38.1 MPa) and 8.9 ksi (61.1 MPa). The specimens were then heated to temperatures of 302°F (150°C), 527°F (300°C), 842°F (450°C) and 932°F (500°C), cooled and then tested in compression and tension. It was found that in compression the two mixes performed similarly in strength loss, but that the 8.9 ksi (61.1 MPa) mix has slightly less residual direct tensile strength.

Chan et al. (1996) performed research where he tested concrete cubes of 4.1 ksi, 6.8 ksi, 11.0 ksi, 11.5 ksi and 13.6 ksi (76 MPa, 79 MPa, 94 MPa, 28 MPa and 47 MPa) in compression after exposing them to temperatures 752°F-2192°F (400°C-1200°C). Chan reported that the all mixes performed in a similar manner, but that at lower temperatures the higher strength mixes maintained slightly higher residual compressive strength values.

In similar testing, Luo et al. (2000) reported the high strength concrete to degenerate more severely. High strength was defined as concrete with compressive strengths in the range of 14.1 ksi (97.3 MPa) to 16.5 ksi (113.5 MPa). Based on mercury intrusion porosimetry, the porosity of both high strength and normal strength specimens was measured after heating. Luo determined that the difference between the microstructure of the two types of concrete became more significant after heating, due to the increase in cumulative pore volume by the high strength concrete mix. Noumowe and Chan's findings were also confirmed in that both normal and high strength concretes perform similarly in compression after heating.

**2.5.1.3 Modulus of elasticity ( $E_c$ ) of concrete.** Often overlooked in fire-damaged concrete research is the residual modulus of elasticity. Minimal research has been reported regarding this loss in stiffness as the temperature increases.

Papayianni and Valiasis (1991) performed testing on concrete to determine the residual modulus of elasticity in accordance to ASTM C496-71. The concrete examined contained pozzolanic materials as a partial replacement for Portland Cement. These materials included Santorin Earth, Ptolemaida and lignite fly ash as previously described

in Section 2.5.1.1. Specimens were exposed to temperatures of 392°F (200°C), 752°F (400°C), 1112°F (600°C) and 1472°F (800°C) and then cooled. Residual moduli of elasticity values were then found to be 70 percent, 25 percent, 10 percent and 5 percent respectively.

Nassif et al. (1994) analyzed the stress-strain curve for specimens heat treated below 878°F (470°C), but used a broader range of temperatures which allow the behavior of the concrete to be captured more accurately. The temperatures studied were 423°F (217°C), 464°F (240°C), 549°F (287°C), 608°F (320°C), 712°F (378°C), and 878°F (470°C) and then cooled back to 68°F (20°C). Specimens for this program were put through four load-unload cycles with a maximum stress of 625.7 psi (4.5 MPa). Based on the results a well-defined curve was plotted for the residual modulus of elasticity for temperatures up to 878°F (470°C), which was similar to that of Papayianni and Valiasis.

Research performed by a group of researchers examined residual modulus of elasticity for both normal and high strength concrete mixes (Chang et al., 2006). Their experimental matrix consisted of two compressive strength types, 5.8 ksi (40 MPa) and 3.9 ksi (27 MPa) in which eight (8) and four (4) specimens were tested per temperature respectively. The specimens were heated to a total of eight temperatures, 212°F (100°C), 392°F (200°C), 572°F (300°C), 752°F (400°C), 932°F (500°C), 1112°F (600°C), 1292°F (700°C) and 1472°F (800°C), as well as room temperature. Using the data obtained Equations 2.4 and 2.5 were developed which give the percent of residual modulus of elasticity for concrete  $E_{cu}$ , based on temperature  $T$  (in Celsius). The equation produced is similar to results obtained by Nassif and Papayianni and Valiasis.

$$E_{cu}(T) = -0.00165T + 1.003 \quad 68^{\circ}F < T \leq 257^{\circ}F \quad \text{Equation 2.4}$$

$$E_{cu}(T) = \frac{1}{1.2 + 18(0.0015T)^{4.5}} \quad 257^{\circ}F < T \leq 1472^{\circ}F \quad \text{Equation 2.5}$$

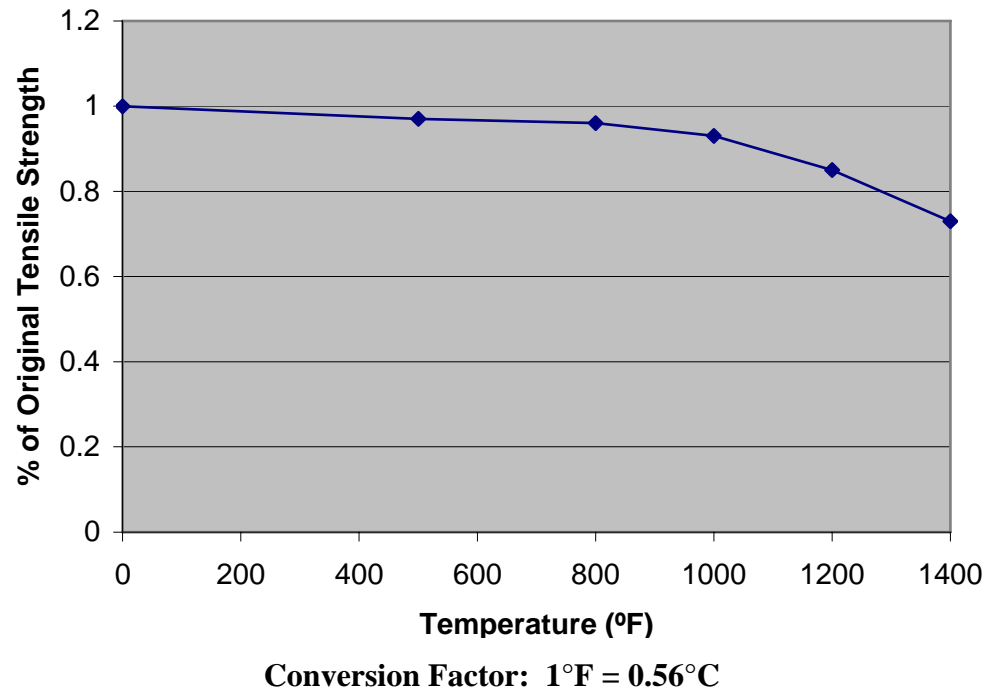
**2.5.1.4 Physical changes.** Color changes, cracking and spalling are all physical effects caused by elevated temperature exposure to concrete. The extent to which these effects occur varies based on the temperature and concrete mix.

Color change is often a common way to determine what temperature concrete has been exposed to. Concrete remains normal in color until it reaches 572°F (300°C) at which it turns pink. Between the temperatures of 572°F-1112° F (300°C-600°C) the aggregate maintains the pink color and darkens to a red. For the range of 1112°F-1742°F (600°C-950°C) the concrete changes to black through gray and then buff. It remains at buff for temperatures thereafter. Specifically the aggregates within the concrete change color as temperature increases. By examining a cross-section of the concrete the temperature depth can also be observed. This is true for all concretes, but some aggregates show better color responses than others. (Georgali and Tsakiridis, 2005)

Another important indicator of temperature in concrete is cracking. Cracking is based on two independent variables, temperature and compressive strength. Guise et al. (1996) determined based on compressive strengths of 8.3 ksi (56.9 MPa), 6.7 ksi (46.4 MPa) and 6.3 ksi (43.6 MPa) that the density of cracking will increase linearly as the temperature increases past a certain point. The point at which cracking will begin and the severity of it is dictated by the compressive strength. Guise et al. also reported that the crack density decreases as the compressive strength increases.

A more serious physical event caused by heating concrete is spalling. Spalling is the deterioration of concrete in large pieces. There are three types of spalling; local spalling ,which is when small pieces break away from the concrete, sloughing off, where medium pieces break away from the concrete, and explosive spalling, which is when large pieces dramatically break away from the concrete. Explosive spalling is most common in high strength concrete because of the low permeability and low porosity. (Ongah et al., 2003)

**2.5.2. Mild Steel.** The reported properties for grade 60 mild reinforcing steel can be seen in Figure 2.3 (Dias, 1992). The modulus of elasticity was found to remain the same for elevated temperatures despite the decrease in tensile strength (Edwards and Gamble, 1986).



**Figure 2.3 Residual strength vs. temperature for mild-reinforcing steel (Dias, 1992)**

**2.5.3. Prestressing Strands.** In contrast to concrete, very little research has been performed to understand how elevated temperatures physically affect the properties of prestressing strands.

**2.5.3.1 Tensile strength.** Guyon (1953) reported the earliest known data regarding the tensile strength of prestressing strands (unreported strand type) exposed to elevated temperatures. The research consisted of hot-stressed, hot-unstressed, cold-stressed and cold-unstressed tests. Temperatures varied by test scenario, but no more than four temperatures were chosen per scenario. The type of strand also varied, 0.2 in. (5.08 mm) cold drawn, 0.2 in. (5.08 mm) rolled, and 0.1 in. (2.54 mm) cold drawn. From the testing performed it was found that for stressed specimens tested while heated there is an initial increase in tensile strength up to 302°F-482°F (150°C-250°C). Thereafter a significant loss of tensile strength occurs. For unstressed specimens tested after cooling, a constant loss in tensile strength occurs as temperature increases. However, the loss in tensile strength is smaller than that of the stressed specimens for temperatures of 572°F

(300°C) and greater. For this test program the heat soak time was also varied. In these cases a greater loss of tensile strength was seen for specimens heated longer.

Abrams and Cruz (1961) performed an in-depth investigation of the behavior of 7-wire, stress-relieved prestressing strands and temperature. Further research for this topic was largely based on the results and conclusions developed by the two researchers. The test program consisted of three seven-wire strand sizes 0.25 in. (6.35 mm), 0.375 in. (22.23 mm), and 0.438 in (11.11 mm). During testing, failure modes were witnessed to be either a few wires breaking, followed by the remainder of the wires breaking singly or all the wires breaking at the same time. Abrams and Cruz noted that although the failure mode varied the data did not differ significantly; therefore the failure modes were acceptable.

Also addressed by the researchers was the rate of heating and cooling. By heating several strands up at various rates and then testing, it was determined that the failure was independent of the heating rate. For the cooling analysis several strands were also heated up and then allowed some to cool “fast” and “slow”. Fast cooling was defined as removing the specimens and placing them under a stream of cold water for 10-20 seconds until they returned to normal temperature. Slow cooling was where the specimen was left in the furnace several hours until it reached normal temperature. Based on tension testing following cooling, it was found that the failure was also independent of the method of which it was cooled.

Abrams and Cruz also performed tension tests on specimens at elevated temperatures. It was found that the tensile strength sharply decreases at 200°F (93°C) and continues until reaching 5 percent residual tensile strength at 1400°F (1860°C).

In 1967 Abrams and Erlin performed a follow-up to the previous research where the effects due to exposure time were examined and hot and cold tensile strengths were compared. For this research 7-wire, stress-relieved prestressing strands were also tested. Exposure times tested were 1 hour, 4 hours and 8 hours. For these exposure times, the residual tensile strengths were found to slightly decrease as the exposure time increased. Overall the 8 hour exposure time produced at residual tensile strength of 90 percent, 60 percent, 41 percent, 32 percent and 29 percent at respective temperatures of 752°F (400°C), 932°F (500°C), 1112°F (600°C), 1300°F (704°C) and 1589°F (865°C). Despite

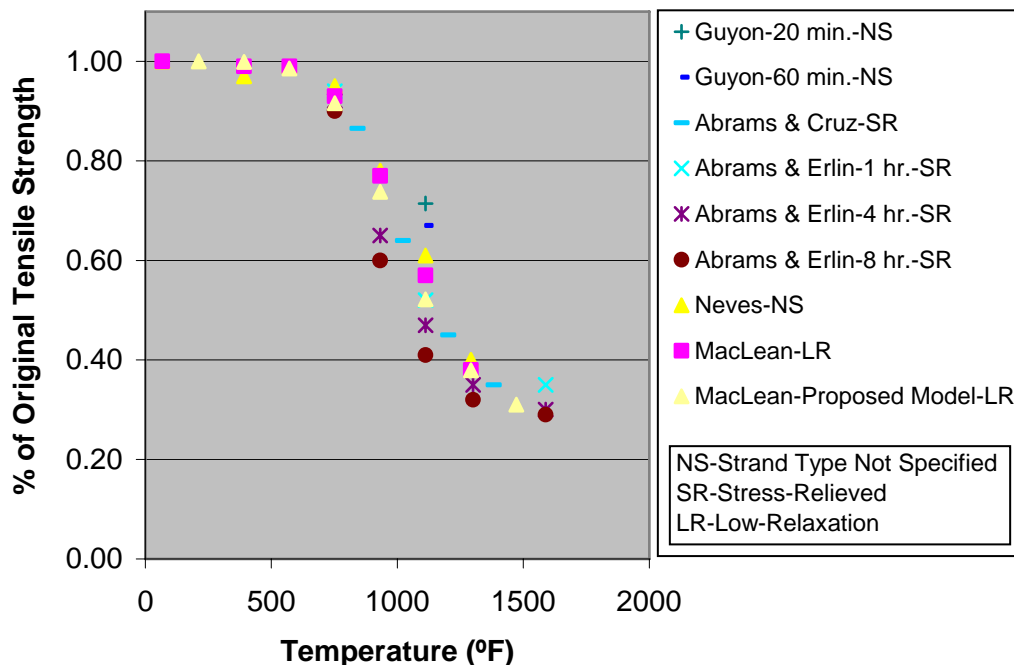
the extended exposure time, residual tensile strengths were approximately 40 percent higher than that of specimens tested at their respective elevated temperature.

Neves et al. (1996) heated a single wire which was cut from the center of the seven-wire prestressing strand. Temperatures examined were in increments of 212°F (100°C) from 392°F-1652°F (200°C-900°C). The specimens were held at their designated temperature for 60 minutes and then were cooled one of two ways, naturally in the furnace with the door opened or immediate immersion in a vessel containing water. The behavior of the tensile strength of the strands initially decreased as reported by Abrams and Guyon. However, at 1472°F (800°C) Neves reported an increase in tensile strength of 8 percent for the specimens cooled naturally in the furnace and an increase of 20 percent for the specimens cooled by water. This result is quite different from that reported by Abrams and Guyon. Neves proposed the increase in tensile strength was due to the differences in steel composition.

A recent study performed by MacLean (2007) replicated the procedure of Abrams and Neves' previous research. MacLean tested single wires cut from the center of seven-wire, low-relaxation prestressing strands. The wires were heated to temperature increments of 212°F (100°C) from 392°F-1652°F (200°C-700°C) and a control 68°F (20°C) and then were held at their designated temperature for 90 minutes. The specimens were then left in the furnace to cool. The results obtained were consistent with Abrams and Guyon. Based on the experimental data and data previously published Equation 2.6 was proposed as a method of determining the residual tensile strength of prestressing strands based on temperature, where  $T$  is in degrees Celsius and  $f_u$  is the ratio of the ultimate tensile strength at a given temperature  $T$ , to the ultimate tensile strength at 68°F (20°C).

$$f_u(T) = 0.25 + \frac{0.75}{1 + (T / 550)^{6.5}} \quad \text{Equation 2.6}$$

A summary of the published residual tensile strength of prestressing strands is shown in Figure 2.4. The notation NS, SR and LR refer to the type of strand. NS is for unspecified strands, SR is stress-relieved strands and LR is low-relaxation strands.



Conversion Units: 1°F = 0.56°C

**Figure 2.4 Residual tensile strength of prestressing strands vs. temperature**

**2.5.3.2 Modulus of elasticity.** The modulus of elasticity was found to be independent of temperature. The property increased slightly as the temperature increased but then decreased back to the undamaged value near the end of testing (Holmes et al., 1982 and McLean, 2007).

**2.5.4. Steel and Concrete Bond Behavior.** Similarly to other materials and mechanisms, there is very little research regarding bond behavior of fire damaged specimens. The earliest known research is quite recent and minimal developments have been produced following this initial study.

In 1972 Harada et al. performed testing on concrete subjected to elevated temperatures. Within the experimental program the bond between reinforcing steel and concrete was examined as it was affected by elevated temperatures. The specimens consisted of concrete cylinders with reinforcing through the middle. They were heated to temperatures of 212°F (100°C), 572°F (300°C) and 842°F (450°C) and held for 72 hours.



It was found that the residual bond to be 44 percent for temperatures 212°F-572°F (100°C-300°C) and 10 percent for 842°F (450°C). It was concluded that bond strength is highly affected by temperature compared to compressive strength.

In 1991 LeClaire published a report regarding the bond strength of epoxy-coated prestressing strands exposed to elevated temperatures. The data was developed by performing pullout tests of specimens exposed to elevated temperatures of 70°F-200°F (21°C-93°C). It was determined from these tests that the bond begins to deteriorate at 125°F (52°C). Failure was found to occur between the epoxy and concrete for temperatures below 100°F (38°C). For temperatures 100°F-160°F (38°C-71°C) softening of the epoxy occurred and at temperatures greater than 175°F (79°C) the bond failure took place between the epoxy and the steel.

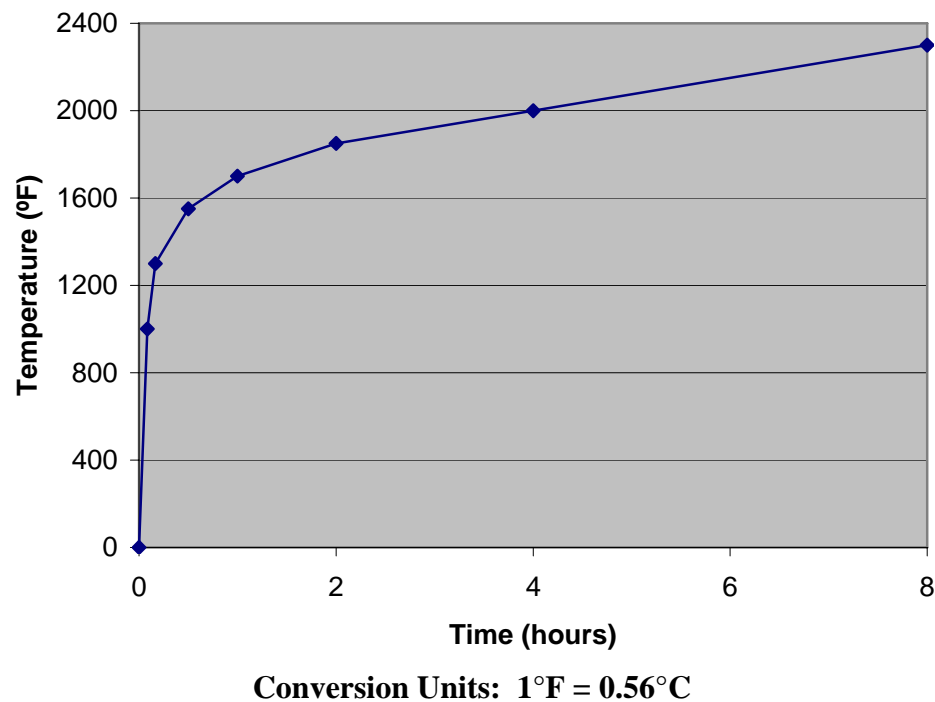
In response to LeClaire's work, the PCI Committee on Epoxy-Coated Strand (1993) released a report which stated that the bond could be lost if a temperature of 165°F (74°C) was reached at the location of the steel-concrete interface. It also noted that when concrete is exposed to higher temperatures, such as a fire, a complete loss in bond may result.

Following the PCI committee report, additional research was performed by Washer and the Federal Highway Administration in 1995. It was confirmed that bond failure begins to occur 160°F (71°C). At 145°F (63°C) initial softening of the epoxy was noticed which later led to the bond failure at higher temperatures.

Most recently researchers out of Taiwan, Chiang et al. (2000), sought to determine the bond strength after fire damage by means of acoustic inspection. Based on current research it was found that the acoustic wave velocity did indicate loss in bond strength due to elevated temperature and increasing time. However, researchers also noted that based on their current results it was inconclusive whether an analysis with acoustic wave velocity in conjunction with a time-temperature analysis is successful in the assessment of residual bond strength.

## 2.6. FIRE MODELS

**2.6.1. Standard Fire Resistance Tests.** Fire tests are performed based on ASTM E119-08, which dictates the temperature, specimen size and duration of the fire. This standard gives a time-temperature curve which can be seen in Figure 2.5. This is the standard to which almost all fire testing is performed by in the United States.



**Figure 2.5 ASTM E 119-08 Standard Time-Temperature Curve**

Based on the guidelines of ASTM E 119-08, a series of tests were performed on various types of beams at the Underwriters Laboratories and Portland Cement Association. This data which is published in the PCI's "Design for Fire Resistance of Precast Prestressed Concrete" (1989) design aid is used to develop temperature profiles

within concrete beams based on the member width and depth within the concrete. These profiles represent the temperature gradient of standard fires for various lengths of time.

For concrete slabs, the temperature profile is significantly different due to their continuous geometry. Abrams and Gustaferro (1968) used the ASTM E 119-08 standard time-temperature curve to determine the temperature profiles in slabs. The testing was performed on three types of aggregate, carbonate, siliceous and shale. Temperature within the concrete was measured by thermocouples at time increments of 1/2, 1, 2, 3, 4 hours. The shale was found to have the longest endurance periods followed by the carbonate and then siliceous. This data can also be used to determine the temperature profile within a concrete slab.

**2.6.2. Non-Standard Fires.** For fires that are caused by fuel or explosives the flame temperature will be higher and will occur more rapidly than that specified by the standard time-temperature curve. Due to the standard, there is no data that exists for these scenarios. Therefore hand calculation and computer modeling must be used to simulate these situations.

**2.6.2.1 Pool fires.** In the case that a fire is caused by a fuel spill, there are published guidelines for prediction of the size and duration of the fire. A series of equations have been developed which vary based on the type of chemical, surface of which it is spilled onto and confinement of spill. For an instantaneous unconfined spill, Equation 2.7 quantifies the maximum diameter,  $D_{max}$ , of the fire (Zalosh, 1984). For this equation,  $V_L$  is the volume of the spill,  $y$  is the liquid burning rate and  $g$  is acceleration of gravity. Values for the liquid burning rate are reported by the SFPE Handbook of Fire Protection Engineering (2<sup>nd</sup> Ed., 1995).

$$D_{max} = 2 \left( \frac{V_L^3 g}{y^2} \right)^{\frac{1}{8}} \quad \text{Equation 2.7}$$

The length of time that a pool fire will burn can be determined by Equation 2.8, where  $\nu$  is the regression rate. The regression rate is defined in Equation 2.9 where  $\dot{m}''$  is the mass burning rate of fuel per unit area and  $\rho$  is the liquid fuel density (Iqbal and Salley, 2004).

$$t = \frac{4V_L}{\pi D^2 \nu} \quad \text{Equation 2.8}$$

$$\nu = \frac{\dot{m}''}{\rho} \quad \text{Equation 2.9}$$

Flame temperatures are difficult to measure due to the non-uniformity throughout the flame. Researchers however, have determined that the flame is made up of two main temperature regions, the lower region which is typically constant and the tip which decreases with distance up the plume. Temperatures within the lower region are typically around 1652°F (900°C) and within the tip are typically around 842°F (450°C). However, for larger pools the lower region may rise up 2192°F (1200°C). (Iqbal and Salley, 2004; Ingason, 1994; Qian and Saito, 1995). Average flame temperatures for selected fuels are reported by Iqbal and Salley (2004). Specifically, gasoline is reported to have an average flame temperature of 1879°F (1026°C).

Temperatures of actual bridge fires have also been recorded based on concrete color and melted objects. A gasoline fire near Ridgefield, Connecticut was estimated to have burned at a temperature of 4473°F (2467°C) (FHWA, 2007). In another fire in Tacoma, Washington, experts approximated the fire around 3000°F (1649°C) (*Aspire*, Spring 2008). These results indicate that there is often a significant difference between the average flame temperature and peak temperature.

**2.6.2.2 Modeling.** Recently, the use of modeling in the application of fire modeling has been quickly increasing. There is a constant competition to develop methods and products which accurately and efficiently solve engineering problems. In particular the finite element modeling (FEM) of temperature profiles in concrete is quite often studied. Several methods have been produced but as of yet very little research has been performed to verify their accuracy for high temperatures.

One of the first models developed was by Wickstrom (1986). This model which is considered to be “very simple” used the data already developed from standard fire curves to predict the temperature profile within concrete. This method however, can only

be applied to structures exposed to temperatures within the standard time-temperature curve.

Another approach published by Wang and Tan (2005) used a method called the “Residual Area Method” to determine the temperature profile for concrete-encased I-sections. From this method, a series of formulas are given to calculate the critical temperature along the steel profile.

As part of a thermal behavior analysis of a FRP deck, Alnahhal et al. (2006) employed the use of ABAQUS, a finite element computer modeling software package. The result produced by ABAQUS was compared to actual testing on an existing bridge. The findings were that the results from both sources were quite similar and that the software was accurate in predicting the temperature within the concrete.

## 2.7. FIRE DAMAGED STRUCTURES

Data regarding the structural integrity of prestressed concrete bridges is limited to information obtained from damaged bridges. In some cases this information only includes the visual observations of a bridge following fire. In other cases the bridge is torn down and laboratory testing is performed to understand the material properties.

In recent bridge fire incidents, engineers have been able to inspect the bridge after fire and approve them to be in service upon minimal repairs. Despite the appearance of the fire, inspection indicated that the structural integrity was still acceptable. In particular the Bill Williams Bridge in Parker, Arizona (shown in Figure 2.6), the Northwest Expressway in Oklahoma City, Oklahoma and a bridge in Washington County, Oregon are all examples of bridges which were inspected and then reopened days later. Minimal repairs were performed on the bridges. (*Aspire*, Spring 2008).

In the case of laboratory testing of a damaged bridge, the bridge over the Norwalk River near Ridgefield, Connecticut (shown in Figure 2.7) gives significant insight on the fire-damaged properties of a prestressed concrete bridge. Upon damage the bridge was torn down and taken to the laboratory where it was examined more closely. It was determined that the flexural capacity of the beams exceeded their rate capacities and would have been sufficient in service following the fire. However, the long term

durability and integrity of the beams were in question due to the severe deterioration of the concrete. (FHWA, 2007)



**Figure 2.6 Fire along the Bill Williams Bridge in Parker, Arizona due to an overturned diesel tanker (Aspire, Spring 2008)**



**Figure 2.7 Damaged Norwalk Bridge near Ridgefield, Connecticut due to an overturned gasoline tanker (FHWA, 2007)**

### 3. EXPERIMENTAL PROGRAM

#### 3.1. TEST MATRIX

For this experimental program, two different tests were performed, tension and pullout. Both tests were performed after the strands had been exposure to different levels of elevated temperature. The tension testing was used to analyze the tensile strength and stiffness properties of the prestressing strand after damage, while the pullout testing was performed to understand the bond between the strand and concrete after damage.

Seven-wire, uncoated, grade 270 ksi (1862 MPa), low-relaxation strands of two sizes, 0.5 in. (12.7 mm) and 0.375 in. (9.5 mm), were employed in testing. The same temperatures were used for both tension and pullout tests in order to obtain correlating results. The temperatures selected for the study were 500°F (260°C), 800°F (427°C), 1000°F (538°C), 1200°F (649°C), and 1300°F (704°C). In addition, control specimens were tested for each strand size. A control was defined as exposure to approximately 68°F (20°C). These temperatures were chosen because previous research shown in Section 2.5.3 has indicated reinforcing steel to experience significant loss in tensile strength soon after reaching 800°F (427°C). The upper limit was defined by the furnace's capability.

**3.1.1. Tension Tests.** Within the tension tests there were two phases of testing. Phase I was designed to understand the tensile strength of the strand at elevated temperatures. It also considered effects due to the method of cooling. Phase II of the experiment examined the tensile strength properties due to a shorter time of heat exposure (heat soak).

Test matrices for Phase I and II can be seen in Tables 3.1-3.4. The Specimen ID given in each table is given in the format of A-B-C-D-E, where the A designates the phase number, B designates the strand size, C specifies the temperature level, D gives the cooling method and E designates the replicate of that specimen set. The label B is used to designate strand size with "1" for 0.375 in. and "2" for 0.5 in. The C designation is given by numbers 1-6, which refer to the temperature levels beginning with the control as

“1” and continuing up to 1300°F (704°C) which is given as “6”. The D designation for the cooling method is denoted by “1” for cooling outside the furnace and “2” for cooling inside the furnace.

**Table 3.1 Tension test matrix Phase I: 0.375 in. strand diameter**

Specimen ID	Temperature, °F (°C)	Heat Soak Time, min	Cooling Method
1-1-1-1-1	Control	60	Outside Furnace
1-1-1-1-2	Control	60	Outside Furnace
1-1-1-1-3	Control	60	Outside Furnace
1-1-2-1-1	500 (260)	60	Outside Furnace
1-1-2-1-2	500 (260)	60	Outside Furnace
1-1-2-1-3	500 (260)	60	Outside Furnace
1-1-3-1-1	800 (427)	60	Outside Furnace
1-1-3-1-2	800 (427)	60	Outside Furnace
1-1-3-1-3	800 (427)	60	Outside Furnace
1-1-4-1-1	1000 (538)	60	Outside Furnace
1-1-4-1-2	1000 (538)	60	Outside Furnace
1-1-4-2-1	1000 (538)	60	Inside Furnace
1-1-4-2-2	1000 (538)	60	Inside Furnace
1-1-5-1-1	1200 (649)	60	Outside Furnace
1-1-5-1-2	1200 (649)	60	Outside Furnace
1-1-5-2-1	1200 (649)	60	Inside Furnace
1-1-5-2-2	1200 (649)	60	Inside Furnace
1-1-6-1-1	1300 (704)	60	Outside Furnace
1-1-6-1-2	1300 (704)	60	Outside Furnace
1-1-6-2-1	1300 (704)	60	Inside Furnace
1-1-6-2-2	1300 (704)	60	Inside Furnace



**Table 3.2 Tension test matrix Phase I: 0.5 in. strand diameter**

Specimen ID	Temperature, °F (°C)	Heat Soak Time, min	Cooling Method
1-2-1-1-1	Control	60	Outside Furnace
1-2-1-1-2	Control	60	Outside Furnace
1-2-1-1-3	Control	60	Outside Furnace
1-2-2-1-1	500 (260)	60	Outside Furnace
1-2-2-1-2	500 (260)	60	Outside Furnace
1-2-2-1-3	500 (260)	60	Outside Furnace
1-2-3-1-1	800 (427)	60	Outside Furnace
1-2-3-1-2	800 (427)	60	Outside Furnace
1-2-3-1-3	800 (427)	60	Outside Furnace
1-2-4-1-1	1000 (538)	60	Outside Furnace
1-2-4-1-2	1000 (538)	60	Outside Furnace
1-2-4-1-3	1000 (538)	60	Outside Furnace
1-2-4-2-1	1000 (538)	60	Inside Furnace
1-2-4-2-2	1000 (538)	60	Inside Furnace
1-2-4-2-3	1000 (538)	60	Inside Furnace
1-2-5-1-1	1200 (649)	60	Outside Furnace
1-2-5-1-2	1200 (649)	60	Outside Furnace
1-2-5-1-3	1200 (649)	60	Outside Furnace
1-2-5-2-1	1200 (649)	60	Inside Furnace
1-2-5-2-2	1200 (649)	60	Inside Furnace
1-2-5-2-3	1200 (649)	60	Inside Furnace
1-2-6-1-1	1300 (704)	60	Outside Furnace
1-2-6-1-2	1300 (704)	60	Outside Furnace
1-2-6-1-3	1300 (704)	60	Outside Furnace
1-2-6-2-1	1300 (704)	60	Inside Furnace
1-2-6-2-2	1300 (704)	60	Inside Furnace
1-2-6-2-3	1300 (704)	60	Inside Furnace

**Table 3.3 Tension test matrix Phase II: 0.375 in. strand diameter**

Specimen ID	Temperature, °F (°C)	Heat Soak Time, min	Cooling Method
2-1-4-1-1	1000 (538)	35	Outside Furnace
2-1-4-1-2	1000 (538)	35	Outside Furnace
2-1-4-1-3	1000 (538)	35	Outside Furnace
2-1-5-1-1	1200 (649)	35	Outside Furnace
2-1-5-1-2	1200 (649)	35	Outside Furnace
2-1-5-1-3	1200 (649)	35	Outside Furnace
2-1-6-1-1	1300 (704)	35	Outside Furnace
2-1-6-1-2	1300 (704)	35	Outside Furnace
2-1-6-1-3	1300 (704)	35	Outside Furnace

**Table 3.4 Tension test matrix Phase II: 0.5 in. strand diameter**

Specimen ID	Temperature, °F (°C)	Heat Soak Time, min	Cooling Method
2-2-4-1-1	1000 (538)	35	Outside Furnace
2-2-4-1-2	1000 (538)	35	Outside Furnace
2-2-4-1-3	1000 (538)	35	Outside Furnace
2-2-5-1-1	1200 (649)	35	Outside Furnace
2-2-5-1-2	1200 (649)	35	Outside Furnace
2-2-5-1-3	1200 (649)	35	Outside Furnace
2-2-6-1-1	1300 (704)	35	Outside Furnace
2-2-6-1-2	1300 (704)	35	Outside Furnace
2-2-6-1-3	1300 (704)	35	Outside Furnace

**3.1.1.1 Phase I.** For the control, 500°F (260°C) and 800°F (427°C), three (3) coupons per strand size were heated and tested. These specimens were cooled by removing them from the furnace. For the higher temperatures, 1000°F (538°C), 1200°F (649°C), and 1300°F (704°C), six (6) coupons were heated for the 0.5 in. diameter strands and four (4) were heated for the 0.375 in. diameter strands. The increase in

number of strands was to observe the effects due cooling. Three (3) of the 0.5 in. and two (2) of the 0.375 in. were cooled inside the furnace and the remaining three (3) 0.5 in. and two (2) 0.375 in. were cooled by removing them from the furnace. All strands were held at their specific temperature for 60 minutes. This particular length of time was chosen, because much of the research of the same type of testing used this time period (Abrams and Erlin, 1967; Neves et al., 1996).

**3.1.1.2 Phase II.** In addition to Phase I, additional testing was also performed where the specimens were held at their desired temperature for 35 minutes. The decrease in heat soak time was due to interest in the materials properties for specimens exposed to elevated temperatures for shorter periods of time. Research by Guyon (1953) indicated that property loss was lower for shorter periods of heat exposure.

For this phase, three (3) temperatures were studied, 1000°F (538°C), 1200°F (649°C) and 1300°F (704°C). Three (3) strands per temperature were tested for both the 0.5 in. and 0.375 in. size strands. The specimens were removed from the furnace and cooled naturally.

**3.1.2. Pullout Tests.** In the pullout testing, two different concrete mix designs mixes were used. The first batch of specimens used an 11 ksi (76 MPa) design mix and the second batch used a 14 ksi (97 MPa) design mix.

The Specimen ID given for each specimen is in the format of A-B-C-D, where the A designates compressive strength of the concrete, B designates the strand size, C designates the temperature level and D specifies the replicate of the specimen set. Similarly to the tension testing, B is used to designate strand size with 1 for 0.375 in. and 2 for 0.5. Also the temperature level designated by C is given by numbers 1-6, which refer to the temperature levels beginning with the control as 1 and continuing up to 1300°F (704°C) which is given as 6.

The test matrix for the 11 ksi specimens can be seen in Table 3.5. A total of thirty-six (36) concrete blocks were tested, eighteen (18) of 0.5 in. diameter and eighteen (18) of 0.375 in. diameter. For each temperature three (3) strands of each diameter were heated and tested. After the 60 minute period of heat exposure, these specimens were removed from the furnace and cooled naturally.

**Table 3.5 Pullout test matrix for 11 ksi concrete specimens**

0.375 in. Specimens		0.5 in. Specimens	
Specimen ID	Temperature, °F (°C)	Specimen ID	Temperature, °F (°C)
11-1-1-1	Control	11-2-1-1	Control
11-1-1-2	Control	11-2-1-2	Control
11-1-1-3	Control	11-2-1-3	Control
11-1-2-1	500 (260)	11-2-2-1	500 (260)
11-1-2-2	500 (260)	11-2-2-2	500 (260)
11-1-2-3	500 (260)	11-2-2-3	500 (260)
11-1-3-1	800 (427)	11-2-3-1	800 (427)
11-1-3-2	800 (427)	11-2-3-2	800 (427)
11-1-3-3	800 (427)	11-2-3-3	800 (427)
11-1-4-1	1000 (538)	11-2-4-1	1000 (538)
11-1-4-2	1000 (538)	11-2-4-2	1000 (538)
11-1-4-3	1000 (538)	11-2-4-3	1000 (538)
11-1-5-1	1200 (649)	11-2-5-1	1200 (649)
11-1-5-2	1200 (649)	11-2-5-2	1200 (649)
11-1-5-3	1200 (649)	11-2-5-3	1200 (649)
11-1-6-1	1300 (704)	11-2-6-1	1300 (704)
11-1-6-2	1300 (704)	11-2-6-2	1300 (704)
11-1-6-3	1300 (704)	11-2-6-3	1300 (704)

The 14 ksi specimens can be seen in Table 3.6. Thirty (30) concrete blocks were tested, eighteen (18) of 0.5 in. diameter and twelve (12) of 0.375 in. diameter. For this batch, three (3) 0.5 in. diameter specimens and two (2) 0.375 in. diameter specimens were heated for each temperature. Similarly, to the 11 ksi specimens, the 14 ksi specimens were cooled naturally outside of the furnace after the 60 minute heat soak period was completed.

**Table 3.6 Pullout test matrix for 14 ksi concrete specimens**

0.375 in. Specimens		0.5 in. Specimens	
Specimen ID	Temperature, °F (°C)	Specimen ID	Temperature, °F (°C)
14-1-1-1	Control	14-2-1-1	Control
14-1-1-2	Control	14-2-1-2	Control
14-1-2-1	500 (260)	14-2-1-3	Control
14-1-2-2	500 (260)	14-2-2-1	500 (260)
14-1-3-1	800 (427)	14-2-2-2	500 (260)
14-1-3-2	800 (427)	14-2-2-3	500 (260)
14-1-4-1	1000 (538)	14-2-3-1	800 (427)
14-1-4-2	1000 (538)	14-2-3-2	800 (427)
14-1-5-1	1200 (649)	14-2-3-3	800 (427)
14-1-5-2	1200 (649)	14-2-4-1	1000 (538)
14-1-6-1	1300 (704)	14-2-4-2	1000 (538)
14-1-6-2	1300 (704)	14-2-4-3	1000 (538)
		14-2-5-1	1200 (649)
		14-2-5-2	1200 (649)
		14-2-5-3	1200 (649)
		14-2-6-1	1300 (704)
		14-2-6-2	1300 (704)
		14-2-6-3	1300 (704)

## 3.2. MATERIALS

**3.2.1. Prestressing Strands.** The specimens selected for the experiment were uncoated seven-wire low-relaxation prestressing strands of grade 270 ksi (1862 MPa). Two (2) sizes of wires were used, 0.5 in. (12.7 mm) and 0.375 in. (9.53 mm), with cross-sectional areas of 0.153 in<sup>2</sup> and 0.085 in<sup>2</sup> respectively. The standard ASTM A 416/A 416M-06 provides required properties for this type of prestressing strand. In order for a

strand to be acceptable for use in construction and certified by its supplier the yield stress and minimum fracture strength must be met. These values are also used to verify testing procedures used in experimental research. These standard properties given by ASTM A 416/A 416M-06 are shown in Table 3.7.

**Table 3.7 Mechanical properties of prestressing strands**

	Area, in <sup>2</sup> (mm <sup>2</sup> )	Yield Stress, ksi (MPa)	Fracture Stress, ksi (MPa)	Minimum Fracture Strength, lbf (kN)	Modulus of Elasticity, ksi (MPa)
<b>0.5 in.</b>	0.153 (12.7)	243 (1675)	270 (1862)	41,300 (183.7)	28,500 (196,500)
<b>0.375 in.</b>	0.085 (9.53)	243 (1675)	270 (1860)	23,000 (102.3)	28,500 (196,500)

**3.2.2. Concrete.** The pullout specimens were made up of two (2) different mix designs. These mix designs and reported compressive strengths at 7 days and the time of testing can be seen in Table 3.8.

**Table 3.8 Mix design and strength properties of concrete pullout specimens**

Mix Design Material Batch Weights	Batch 1 - lbs (N)	Batch 2 - lbs (N)
Portland Cement-Type III	47.0 (209.1)	109.7 (487.9)
Portland Cement Type I	-	94.0 (418.1)
Silica Fume	8.2 (36.5)	17.8 (79.2)
Coarse Aggregate	123.0 (547.1)	-
1/2" Clean Aggregate	49.2 (218.8)	218.9 (973.7)
3/8" Clean Aggregate	-	93.8 (417.2)
Manufactured Sand	-	51.2 (227.7)
Concrete Sand	-	261.1 (1161.3)
Fine Aggregate	149.7 (665.9)	-
Mix Water	28.2 (125.4)	66.1 (294.0)
HRWA (oz)	12.3 (54.7)	34.6 (153.9)
<b>7-Day Strength - psi (MPa)</b>	<b>6,900 (47.6)</b>	<b>11,480 (79.2)</b>
<b>Strength During Testing - psi (MPa)</b>	<b>11,230 (77.4)</b>	<b>14,330 (98.8)</b>

### 3.3. DESCRIPTION OF SPECIMENS

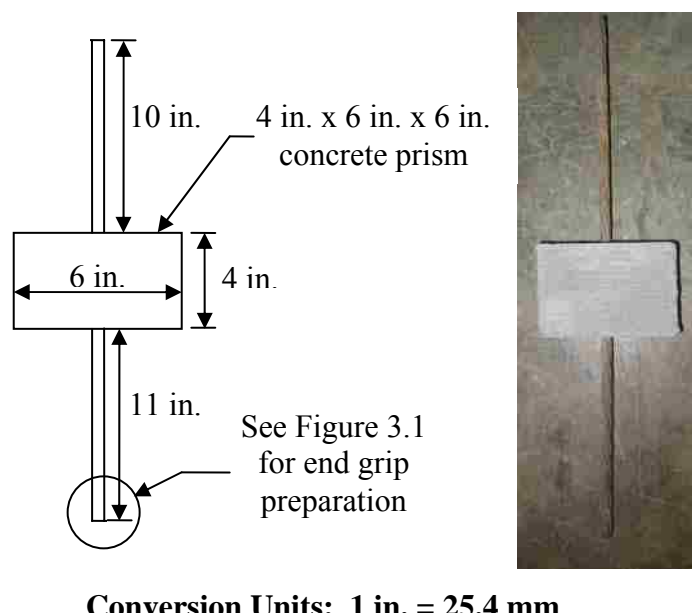
**3.3.1. Tension Specimens.** The coupon specimens were cut into lengths of 18 in. (457.2 mm), a value based on ASTM A416M-06, the grip length of the jaws, and the furnace dimensions. Nothing additional was applied or performed on the prestressing strands prior to exposure to elevated temperatures. A schematic and actual view of the specimen is given in Figure 3.1.



**Conversion Units: 1 in. = 15.2 cm**

**Figure 3.1 Schematic and actual view of coupon specimen**

**3.3.2. Pullout Specimens.** The pullout specimens consisted of a 25 in. (635 mm) prestressing strand cast in the center of a 6 in. x 6 in. x 4 in. (152.4 mm x 152.4 mm x 101.6 mm) concrete block. A length of 4 in. (101.6 mm) was embedded in the concrete. The remaining portion of the strand was exposed with 10 in. (254 mm) above and 11 in. (279.4 mm) below the concrete block. This concrete block geometry and embedment length was similar to experimental work by Chao (2005). This was done in order to compare and correlate experimental data with published results from Chao. A schematic and actual view of the specimen can be seen in Figure 3.2.



**Figure 3.2 Schematic and actual view of pullout specimen**

### 3.4. TEST SETUP

**3.4.1. Furnace.** In order to simulate fire damage, the specimens were placed inside a cylindrical tube furnace and heated to their designated temperature at a rate of approximately 8°F/min (4.4°C/min). The temperature was measured by a thermocouple which was directly linked to the temperature controller.

For the first set of coupons, the temperature was increased until it reached its designated value and then held for 60 minutes, allowing a uniform temperature to be reached. The specimens that were to be cooled outside the furnace were then removed, placed at room temperature and allowed to cool. The furnace was turned off and the remaining specimens were left in furnace and cooled as the furnace naturally cooled down. The second set of coupons were heated in the same manner, but only held at their specific temperature for 35 minutes. They were cooled outside the furnace after their heat soak was completed. As discussed in Section 3.1.1, the heat soak time period of 60 minutes was based on previous research of similar tests (Abrams and Erlin, 1967; Neves et al., 1996) and the 35 minute period was chosen to research the affects caused by a shorter period of exposure time.



For the pullout specimens the exposed portions of the strand were wrapped in wool fiber and aluminum foil. This was done to protect the properties of the strand and ensure failure would occur between the bond of the strand and concrete before the steel fractured. These were also heated for 60 minutes at their specified temperature.

When heating the coupon specimens, all six of each temperature were placed in the furnace at the same time. The pullout specimens were heated two at a time due to the allowable space in the furnace. The furnace and heating setup can be seen in Figures 3.3 and 3.4. The white blocks shown in Figure 3.4 were oven bricks which were used elevate the coupon specimens in the furnace and keep them from touching one another during heating.



**Figure 3.3 Cylindrical tube furnace**



**Figure 3.4 Typical heating setup**

**3.4.2. Tension Tests.** Tensile testing was performed using a MTS880 machine as shown in Figure 3.5. Load, strain, and stroke were electronically recorded for each specimen. In order to achieve equal grip strength around the strands, a 3 in. (76.2 mm) long aluminum tube made of aluminum alloy 6061 with a thickness of 0.049 in. was placed on both ends of the coupon. For the 0.5 in. strands a 0.5 in. (12.7 mm) outside diameter, 0.527 in. (13.39 mm) inside diameter aluminum tube was used. The 0.375 in. strands employed a 0.625 in. (15.88) outside diameter, 0.402 in. (10.21 mm) inside diameter aluminum tube. This allowed the grips to squeeze the aluminum into the gaps between the individual wires and prevent slipping or premature fracture. A small weld was also placed at the ends of each specimen to ensure the strands were loaded uniformly. Gripping strength was set at 7.5 ksi (51.8 MPa) for the 0.5 in. specimens and 6 ksi (41.4 MPa) for the 0.375 in. specimens. A typical specimen placed in the MTS880 machine can be seen in Figure 3.6.



Figure 3.5 MT880 testing machine prior to tension tests



Figure 3.6 Tension test setup

The procedure for the coupon testing began by centering the specimen inside the testing machine. The specimen was loaded to an initial load of 10 percent of the minimum breaking strength as specified by ASTM A416M-06 and ASTM A307-07a. A Class-C extensometer was then placed on the strand and the gauge reading was set to 0.001 in./in. (0.0254 mm/mm). Loading rates for each strand diameter were selected to be 23 percent of the maximum acceptable load set by ASTM 370-07a. These values were based on the standard's allowable range and testing machine's capabilities. Initial loads and load rates can be seen in Table 3.9.

**Table 3.9 Testing properties of prestressing strands**

<b>Strand Diameter</b> <b>in. (mm)</b>	<b>Initial Load</b> <b>lbf (kN)</b>	<b>Loading Rate</b> <b>lbs/min (kN/min)</b>
0.5 (12.7)	4,130 (18.4)	3,470 (15.44)
0.375 (9.5)	2,300 (10.2)	1,930 (8.59)

Loading continued until yielding took place. The extensometer was then removed in order to prevent damage to itself during fracture. For specimens unexposed to the furnace the yield was taken at an elongation of 1 percent which was recorded by the machine as a strain value of 0.01 in./in. (0.254 mm/mm). This procedure was in accordance with ASTM A416M-06. For the heat-exposed specimens yield occurred much sooner and the extensometer was removed once the curve on the computer clearly changed slope signifying a yield. During and after the removal of the extensometer, the loading continued and was completed when the specimen fractured. For certain cases, particularly the higher temperatures, a clear change in slope was not recognizable and therefore the extensometer was left on the specimen until failure.

**3.4.3. Pullout Tests.** There are no governing specifications regarding pullout testing for prestressing strands in bridge applications. Therefore, testing was performed in a similar fashion to that of an experiment performed by Chao (2005).

The testing procedure was performed on the same MTS880 machine used for tension testing. A steel pullout testing cage was loaded into the top grips of the machine as shown in Figures 3.7 and 3.8. The cage itself was 32 in. (81.3 cm) tall and 24 in. (61.0 cm) by 20 in. (50.8 cm) wide. A 1 in. (2.5 cm) wide plate shown in Figure 3.9 was welded onto the base of the cage for the perimeter of the concrete to bear on. The plate was located along the perimeter of the block to avoid splitting effects. As seen in Figure 3.10 the concrete specimen sat flat on the welded plate and the strand fit through the hole and was secured in the bottom grip of the MTS880. The specimens were monotonically loaded under stroke control at a rate of 0.001 in. slip per second (0.025 mm slip/second). Load and slip were recorded for the entire test until failure. Failure was taken at specimen fracture or if it did not fracture failure was taken at a slip of 3 in. (76.2 mm).



**Figure 3.7 Pullout test setup cage prior to testing**



**Figure 3.8 Pullout test setup with specimen inside steel cage**



**Figure 3.9 Base of pullout cage which concrete block was pulled against**



**Figure 3.10** Enlarged view of pullout test setup with specimen inside steel cage

## 4. EXPERIMENTAL TEST RESULTS

### 4.1. TENSION TESTS

**4.1.1. Visual Observations.** Visual observations of the prestressing strands were made prior to testing and can be seen in Figures 4.1-4.5. Noticeable changes to the strand's appearance were first observed with the specimens exposed to 1000°F (538°C). These coupons' shiny appearance was replaced by a dark dull appearance which indicates the beginning of steel oxidation. The strands heated to 1200°F (649°C) were also found to be dull and in addition their exterior coating began to slightly flake off. Finally the specimens of 1300°F (704°C) showed significant flaking of the exterior and dullness. Note the shiny areas in Figure 4.5 are parts of the strand where the exterior flaked off after heating during transport. Coupons exposed to 500°F (260°C) and 800°F (427°C) remained the same as they were prior to heating, with an exterior characterized by a shiny appearance. These observations were the same for each temperature regardless of the type of cooling method or length of heat soak.



**Figure 4.1 Strand exterior after exposure to 500°F (260°C)**



**Figure 4.2 Strand exterior after exposure to 800°F (427°C)**





**Figure 4.3 Strand exterior after exposure to 1000°F (538°F)**



**Figure 4.4 Strand exterior after exposure to 1200°F (649°F)**



**Figure 4.5 Strand exterior after exposure to 1300°F (704°C)**

**4.1.2. Test Results.** The results of the tension tests are presented in this section. For each of the tests, stroke and load were recorded for the entire loading period. Strain was recorded until at least the yield point as discussed earlier. Tables 4.1-4.5 contain the yield stress, ultimate load, modulus of elasticity (abbreviated as “Modulus of E.”) and the standard deviation for each of three previously mentioned properties.

**Table 4.1 Test results Phase I: 0.375 in. strand diameter**

Specimen ID	Yield Stress,	Ultimate Load,	Modulus of	Standard Deviation
	ksi (MPa) A	kips (kN) B	Elasticity, ksi (MPa) C	A: Yield Stress B: Ultimate Load C: Modulus of E.
1-1-1-1-1	253 (1,744)	24.0 (106.8)	24,413 (168,322)	A: 1.85 (12.8)
1-1-1-1-2	256 (1,765)	24.2 (107.6)	26,769 (184,566)	B: 0.10 (0.4)
1-1-1-1-3	257 (1,772)	24.3 (108.1)	26,513 (182,801)	C: 1,055.5 (7,277.4)
1-1-2-1-1	244 (1,682)	24.1 (107.2)	28,048 (193,384)	A: 0.91 (6.3)
1-1-2-1-2	246 (1,696)	24.1 (107.2)	27,821 (191,819)	B: 0.12 (0.5)
1-1-2-1-3	245 (1,689)	23.9 (106.3)	27,920 (192,502)	C: 92.9 (640.5)
1-1-3-1-1	212 (1,462)	21.1 (93.9)	26,966 (185,924)	A: 0.50 (3.4)
1-1-3-1-2	210 (1,448)	21.6 (96.1)	28,379 (195,666)	B: 0.20 (0.9)
1-1-3-1-3	211 (1,455)	21.5 (95.6)	28,354 (195,494)	C: 660.3 (4,552.6)
1-1-4-1-1	187 (1,289)	15.9 (70.7)	26,267 (181,105)	A: 0.31 (2.1)
1-1-4-1-2	186 (1,282)	15.8 (70.3)	27,211 (187,613)	B: 0.03 (0.1)
1-1-4-2-1	185 (1,276)	15.7 (69.8)	24,994 (172,328)	C: 472.0 (3,254.3)
1-1-4-2-2	186 (1,282)	15.8 (70.3)	25,462 (175,554)	A: 0.67 (4.6)
1-1-5-1-1	119 (820)	10.1 (44.9)	24,280 (167,405)	B: 0.06 (0.3)
1-1-5-1-2	117 (807)	9.9 (44.0)	27,242 (187,827)	C: 234.0 (1,613.4)
1-1-5-2-1	119 (820)	10.1 (44.9)	26,744 (184,393)	A: 1.11 (7.7)
1-1-5-2-2	119 (820)	10.1 (44.9)	25,735 (177,437)	B: 0.09 (0.4)
1-1-6-1-1	100 (689)	8.5 (37.8)	24,849 (171,328)	C: 1,481.0 (10,211.1)
1-1-6-1-2	102 (703)	8.7 (38.7)	24,494 (168,880)	A: 0.12 (0.8)
1-1-6-2-1	101 (696)	8.6 (38.3)	25,856 (178,271)	B: 0.01 (0.04)
1-1-6-2-2	101 (696)	8.6 (38.3)	25,147 (173,383)	C: 504.5 (3,478.4)

**Table 4.2 Test results Phase I: 0.5 in. strand diameter**

Specimen ID	Yield Stress,	Ultimate Load,	Modulus of	Standard Deviation
	ksi (MPa) A	kips (kN) B	Elasticity, ksi (MPa) C	A: Yield Stress B: Ultimate Load C: Modulus of E.
1-2-1-1-1	251 (1,731)	42.1 (187.3)	25,246 (174,065)	A: 1.15 (7.9)
1-2-1-1-2	251 (1,731)	43.2 (192.2)	25,464 (175,568)	B: 0.57 (2.5)
1-2-1-1-3	248 (1,710)	41.7 (185.5)	27,237 (187,793)	C: 772.2 (5324.1)
1-2-2-1-1	242 (1,669)	40.2 (178.8)	26,678 (183,938)	A: 1.24 (8.5)
1-2-2-1-2	244 (1,682)	41.4 (184.2)	27,164 (187,289)	B: 0.47 (2.1)
1-2-2-1-3	245 (1,689)	40.2 (178.8)	27,931 (192,578)	C: 446.7 (3,079.9)
1-2-3-1-1	232 (1,600)	37.6 (167.3)	26,329 (181,532)	A: 1.02 (7.03)
1-2-3-1-2	235 (1,620)	36.5 (162.4)	25,587 (176,416)	B: 0.41 (1.8)
1-2-3-1-3	235 (1,620)	37.3 (165.9)	26,799 (184,773)	C: 432.1 (2,979.2)
1-2-4-1-1	185 (1,276)	28.3 (125.9)	28,885 (199,155)	A: 0.80 (5.5)
1-2-4-1-2	186 (1,282)	28.4 (126.3)	26,995 (186,124)	B: 0.12 (0.5)
1-2-4-1-3	184 (1,269)	28.1 (125.0)	26,268 (181,112)	C: 955.2 (6,585.9)
1-2-4-2-1	192 (1,324)	29.4 (129.9)	25,568 (176,285)	A: 3.30 (22.8)
1-2-4-2-2	184 (1,269)	28.1 (125.0)	24,814 (171,087)	B: 0.50 (2.2)
1-2-4-2-3	191 (1,317)	29.2 (129.9)	23,735 (163,647)	C: 651.5 (4,491.9)
1-2-5-1-1	115 (793)	17.6 (78.3)	30,884 (212,938)	A: 2.12 (14.6)
1-2-5-1-2	110 (758)	16.9 (75.2)	26,260 (181,056)	B: 0.32 (1.4)
1-2-5-1-3	109 (752)	16.7 (74.3)	25,543 (176,113)	C: 2,049.8 (14,132.9)
1-2-5-2-1	105 (724)	16.1 (71.6)	23,260 (160,372)	A: 1.74 (12.0)
1-2-5-2-2	105 (724)	16.0 (71.2)	24,601 (169,618)	B: 0.27 (1.2)
1-2-5-2-3	109 (752)	16.7 (74.3)	21,230 (146,376)	C: 1,200.1 (8,274.4)
1-2-6-1-1	99 (683)	15.1 (67.2)	25,825 (178,057)	A: 3.16 (21.8)
1-2-6-1-2	97 (669)	14.8 (65.8)	25,005 (172,403)	B: 0.48 (2.1)
1-2-6-1-3	105 (724)	16.1 (71.6)	28,831 (198,783)	C: 1,424.4 (9,820.9)
1-2-6-2-1	102 (703)	15.6 (69.4)	22,928 (158,083)	A: 1.68 (11.6)
1-2-6-2-2	98 (676)	15.0 (66.7)	25,323 (174,596)	B: 0.26 (1.2)
1-2-6-2-3	97 (669)	14.9 (66.3)	22,974 (158,400)	C: 968.5 (6,677.6)

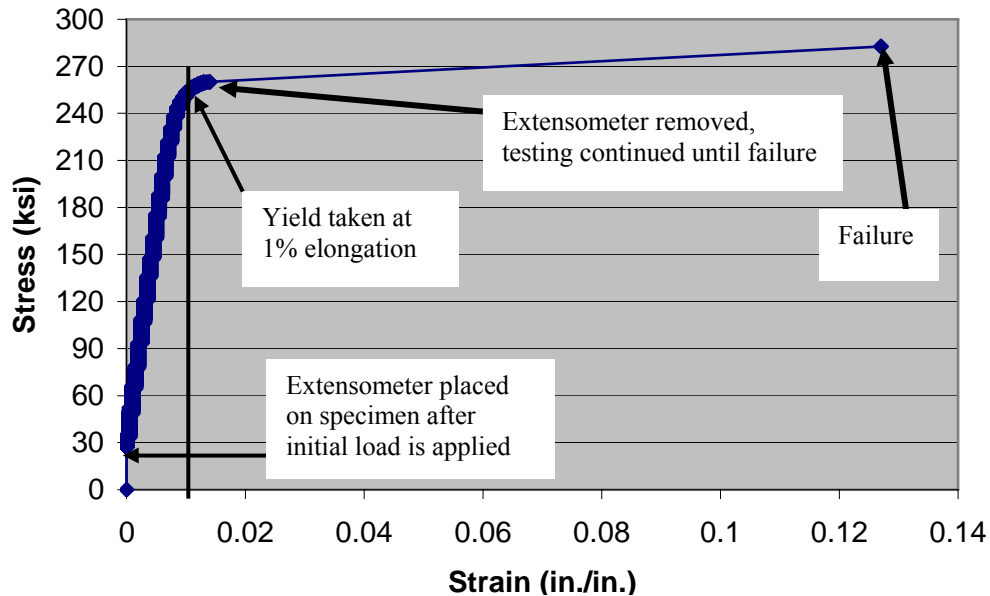
**Table 4.3 Test results Phase II: 0.375 in. strand diameter**

Specimen ID	Yield Stress,	Ultimate Load,	Modulus of	Standard Deviation
	ksi (MPa) A	kips (kN) B	Elasticity, ksi (MPa) C	A: Yield Stress B: Ultimate Load C: Modulus of E.
2-1-4-1-1	178 (1,227)	17.1 (76.1)	26,151 (180,305)	A: 0.95 (6.6)
2-1-4-1-2	180 (1,241)	17.4 (77.4)	26,541 (182,994)	B: 0.15 (0.7)
2-1-4-1-3	179 (1,234)	17.1 (76.1)	26,755 (184,469)	C: 250.1 (1,724.4)
2-1-5-1-1	177 (1,220)	16.0 (71.2)	28,183 (194,315)	A: 1.15 (7.9)
2-1-5-1-2	177 (1,220)	16.0 (71.2)	28,543 (196,797)	B: 0.12 (0.5)
2-1-5-1-3	180 (1,241)	15.7 (69.8)	28,504 (196,528)	C: 161.3 (1,112.1)
2-1-6-1-1	122 (841)	10.4 (46.3)	26,767 (184,552)	A: 0.88 (6.1)
2-1-6-1-2	120 (827)	10.2 (45.4)	28,345 (195,432)	B: 0.07 (0.3)
2-1-6-1-3	121 (834)	10.3 (45.8)	29,577 (203,926)	C: 1,150.1 (7,929.7)

**Table 4.4 Test results Phase II: 0.5 in. strand diameter**

Specimen ID	Yield Stress,	Ultimate Load,	Modulus of	Standard Deviation
	ksi (MPa) A	kips (kN) B	Elasticity, ksi (MPa) C	A: Yield Stress B: Ultimate Load C: Modulus of E.
2-2-4-1-1	182 (1,255)	31.0 (137.9)	28,716 (197,990)	A: 1.08 (7.4)
2-2-4-1-2	185 (1,276)	31.4 (139.7)	31,028 (213,931)	B: 0.17 (0.8)
2-2-4-1-3	183 (1,262)	31.2 (138.8)	29,767 (205,236)	C: 945.2 (6,516.9)
2-2-5-1-1	168 (1,158)	28.5 (126.8)	32,136 (221,570)	A: 1.18 (8.1)
2-2-5-1-2	167 (1,151)	28.6 (127.2)	28,971 (199,748)	B: 0.11 (0.5)
2-2-5-1-3	170 (1,172)	28.8 (128.1)	32,878 (226,686)	C: 1,694.2 (11,681.0)
2-2-6-1-1	123 (848)	18.8 (83.6)	31,007 (213,786)	A: 0.82 (5.7)
2-2-6-1-2	123 (848)	18.9 (84.1)	30,059 (207,250)	B: 0.12 (0.5)
2-2-6-1-3	122 (841)	18.6 (82.7)	31,273 (215,620)	C: 521.03 (3,592.4)

A typical stress-strain plot produced by a tension test is shown in Figure 4.6. As described by the test procedure, the extensometer was attached after the initial load and then removed prior to failure. Yield was measured at 1 percent elongation as specified by ASTM A416M-06. The strain at failure was determined by stroke readings.



Conversion Units:  $1^{\circ}\text{F} = 0.56^{\circ}\text{C}$ ;  $1 \text{ ksi} = 6.9 \text{ MPa}$

**Figure 4.6 Typical stress-strain curve for tension testing**

**4.1.3. Failure Mode.** The failure modes of the strands were directly related to the heat damage experienced in the furnace. As the exposure temperature increased, the failure mode moved closer to the lower grip where the machine was pulling the strand. Due to the irregular shape of prestressing strands this type of failure is considered acceptable by ASTM A370-07a. The standard states in Note A7.3 “Specimens that break outside the extensometer or in the jaws and yet meet the minimum specified values are considered as meeting the mechanical property requirements of the product specification, regardless of what procedure of gripping has been used.”

Specimens exposed to elevated temperatures were not expected to meet mechanical property requirements due to mechanical alterations by heat, however unexposed strands were used to verify acceptance of the testing method. These specimens failed in an acceptable manner stated by ASTM A370-07a by producing a yield greater than 243 ksi (1675 MPa) and a breaking strength greater than 270 ksi (1862 MPa). These specimens also failed in the center between the two jaws. Typical failure modes are shown in Figure 4.7.



**Figure 4.7 Typical failure mode of prestressing strand in tension**

**4.1.4. Discussion of Results.** From the test results several important observations can be made. Tensile strength, modulus of elasticity and yield strength are all specific properties which have been analyzed and reported in this section. Additional analysis and conclusions have been made regarding temperature level, size of strand, cooling method and heat exposure time.

**4.1.4.1 Tensile strength.** The percent of original tensile strength vs. temperature for the specimens of Phase I (heated for 60 minutes) can be seen in Figure 4.8. The tensile strength of the strands decreases only 4 percent for the 0.5 in. strands and 1 percent for the 0.375 in. strands between the temperatures of 68°F (20°C) and 500°F (260°C). A slightly larger weakening occurs between the temperatures of 500°F (260°C) and 800°F (427°C) as there is an 8 percent and 11 percent decrease for the 0.5 in. and 0.375 in. strands, respectively. However, a significant loss in tensile strength occurs after 800°F (427°C). The curve begins a steep downward trend until it reaches 1200°F (649°C) where it starts to level off. For temperatures 800°F (427°C) to 1200°F (649°C) a total loss of 48 percent and 46 percent was experienced by the 0.5 in. and 0.375 in. strands respectively.

Based on Figure 4.8 it appears that the loss of tensile strength is proportional for both strand sizes. There is a small statistical difference between the strands sizes in the percent of ultimate tensile strength at 500°F (260°C), 1000°F (538°C) and 1200°F (649°C). However, there is no indication that the size of the steel has any effect on the residual tensile strength of the steel, because the strand with the highest residual tensile strength varied by temperature. If there was an increase in the specimen pool size it is likely that a statistical difference would not exist.

The previous published data explained in the Section 2.5.1 has been reprinted in Figure 4.9 with the addition of the experimental results from Phase I of this study. The current results are quite similar to that of previous research and can be assumed to be accurate.

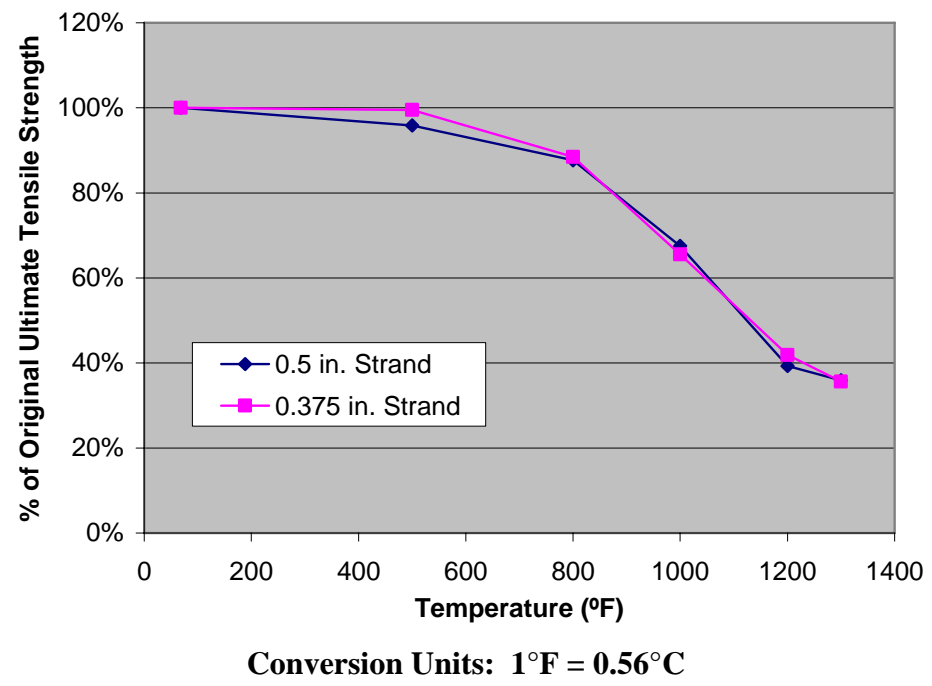


Figure 4.8 Residual ultimate tensile strength vs. temperature

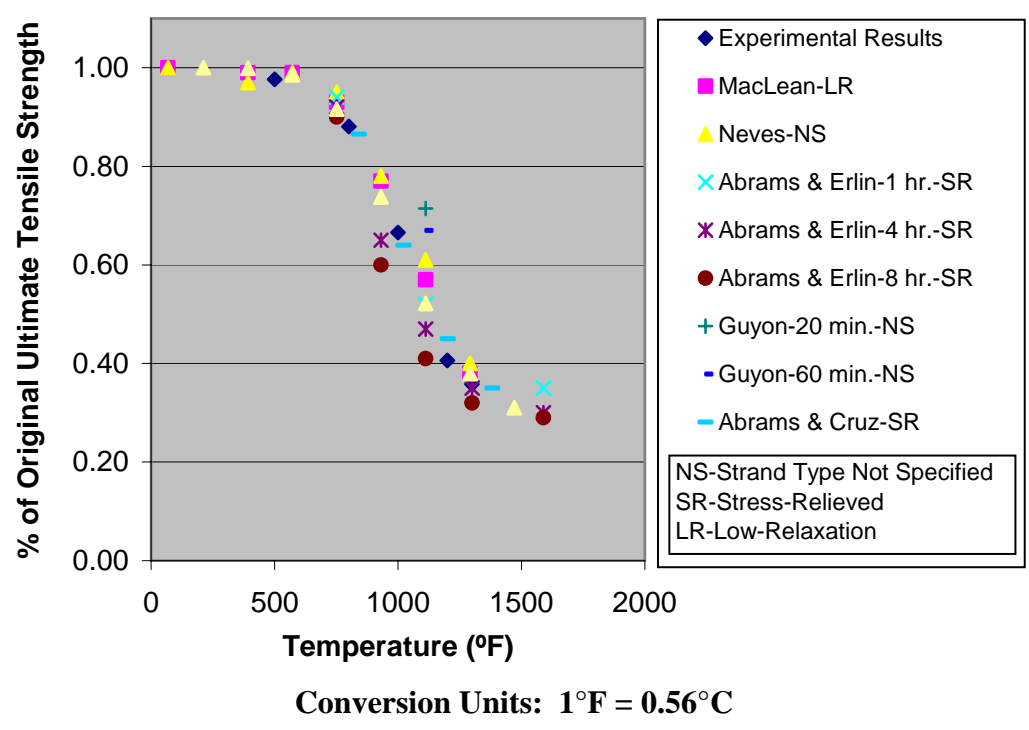
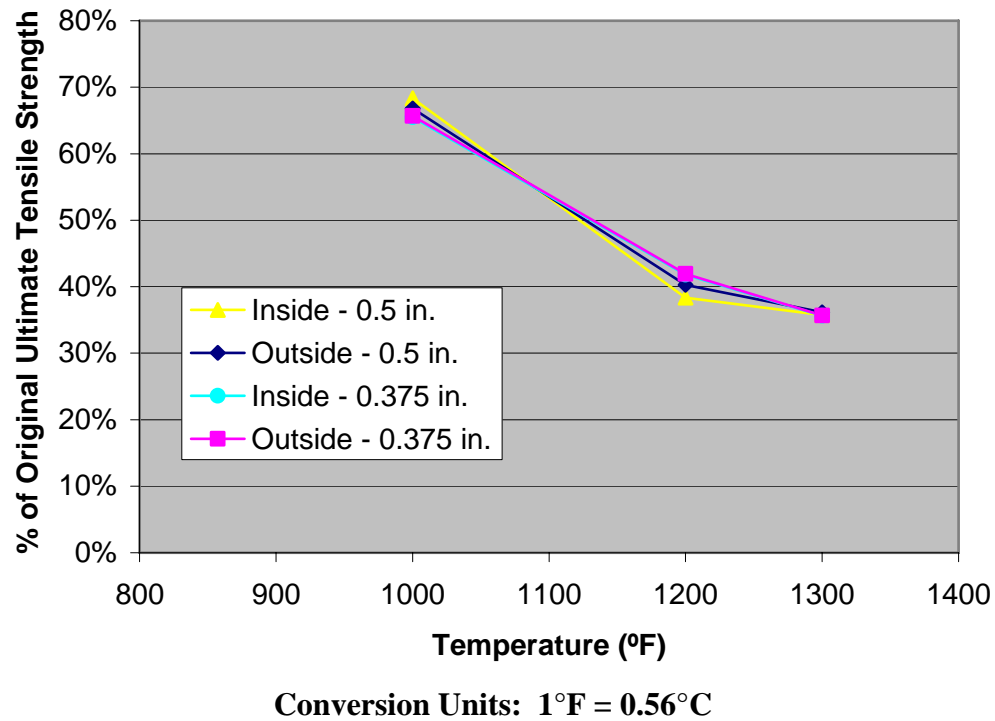


Figure 4.9 Comparison of results with other previous research



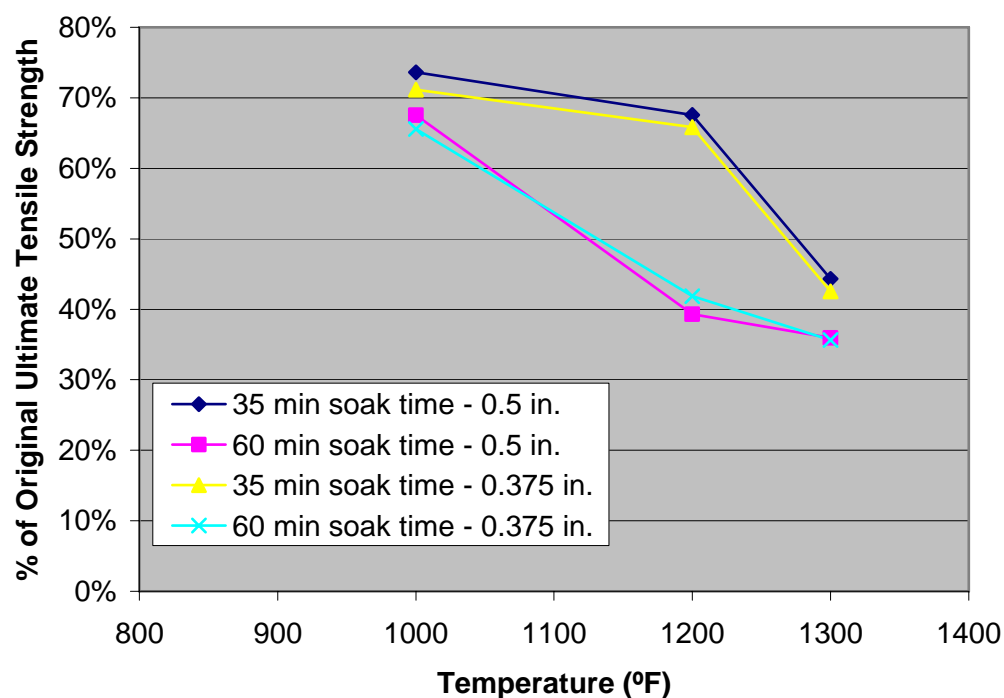
Figure 4.10 compares the ultimate tensile strength of the strands which were left to cool inside the furnace and those which were removed and cooled outside of the furnace. Statistically there is a small difference between strands cooled inside the furnace and strands cooled outside of the furnace. However, it is inconclusive which method produces higher tensile strengths, because for each temperature the cooling method which produced the highest tensile strength varied. For this experimental work, only two (2) specimens were used for the 0.375 in. strands and three (3) specimens for the 0.5 in. strands. If a larger pool of specimens were to be tested, the standard deviation may be lower. If this were to be true, Abrams and Cruz (1961) conclusions discussed in Section 2.5.3 regarding cooling methods could be confirmed.



**Figure 4.10 Comparison of cooling methods**

The length of heat soak time is shown in Figure 4.11. At higher temperatures there is a greater loss in strength for specimens soaked for 60 minutes versus those only soaked for 35 minutes. For temperatures between 1000°F (538°C) and 1300°F (704°C), it appears to be more significant than the lower temperatures. However, there is still a measurable difference in strength loss.

The data obtained for the specimens soaked for 35 minutes is similar to that of Guyon who soaked specimens for 20 minutes. However, Guyon did not report the type of strand tested; therefore no direct correlation can be made. Also, Abrams and Erlin (1967) noted a difference in tensile strength due to the length of time the specimens were soaked. However, their study consisted of longer intervals (1 hour, 4 hours and 8 hours) which resulted in small variances.

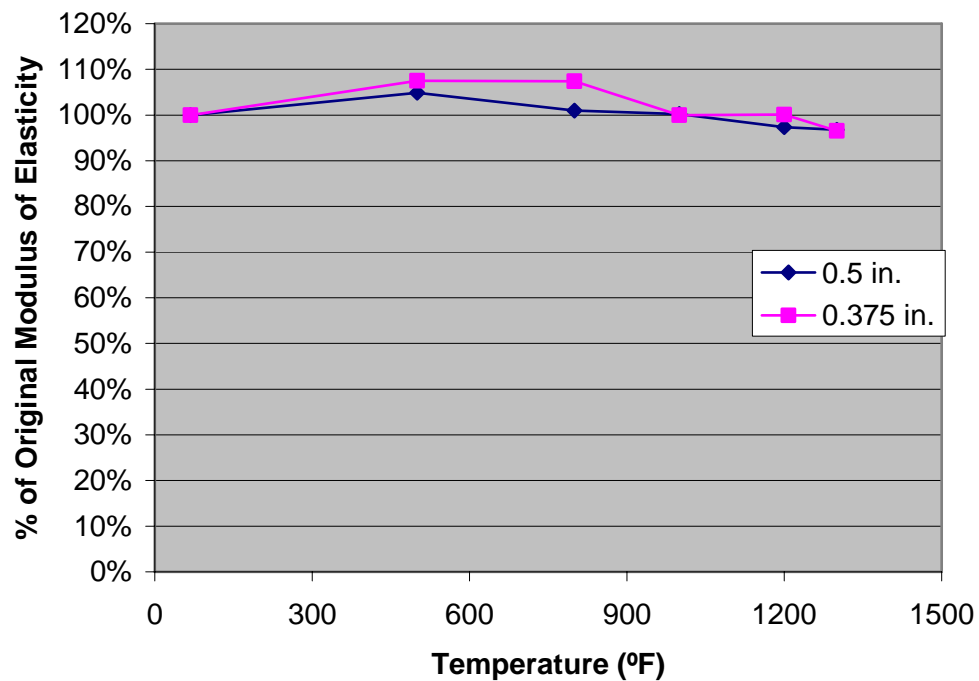


Conversion Units: 1°F = 0.56°C

Figure 4.11 Comparison of heat soak time

**4.1.4.2 Modulus of elasticity.** The modulus of elasticity based on temperature exposure is given in Figure 4.12. The values for this property were determined by measuring the slope of the initial linear section of the plot.

This particular property was found to be fairly constant despite the increase in temperature. The values actually increased for temperatures of 500°F (260°C) and 800°F (427°C). They then decreased for the remaining elevated temperatures, but only to 97 percent of the original modulus value. This compares similarly to Holmes and MacLean. The behavior of the prestressing strand is much like that of mild steel which has also been found to not change after heating and cooling (Edwards, Gamble, 1986).

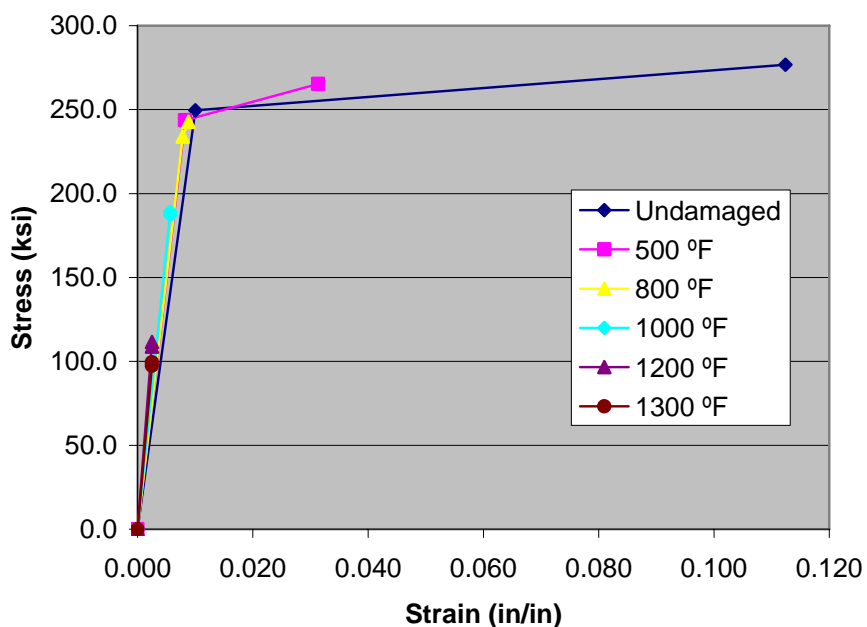


Conversion Units: 1°F = 0.56°C

**Figure 4.12 Residual modulus of elasticity vs. temperature**

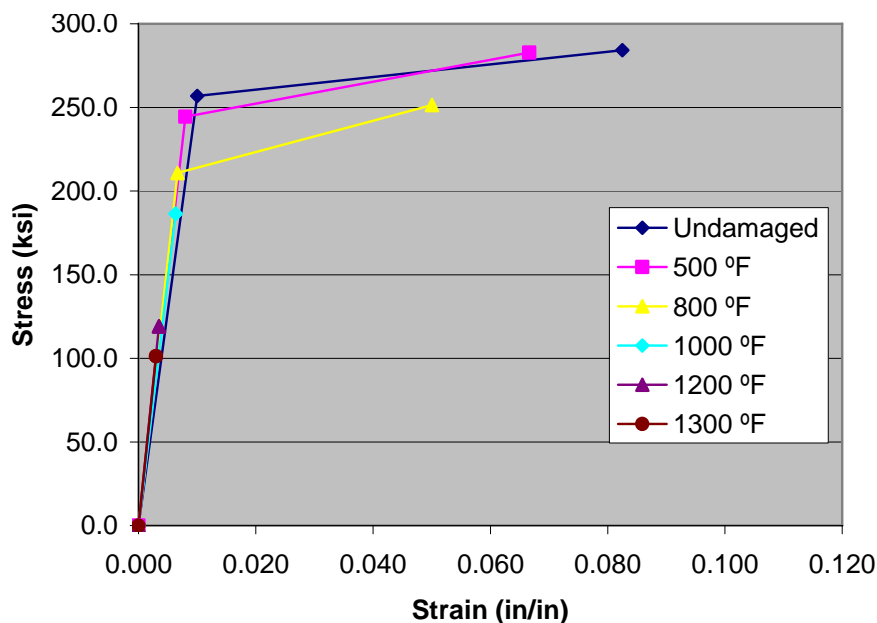
**4.1.4.3 Yield.** As discussed in Section 4.3.2, the yield strength which is defined by ASTM A416M-06 was to be taken at 1 percent elongation. However, for the specimens exposed to elevated temperatures, this elongation was not possible and the yield was taken at the point of significant slope change. Furthermore, for the higher temperatures a slope change was often unrecognizable and the yield was taken as the point of fracture.

In the case of the 0.5 in. strand heated to 800°F (427°C), the fracture occurred immediately after the yield with little tensile strength increase. Strands heated to temperatures above 800°F (427°C) fractured before an indication of yielding occurred. The 800°F (427°C) temperature mark is very close to the limit at which all non-linear behavior is lost. You will note from the stress-strain curves shown in Figures 4.13 and 4.14, that the 0.375 in. strand heated to 800°F (427°C) did exhibit some non-linearity, but at 1000°F (538°C) did not exhibit any. Therefore, the temperatures of 800°F-1000°F (427°C-538°C) are a critical temperature range for the strands in which all non-linear behavior is lost.



Conversion Units: 1 ksi = 6.9 MPa

Figure 4.13 Stress vs. strain for 0.5 in. specimens of Phase I



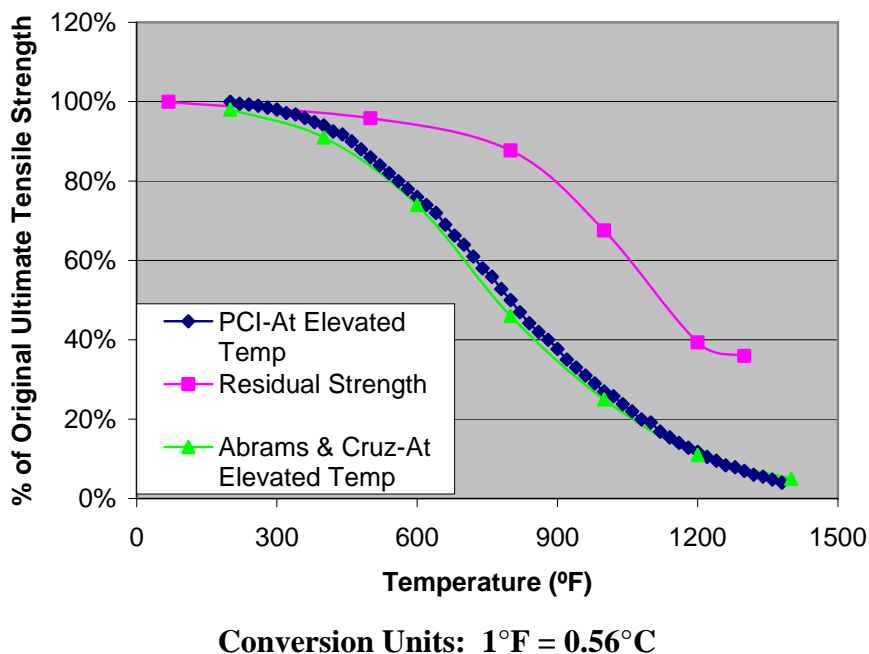
Conversion Units: 1 ksi = 6.9 MPa

Figure 4.14 Stress vs. strain for 0.375 in. specimens of Phase I

The loss of non-linear behavior is directly related to the loss of ductility and prior indication of failure. Strands heated to the 800°F-1000°F (427°C-538°C) temperature range will still maintain over 65 percent of their undamaged tensile strength which in some applications will be sufficient. However, in addition they will also lose almost or all of their non-linear behavior becoming more brittle. Materials which fail without significant warning are normally avoided for use in structural components. Some sign of distress such as significant concrete cracking prior to failure is desirable, which means the loss of ductility in the reinforcing is highly undesirable.

**4.1.4.4 Tensile strength at elevated temperatures.** Another topic of interest is how the residual tensile strength of the strands compare with the tensile strength of the strands at elevated temperatures. In Figure 4.15, the experimental results from this study are compared with the tensile strength of prestressing strands at elevated temperatures reported by other researchers (PCI Design Handbook, 2004; Abrams and Cruz, 1961). It can be noted that there is a significant increase in tensile strength upon cooling for all

temperatures greater than 400°F (204°C). This observation was also reported by Abrams and Erlin (1967).



**Figure 4.15 Comparison of tensile strength for prestressing strands at elevated temperatures and residual tensile strength of prestressing strands**

## 4.2. PULLOUT TESTS

**4.2.1. Visual Observations.** After the concrete blocks were heated, visual observations were taken. For the 11 ksi concrete hairline cracking first occurred at 800°F (427°C). As the temperature increased, the cracks grew in size and in concentration. For the 14 ksi concrete, only one block out of the five heated to 800°F (427°C) had any observable cracks. For the block that exhibited cracking, the hairline cracking was

minimal. With increasing temperature, both concrete compressive strengths behaved similarly with an increasing number of cracks and crack size. Initial hairline cracking for both compressive strengths can be seen in Figure 4.16.



**Figure 4.16 Initial hairline cracking noted for each compressive strength (left: 11 ksi, right: 14 ksi)**

The observations regarding the occurrence of cracking and crack density are consistent with research reported by Guise et al. (1996) for concrete strengths of 8.3 ksi (56.9 MPa), 6.7 ksi (46.4 MPa) and 6.3 ksi (43.6 MPa). The experimental work for this study contributes new data to the research reported by Guise et al. Information obtained regarding concrete compressive strengths of 11 ksi and 14 ksi confirm conclusions by Guise et al. regarding the crack density behavior based on compressive strength, but for higher strengths than previously studied.

Some spalling was noticed during the heating process. In most cases the spalling was local with a few popouts occurring as shown in Figure 4.17 on the left. However, in one case a high compressive strength block heated to 1300°F (704°C) experienced spalling which fell between the categories of serious sloughing and explosive spalling. The physical damage is shown in Figure 4.16 on the right. This block was replaced by a new block for testing purposes.

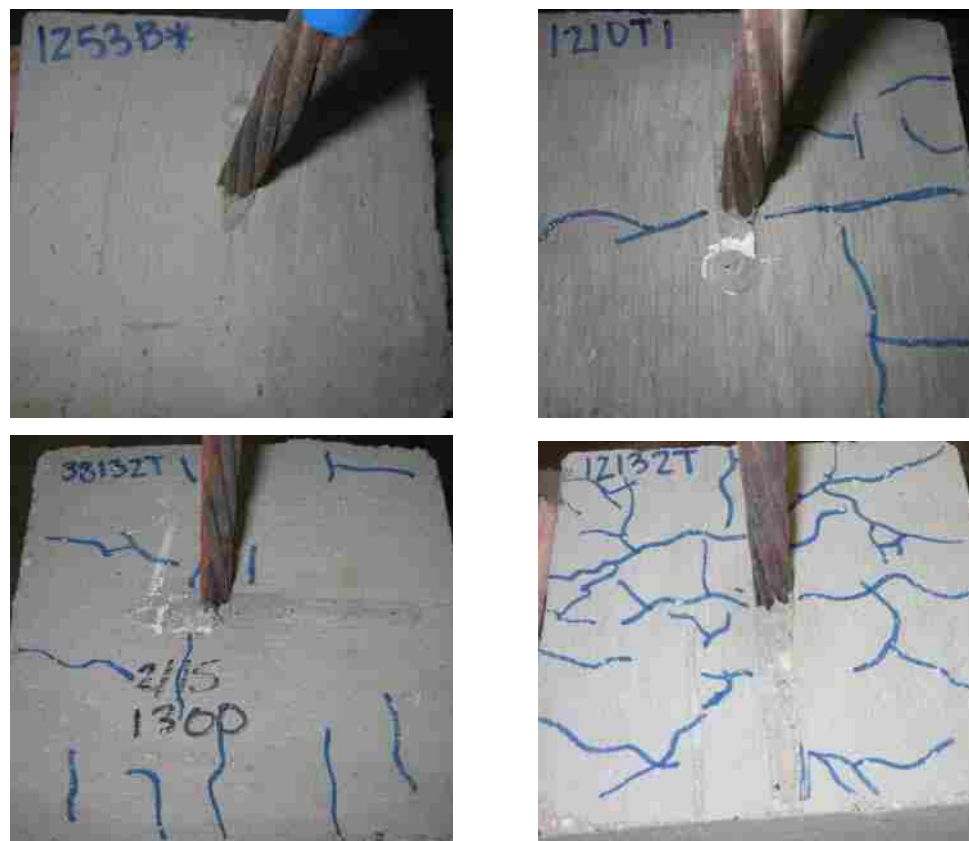


**Figure 4.17 Examples of spalling noted after heating process (left: local spalling, right: serious sloughing/explosive spalling)**

Although the density of cracking and spalling increased with temperature, the amount of damage varied by temperature and for specimens within each temperature. For a particular temperature, one specimen would show very little cracking while a companion specimen had significant cracking. For this reason as well as to better understand the physical changes that affect the bond behavior, the specimens were ranked into four different cracking categories.

The first category titled “Undamaged” are blocks with zero to 4 cracks. The second ranking, “Mild” describes specimens which had a few cracks, typically around 10-20 percent on the top or bottom surface of the block. “Moderate” damage was considered to be specimens which had 20-40 percent cracking on the top or bottom surface, and “Severe” were specimens with more than 40 percent cracking and local spalling. The various categorized levels of damage can be seen visually in Figure 4.18.





**Figure 4.18 Classification of heat induced cracking (top left: Undamaged, top right: Mild, bottom left: Moderate, bottom right: Severe)**

After heating color change was not initially recognizable for any of the concrete blocks because the main indicator, the aggregate, was not exposed. However, the aggregate of the block that underwent severe spalling was exposed after the incident and a slight pink discoloration was noted. Also during testing, color was visible after the failure of each specimen.

**4.2.2. Test Results.** For this type of bond testing, the critical property investigated is the bond stress,  $u$ . This value is calculated using Equation 4.1 where  $P$  is the maximum load,  $p_{ps}$  is the perimeter of the strand and  $L$  is the embedment length of the strand.

$$u = \frac{P}{p_{ps}L}$$

Equation 4.1

The results from the pullout testing for the 11 ksi specimens are presented in Tables 4.5 and 4.6. For each specimen, the bond stress and crack rating determined prior to testing is reported. In addition, the average bond stress and standard deviation (abbreviated STD Dev) for each set of replicates is also given.

**Table 4.5 Test results 11 ksi: 0.5 in. strand diameter**

Specimen	Crack Rating	Bond Stress, psi (MPa)	Statistical Analysis psi (MPa)
11-2-1-1	Undamaged	846.0 (5.83)	Average: 826.0 (5.70) STD Dev: 33.1 (0.29)
11-2-1-2	Undamaged	780.4 (5.38)	
11-2-1-3	Undamaged	854.4 (5.89)	
11-2-2-1	Undamaged	607.1 (4.19)	Average: 654.9 (4.52) STD Dev: 37.0 (0.26)
11-2-2-2	Undamaged	697.2 (4.81)	
11-2-2-3	Undamaged	660.3 (4.55)	
11-2-3-1	Undamaged	424.6 (2.93)	Average: 318.8 (2.20) STD Dev: 75.5 (0.52)
11-2-3-2	Mild	253.7 (1.75)	
11-2-3-3	Mild	278.1 (1.92)	
11-2-4-1	Mild	121.7 (0.84)	Average: 158.9 (1.10) STD Dev: 35.2 (0.24)
11-2-4-2	Mild	206.1 (1.42)	
11-2-4-3	Mild	148.9 (1.03)	
11-2-5-1	Severe	128.1 (0.88)	Average: 151.6 (1.05) STD Dev: 17.1 (0.12)
11-2-5-2	Mild	168.5 (1.16)	
11-2-5-3	Moderate	158.1 (1.09)	
11-2-6-1	Moderate	190.9 (1.32)	Average: 154.9 (1.07) STD Dev: 45.7 (0.32)
11-2-6-2	Severe	90.4 (0.62)	
11-2-6-3	Moderate	183.3 (1.26)	

**Table 4.6 Test results 11 ksi: 0.375 in. strand diameter**

Specimen	Crack Rating	Bond Stress, psi (MPa)	Statistical Analysis psi (MPa)
11-1-1-1	Undamaged	1,074.2 (7.41)	Average: 1,026.7 (7.08) STD Dev: 37.2 (0.26)
11-1-1-2	Undamaged	983.5 (6.78)	
11-1-1-3	Undamaged	1,022.4 (7.05)	
11-1-2-1	Undamaged	939.2 (6.48)	Average: 898.4 (6.2) STD Dev: 35.2 (0.24)
11-1-2-2	Undamaged	853.3 (5.88)	
11-1-2-3	Undamaged	902.9 (6.23)	
11-1-3-1	Undamaged	619.5 (4.27)	Average: 627.0 (4.3) STD Dev: 99.0 (0.68)
11-1-3-2	Undamaged	751.9 (5.18)	
11-1-3-3	Mild	509.6 (3.51)	
11-1-4-1	Mild	219.3 (1.51)	Average: 218.3 (1.5) STD Dev: 11.3 (0.08)
11-1-4-2	Mild	231.6 (1.60)	
11-1-4-3	Moderate	203.8 (1.41)	
11-1-5-1	Undamaged	272.7 (1.88)	Average: 216.3 (1.5) STD Dev: 65.5 (0.45)
11-1-5-2	Undamaged	250.3 (1.73)	
11-1-5-3	Mild	125.9 (0.87)	
11-1-6-1	Mild	232.1 (1.60)	Average: 199.6 (1.4) STD Dev: 31.8 (0.22)
11-1-6-2	Moderate	210.2 (1.45)	
11-1-6-3	Severe	156.4 (1.08)	

Shown in Tables 4.7 and 4.8 are the results for the 14 ksi specimens. As with the 11 ksi specimens, the bond stress and crack rating determined prior to testing is reported for each specimen and a statistical analysis was performed for each set of replicates.

**Table 4.7 Test results 14 ksi: 0.5 in. strand diameter**

Specimen	Crack Rating	Bond Stress, psi (MPa)	Statistical Analysis psi (MPa)
14-2-1-1	Undamaged	1,084.6 (7.48)	Average: 1,099.5 (7.58) STD Dev: 53.7 (0.37)
14-2-1-2	Undamaged	1,171.4 (8.08)	
14-2-1-3	Undamaged	1,042.5 (7.19)	
14-2-2-1	Undamaged	918.9 (6.33)	Average: 990.7 (6.83) STD Dev: 53.1 (0.37)
14-2-2-2	Undamaged	1,007.3 (6.95)	
14-2-2-3	Undamaged	1,045.8 (7.21)	
14-2-3-1	Undamaged	906.1 (6.25)	Average: 849.1 (5.85) STD Dev: 56.8 (0.39)
14-2-3-2	Undamaged	771.6 (5.32)	
14-2-3-3	Mild	869.7 (6.00)	
14-2-4-1	Mild	449.8 (3.10)	Average: 357.8 (2.47) STD Dev: 66.1 (0.46)
14-2-4-2	Moderate	297.8 (2.05)	
14-2-4-3	Mild	325.8 (2.25)	
14-2-5-1	Mild	274.1 (1.89)	Average: 273.1 (1.88) STD Dev: 20.6 (0.14)
14-2-5-2	Moderate	247.3 (1.71)	
14-2-5-3	Mild	297.8 (2.05)	
14-2-6-1	Moderate	219.7 (1.51)	Average: 225.6 (1.56) STD Dev: 11.3 (0.08)
14-2-6-2	Moderate	241.3 (1.66)	
14-2-6-3	Moderate	215.7 (1.49)	

**Table 4.8 Test results 14 ksi: 0.375 in. strand diameter**

Specimen	Crack Rating	Bond Stress, psi (MPa)	Statistical Analysis psi (MPa)
14-1-1-1	Undamaged	1,307.3 (9.01)	Average: 1,273.2 (8.78)
14-1-1-2	Undamaged	1,239.0 (8.54)	STD Dev: 34.2 (0.24)
14-1-2-1	Undamaged	1,095.0 (7.55)	Average: 1,127.0 (7.77)
14-1-2-2	Undamaged	1,159.0 (7.99)	STD Dev: 32.0 (0.22)
14-1-3-1	Undamaged	1,043.8 (7.20)	Average: 1,017.1 (7.01)
14-1-3-2	Undamaged	990.4 (6.83)	STD Dev: 26.7 (0.18)
14-1-4-1	Mild	528.3 (3.28)	Average: 502.1 (3.46)
14-1-4-2	Mild	476.0 (3.28)	STD Dev: 26.2 (0.18)
14-1-5-1	Moderate	350.0 (2.41)	Average: 405.0 (2.79)
14-1-5-2	Mild	460.0 (3.17)	STD Dev: 55.0 (0.38)
14-1-6-1	Moderate	183.6 (1.27)	Average: 219.1 (1.51)
14-1-6-2	Mild	254.5 (1.75)	STD Dev: 35.5 (0.24)

**4.2.3. Failure Mode.** For the majority of the 0.5 in. undamaged and 500°F (260°C) 14 ksi specimens the failure was brittle upon initial slip. The load would increase rapidly up to the point of failure where the strand would then slip and the block would fracture into several pieces. This behavior can be seen graphically in Figure 4.19. In contrast, the majority of the 0.375 in. specimens which were undamaged and heated to 500°F (260°C) did not ever fracture and failure was taken at a slip of 3 in. (76.2 mm). This behavior is shown graphically in Figure 4.20.

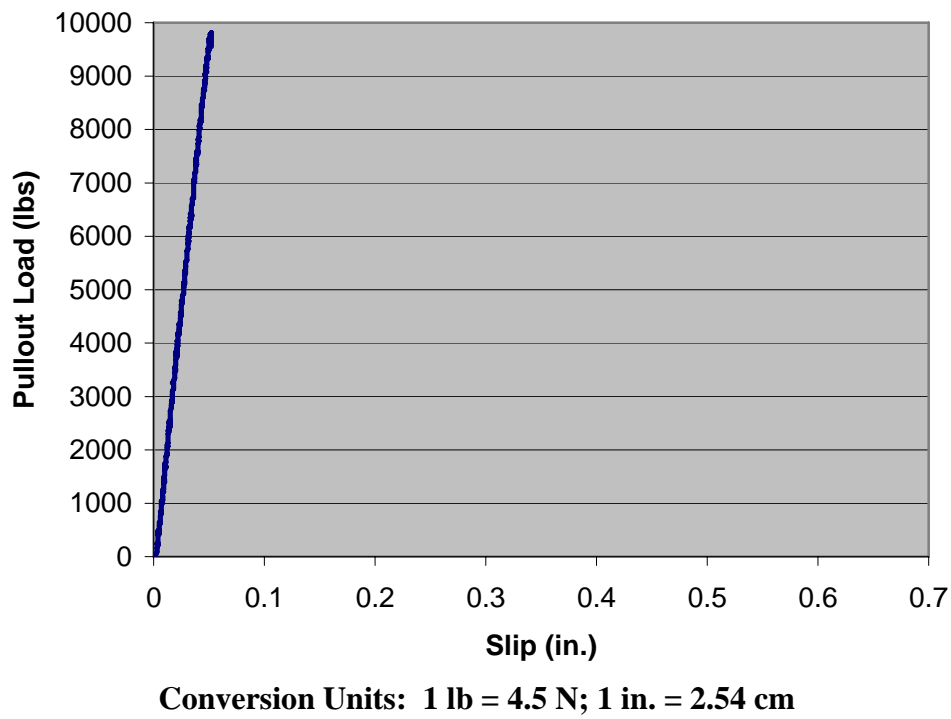


Figure 4.19 Pullout load vs. slip for a typical brittle failure (Specimen 14-2-1-2)

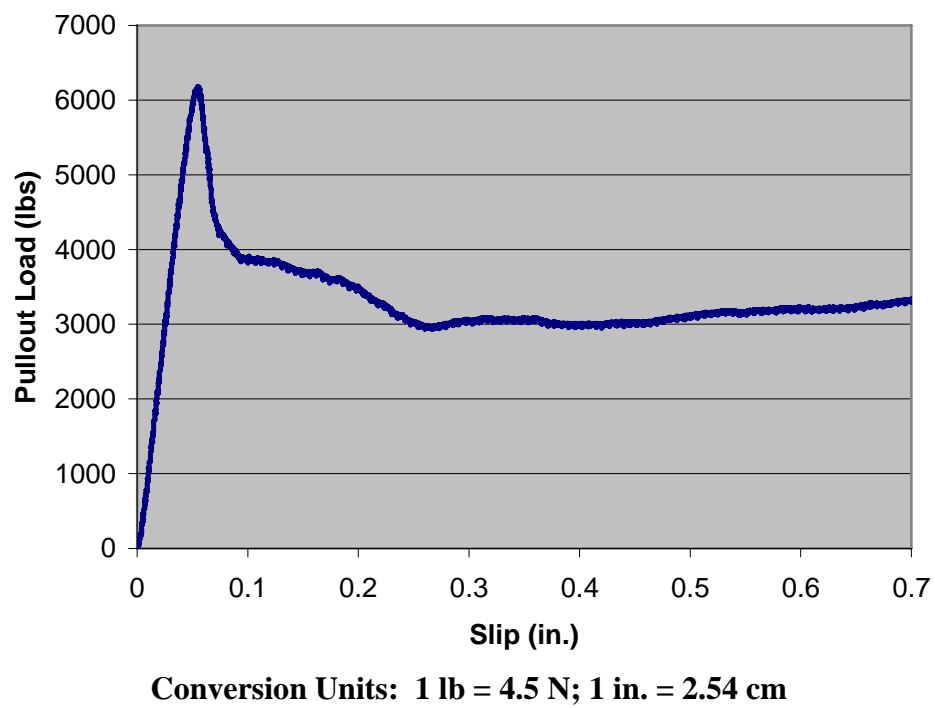


Figure 4.20 Pullout load vs. slip for a typical ductile failure (Specimen 11-1-1-2)

As the temperature decreased for the 14 ksi specimens, the 0.5 in. failure became ductile and the 0.375 in. specimens began to fail at similar levels and slip. After the initial slip, the bond remained and continued to take on load for a period of time before the block fractured. In cases where a specimen had a higher cracking rating than its companion specimens, failure occurred sooner and usually at a lower bond strength.

All of the 11 ksi specimens produced a ductile failure, despite the level of temperature exposure. Similarly to the 14 ksi blocks, several of the 0.375 in. control and 500°F (260°C) specimens never fractured and failure was taken at a slip of 3 in. (76.2 mm). However, for the 0.5 in. control and 500°F (260°C) specimens fracture occurred after significant slip. This failure also occurred for the remainder of all of the specimens and was similar to that of the 14 ksi blocks.

Figure 4.21 shows examples of the three different types of failure modes observed during testing. The lighter cracking lines shown in 4.21B indicate heat induced cracking. The darker defined lines indicate cracking which occurred at failure.



A. left: brittle failure, right: failure taken at 3 in. (76.2 mm) slip

Figure 4.21 Typical failure modes for pullout testing



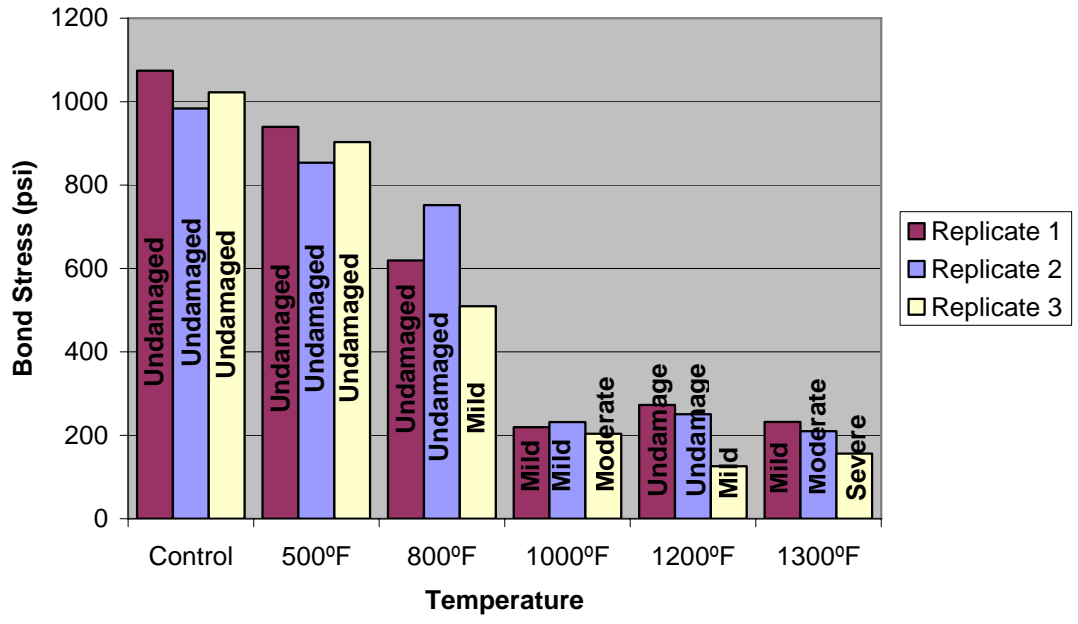
**B. left: ductile failure, right: ductile failure**

**Figure 4.21 Typical failure modes for pullout testing (cont.)**

These modes of behavior are likely based on several factors. One cause may be the compressive strength of the concrete. As the strength of the concrete increases the ductility decreases. We see this in the behavior of the 14 ksi specimens which were undamaged or exposed to 500°F (260°C). These specimens exhibited a highly brittle failure. However, with the increase in heat exposure the compressive strength dropped (as explained in Section 2.5) and the failure became more ductile. Likewise, the 11-ksi specimens produced ductile failures throughout.

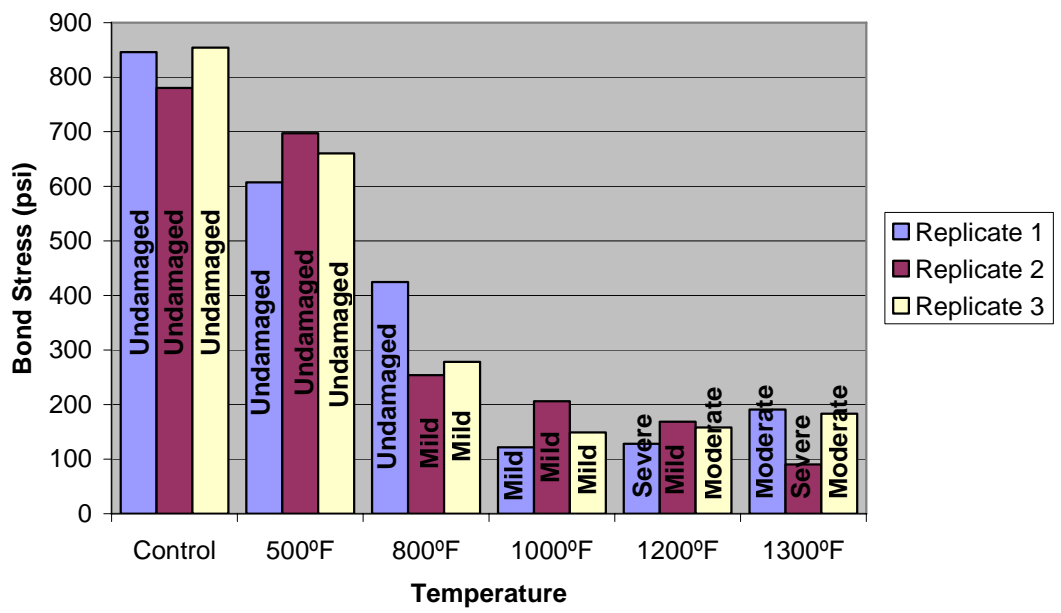
Another possible factor contributing to the failure mode behavior is the crack rating. Figures 4.22-4.25 compare the crack rating and bond stress for specimens of the same type. When comparing the replicates of the same type head to head, it can be seen that the majority of the specimen's performance was based on their crack rating. Further research where the crack density is more accurately quantified may lead to further understanding of how the crack density affects the bond stress performance. As previously mentioned, an analysis regarding the microstructure of the concrete after heating is also necessary to develop further conclusions regarding this relationship.





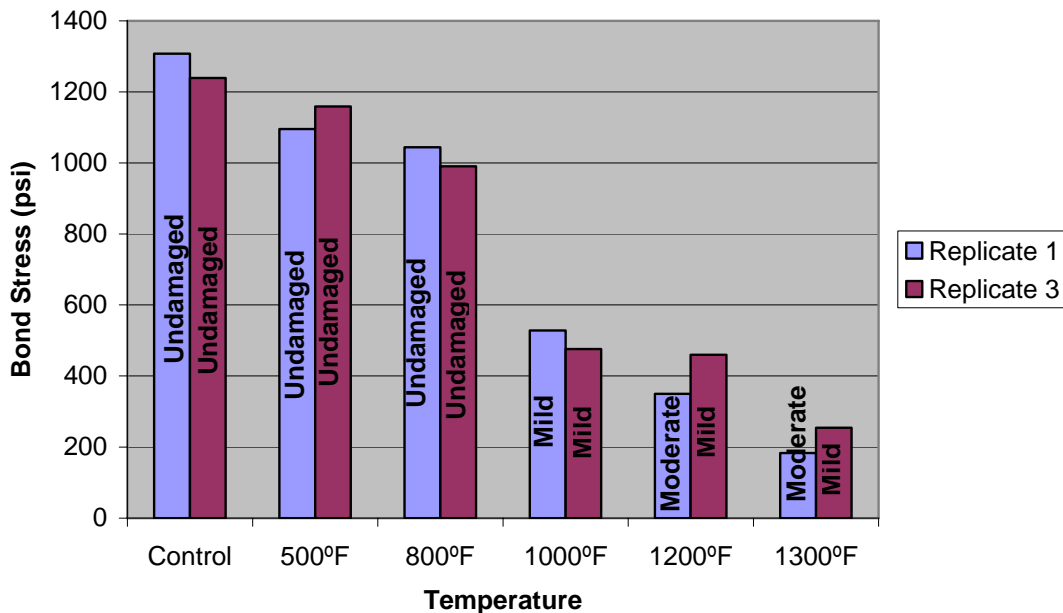
Conversion Units: 1 psi = 6.9 kPa; 1 in. = 2.54 cm

Figure 4.22 Comparison of bond stress vs. crack density for each specimen type of 11 ksi, 0.375 in. strands



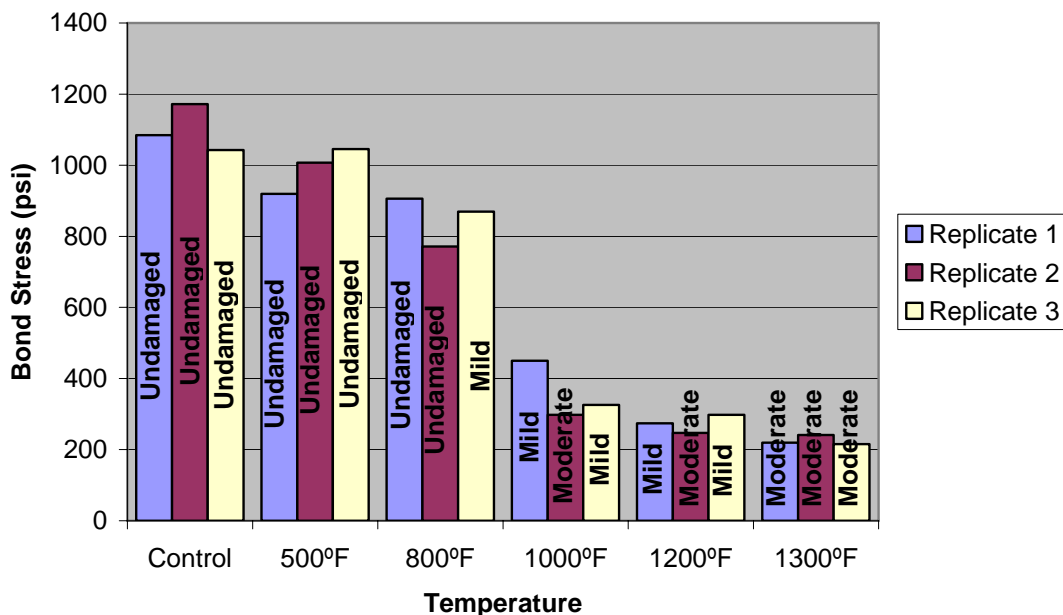
Conversion Units: 1 psi = 6.9 kPa; 1 in. = 2.54 cm

Figure 4.23 Comparison of bond stress vs. crack density for each specimen type of 11 ksi, 0.5 in. strands



Conversion Units: 1 psi = 6.9 kPa; 1 in. = 2.54 cm

Figure 4.24 Comparison of bond stress vs. crack density for each specimen type of 14 ksi, 0.375 in. strands



Conversion Units: 1 psi = 6.9 kPa; 1 in. = 2.54 cm

Figure 4.25 Comparison of bond stress vs. crack density for each specimen type of 14 ksi, 0.5 in. strands

**4.2.4. Discussion of Results.** Unlike the tension testing portion of the research study there are a limited number of ways to report the pullout testing data. For this phase of work only the average bond stress can be calculated. However, with this information code verification and an understanding of bond capacity can be obtained.

**4.2.4.1 Bond capacity.** As discussed earlier in Section 2.4.3, requirements have been established by ACI, AASHTO and FHWA for the expected development length of a prestressing strand. The flexural bond length within these equations can be related to pullout testing by converting the length to a stress. Using Equation 2.1, the average flexural bond stress can be determined for each code and compared to the experimental average bond stresses given in Section 4.2.2. The average bond stress limit specified by ACI/AASHTO and the FHWA are given in Equations 4.2 and 4.3 respectively. In order to calculate the bond stress limits, the effective stress in the steel was assumed to be 151 ksi (1041 MPa) which includes a 75 percent jacking stress and 20 percent total loss at service. The ultimate stress was taken as the average undamaged values (control specimens) measured during the tension testing of the experimental program. For 0.5 in. and 0.375 strands the ultimate stress was 284 ksi (1958 MPa) and 277 ksi (1910 MPa), respectively.

$$u = \frac{(f_{ps} - f_{se})A_{ps}}{(f_{ps} - f_{se})d} \quad \text{Equation 4.2}$$

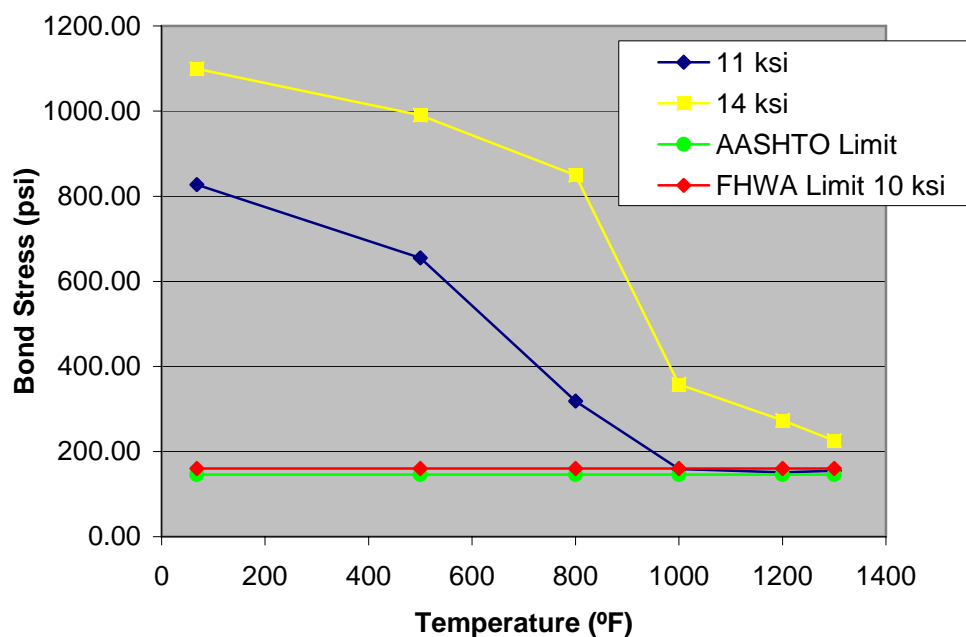
$$u = \frac{(f_{ps} - f_{se})A_{ps}}{p_{ps} \left( \frac{6.4(f_{ps} - f_{se})d}{f'_c} + 15 \right)} \quad \text{Equation 4.3}$$

Table 4.9 provides values for these limits based on 0.5 in. and 0.375 in. prestressing strands. As noted earlier, the FHWA recommends using 10 ksi (68.9 MPa) for concrete compressive strengths over 10 ksi (68.9 MPa) due to lack of establish data.

**Table 4.9 Average bond stress specification limits**

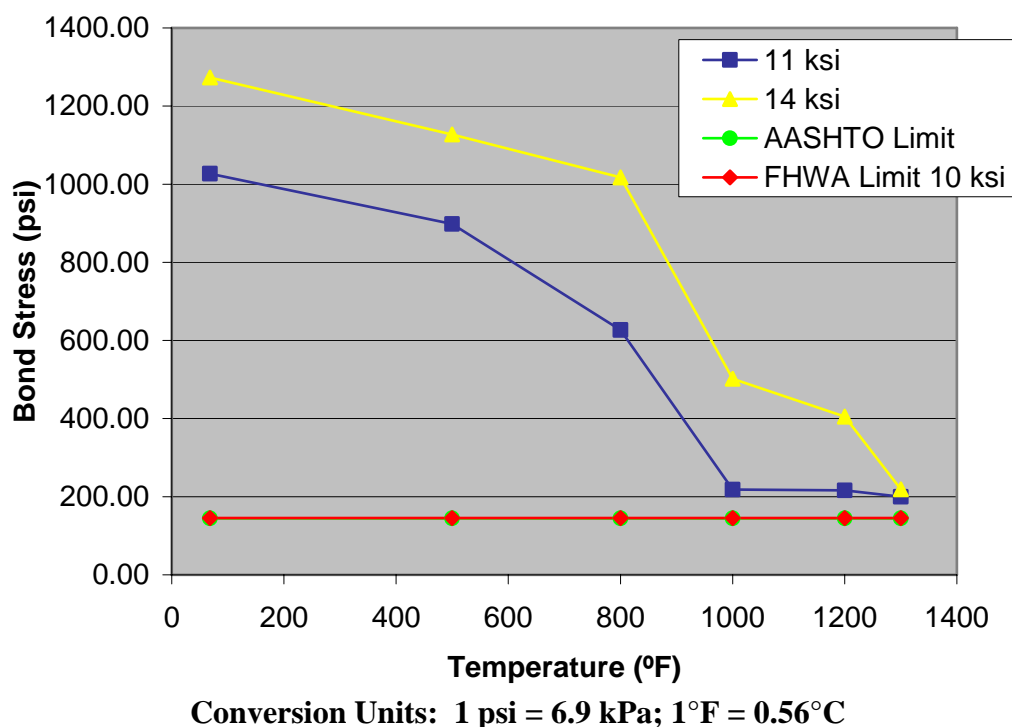
	ACI/AASHTO psi (kPa)	FHWA psi (kPa)
<b>0.5 in.</b>	146.1 (1007)	160.4 (1106)
<b>0.375 in.</b>	144.3 (995)	145.4 (1002)

The average bond stress vs. temperature for each strand diameter is plotted in Figures 4.26 and 4.27. In addition, the specification limits are plotted in the same figure. It is difficult to see from the graph, but the only strand which does not meet the code requirements is the 0.5 in.-11 ksi strand heated to temperatures 1000°F-1300°F (538°C-704°C). The bond stress fails the limits set by FHWA. With the exception of that strand-concrete bond, the remaining specimens were above the specification despite temperature exposure.



Conversion Units: 1 psi = 6.9 kPa; 1°F = 0.56°C

**Figure 4.26 Average bond stress vs. temperature for 0.5 in. prestressing strands**

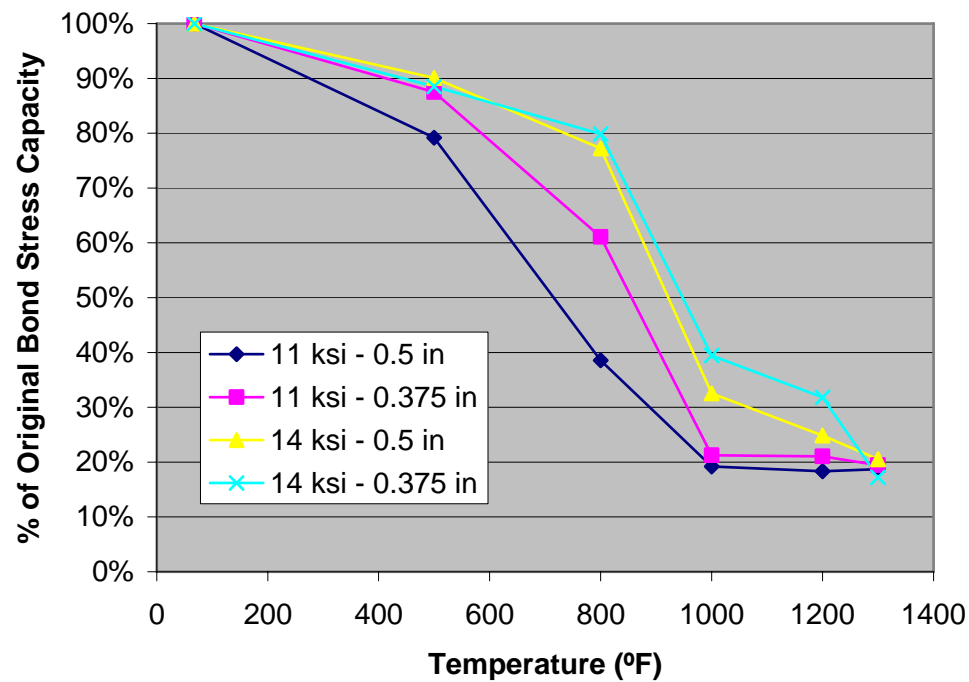


**Figure 4.27 Average bond stress vs. temperature for 0.375 in. prestressing strands**

Figure 4.28 compares the percent of original bond stress capacity vs. temperature for the four different specimen types. The stress for each type varies slightly, but the trend is quite similar for all four. The specimens with a compressive strength of 11 ksi appear to be the weakest in overall bond stress. For each compressive strength, the 0.375 in. specimens have a higher bond stress capacity than that of the 0.5 in. specimens of the same concrete which is consistent with previous work by Hanson and Karr (1959), Lane (1992) and Martin and Scott (1976).

Despite similar testing methods, the experimental values for bond stress are larger than that obtained by Chao. However, the pullout curves are similar in shape. Variations in bond stress capacity may be due to a number of details. One difference in testing may exist in the location of the compressive force while testing. Bond stresses will be significantly lower when splitting is not prevented (Ferguson et al. 1954). Chao also did

not indicate at which time the compressive strength of the concrete was determined. If it was not determined at the time of testing, the results may also vary significantly.



Conversion Units:  $1^{\circ}\text{F} = 0.56^{\circ}\text{C}$

**Figure 4.28** Percent of original bond stress capacity vs. temperature

**4.2.4.2 Implications caused by loss in bond stress.** The decrease in bond stress can prove to be significant to the structural capacity of a member. As the bond stress decreases the required length needed to develop a strand increases. Therefore, the required capacity may not be met along the entire length of the girder. As shown in Figure 4.29 for undamaged girder the strands are designed to develop close to the ends in order to provide adequate flexural section capacity. However, for a damaged member the required moment section capacity remains the same, but the development length

increases. If the length increases too much, there will be areas along the beam in which the strand is unable to carry the required capacity.



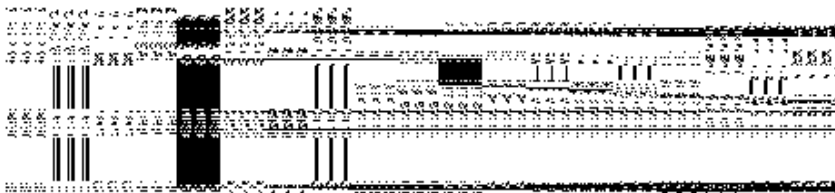
**Figure 4.29 Development length and required flexural section capacity for an undamaged and fire damaged girder**

## 5. PARAMETRIC STUDY

### 5.1. DESIGN EXAMPLE

The design example chosen for the parametric study is from Section 9.6 of the PCI Bridge Design Manual (1997). This particular example is the design of an interior AASHTO-PCI bulb-tee (BT-72) based on LFRD Bridge Design Specifications (1<sup>st</sup> Edition, 1994, and 1996 Interim). The bridge consists of three (3) spans with four (4) girders spaced 12 ft (3.7 m) on center. The 8 in. (203.2 mm) deck is designed to be composite for live load and includes a 0.5 in. (12.7 mm) wearing surface.

Reinforcement includes prestressing strands (located in girder) and mild steel reinforcement (located in deck). Longitudinal and cross-sectional views of the overall bridge and a cross-sectional view of the girder can be seen in Figures 5.1, 5.2 and 5.3. For this PCI bridge design example, two prestressing strand reinforcement details are discussed and analyzed. One design consists of only 0.5 in. strands and will throughout be referred to as the 0.5 in. design. The second design consists of only 0.375 in. strands and will throughout be referred to as the 0.375 design. The use of these two reinforcement designs gives a wider understanding of the effects of fire damage to prestressed concrete bridges. Reinforcement details and strand patterns will be further discussed within the section.



**Conversion Units: 1 in. = 25.4 mm; 1 ft = 0.3 m**

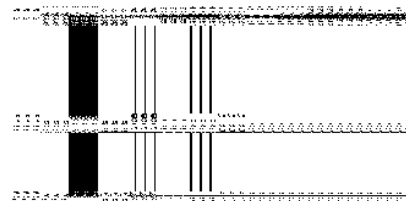
**Figure 5.1 Design example bridge cross-section**





**Conversion Units: 1 in. = 25.4 mm; 1 ft = 0.3 m**

**Figure 5.2 Design example bridge longitudinal section**



**Conversion Units: 1 in. = 25.4 mm; 1 ft = 0.3 m**

**Figure 5.3 Design example composite girder cross-section**

**5.1.1. Design Properties.** Table 5.1 summarizes the assumed undamaged properties of the materials. The values for concrete and mild steel reinforcement were utilized from the design example. The properties for the prestressing strands were taken directly from the strands tested in the laboratory.

**Table 5.1 Assumed undamaged material properties**

<b>Concrete Properties</b>			
	<b>f'c, psi (MPa)</b>		<b>E<sub>c</sub>, ksi (GPa)</b>
<b>Cast-in-place slab</b>	At 28 days: 4,000 (27.6)		At 28 days: 3,384 (23.3)
<b>Precast girders</b>	At release: 5,500 (37.9)		At release: 4,496 (31.0)
	At 28 days: 7,000 (48.3)		At 28 days: 5,072 (35.0)
<b>Mild Steel Reinforcement Properties</b>			
	<b>f<sub>y</sub>, psi (MPa)</b>		<b>E<sub>s</sub>, ksi (GPa)</b>
<b>Reinforcing Bars</b>	60,000 (413.7)		29,000 (199.9)
<b>Prestressing Strand Properties (7-wire, low-relaxation)</b>			
	<b>f<sub>pu</sub>, ksi (MPa)</b>	<b>f<sub>py</sub>, ksi (MPa)</b>	<b>E<sub>ps</sub>, ksi (GPa)</b>
<b>0.5 in. Strands</b>	276.8 (1908.5)	249.6 (1720.9)	25,982 (179.1)
<b>0.375 in. Strands</b>	284.2 (1959.9)	256.8 (1770.6)	25,898 (178.6)

**5.1.2. Load Factors.** Ultimate and nominal moment capacities were calculated using appropriate load resistance factors. Per LRFD 3.4.1 the ultimate bending moment was calculated using Equation 5.1. The resistance factor,  $\phi$ , was taken as 1.00 as specified by LRFD Art. 5.5.4.2. (LRFD Bridge Design Specifications, 1998)

$$M_u = 1.25DC + 1.5DW + 1.75(LL + IM) \quad \text{Equation 5.1}$$

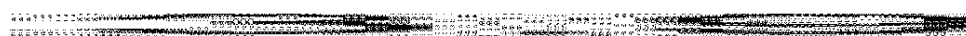
In addition to load factors, reference within the parametric study is often made regarding the Required Actual Capacity. This term represents the load that is expected to be felt by

the bridge and mathematically is the moment caused by the unfactored loads. This value is highly unconservative but is given as a point of reference throughout the analysis to provide some sense of bridge component of member failure.

**5.1.3. Loads.** The self-weight reported in the analysis includes the weight of the girder, deck plus haunch, barrier, and future wearing surface. The live load was an HL-93 in accordance to the LRFD 3.6.1.2. This load consisted of a design truck with two 32 kip (143.3 kN) axle loads 14 ft to 30 ft (4.3 m to 9.1 m) apart and a front axle load of 8 kips (35.6 kN). In addition, a lane load of 0.64 kips/ft (9.34 kN/m) was included. The design truck load also contained a special dynamic allowance for fatigue. Live load deflection was calculated using the 0.8 truck plus lane load and the maximum moment caused by the live load determined during analysis.

**5.1.4. Reinforcement Details.** As previously explained two types of reinforcing were provided in the design. The mild steel reinforcement was located in the deck with a top mat of #4 bars at 12 in. (30.5 cm) on center and a bottom mat of #5 bars at 12 in. (30.5 cm) on center. In addition, two (2) #7 bars were placed between the #4 bars in the top of the deck at negative moment sections within the composite girder. In the opposite direction of the girders, the same top mat of #4 bars and bottom mat of #5 bars were placed to prevent temperature and shrinkage cracks.

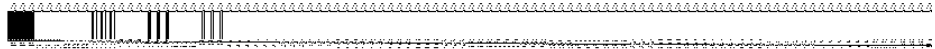
In order to resist the stresses caused by the negative moment, twelve (12) strands were harped at 35.5 ft (10.8 m) from each end of the girder. The harping locations along the girder can be seen in Figure 5.4.



Conversion Units: 1 in. = 25.4 mm; 1 ft = 0.3 m

Figure 5.4 Schematic of strand harp location along half of the girder

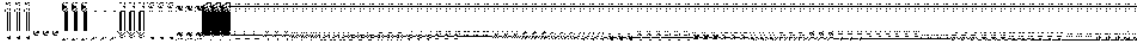
As explained in earlier in Section 5.1, two different bridge designs containing different strand sizes were used in this study to gain a wider understanding of the affects caused by fire damage. Due to the capacity of the strands, the strand pattern for each diameter varied. For the 0.5 in. diameter size forty-four (44) 7-wire, low-relaxation strands were used in the pattern shown. For the 0.375 in. diameter strands, an additional twenty (20) 7-wire, low-relaxation strands were placed in the girder to provide adequate capacity. The strand patterns for the 0.5 in. and 0.375 in. strands can be seen in Figures 5.5 and 5.6 respectively.



\*\*\*\*\*

**Conversion Units: 1 in. = 25.4 mm**

**Figure 5.5 Strand pattern for parametric study with 0.5 in. diameter, 7-wire, low-relaxation prestressing strand**



**Conversion Units: 1 in. = 25.4 mm**

**Figure 5.6 Strand pattern for parametric study with 0.375 in. diameter, 7-wire, low-relaxation prestressing strand**

## **5.2. TEMPERATURE PROFILE**

The temperature profile is dependent on the concrete materials and geometry of the member. Ambient air, wind conditions, and type of concrete play a significant role in the depth and time it takes for heat to travel through the concrete. As discussed in Section 2.6, several methods have been developed to evaluate this temperature profile.

Using published data (PCI Design for Fire Resistance of Precast Prestressed Concrete, 1989; Abrams and Gustaferrero, 1968) and computer modeling (ABAQUS, 2007), isotherm diagrams were developed for the seven (7) periods of time analyzed. These time periods of exposure were 0, 1/2, 1, 1-1/2, 2, 3 and 4 hours. These were chosen because they are based on the standard time-temperature curve given by ASTM E 119-08. Current research up to this point concerning temperature profiles is based on these time increments. By choosing these periods of time, the temperature within the

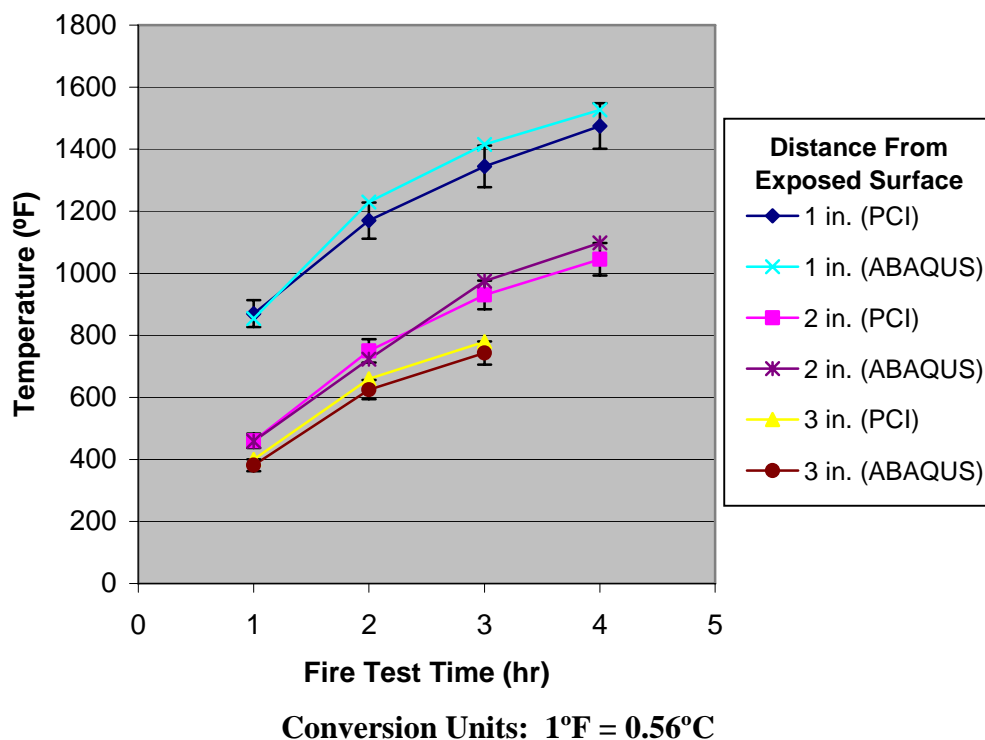
concrete could be directly related to published (PCI Design for Fire Resistance of Precast Prestressed Concrete, 1989; Abrams and Gustaferrero, 1968) temperature plots.

**5.2.1. Standard Time-Temperature Curve.** For the parametric analysis the standard time-temperature curve was applied to the design example. Temperatures for these materials were obtained using the data performed by the Underwriters Laboratories and Portland Cement Association (PCI Design for Fire Resistance of Precast Prestressed Concrete, 1989) and Abrams and Gustaferrero (1968) for beams and slabs respectively.

The published data for beams employed in the standard time-temperature analysis is for rectangular beams. The profiles developed from the data are based on rectangular cross-sections. For our I-beam case a conservative approach was taken and the beam was assumed to be rectangular in size with a width equal to bottom flange width. This assumption is conservative because clearly the temperature would be slightly lower due to the decreased thickness, surface area of the web, and increased temperature dissipation due to the reduced section mass.

**5.2.2. Non-Standard Fire.** In Section 6, several case studies are performed where higher temperatures than that specified by the standard time-temperature curve are evaluated. For that analysis a software program called ABAQUS (2007) was employed to output temperature profiles based on heat exposure and temperature.

The model was calibrated using the Abrams and Gustaferrero's (1968) slab temperature profiles published in the PCI Design for Fire Resistance of Precast Prestressed Concrete, (1989). Figure 5.7 gives the temperature at various fire exposure times both the ABAQUS model and the published PCI data. The illustration shows that the ABAQUS model is indeed representative of the actual temperature within the concrete for a given period of time. A maximum error of 5 percent exists between PCI's data and the calibrated ABAQUS model. This 5 percent error is indicated by the standard deviation bars for each plotted curve.



**Figure 5.7 Verification of ABAQUS calibration to PCI published slab temperatures by Abrams and Gustafsson (1968)**

### 5.3. LOCATION OF FIRE

The location of the fire also plays a significant role in the structural integrity of the bridge. In this study three locations were considered, below the bridge at the critical positive moment section at midspan, above the bridge at critical negative moment sections and above the deck between girders.

**5.3.1. Fire Below the Bridge at the Critical Positive Moment Section at Midspan.** The most significant damage caused by a fire below a bridge would be one that occurs below the structure between supports. This is due to the location of the prestressing strands within the girder where the least amount of clear cover exists. As shown in Figures 5.4 and 5.5, all of the strands are located in the bottom of the girder for interior spans. Thus, an increase in temperature will significantly affect the properties of these strands closest to the fire source and the overall structural capacity.

**5.3.2. Fire Above the Bridge at Critical Negative Moment Sections.** For negative moment sections the strand pattern configuration is slightly different than midspan (positive moment) locations. As shown in Figures 5.4 and 5.5 there are twelve (12) strands located in the top of the cross-section at the ends of the member. This end location also corresponds to the critical negative moment location. Consequently, a fire located directly above this girder will be closer in distance to these strands as well as the deck concrete, girder concrete and mild reinforcement. To estimate the damage caused at this location the composite action of the girder and deck were taken into consideration. The effective flange based on AASHTO 4.6.2.6.1 was calculated.

**5.3.3. Fire Above the Bridge Between Girders.** In addition to the location at the negative moment sections, an investigation was performed for the deck between girders. For this location a 12 in. (304.8 mm) representative segment or strip of the deck was analyzed in the orthogonal direction to the girders. Flexural strength and deflection were characterized by the fire damage to the deck.

## 5.4. MATERIALS

For this design example the prestressed concrete bridge contained three materials, prestressing strands, concrete and mild steel reinforcement. As noted in Section 2.5 all of these materials experience property loss when exposed to high temperatures. Each of these losses were accounted for when performing the study.

**5.4.1. Prestressing Strands.** Within the design example the prestressing strand property losses were characterized by layer. This allowed different material properties to be assigned to the strands based on temperature gradient. The temperature for a particular set of strands was taken as the temperature at the center of the strand layer. Assumed undamaged properties assigned to the prestressing steel were the undamaged values obtained during testing.

**5.4.2. Concrete.** Similarly to the prestressing strands, the concrete properties were also determined by breaking the damage section into layers. Each layer was assessed a damaged value for each property based on the temperature for the particular location.

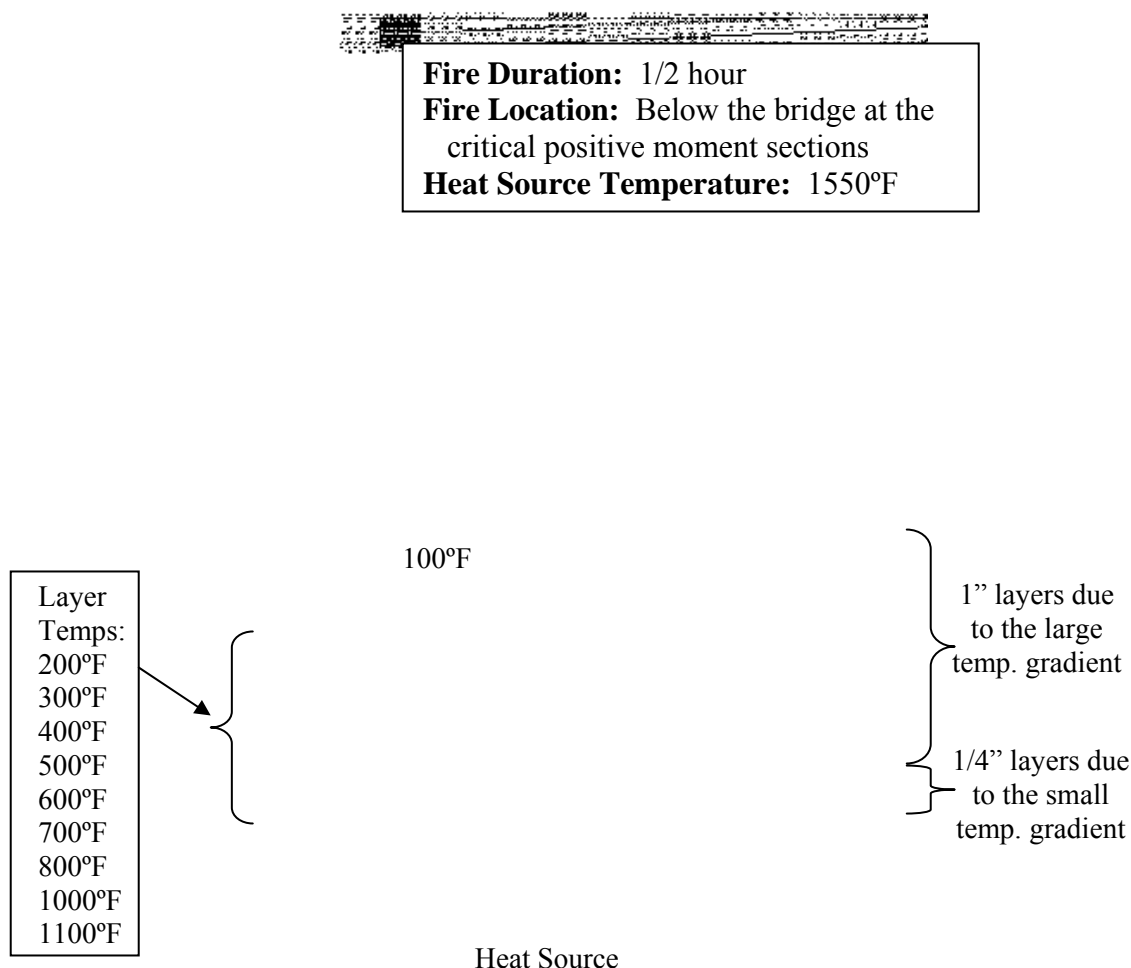


To determine the fire damaged properties for the concrete, the girder was first simplified to a simple I-beam as illustrated in Figure 5.8. Using the appropriate temperature profile (discussed in Section 5.2) the girder was then broken into layers based upon the gradient of the temperatures. For sections of the member where the difference in temperature was small compared to depth, smaller layers of 0.25 in. (6.35 mm) were used. Likewise for areas where the difference in temperature gradient was large, a layer height of 1 in. (25.4 mm) was used. A large difference in temperature gradient was defined as a 1 in. (25.4 mm) area where there was less than a difference of 100°F (37.8°C). Values for the concrete properties were accessed to the entire layer based on the temperature of the edge of the layer. A schematic of how the layers were applied to the temperature profile for a 1/2 hour below the bridge is shown in Figure 5.9.



**Conversion Units: 1 in. = 25.4 mm; 1 ft = 0.3 m**

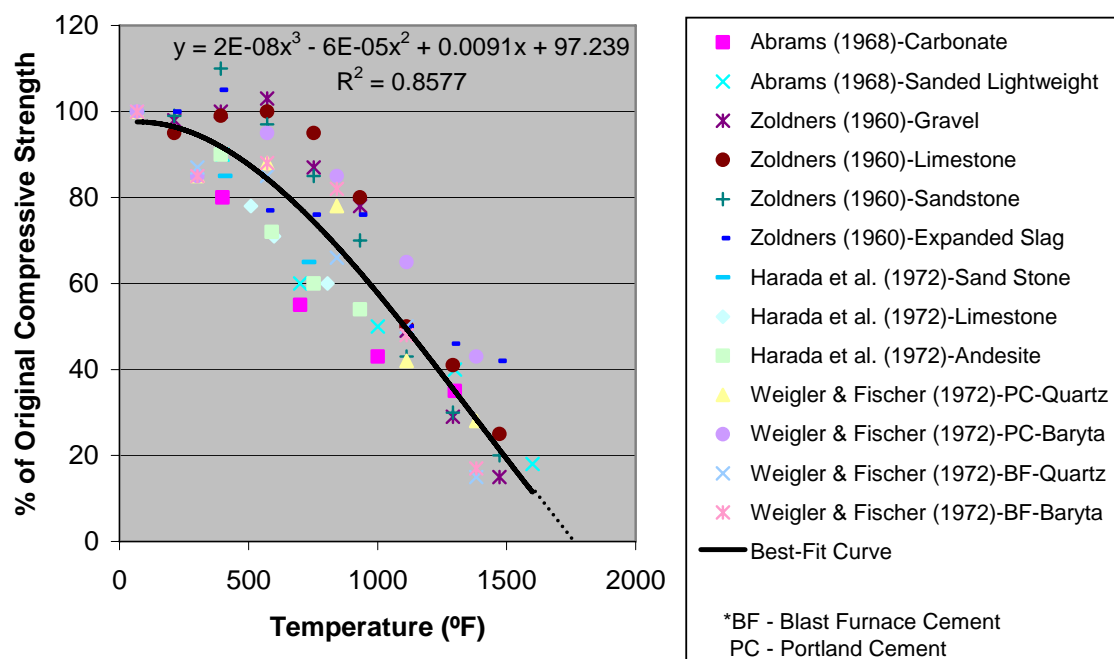
**Figure 5.8 Schematic of simplified I-beam used in temperature analysis**



**Conversion Units: 1 in. = 25.4 mm; 1°F = 0.56°C**

**Figure 5.9 Schematic of bottom flange of I-beam with arbitrary concrete material layers indicated**

**5.4.2.1 Compressive strength.** Using the data discussed in Section 2.5.1, a best-fit curve was utilized to estimate the fire damaged compressive strength of the concrete. This line and the data are presented in Figure 5.10. The trend line approximation is given in Equation 5.1 and is also shown in Figure 5.10 with the  $R^2$  value. The dotted line suggests a projected trend beyond current available published data.



Conversion Units:  $1^{\circ}\text{F} = 0.56^{\circ}\text{C}$

**Figure 5.10 Residual compressive strength of concrete vs. temperature**

$$y = 2 * 10^{-8} x^3 - 6 * 10^{-5} x^2 + 0.0091x + 97.239 \quad \text{Equation 5.1}$$

Based on the temperature of each layer, the residual compressive strength given by the best-fit curve was applied as a percentage of the original length of the layer. This length value was multiplied by the layer height to obtain an area. The total area for the damaged girder was calculated and divided by the area of the undamaged girder to determine a percent of original compressive strength for the member. This percentage was then multiplied by the appropriate  $f'_c$  in the design example to determine the damaged compressive strength. For the locations where the deck was only affected, the deck compressive strength was only altered. Likewise for the location where the girder was only damaged, the girder compressive strength at 28 days was altered.

**5.4.2.2 Modulus of elasticity and moment of inertia.** The damaged stiffness or stiffness loss due to fire was calculated much like that of the  $f'_c$  property, in that each

layer's  $I_c$  was determined by using published data of the residual  $E_c$  due to temperature. These values were given by Equations 2.4 and 2.5 (Chang et al., 2006). As noted in the literature view these equations all only valid up to 1472°F (800°C). However, the percentage of residual modulus given at 1472°F (800°C) is very small and can conservatively be taken as 0 percent. Therefore, for temperatures exceeding 1472°F (800°C), the modulus of elasticity values of the damaged concrete were assumed to be 0 percent.

In contrast to the compressive strength which was normalized using areas of each layer, the stiffness was based on the damaged moment of inertia value for each layer. The percent of original modulus of elasticity was multiplied by the moment of inertia for each layer. The values were then added together to obtain a total moment of inertia. The damaged  $I_c$  was then placed directly into the parametric study. The neutral axis determined from these calculations was also entered into the design example as the distance from the centroid to the extreme top fiber,  $y_t$ . The damaged moment of inertia included the overall fire damage effects caused to the stiffness. The value for the damaged modulus of elasticity was calculated using Equation 5.2 which is specified is given as LRFD Equation 5.4.2.4-1.

$$E_c = 33,000(W_c)^{1.5} \sqrt{f'_c} \text{ (psi)} \quad \text{Equation 5.2}$$

**5.4.3. Mild Reinforcing Steel.** In this particular bridge design, mild reinforcing steel was placed in the deck to resist the negative moment and provide structural support for the deck itself. As explained in Section 5.1.4, the reinforcing detail consisted of a top mat with #4 bars at 12 in. (30.48 cm) on center with two (2) #7 bars at 4 in. (10.16 cm) on center within each #4 bar space. The bottom mat design was #5 bars at 12 in. (30.48 cm) on center. In addition, a top mat of #4 bars at 12 in. (30.48 cm) on center and a bottom mat of #5 bars at 12 in. on center were placed in the deck in the orthogonal direction to the girders to prevent cracking due to temperature and shrinkage.

Previous data for grade 60 mild reinforcing steel discussed in Section 2.5.2 (Dias, 1992 and Edwards and Gamble, 1986) was used to correct the steel tensile strength for fire damage.

## 5.5. HYDROCARBON POOL FIRE CALCULATIONS

A typical cause for bridge fires is an accident involving a chemical spill. In the case of burning fuels or combustible liquids (referred to as hydrocarbon pool fires) the temperature is often higher than that of standard fires. The fire produced by these spills is characterized by the volume of the spill, leak rate, bridge geometry, bridge material which it flows onto, ambient temperature, wind conditions and type of chemical spilled. These characteristics dictate the size and extent of the fire.

Based on the given spill volume, type of chemical spilled and size of bridge, calculations can be made to determine the diameter of damage, duration of fire and temperature of fire. Using this calculated data, the damage to the prestressing strands, concrete and mild reinforcing steel can then be quantified.

In order to determine the properties of a fire caused by a chemical spill the diameter of the pool must be calculated first. The equation for the maximum diameter of an unconfined spill is given as Equation 2.7 in Section 2.6.2.1. The lesser of either the maximum diameter or the unconfined area is taken as the diameter. For the design example the bridge width is 42 ft (12.8 m) and will likely be taken as the diameter of the spill.

The diameter of a pool and duration of fire are inversely related. The smaller the size of the pool the longer the fire will burn and in turn cause higher temperatures to occur. Locations where the pool is allowed to grow exponentially result in shorter fires. This inverse relationship is caused by the thickness of the chemical.

Using the diameter, the duration can be calculated by using Equations 2.8 and 2.9 from Section 2.6.2.1. The mass burning rate and liquid density values in the equation are properties of the spilled chemical.

Flame temperatures are determined based on the material. For any given fire the temperature varies throughout the flame, therefore the temperature reported is average flame temperature. As noted in Section 2.6.2.1, the flame temperature can also vary upon size of the pool fire.

Published investigations (*Aspire*, Spring 2008; FHWA, 2007) of prior bridge fires indicated temperatures 1500°F-2000°F (816°C-1093°C) greater than the average flame temperature reported. Therefore, for this particular analysis the peak temperature or documented temperature (if provided) was used. In addition for studies in which the temperature was provided, an estimated temperature was used which represented the worst case scenario.

## 5.6. ASSUMPTIONS

Several assumptions were made to quantify the results of the parametric study. This was necessary to refine the study in combination with the uncertainty of the behavior of fire. Due to an infinite number of factors, a fire at the same location and of the same type may have a different response day to day. The assumptions made for this study are discussed further in the following sections.

**5.6.1. Fire Effects Entire Length of Girder Equally.** For this analysis the equations and methods used assume uniformity of member properties along the entire span. In the case of a fire, the member may only be damaged for a section or small portion of the span. However, in this study a worst case scenario was analyzed and the damage accrued at one point of the bridge was assumed to exist along the entire length of the girder.

**5.6.2. Environmental Effects.** Wind and ambient air were not included in the parametric study. Depending on the climate of a particular region and time of year, the fire behavior will be highly variable. For this study, the environment was assumed to be without wind and unaffected by the ambient temperature.

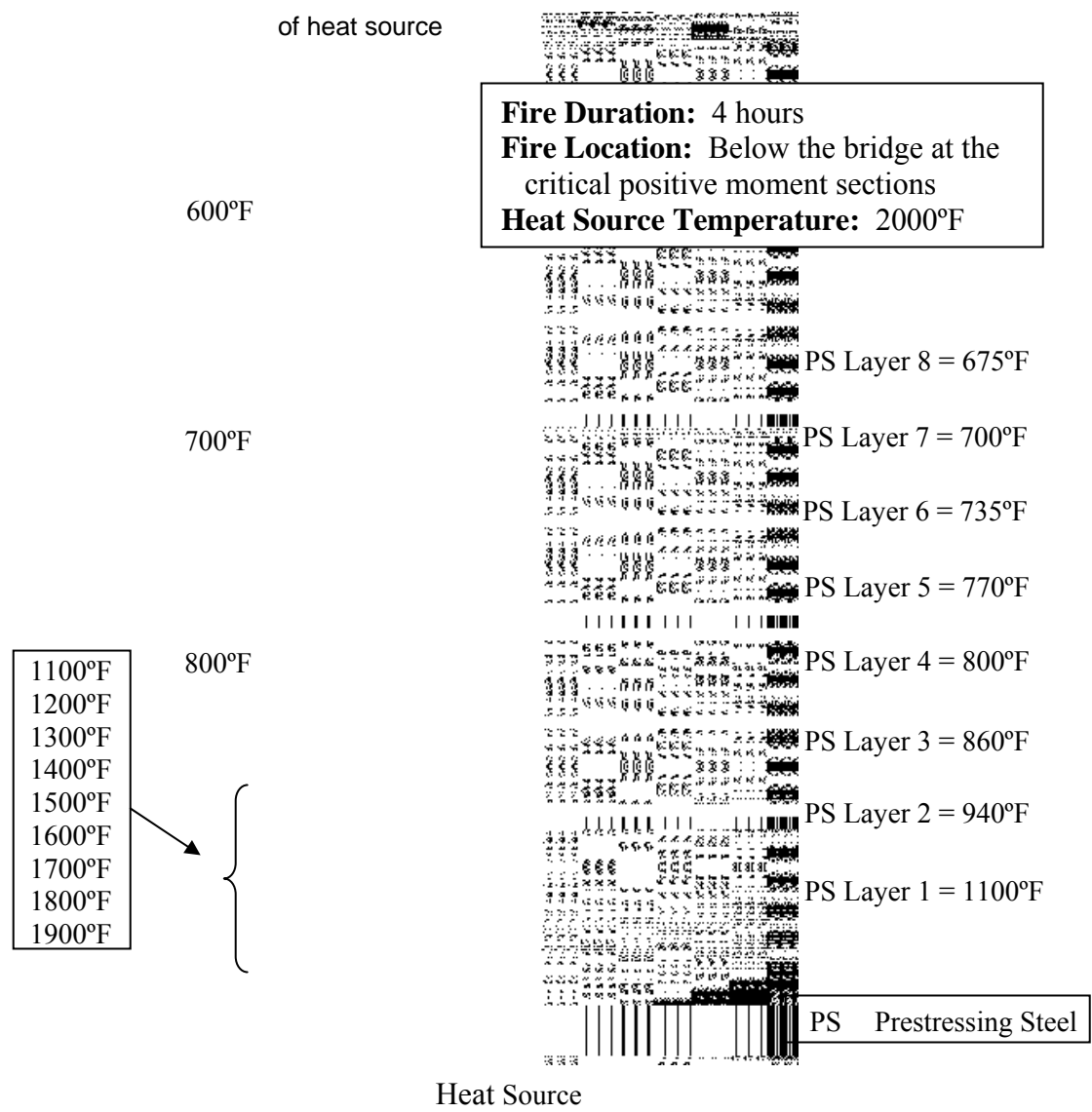
For case studies developed Section 6, information was obtained by calculations and engineer investigations performed during and after the fire. Reports did not indicate weather conditions during each fire, but various conditions would have obviously existed.

## 5.7. STUDY RESULTS

The following results in Section 5.7 are based on a standard fire (ASTM E 119-08) occurring to the PCI Bridge Design example specified in Section 5.1. Bridge design details, material properties and assumptions have been applied as detailed in Sections 5.1, 5.4 and 5.6 respectively. Results are provided for both 0.5 in. and 0.375 in. bridge designs. Because this section was based on standard fires, all temperature profiles were developed using published data (PCI Design for Fire Resistance of Precast Prestressed Concrete, 1989; and Abrams and Gustaferro, 1968). Non-standard fires involving hydrocarbon pool fires are addressed in Section 6 and are not included in the following results. Similarly, the ABAQUS software used to model non-standard fires was also not employed in the section.

**5.7.1. Fire Below the Bridge at the Critical Positive Moment Section at Midspan.** As explained in Section 5.3, a fire occurring below a girder at midspan for this particular design example is critical because all of the prestressing strands are located in the bottom of the girder. The strand vulnerability will affect the moment capacity of the section as well as the serviceability behavior which are quantified by deflection.

Figure 5.11 shows a sample temperature profile based on PCI Design for Fire Resistance of Precast Prestressed Concrete (1989). This particular sample profile is for a fire occurring below the girder at the critical positive moment section after an exposure of 4 hours for a girder with 0.5 in. strands. The 4 hour exposure was the longest period of time examined and therefore the most severe case. You will note that all of the steel is significantly affected by the elevated temperatures. Based on the temperature profile, the fire damaged compressive strength and moment inertia values were calculated for each fire duration. These values can be seen in Table 5.2.



Conversion Units: 1°F = 0.56°C

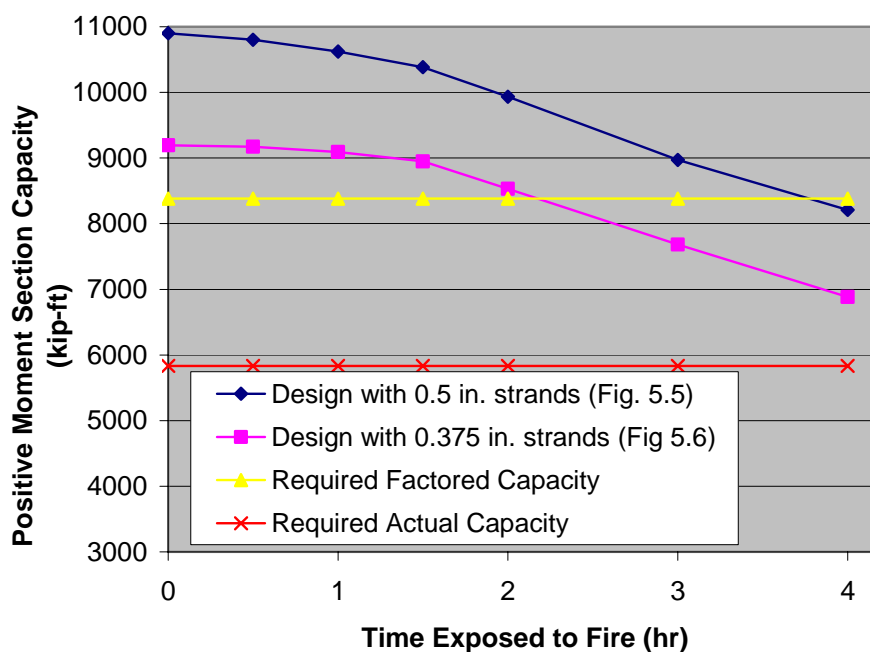
**Figure 5.11 Temperature profile for half of the 0.5 in. girder cross-section for a 4 hour fire occurring below the bridge at the critical positive moment section at midspan**



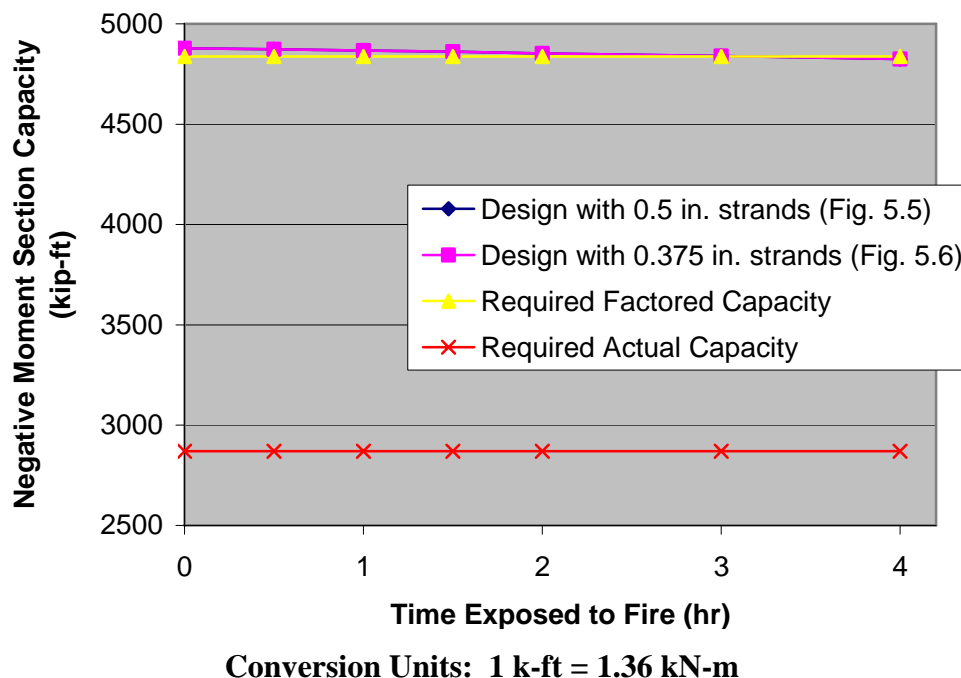
**Table 5.2 Fire damaged girder compressive strength and non-composite moment of inertia values**

	Undamaged	½ hour	1 hour	1-1/2 hour	2 hour	3 hour	4 hour
$f'_c$ (psi) (MPa)	7,000 (48.3)	6,790 (46.8)	6,570 (45.3)	6,410 (44.2)	6,170 (42.5)	5,800 (40.0)	5,460 (37.6)
$I_c$ (in <sup>4</sup> ) (m <sup>4</sup> )	539,947 (0.216)	482,740 (0.193)	440,915 (0.176)	412,327 (0.165)	363,218 (0.145)	322,319 (0.129)	211,427 (0.085)

Below the bridge at the critical positive moment section at midspan, the moment capacities show an immediate decrease in flexural strength upon initial fire exposure. Figures 5.12 and 5.13 illustrate the moment section capacity of the girders with exposure to fire time. From the figure it is clear that despite the undamaged moment capacity, each design (0.5 in. and 0.375 in.) behaved in a similar manner with time.



**Figure 5.12 Positive moment section capacity vs. time exposed to fire**



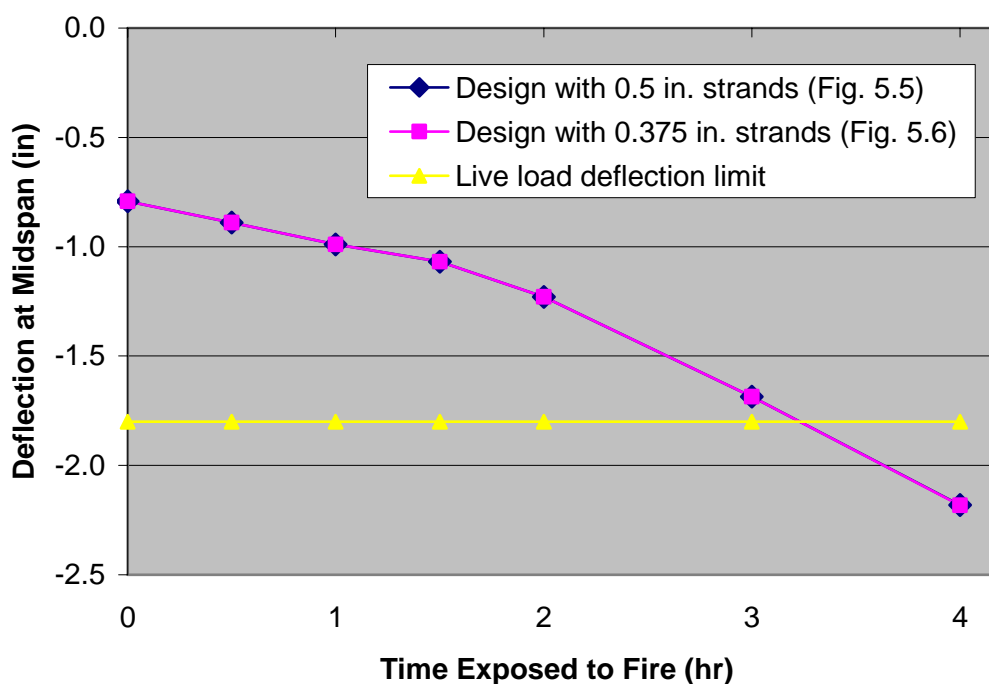
**Figure 5.13 Negative moment section capacity vs. time exposed to fire**

In Figures 5.12 and 5.13, the “Factored Required Section Capacity” is the  $M_u$  in which engineers must meet to properly design the bridge per the LRFD Bridge Design Specifications (1998). The “Actual Required Section Capacity” is the unfactored moment which the girder will experience. As discussed in Section 5.1.2, this is an unconservative estimate used in this study as a point of reference. Overall the girder performs well up to a burning duration range of 2 to 3 hours. At that point the girder with 0.375 in. strands falls below the positive moment factored demand. The girder with 0.5 in. strands does not fail this limit until a fire of duration of 4 hours. However, despite the failure of these limits, the girders remain over 1000 kip-ft (1356 kN-m) above the actual moment section capacity expected to be felt by the girder.

Minimal negative moment section capacity is lost during the 4 hour duration. This is due to the location of the fire being away from the negative moment steel. The decrease in the capacity is due to the loss of concrete compressive strength and stiffness

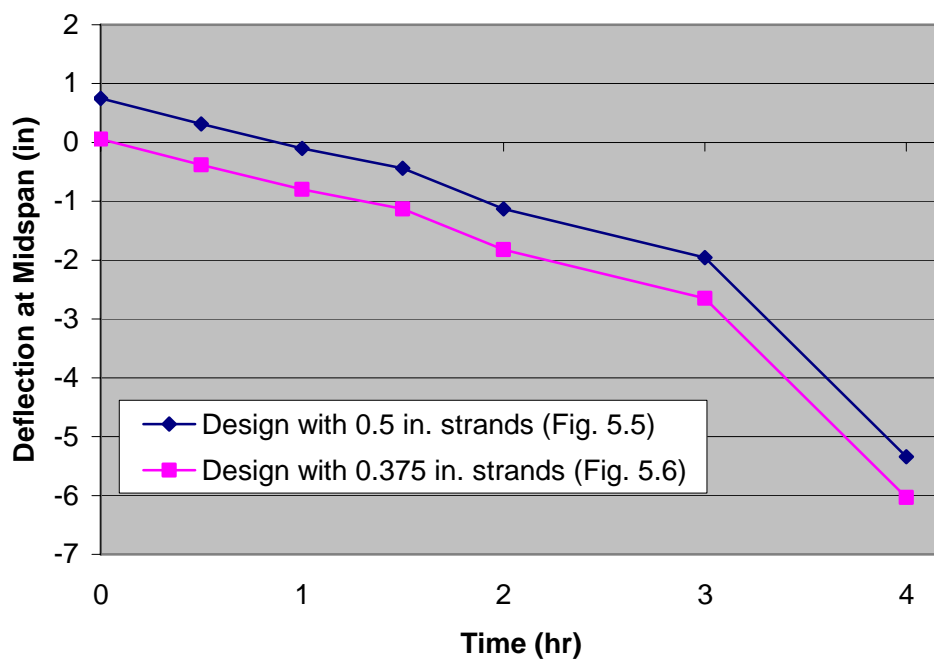
However, despite the small decrease in capacity the required factored capacity is still failed after 2 hours. This is mainly due to the small difference in undamaged capacity and the required capacity. In terms of the Required Actual Capacity limit, the negative moment remained over 1500 kip-ft (2035 kN-m) greater than the “Actual Required Capacity” at 4 hours.

Deflection due to self-weight and live load for the girders can be seen in Figures 5.14 and 5.15 respectively. After a fire duration of 1-2 hours the self-weight deflection is approximately 2 in. due to the decrease in stiffness of the member. After 2 hours, the deflection becomes quite severe, sagging close to 6 in. (152.4 mm). Failure of the live load and impact limit occurs between 3 and 4 hours for both girders.



Conversion Units: 1 in. = 25.4 mm

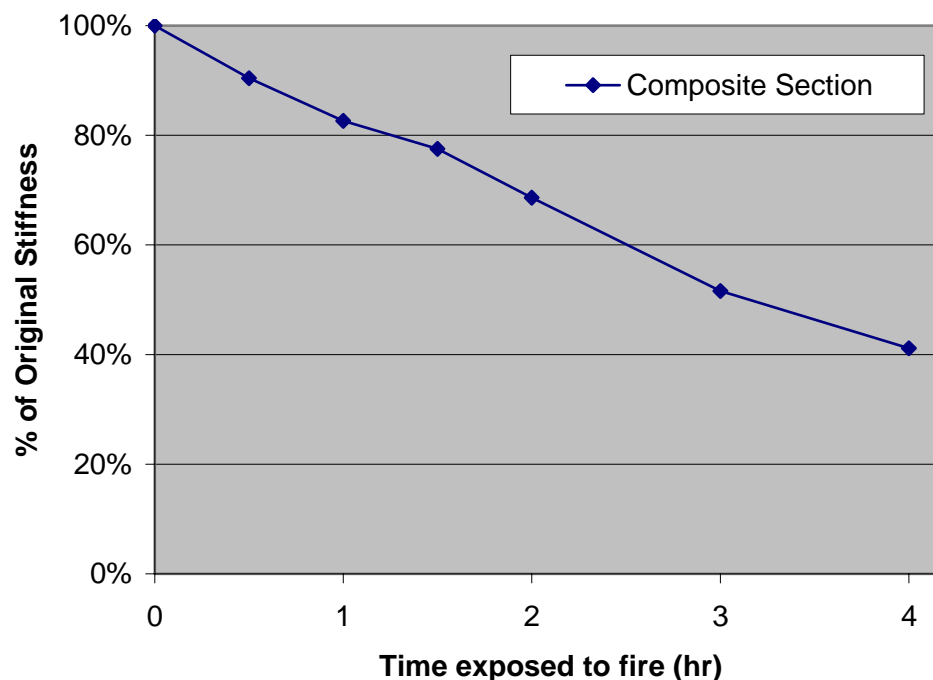
Figure 5.14 Deflection at midspan due to live load vs. time exposed to fire



Conversion Units: 1 in. = 25.4 mm

**Figure 5.15 Deflection at midspan due to self-weight vs. time exposed to fire**

In Figure 5.16, the loss in stiffness is illustrated for the composite girder. Although the non-composite section was directly affected by the fire, the composite section is presented so that all three locations can be easily compared. The non-composite section is used to calculate the composite section, therefore the loss in stiffness is still included with the composite section. Graphically, it can be seen that the stiffness begins to consistently decrease as the time of fire exposure increases. After only one hour, almost 20 percent of the stiffness is lost and an additional 14 percent is lost in the second hour. Subsequently, 17 percent and 10 percent are lost within the next two hours of burning. After 4 hours, only 41 percent of the original stiffness remains in the member. This remaining stiffness is located predominantly in the top of the member where the heat source is farthest away from the material.



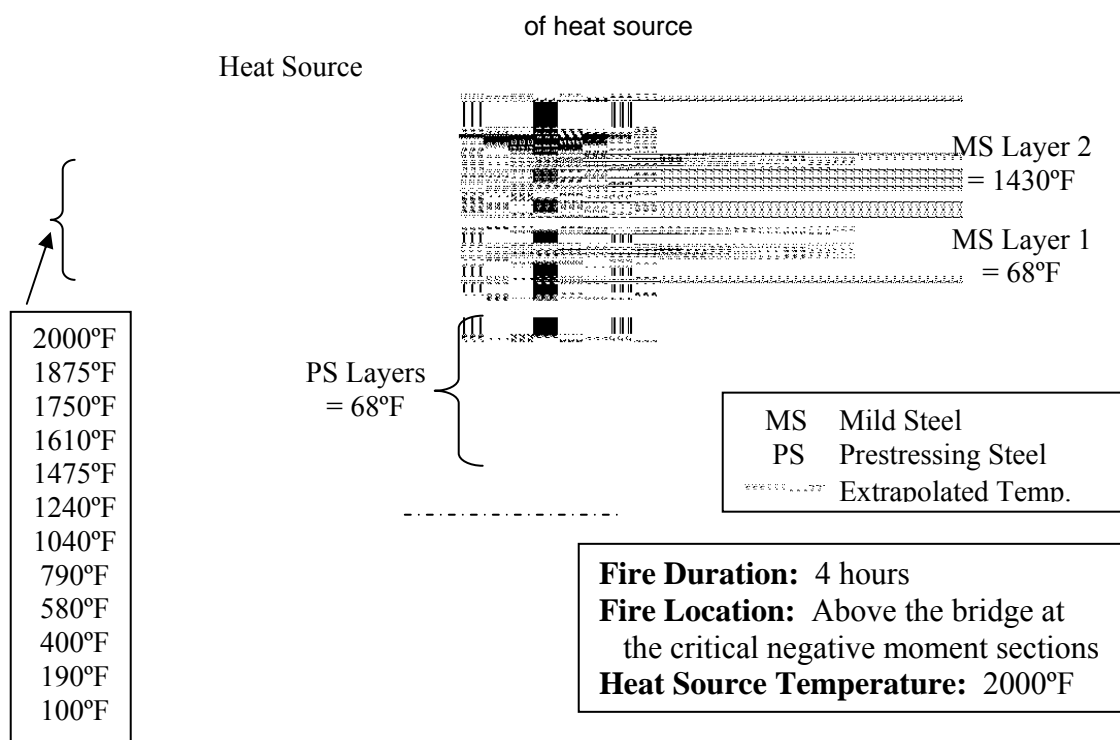
**Figure 5.16 Stiffness loss of composite girder vs. time exposed to fire**

Based on the results for the parametric study for a fire occurring below the bridge at the critical positive moment section capacity at midspan, it can be concluded that the bridge would be able to sustain service loads following a fire of short duration (1-2 hours). However, the deflection due to this length of burning will cause uneasiness among occupants and should be examined. It is recommended that visual observations are performed and the girders repaired accordingly to prevent durability issues. For fires occurring longer than 2 hours, the deflection would be too severe for service. In addition, the flexural capacity would not be adequate to satisfy the code mandated load factors given in Section 5.1.2. It is recommended that appropriate repairs are made before returning the bridge to service. This will include the possibility of building a new bridge.

**5.7.2. Fire Above the Bridge at Critical Negative Moment Sections.** For this location, the fire was applied to the top of the bridge at the critical negative moment section and analyzed using four different periods of time. A composite section was analyzed which included the 8 in. (20.32 cm) thick deck with an effective width of 111

in. (2.82 m). The mild steel reinforcement includes the top mat of #4 bars, the bottom mat of #5 bars and the additional #7 bars placed in the composite girder at negative moment sections as described by Section 5.1.4. The prestressing steel analyzed is the twelve (12) harped strands which were also previously explained in Section 5.1.4.

A temperature profile developed from Abrams and Gustaferro's (1968) slab profiles for the 4 hour case is illustrated in Figure 5.17. The temperature profile layers are shown in the deck by solid and dotted lines. The dotted lines shown in the profile represent data extrapolated from the published temperature plots. It is interesting to note, that even after 4 hours the fire does not affect the prestressing steel located in the top of the girder or the girder itself. The heat remains in the deck throughout the duration of the fire.



Conversion Units: 1°F = 0.56°C

**Figure 5.17** Temperature profile for composite girder at critical negative moment sections

The fire damaged properties for the bridge can be seen in Table 5.3. The  $f'_c$  given is the compressive strength of the deck, because it was the only component affected by the fire. The  $I_c$  value shown is the moment of inertia for the composite section, which was affected by the change in the moment of inertia of the deck.

**Table 5.3 Fire damaged deck compressive strength and composite moment of inertia values**

	Undamaged	1/2 hour	1 hour	1-1/2 hour	2 hour	3 hour	4 hour
$f'_c$ (psi) (MPa)	4,000 (27.6)	3,740 (25.8)	3,570 (24.6)	3,390 (23.4)	3,250 (22.4)	3,020 (20.8)	2,830 (19.5)
$I_c$ (in <sup>4</sup> ) (m <sup>4</sup> )	1,091,316 (0.437)	1,059,263 (0.424)	1,043,643 (0.417)	1,029,799 (0.412)	1,018,835 (0.408)	1,001,882 (0.401)	988,159 (0.395)

Figures 5.18 and 5.19 give the positive and moment section capacities for this parametric study. As suggested by the temperature profile results, the moment capacities are significantly less than the previous location, because the prestressing steel was not affected. The deck concrete and mild steel reinforcement are the only materials that experienced damage.

The positive moment section capacity remained nearly the same as the undamaged capacity, only decreasing slightly with time. This slight decrease is due to the decrease in the compressive strength of the deck concrete.

Due to the compromise of the mild steel properties, the negative moment capacity decreased significantly and failed the “Required Factored Capacity” after only 30 minutes of fire exposure. However, as before, this capacity remained much larger than the “Actual Required Capacity” which means the fire would not cause flexural collapse.

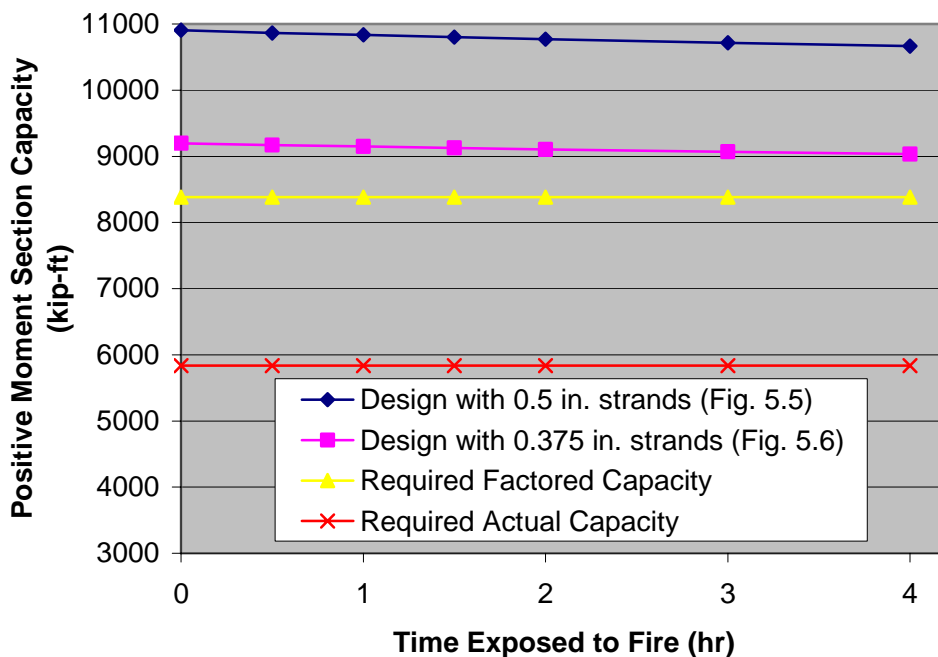


Figure 5.18 Positive moment section capacity vs. time exposed to fire

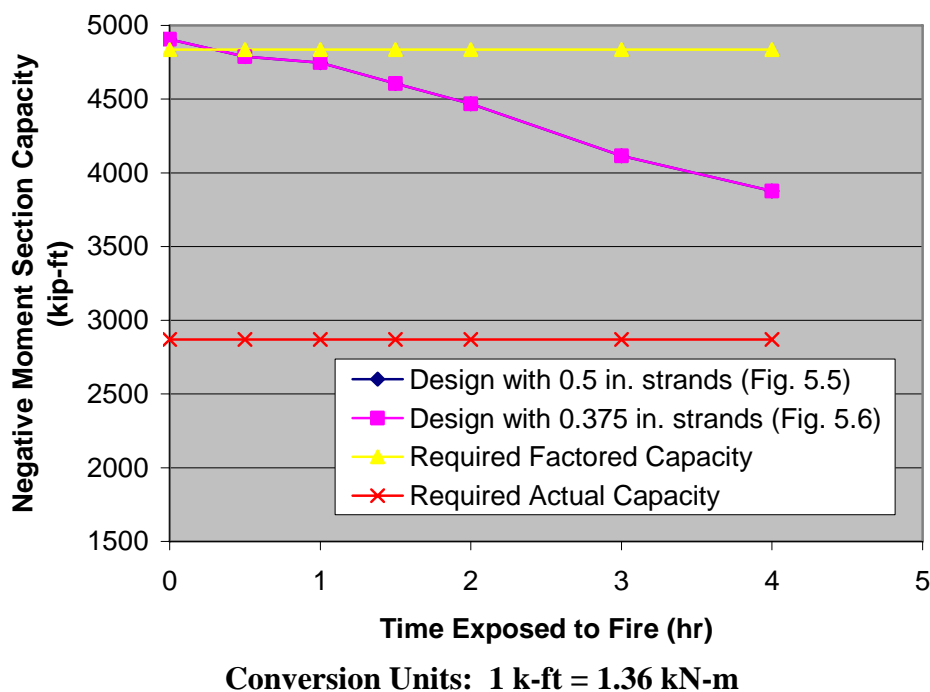
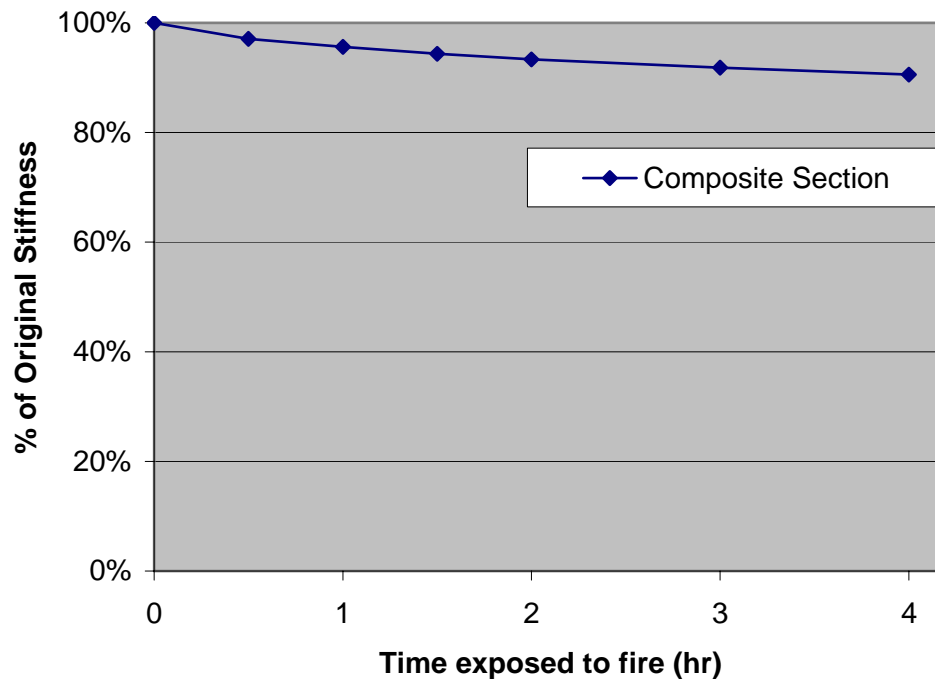


Figure 5.19 Negative moment section capacity vs. time exposed to fire

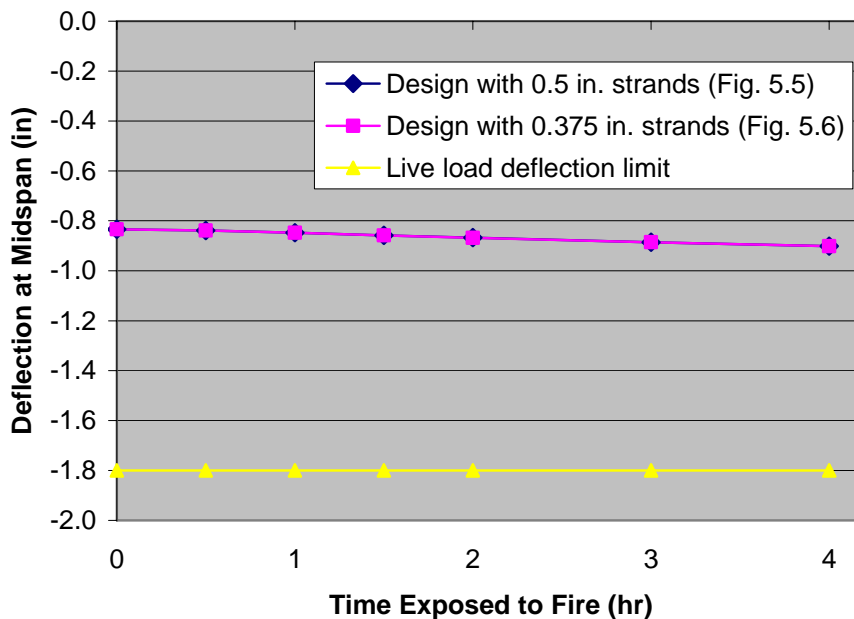


The loss in stiffness of the composite girder is given in Figure 5.20. There is considerable less stiffness loss accrued by a fire occurring at above the bridge at critical negative moment sections than a fire occurring below the bridge at critical positive moment sections as seen in Section 5.7.1. The overall loss in stiffness for this particular fire is above 90 percent throughout a 4 hour fire.



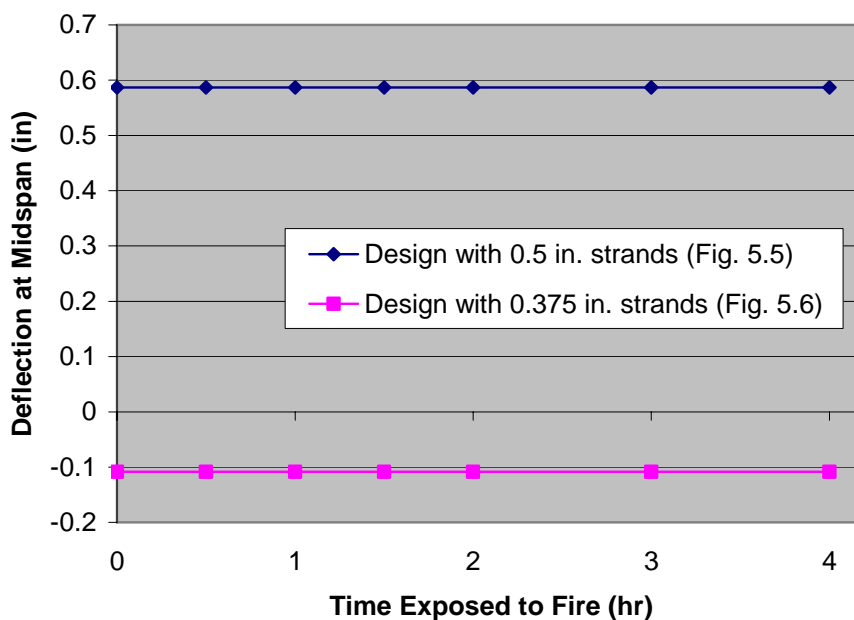
**Figure 5.20 Stiffness loss of composite girder vs. time exposed to fire**

The deflection due to live load and impact is due to the loss in deck stiffness. This increase is quite small, because the deck portion of the composite cross-section is also quite small. For the deflection due to self-weight, there is no increase in deflection, because the girder which carries the dead load is not damaged. Plots of both live load and impact deflection and self-weight deflection can be seen in Figures 5.21 and 5.22.



Conversion Units: 1 in. = 25.4 mm

Figure 5.21 Deflection at midspan due to live load vs. time exposed to fire



Conversion Units: 1 in. = 25.4 mm

Figure 5.22 Deflection at midspan due to self-weight vs. time exposed to fire

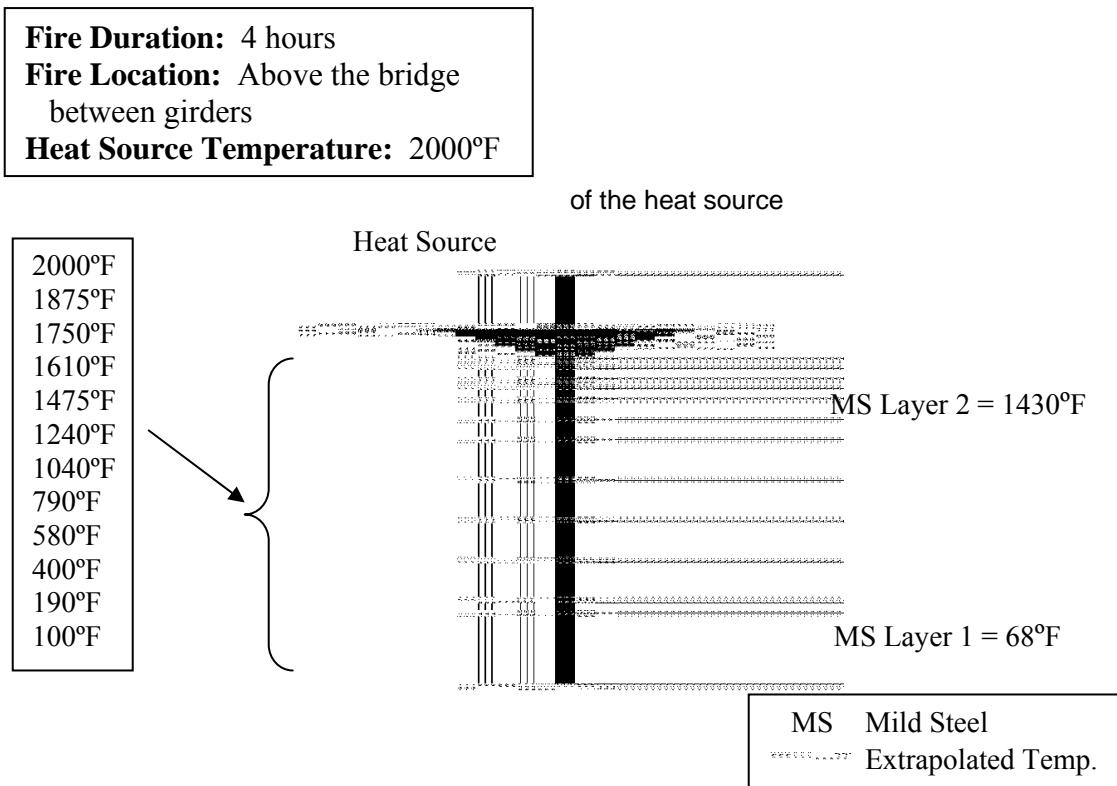
For a given fire at this location, it appears that the negative section capacity will be severely compromised. In addition, the deck surface will have severe issues of spalling and cracking which may lead to durability issues in the future. The bridge is not recommended for use until adequate section capacity is restored to the negative moment sections.

**5.7.3. Fire Above the Bridge Between Girders.** The final location examined in the parametric study is along the deck between girders. Initial concern existed regarding the structural integrity of the unsupported deck after fire in the opposite direction of the girders. To evaluate the effects of the fire along the bridge deck, an arbitrary 12 in. (30.5 cm) strip was selected and analyzed. In this direction mild steel reinforcement consisting of a top mat of #4 bars at 12 in. (30.5 cm) on center and a bottom mat of #5 bars at 12 in. (30.5 cm) on center is provided in the deck for temperature and shrinkage. Damaged property values for the compressive strength and moment of inertia are shown in Table 5.4. For this case the moment of inertia value only reflects the 12 in. (30.5 cm) strip analyzed.

**Table 5.4 Damaged deck compressive strength and deck moment of inertia values**

	Undamaged	1/2 hour	1 hour	1-1/2 hour	2 hour	3 hour	4 hour
$f'_c$ (psi) (MPa)	4,000 (27.6)	3,740 (25.8)	3,570 (24.6)	3,390 (23.4)	3,250 (22.4)	3,020 (20.8)	2,830 (19.5)
$I_c$ (in <sup>4</sup> ) (cm <sup>4</sup> )	512 (21,309)	324 (13,485)	249 (10,363)	200 (8,324)	166 (6,909)	125 (5,203)	99 (4,120)

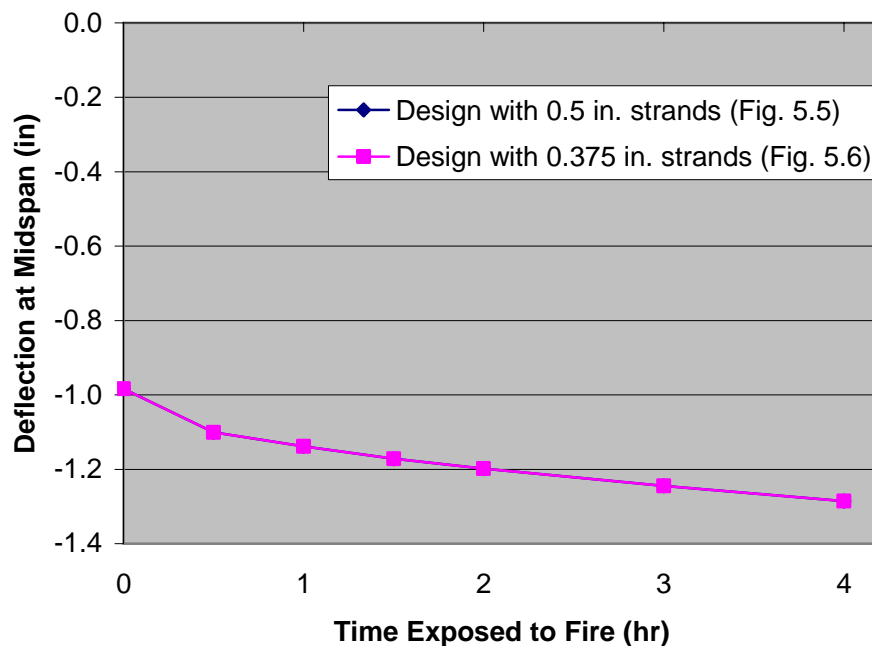
In addition to the damaged property values, the temperature profile is given in Figure 5.23. The temperature shown in this profile are the same as that shown in the composite temperature profile in Section 5.7.2. This is because in both cases the deck is the nearest to the heat source.



**Conversion Units: 1°F = 0.56°C**

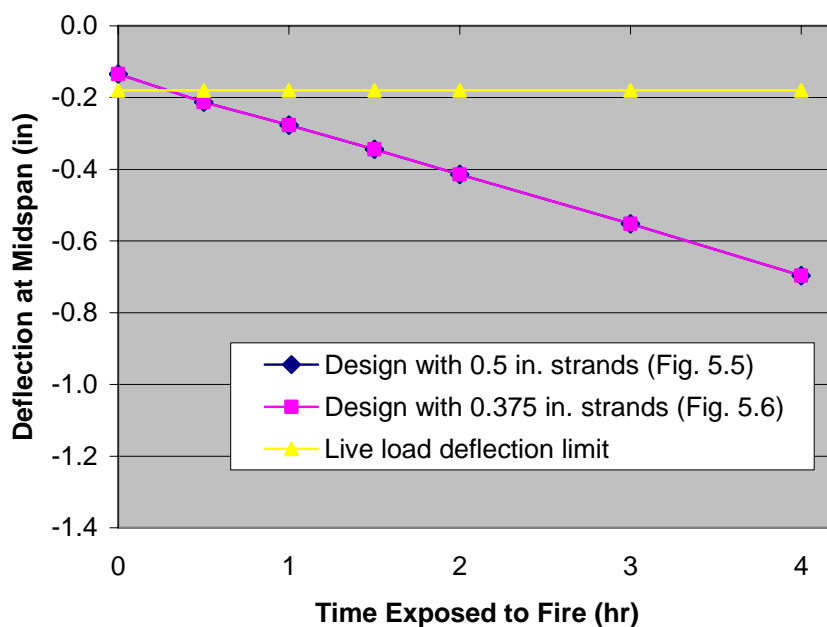
**Figure 5.23 Temperature profile along 12 in. (30.5 cm) width of deck after 4 hours of fire exposure**

As shown in Figure 5.24, a decrease in the self-weight deflection at midspan of approximately 0.3 in. (7.62 mm) takes place over a fire duration of 4 hours. The live load and impact illustrated in Figure 5.25 increases from approximately 0.15 in. (3.8 mm) to approximately 0.7 in. (17.8 mm) over the same time period. For previous locations these values for live load deflection would be acceptable, however, for this case the span is only 12 ft (3.7 m) and therefore the LRFD live load limit ( $l/800$ ) is 0.18 in. (4.6 mm). Consequently, the limit is failed immediately with a deflection just greater than 0.2 in. after a half hour of fire exposure.



Conversion Units: 1 in. = 25.4 mm

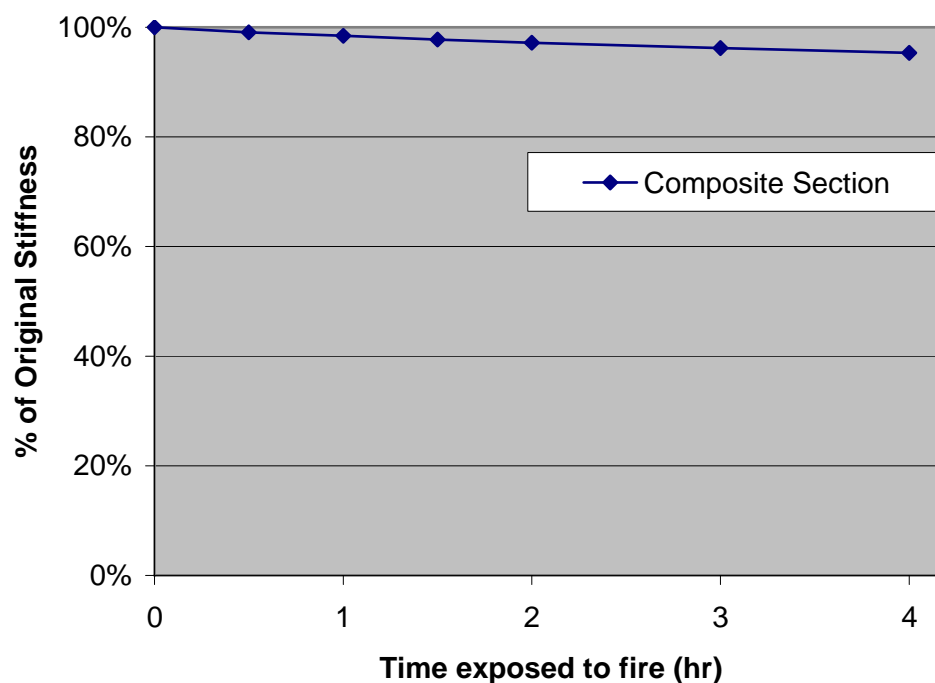
Figure 5.24 Deflection due to self-weight vs. time exposed to fire



Conversion Units: 1 in. = 25.4 mm

Figure 5.25 Deflection due to live load vs. time exposed to fire

The loss in stiffness is presented in Figure 5.26. The total stiffness loss after four hours of fire exposure is less than both the fire located below the bridge at critical positive moment sections and the fire located above the bridge at critical negative moment sections. This minimal stiffness loss is due to the small area affected by the fire. Because this fire is located above the bridge between girders, the deck is the only component of the structure affected. Therefore, a higher amount of stiffness is retained by the structure after fire exposure.



**Figure 5.26 Stiffness loss of composite girder vs. time exposed to fire**

Overall, it appears that the deck between spans would not perform suitably according to code limits. The deflection would cause problems for traffic crossing the bridge. In addition, severe spalling and cracking will occur which will lead to durability issues. Depending on the duration of fire exposure, the deflection may be minimal and after a detailed inspection and approval by a professional engineer the bridge could be

immediately opened. Realistically, this scenario of a fire occurring on the bridge deck between spans would be accompanied by additional fire along the bridge span and at negative moment sections. A situation such as that would need to be analyzed using this location and the other locations affected by the fire.

## 6. FIRE EXPOSED CASE STUDIES

### 6.1. GENERAL

Included in this section are three case studies of fire damaged prestressed concrete bridges. In each case study, reported information regarding the size, duration and temperature of the particular fire has been applied to the PCI Design example discussed in Section 5. Assumptions and procedures discussed in Section 5 were also applied to these case studies with the exception of the method of determining the temperature profile. In this section, the temperature profiles were developed using ABAQUS finite element modeling software, because each of the case studies involved a non-standard (hydrocarbon) fire and current published data (PCI Design for Fire Resistance of Precast Prestressed Concrete, 1989; and Abrams and Gustaferro, 1968) is only for standard fires. In addition, information and equations from Section 5.5 for hydrocarbon pool fires were also applied to these studies to determine the fire duration, size of fire and temperature, if this information had not already been documented.

### 6.2. U.S. ROUTE 7 BRIDGE (RIDGFIELD, CT)

**6.2.1. Accident.** On July 12, 2005, a tanker carrying 8,000 gallons (30,300 liters) of unleaded gasoline overturned and caught fire on U.S. Route 7 Bridge. The accident occurred near Ridgefield, Connecticut over the Norwalk River. The bridge spanned 48 ft. (14.6 m) and held two lanes of traffic and two shoulder lanes. Initial observations noted “scaling of the concrete surface had occurred on the bottom flanges of all fifteen (15) beams as well as on the exterior faces of the fascia beams”. This inspection led the Connecticut Department of Transportation to decide to replace the entire bridge. Based on the melting of the aluminum tanker truck, the temperature of the fire was estimated to be 4472°F (2467°C). Photos of the bridge and tanker after the fire can be seen in Figure 6.1. (FHWA, 2007)





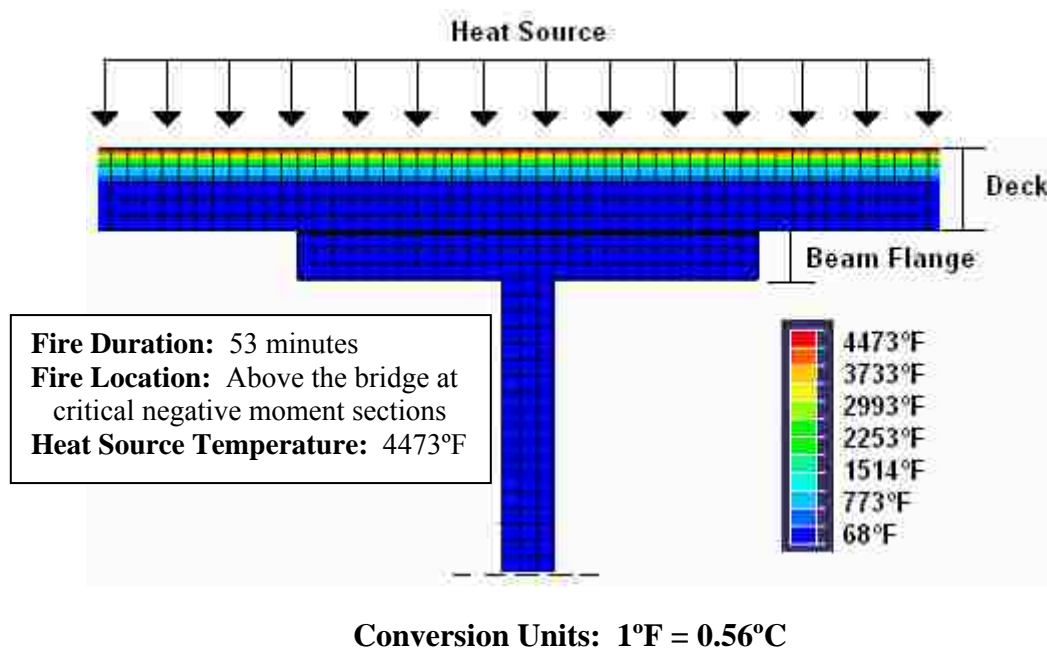
**Figure 6.1** Aftermath of the bridge fire along U.S. Route 7 Bridge near Ridgefield, Connecticut (FHWA, 2007)

**6.2.2. Parametric Study.** Using Equation 2.7, the maximum diameter of 331.7 ft. (101.10 m) was calculated for the tanker spill. However, the diameter was limited by the width of the bridge which is 42 ft. (12.8 m). Based on the actual diameter and the maximum diameter possible, the fire duration was determined to be 53 minutes. As explained in Section 2.6.2.1, the average flame temperature does not reflect the peak temperatures which occur within a flame. For this bridge fire, this is the case as the average flame temperature for gasoline is given as 1879°F (1026°C) but the visual observations at the site estimated the temperature to be 4473°F (2467°C). The observed value is expected to be more accurate due to actual observations performed by investigators. Due to this, the estimated value was used in the study evaluation.

An ABAQUS model was developed based upon the typical flame temperature and duration of fire. Simulating the actual fire, the theoretical model consisted of a fire on the deck of the bridge which burned for 53 minutes. Based on this input data, a temperature profile was developed and the bridge properties were applied to the study accordingly.

**6.2.3. Conclusions.** The temperature model obtained using ABAQUS is illustrated in Figure 6.2. Each element shown represents approximately 1.6 in. (40.64 mm) tall and 2 in. (50.8 mm) wide. The applied temperature of 4473°F (2467°C) was much greater than the 2000°F (1093°C) specified for 4 hours in the standard parametric study. However, despite the increase in temperature the depth the heat travels is quite

minimal. This is due to the short duration of the fire and the intensity at which the fire was applied. Normalized compressive strength and stiffness values are given in Table 6.1.



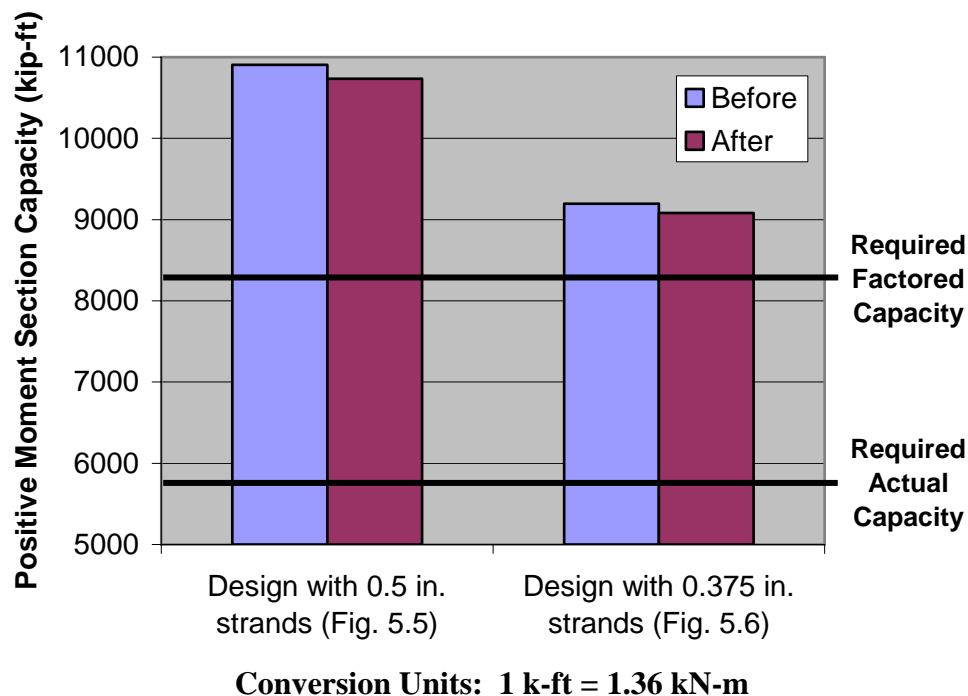
**Figure 6.2** Temperature profile for fire on bridge deck (ABAQUS, 2007)

**Table 6.1** Fire damaged deck compressive strength and composite moment of inertia values before and after the fire

	Before	After
$f'_c$ (psi)	4,000	3,090
(MPa)	(27.6)	(21.3)
$I_c$ (in <sup>4</sup> )	1,091,316	1,025,013
(m <sup>4</sup> )	(0.437)	(0.410)

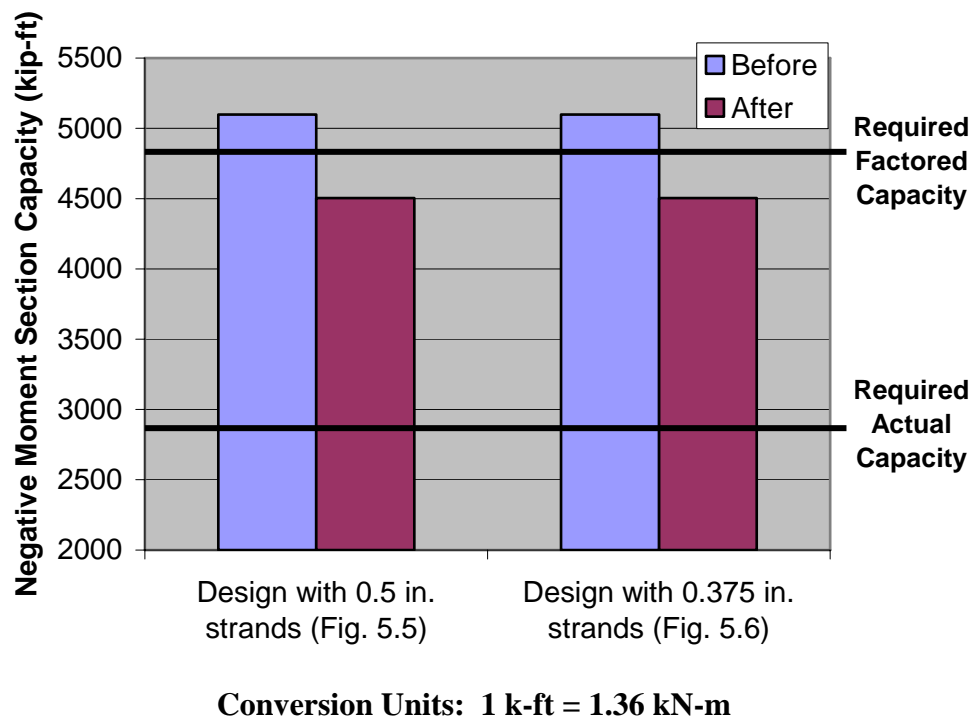
Using the temperatures output by the ABAQUS program, the moment capacities and deflections were calculated as previously described. Figure 6.3 shows the positive

moment section capacity for each girder, before and after the fire. You will note that very little positive capacity is lost during the fire. Again this loss is due to the loss of compressive strength of the concrete deck. The loss is small because the prestressing steel was not affected by the fire.



**Figure 6.3 Positive moment section capacity before and after the fire**

In contrast to the positive moment section capacity, the negative moment section capacity, shown in Figure 6.4, does experience significant loss due to the fire. The mild steel within the deck is severely affected by the intense heat and loses the majority of its tensile strength. In addition, the deck concrete itself is damaged resulting in a loss in compressive strength.



**Figure 6.4 Negative moment section capacity before and after the fire**

The deflection and stiffness for the case study are shown in Figures 6.5 and 6.6 respectively. As seen with the parametric study in Section 5.7, a fire located above the bridge has little effect on the deflection. The deflections show a slight overall increase, but they remain above the live load limit. In terms of stiffness, a 6 percent loss in capacity occurred over the 53 minute fire duration period. This value is slightly higher than the loss in stiffness observed for the standard fire occurring above the bridge at critical negative moment sections. This particular standard fire, which was discussed in Section 5.7.2, experienced a loss of 4 percent after one hour. The higher loss occurring in this case study is due to the increase in temperature.

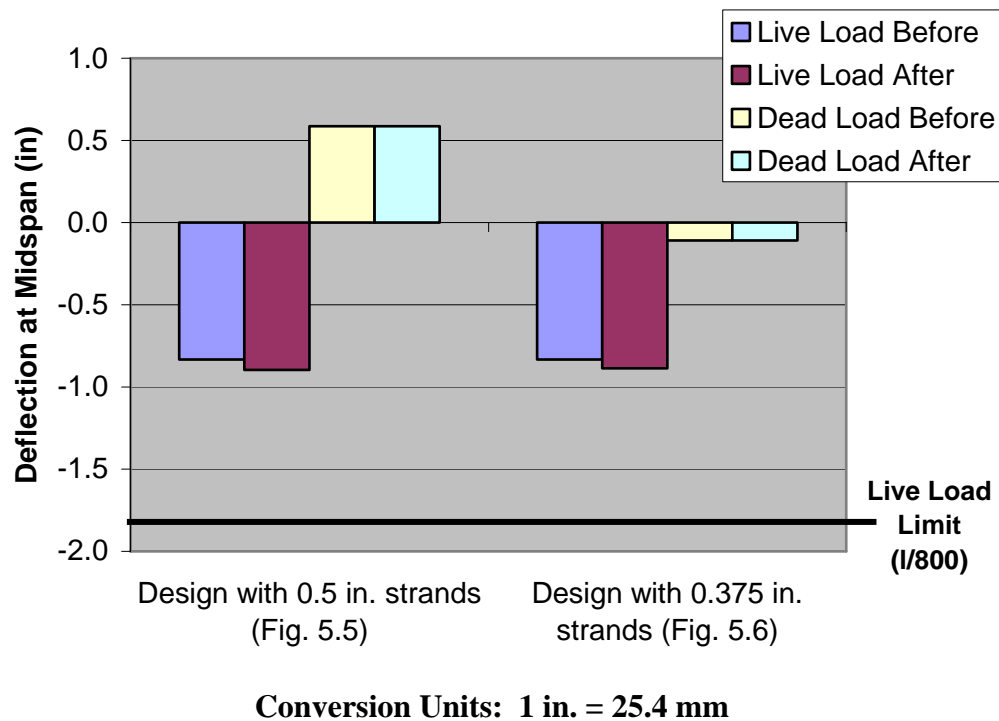


Figure 6.5 Deflection at midspan before and after the fire

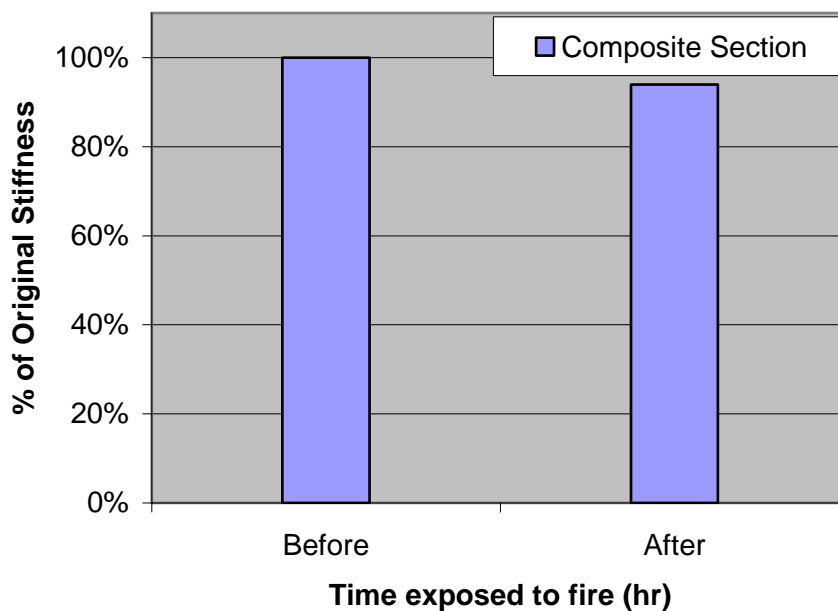


Figure 6.6 Stiffness of composite section before and after the fire

Based on the results for this study it would have been recommended that the negative moment sections be repaired and additional capacity restored before returning the bridge to service. Severe spalling and cracking along the deck will also need to be repaired in a timely manner.

### 6.3. PUYALLUP RIVER (TACOMA, WA)

**6.3.1. Accident.** In December of 2002, a fire occurred below a bridge which spanned the Puyallup River in Tacoma, Washington. The fire was caused by a railroad tanker carrying 30,000 gallons (113,600 liters) of methanol. The bridge spanned 147 ft. (44.8 m) and consisted of 15 girders spaced 5 ft. (1.5 m) on center. Due to the volume of chemical, the fire grew quickly and spread across the entire base of the bridge affecting all 15 girders. Investigators reported that the fire burned at an approximate peak temperature of 3000°F (1649°C) for 1 hour. Inspection showed no serious damage and the bridge was reopened the following day. Photos of during and after the fire can be seen in Figures 6.7 and 6.8.



**Figure 6.7 Fire located below bridge near Tacoma, Washington (Aspire, Spring 2008)**



**Figure 6.8** Damaged concrete located at the bottom of the girders (location which was closest to heat source) (Aspire, Spring 2008)

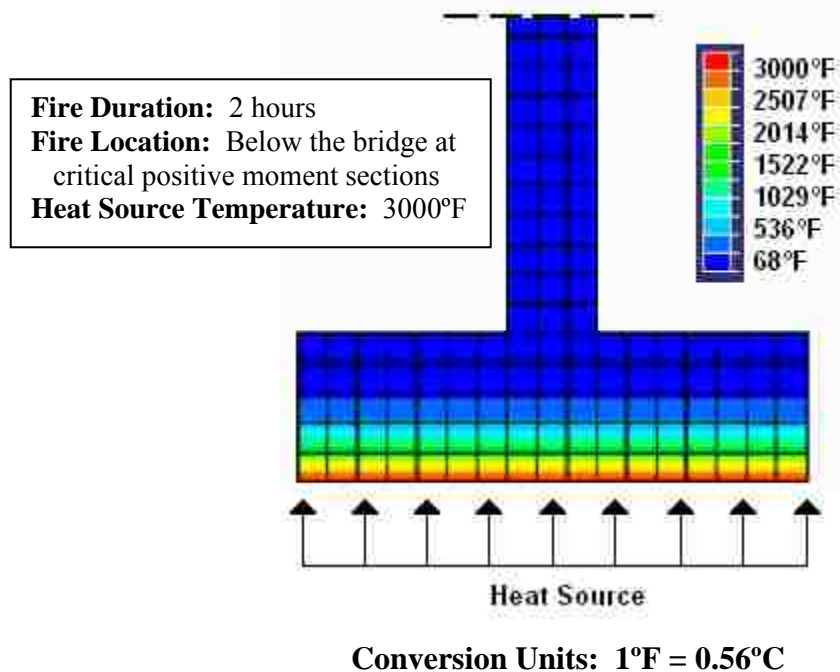
**6.3.2. Parametric Study.** For this particular fire, pool calculations are not valid because the fire occurred on objects below the bridge. Instead information used in the parametric study was obtained strictly from reports given by the Washington State Transportation Department. The temperature used in the study was 3000°F (1649°C), the approximate peak temperature reported by investigators. The actual burn duration that occurred is unclear, but the given information indicates it to be within 1-2 hours. For this case study both a 1 hour and 2 hour analysis were performed. This information was input into ABAQUS and then applied to the parametric study for fires below the bridge.

**6.3.3. Conclusions.** Based on the temperature profile output, the damaged compressive strength and moment of inertia of the concrete girder was determined. These values are reported in Table 6.2.

**Table 6.2** Fire damaged girder compressive strength and non-composite moment of inertia values before and after the fire

	Before	After 1 hour	After 2 hours
$f'_c$ (psi) (MPa)	7,000 (48.3)	5,020 (34.6)	4,400 (30.3)
$I_c$ (in <sup>4</sup> ) (m <sup>4</sup> )	527,217 (0.211)	411,881 (0.165)	386,902 (0.155)

The temperature profile output from ABAQUS for a burning duration for the most severe case of 2 hours is given in Figure 6.9. As previously noted, one element represents approximately 1.6 in. (40.6 mm) in height. The first layer of the prestressing steel for the 0.5 in. diameter strands is located at 2 in. (50.8 mm) from the bottom, which experiences a temperature of 1270°F (688°C). The second layer for that particular strand size is 4 in. (101.6 mm) from the bottom, at a temperature of 590°F (310°C). However, at a distance of 6 in. (152.5 mm), the location of the third layer, the temperature remains at the ambient level. Due to the short period of burning, the heat is unable to travel very deep into the girder and therefore only the first two layers of strands are damaged. For the 0.375 in. diameter girder, the rows of strands are spaced every 1.5 in. (38.1 mm) with the first row located 1.5 in. (38.1 mm) from the bottom of the girder. Therefore, these strands experienced higher temperatures than the other girder and are slightly more damaged than the 0.5 in. diameter strands.



**Figure 6.9** Temperature profile of bottom of girder after fire exposure of 2 hours (ABAQUS, 2007)



Using the temperatures output by the ABAQUS model, the moment capacities and deflections were calculated. As noted with the initial parametric study, a fire occurring below the bridge will cause the most severe damage to the structure at midspan. Therefore, to fully understand the severity of this particular fire this midspan location was chosen.

The moment section capacities of the bridge before and after the fire are given in Figures 6.10 and 6.11. For the girder with 0.5 in. diameter strands, adequate positive moment capacity is maintained throughout the 2 hour fire. The 0.375 in. diameter girder did not perform as well, failing to meet the “Required Factored Capacity” after 1 hour. The negative moment capacity for both girders was affected by the loss in compressive strength and stiffness of the concrete. Each experienced the same loss in capacity and failed the required factored limit after 1 hour. This limit failure is expected, because the undamaged capacity was only greater than the factored limit by 42 kip-ft (57 kN-m).

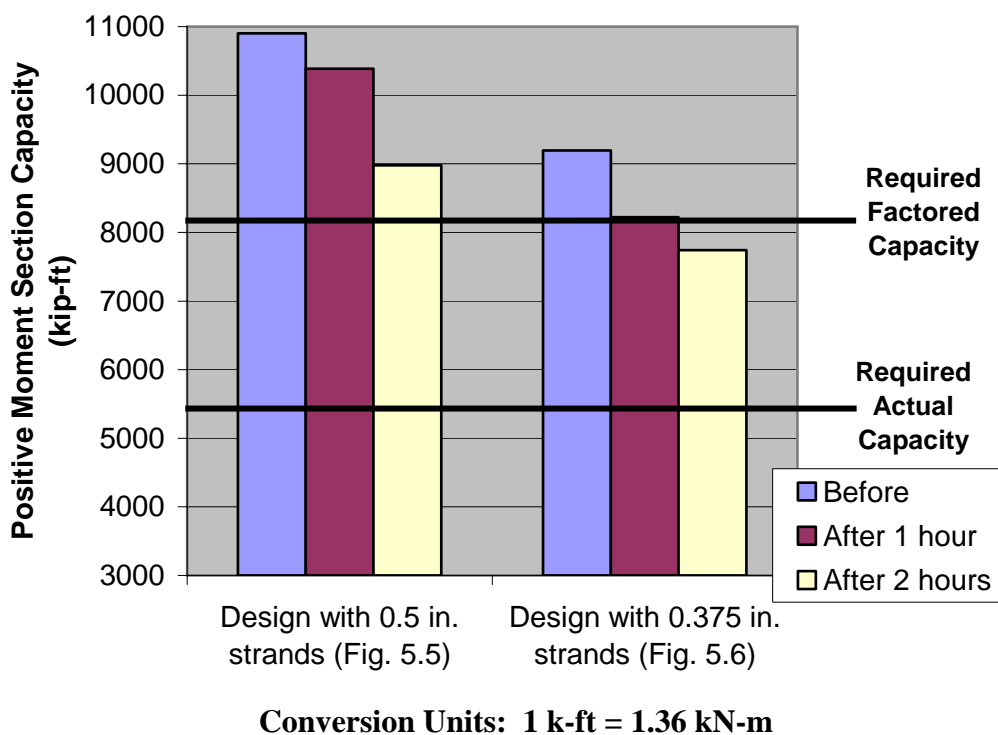
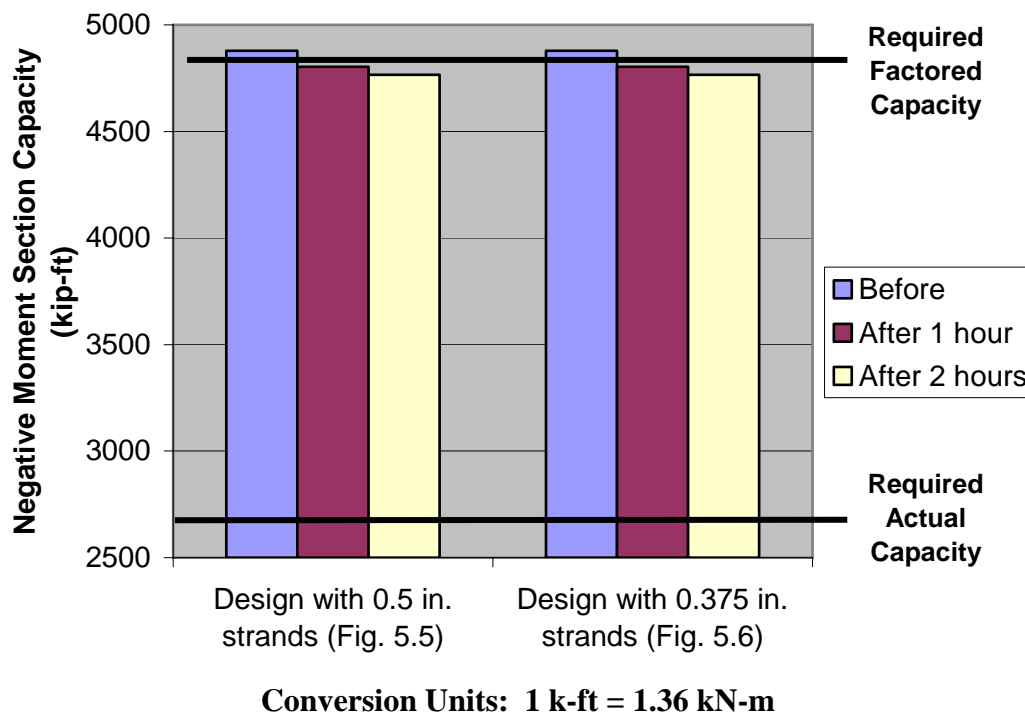


Figure 6.10 Positive moment section capacity before and after the fire



**Figure 6.11 Negative moment section capacity before and after the fire**

The deflection and stiffness for the bridge before and after the fire can be seen in Figures 6.12 and 6.13. A significant increase in self-weight deflection occurs due to the loss in stiffness and compressive strength of the concrete. Additional increase in deflection due to live load and impact also takes place.

For the stiffness a decrease of 89 percent of its original strength occurs after 1 hour and after 2 hours only 83 percent of its original strength is maintained. For this case study, the stiffness losses are slightly higher for the 1 hour exposure and almost exactly the same for the 2 hour exposure when compared to the standard fire discussed in Section 5.7.1. The standard fire examined experienced losses of 91 percent and 83 percent. As seen in the previous case study, the higher loss after 1 hour is due to the increase in temperature. However, as time progresses the values are more similar because it takes time for the heat to move through the concrete. Meanwhile the concrete near the heat source continues to become hotter until it is completely damaged.

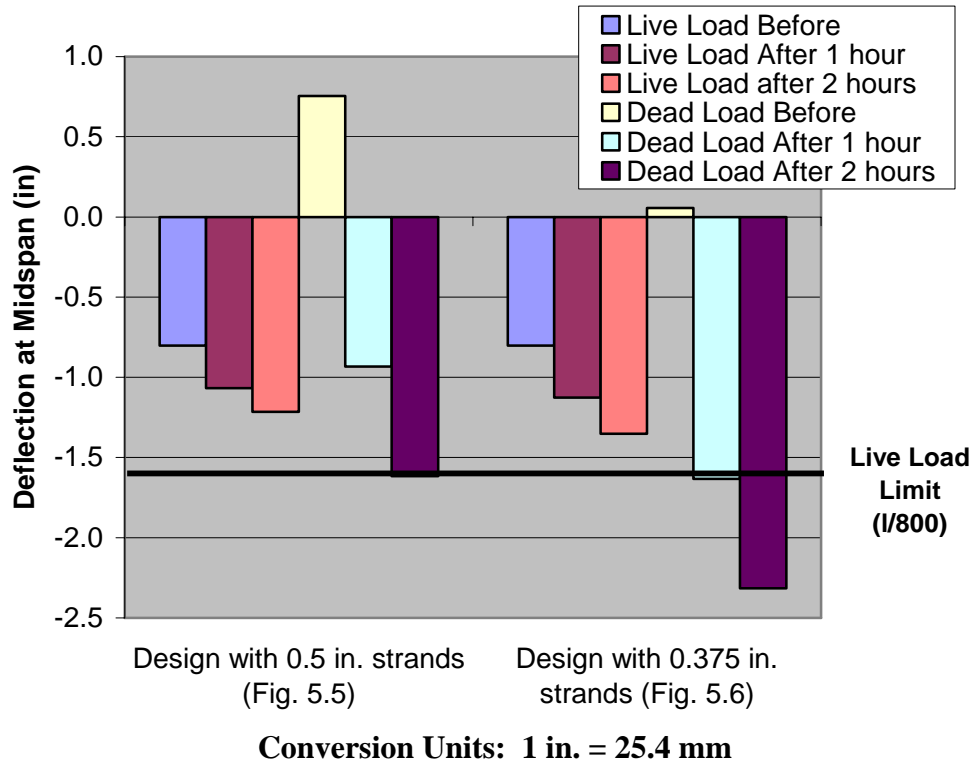


Figure 6.12 Deflection at midspan due to self-weight and live load before and after the fire

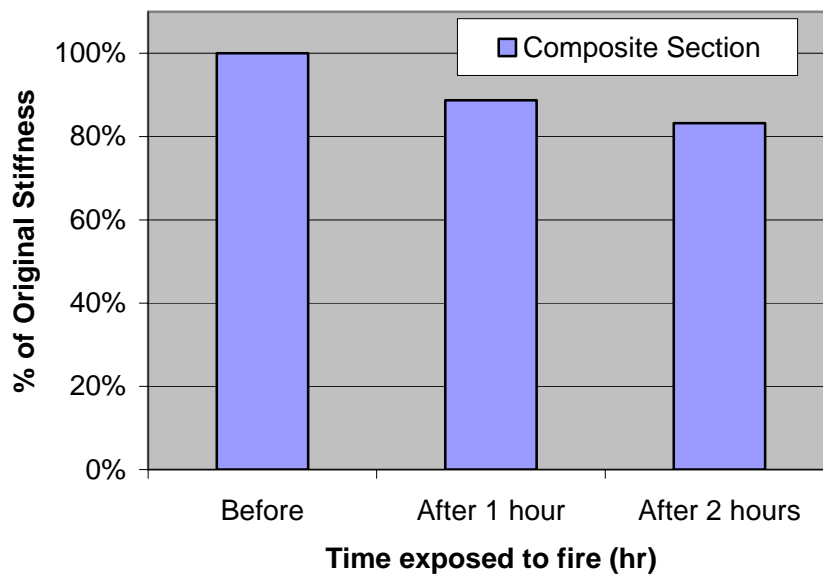


Figure 6.13 Stiffness of composite section before and after the fire

Based on the analyzed data, it is recommended that the bridge with 0.5 in. strands after exposure to either the 1 or 2 hour fire, be inspected and returned to service thereafter. For the bridge with 0.375 in. strands exposed to a 1 hour fire, the same recommendations apply. However, for an exposure of 2 hours the bridge should be repaired to increase the negative moment capacity before opening to the public.

#### 6.4. I-5 OVERPASS (LYNNWOOD, WA)

**6.4.1. Accident.** A fiery tractor trailer accident occurred on July 12, 2003 on an U.S. Interstate-5 overpass which passed over 44<sup>th</sup> Street in Lynnwood, Washington. The truck was traveling northbound carrying 11,300 gallons (42,800 liters) of unleaded gasoline. The overpass consisted of a prestressed concrete structure with asphalt deck overlay. Photos of the fire and burned tractor trailer can be seen in Figure 6.14.



**Figure 6.14 Bridge fire caused by a tractor trailer carrying gasoline which occurred on U.S. Interstate-5 near Lynnwood, Washington (Washington State Department of Transportation, 2003)**

Immediately after the accident, the northbound lanes of the interstate were closed for 18 hours while emergency responders and engineers cleared the area and inspected the bridge. Brief assessments during the initial hours after the fire found the deck to be

“structurally sound” but significant areas of spalling and crumbling of concrete were noted. Crews worked throughout the night to patch the damaged concrete and the overpass was reopened the next morning. Planned long term repairs included the replacement of the deck overlay and the concrete railing. However, based on inspection there was no damage to the other structural members.

**6.4.2. Parametric Study.** The maximum unconfined diameter calculated for this fire was 378 ft (115 m). Due to the limiting width of the bridge actual diameter was taken as 42 ft (12.8 m). Using the 42 ft (12.8 m), the burning duration was determined to be 1.25 hours. This value is similar to reports by the Washington DOT estimated the fire to have burned for approximately 1.5 hours. For the analysis, a time of 1.5 hours was used to be conservative.

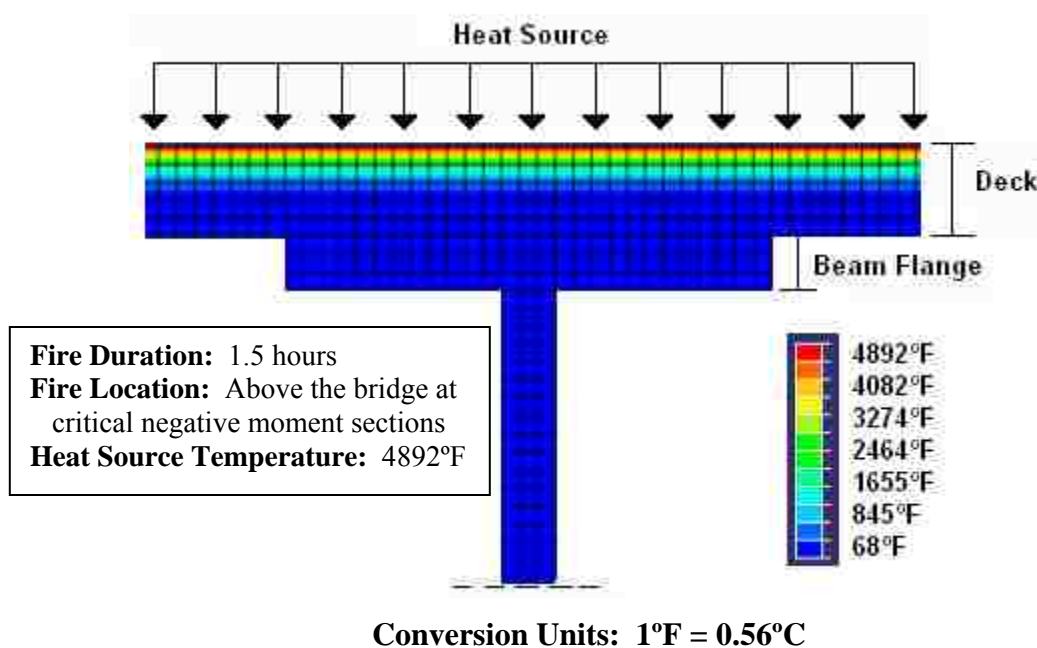
For this particular bridge fire there was no recorded information regarding the estimated flame temperature. Based on the information given in Section 2.6.2.1 it is clear that the temperature will be significantly higher than the reported average flame temperature for gasoline. Therefore an estimated temperature of 4892°F (2700°C) will be used for this study. This temperature was chosen due to the fire’s similarity to the Connecticut bridge fire and the increased volume.

**6.4.3. Conclusions.** The compressive strength and moment of inertia values for the undamaged and damaged bridge can be seen in Table 6.3. In addition, the temperature profile is shown in Figure 6.15. Both the damaged concrete properties and temperature profile for this particular fire are quite similar to the case study for the Connecticut Bridge. The difference is that the fire occurred over a longer period of time and therefore produced higher temperatures.

It is interesting to note that despite the increase in time and temperature the concrete deck remained the only damaged component of the structure. This observation is similar to those made by members of the Washington DOT who determined the deck to be the only damaged structural component of the bridge.

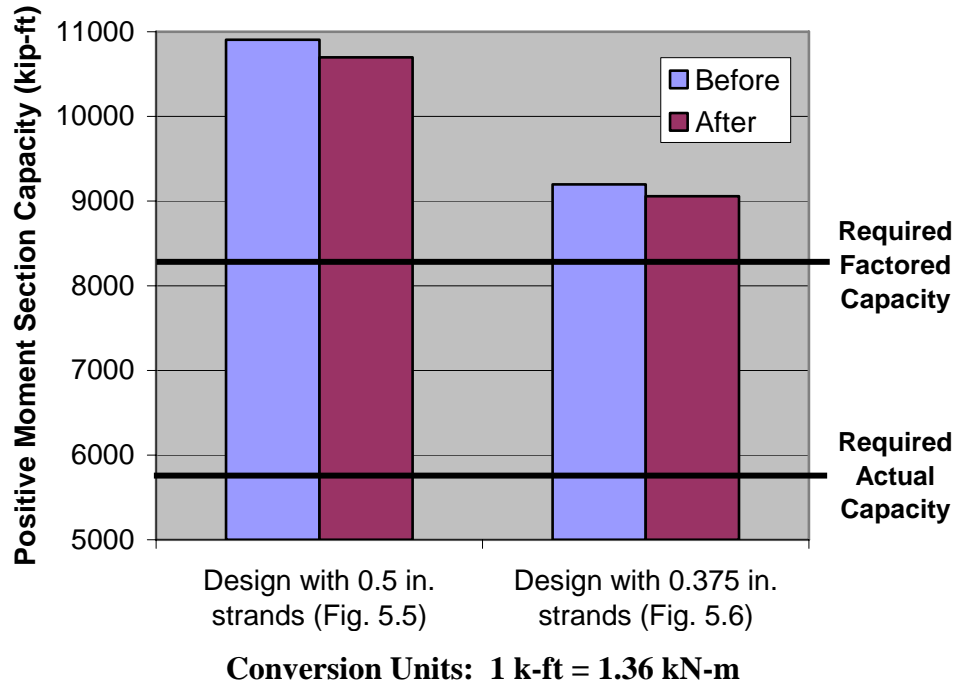
**Table 6.3 Fire damaged deck compressive strength and composite moment of inertia values before and after the fire**

	Before	After
$f_c$ (psi) (MPa)	4,000 (27.6)	2,950 (20.3)
$I_c$ (in <sup>4</sup> ) (m <sup>4</sup> )	1,091,316 (0.437)	1,018,528 (0.407)

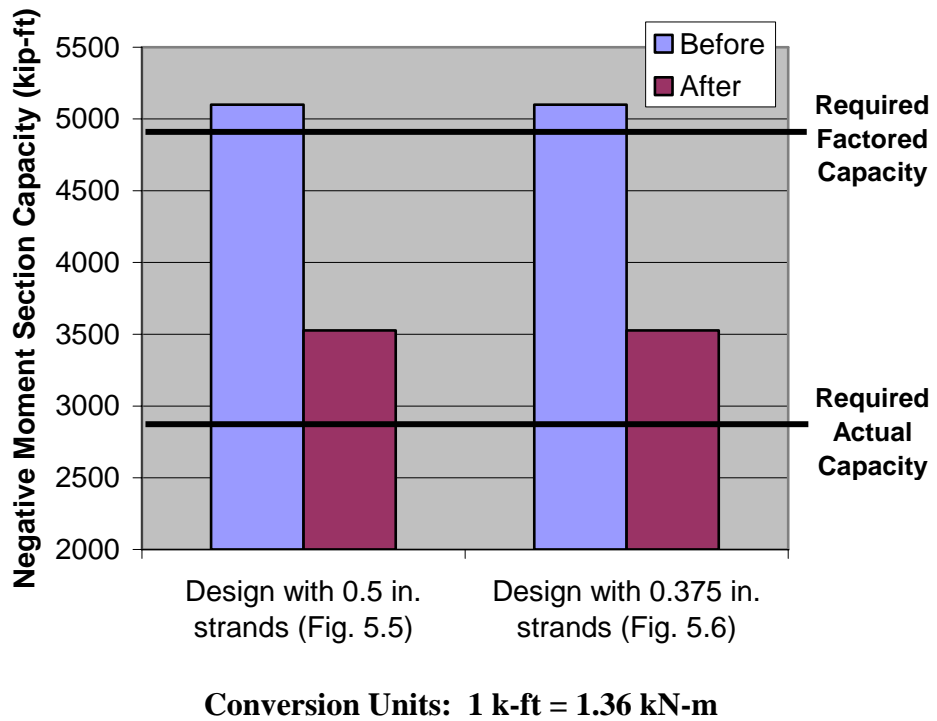


**Figure 6.15 Temperature profile for fire on bridge deck (ABAQUS, 2007)**

The positive moment section capacity is shown in Figure 6.16. As seen in prior examples both the girder with the 0.5 in. strands and the girder with the 0.375 in. strands maintained adequate positive flexural capacity. However, due to the fire occurring on the deck the negative moment capacity (shown in Figure 6.17) was severely compromised. This loss in capacity is significantly higher than the losses seen in the Connecticut case study.

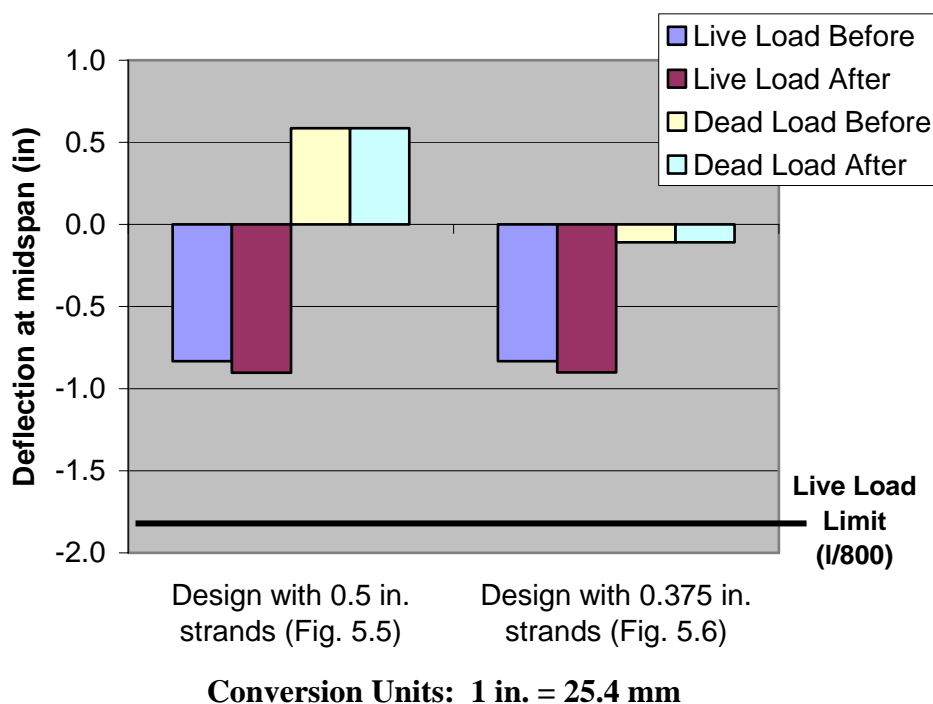


**Figure 6.16 Positive moment section capacity before and after fire**



**Figure 6.17 Negative moment section capacity before and after the fire**

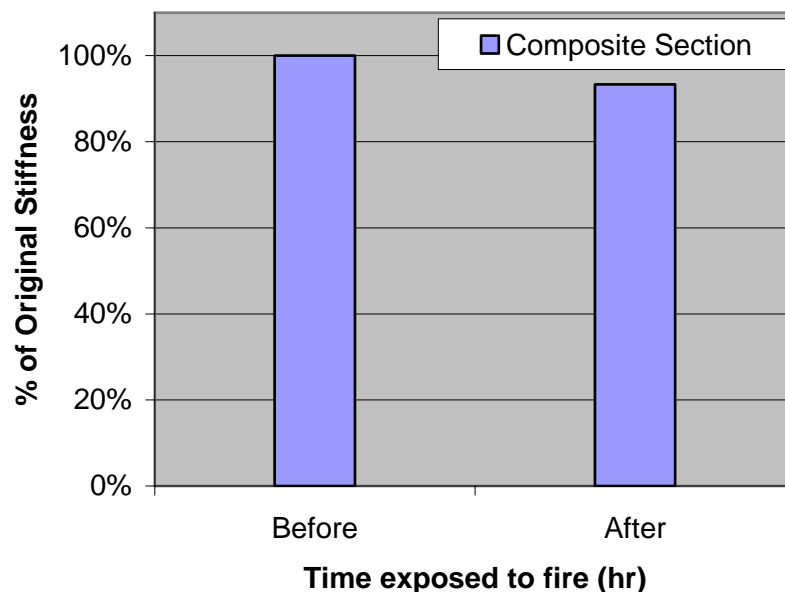
The results for deflection are given in Figure 6.18. As before, the deflection was not severely affected by the fire, because the girders which carry the bridge loads were not damaged by the fire. A slight increase in deflection did occur which was due to the decrease in stiffness and strength of the concrete.



**Figure 6.18 Deflection at midspan due to self-weight and live load before and after the fire**

Stiffness losses for this case study are presented in Figure 6.19. As anticipated the stiffness loss was slightly greater (1 percent) than the loss which occurred in the Connecticut bridge fire. This is due to the increase in temperature and fire duration. However, in general these losses are not substantial and would not likely result in failure.





**Figure 6.19 Stiffness of composite section before and after the fire**

Given the results shown, it is recommended that the bridge remain closed until repairs can be made to the negative moment section regions. The overall deck will need repairs due to spalling and cracking. The replacement of the deck is one way in which the negative moment section capacity may be easily restored.

## 6.5. CASE STUDY DISCUSSION

Based on the results from all three case studies, it appears that overall the bridges performed fairly well despite high temperature exposure. The short period of time at which these temperatures were applied and the thermal properties of concrete prevented heat from traveling deep into the structure.

For all three case studies, the “Required Actual Section Capacity” was adequate. As noted earlier, this value is highly unconservative and should not be used as a design value. However, for reference purposes it can be noted that the capacities are within the multiplier range.

An important factor to note is that ACI 318-05 allows for up to 20 percent redistribution of the negative moment. If this were to be applied to the case studies, the bridge near Ridgefield, Connecticut and the bridge near Tacoma, Washington would

exceed the required factored capacity. This would also deem these bridges adequate and acceptable to be used by the public.

In addition to the loss in capacity and stiffness and increase in deflection, the bond between the concrete and steel exposed to high temperatures would also be reduced. As shown in Section 4, the bond is significantly reduced after exposure to temperatures of 500°F (260°C) or greater. However, for these particular case studies only a few layers of strands would be affected. The majority of the steel reinforcing located deeper into the member would retain the bond characteristics of a non-fire damaged strand after the fire.

As explained in Section 6.1, these case studies were developed by taking actual fire damaged bridge data and applying it to the PCI Bridge Design example. For this example, the undamaged negative moment section capacity was only 42 kip-ft (57 kN-m) greater than the “Required Factored Capacity”. Had this value been slightly higher the bridge would have met the negative section capacity requirements for the first two case studies. Likewise, had the positive moment section capacity been smaller, failure of that criterion may have occurred. In addition, if the girder with 0.375 in. strands was designed with the same amount of capacity as the girder with 0.5 in. strands, it too would have behaved in the same manner as the 0.5 in. girder. Therefore, given a different design this bridge may or may not have met the capacities and deflections in the same manner.

However, this analysis helps to understand the extent at which fires cause damage. The implications caused by a bridge fire can be quite expensive and time-consuming. Based on this information, engineers and inspectors will be able to make a more rapid evaluation regarding the fate of a bridge following fire.

## 7. CONCLUSIONS AND RECOMMENDATIONS

### 7.1. GENERAL

The experimental program consisted of laboratory testing of fire damaged prestressing strands in tension and concrete-steel pullout specimens. The data obtained was then applied to a parametric study which examined the moment section capacity loss, deflection increase and stiffness loss caused by a fire for the standard time-temperature curve and three case studies of actual bridge fires.

### 7.2. FIRE DAMAGED PRESTRESSING STEEL PROPERTIES

Prestressing strand properties were evaluated after exposure to temperatures ranging between 68°F (20°C) to 1300°F (704°C) and then cooled either inside or outside the furnace. Exposure time periods analyzed included 35 minutes and 60 minutes of soak time in the furnace. Properties were determined by tension testing of the strands. Based on the experimental data, the following conclusions can be drawn:

1. There is significant loss in prestressing strand tensile strength upon exposure to elevated temperatures greater than 500°F (260°C). This significant loss for the increment of 500°F-800°F (260°C-427°C) is 9.6 percent and increases to 21.5 and 26.0 percent for respective temperatures increments between 800°F-1000°F (427°C-538°C) and 1000°F-1200°F (538°C-649°C). The final temperature range, 1200°F-1300°F (649°C-704°C), which is the smallest increment, experienced a tensile strength loss of 4.8 percent. A minimal tensile strength loss of 2.3 percent occurred at the initial temperature increment of 68°F-500°F (20°C-260°C).
2. The duration of exposure to elevated temperatures is critical in the residual tensile strength after cooling. Strands soaked at a temperature for 35 minutes performed better than those soaked for 60 minutes. A significant difference in performance of 6-25 percent was found for temperatures 1000°F-1300°F (538°C-704°C).
3. Regardless of the cooling method employed the prestressing strands behaved similarly, as first noted by Abrams and Cruz (1961).
4. The non-linear behavior of the prestressing steel is significantly affected upon reaching the critical temperature range of 800°F-1000°F (427°C-538°C). Within

these temperatures the steel becomes brittle, yielding at fracture or fracturing before yielding depending on the temperature exposure.

### 7.3. FIRE DAMAGED BOND PERFORMANCE

The bond performance of the prestressing strand and concrete was assessed by performing pullout testing on two different high-strength concrete mix designs. The specimens were heated to temperatures of 68°F (20°C) to 1300°F (704°C) and then tested upon cooling. The following conclusions were made based on the experimental data obtained.

1. The failure of the pullout specimen was dependent on the heat induced cracking experienced prior to testing. Based on observations the bond stress was higher for specimens with fewer cracks.
2. Density of heat cracking was higher for the 11 ksi compressive strength specimens than the 14 ksi compressive strength specimens. This contributes to data published by Guise (1996) for heat crack density of concrete compressive strengths between 6.3 ksi and 8.3 ksi (43.6 MPa and 56.9 MPa).
3. The bond stress of high-strength concrete decreases significantly with exposure to temperature. Beginning at 500°F (260°C) the average percent of original bond stress is 90 percent for 14 ksi specimens and 80 percent for 11 ksi specimens. Upon further increase in temperature it continues to lose strength at a steeper drop.
4. The 14 ksi strength concrete forms a stronger bond with the prestressing strand compared to the 11 ksi strength concrete. Bond stresses for both strand sizes of the 14 ksi strength concrete were greater than that of the 11 ksi strength concrete. However, the 14 ksi strength concrete produced a brittle failure at lower temperatures, whereas the 11 ksi strength concrete continually produced a ductile failure.
5. In addition to the mix design, the size of the strand also affects the bond stress. The test results show that the smaller diameter, 0.375 in., performed better for both concrete mixes compared to the 0.5 in. strand. This confirms reports noted by Hanson and Karr (1959), Lane (1992) and Martin and Scott (1976).

6. Despite bond behavior after temperature exposure the majority of the test results for the high strength concrete met current code requirements specified by ACI, AASHTO and FHWA. The only strand to not meet the specification was the 0.5 in.-11 ksi strand heated to temperatures 1000°F-1300°F (538°C-704°C).

#### **7.4. FIRE DAMAGED BRIDGE PERFORMANCE**

Based on an extensive parametric study for the ASTM standard time-temperature curve and actual case study information, the following conclusions have been developed.

1. A fire that occurs below the bridge will have the most devastating affect on the positive moment section at midspan. This is due to the majority of the prestressing steel being located in the bottom of the girder and the small concrete cover between the heat source and the prestressing steel.
2. Fire occurring on an 8 in. (20.32 cm) thick bridge deck at temperatures of 4892°F (2700°C) or less will not penetrate the entire deck within 4 hours. Severe damage will be incurred by the deck which, depending on the design and location of the fire, may cause significant loss in negative moment capacity. However, the overall deflection and positive moment capacity will be affected minimally.
3. In the case of a typical standard fire for a bridge with a similar design to the discussed PCI Design example, the bridge will survive a fire below the bridge that burns for 2 hours or less and a fire above the bridge that burns for 3 hours or less.
4. For a typical hydrocarbon fire with a bridge design similar to the discussed PCI Design example, the bridge will survive a fire burn duration below the bridge of at least 1 hour and above the bridge of at least 1.5 hours.

#### **7.5. FUTURE RECOMMENDATIONS**

Based on the experimental program and test data obtained, several recommendations have been developed.

1. In this study the temperature was limited by the furnace's capabilities. Additional research should include an increase in the spread of data which includes temperatures greater than 1600°F (871°C). This would provide information

regarding the effects of ultra-high temperature exposure which typically occurs with hydrocarbon fuel fires.

2. The information presented by the parametric study is beneficial, but should be validated by physical testing of an actual bridge with a known level of fire damaged properties. This larger scale testing may include girders, slabs, and or a prestressed concrete bridge.
3. In addition to increasing the scale of the study, special testing should be performed for hydrocarbon fires which are commonly the cause of bridge fires. This would include hotter temperatures held for various periods of time.
4. During the extensive literature review prepared for this thesis, no information regarding fire damage shear behavior of members was found. This topic is very important and should be investigated.
5. It was assumed that the internal temperature was uniform within the concrete pullout specimens after 60 minutes. Further testing should be performed where this internal temperature is constantly monitored by thermocouples.

## APPENDIX

### 1. INTRODUCTION

Included with this thesis is a CD-ROM, which contains the PCI Design Example spreadsheet calculations for the parametric studies of the standard fire and case studies. The calculations are based on Section 9.6 of the PCI Bridge Design Manual (1997). The included files are in Adobe Acrobat format (pdf) and are outlined below.

### 2. CONTENTS

1. Parametric Study for a Fire Below the Bridge at the Critical Positive Moment Section at Midspan
2. Parametric Study for a Fire Above the Bridge at Critical Negative Moment Sections
3. Parametric Study for a Fire Above the Bridge Between Girders
4. Parametric Study for a Case Study of U.S. Route 7 Bridge (Ridgefield, CT)
5. Parametric Study for a Case Study of Puyallup River (Tacoma, WA)
6. Parametric Study for a Case Study of Interstate-5 (Lynnwood, WA)

## BIBLIOGRAPHY

- Abrams, M.S. "Compressive Strength of Concrete at Temperatures to 1600°F,"  
Temperature and Concrete: SP-25. Published by the American Concrete Institute,  
Detroit, MI. 1968, pp. 33-41.
- Abrams, M.S., Cruz, C.R. "Behavior of High Temperatures of Steel Strand for  
Prestressed Concrete," Journal of the PCA Research, V. 3, No. 3, Sept. 1961, pp.  
8-19.
- Abrams, M.S., Erlin, B. "Estimating Post-Fire Strength and Exposure Temperature of  
Prestressing Steel by Metallographic Method," Journal of the PCA Research, V.  
9, No. 3, Sept. 1967, pp. 23-33.
- Abrams, M.S., Gustaferro, A.H. "Fire Endurance of Concrete Slabs as Influenced by  
Thickness, Aggregate Type, and Moisture," Journal of the PCA Research and  
Development Laboratories, V.10, No. 2, 1968, pp. 9-24.
- ACI 318-05: Building Code Requirements for Structural Concrete," Published by the  
American Concrete Institute, Farmington Hills, MI.
- ACI Committee 408R-03: Bond and Development of Straight Reinforcing Bars in  
Tension," Published by the American Concrete Institute, Farmington Hills, MI.
- Alnahhal, W.I., Chiewanichakorn, M., Aref, A.J., Alampalli, S. "Temporal Thermal  
Behavior and Damage Simulations of FRP Deck," Journal of Bridge Engineering,  
July-Aug. 2006.
- American Association of State Highway and Transportation Officials (AASHTO).  
AASHTO LRFD Bridge Design Specifications. 2nd ed. Washington, D.C.: 1998.
- American Society for Testing and Materials International (ASTM A 370 – 07a).  
Standard Test Methods and Definitions for Mechanical Testing of Steel Products,  
American Society for Testing and Materials, West Conshohocken, PA, 2002.
- American Society for Testing and Materials International (ASTM A 416/A 416 – 06).  
Standard Specification for Steel Strand, Uncoated Seven-Wire for Prestressed  
Concrete, American Society for Testing and Materials, West Conshohocken, PA,  
2002.
- Anderson, W. R. (1964). "Steel for Prestressed Concrete." PCI Journal, V. 9, No. 2, pp.  
109-117.



- Chakrabarti, S.C., Sharma, K.N., Mittal, A. "Residual Strength in Concrete after Exposure to Elevated Temperature," *The Indian Concrete Journal*. Dec. 1994, pp. 713-717.
- Chan, S., Peng, G., Chan, J. "Comparison Between High Strength and Concrete and Normal Strength Concrete Subjected to High Temperature," *Materials and Structures*, V. 29, No. 10, Dec. 1996, pp. 616-619.
- Chiang, C.H., Tsai, C.L., Kan, Y.C. "Acoustic Inspection of Bond Strength of Steel-Reinforced Mortar After Exposure to Elevated Temperatures," *Ultrasonics*, V. 38, 2000, pp. 534-536.
- Chang, Y.F., Chen, Y.H., Sheu, M.S., Yao, G.C., "Residual stress-strain relationship for concrete after exposure to high temperatures," *Cement and Concrete Research*, V. 36, No. 10, Oct. 2006, pp. 1999-2005.
- Chao, S.H. 2005. Bond Characterization of Reinforcing Bars and Prestressing Strands in High Performance Fiber Reinforced Cementations Composites under Monotonic and Cyclic Loading," Ph.D. Dissertation, University of Michigan, Ann Arbor.
- Collins, M.P., Mitchell, D. *Prestressed Concrete Structures*. Ed. Response Publications Toronto & Montreal, Canada, 1997.
- Dias, W.P.S. "Some Properties of Hardened Cement Paste and Reinforcing Bars upon Cooling from Elevated Temperatures," *Fire and Materials*, V.16, No. 1, 1992, pp. 29-35.
- Division of Engineering Brown University. ABAQUS tutorial. 30 June 2008.  
<<http://www.engin.brown.edu/courses/en175/abaquistut/abaquistut.htm>>
- Edwards, W.T., Gamble, W.L., "Strength of Grade 60 Reinforcing Bars After Exposure to Fire Temperatures," *Concrete International: Design & Construction*, V. 8, No. 10, Oct. 1986, pp. 17-19.
- Ferguson, P., Turpin, R., Thompson, J., "Minimum Bar Spacing as a Function of Bond and Shear Strength," *ACI Journal, Proceedings*, V. 50, No. 10, June 1954, pp. 869-888.
- Georgali, B., Tsakiridis, P.E. "Microstructure of Fire-Damaged Concrete. A Case Study," *Cement and Concrete Composites*, V. 27, No. 2, Feb. 2005, pp. 255-259.
- Gosselin, Guy C. "Structural Fire Protection – Predictive Methods," *Building Science Insight 1987: Designing for Fire Safety*, Canada, 1987.

- Graybeal, Benjamin A. "Flexural Capacity of Fire-Damaged Prestressed Concrete Box Beams," Federal Highway Administration, U.S. Department of Transportation, McLean, Virginia, February 2007.
- Guise, S.E., Short, N.R., Purkiss, J.A. "Petrographic and Colour Analysis for Assessment of Fire Damaged Concrete," Proceedings of the International Conference on Cement Microscopy, April 1996, pp. 365-372.
- Gustaferro, A.H., Martin, L.D. Design for Fire Resistance of Precast Prestressed Concrete. Chicago, Ill., Prestressed Concrete Institute, 1989.
- Guyon, Y. Prestressed Concrete. London: F.J. Parsons, Limited of London, Folkestone and Hastings, 1953.
- Hanson, N.W, Karr, P.H., "Flexural Bond Tests of Pretensioned Prestressed Beams," ACI Journal, Proceedings, V. 55, No. 7, Jan. 1959, pp. 783-802.
- Harada, T., Takeda, J., Yamane, S., Furumura, F. "Strength, Elasticity and Thermal Properties of Concrete Subjected to Elevated Temperatures," Concrete for Nuclear Reactors: SP-34. Published by the American Concrete Institute, Detroit, MI. 1972, pp. 377-406.
- Hertz, K.D. "Reinforcement Data for Fire Safety Design," Magazine of Concrete Research, V. 56, No. 8, 2004, pp. 456-459.
- Hertz, K.D. "Residual Properties of Concrete Heated Rapidly." Evaluation and Repair of Fire Damage to Concrete, SP 92," American Concrete Institute, Detroit, Michigan, 1986.
- Holmes, M., Anchor, R.D., Cook, G.M.E., Crook, R.N. "The Effect of Elevated Temperatures on the Strength Properties of Reinforcing and Prestressing Steels," The Structural Engineer, V. 60B, No. 1, Mar. 1982, pp. 7-13.
- Hyatt, T. "An account of some experiments with Portland-cement-concrete combined with iron, as a building material, with reference to economy of metal in construction, and for security against fire in the making of roofs, floors and walking surfaces," Chiswick Press, London 1877, 45 pp.
- Ingason, H. "Two Dimensional Rack Storage Fires," Proceedings of the Fourth International Symposium Fire Safety Science, 1994, pp.1209-1220.
- Iqbal, N., Salley, M.H., "Estimating Burning Characteristics of Liquid Pool Fire, Heat Release Rate, Burning Duration, and Flame Height," Fire Dynamics Tools (FDTs) Quantitative Fire Hazard Analysis Methods for the U.S. Nuclear Regulatory Commission Fire Protection Inspection Program (NUREG-1805, Final Report), Chapter 3, December 2004, pp. 1-21.

- Kumar, A., Kumar, V., "Behaviour of RCC Beams after Exposure to Elevated Temperatures," IE (I) Journal – CV, V. 84, November 2003, pp. 165-170.
- Lane, S., "A New Development Length Equation for Pretensioned Strands in Bridge Beams and Piles," Publication No. FHWA-RD-98-116, Federal Highway Administration, U.S. Department of Transportation, McLean, Virginia, February 2007.
- Lane, S.N. "Transfer Lengths in Rectangular Prestressed concrete Concentric Specimens," Public Roads, V. 56, No. 2, Sept. 1992, pp. 67-71.
- LeClaire, P.J. 1991. "The Effect of Temperature on the Bond Strength of Epoxy-Coated Prestressing Strand," Masters of Science Thesis, Department of Civil Engineering, University of Wisconsin-Milwaukee, Milwaukee.
- Luo, X. Sun, W., Chan, Y.N. "Residual Compressive Strength and Microstructure of High Performance Concrete After Exposure to High Temperature," Materials and Structures, V. 33, No. 5, June 2000, pp. 294-298.
- Mace, Tony. Personal Interview. 9 April 2008.
- MacLean, K. 2007. "Post-Fire Assessment of Unbonded Post-Tensioned Concrete Slabs: Strand Deterioration and Prestress Loss." Masters of Science Thesis, Department of Civil Engineering, Queen's University, Kingston, Ontario, Canada.
- Malhotra, H.L. "The Effect of Temperature on the Compressive Strength of Concrete," Magazine of Concrete Research, V. 7, No. 23, Aug. 1956, pp. 85-94.
- Martin, L.D., Scott, N.L. "Development of Prestressing Strands in Pretensioned Members," ACI Journal, Proceedings, V. 73, No. 8 Aug. 1976, pp. 453-456.
- McGannon, H.E. ed. The Making, Shaping and Treating of Steel. 9th ed. Pittsburg: United States Steel, 1971.
- Mohamedbhai, G.T.G., "The Residual Strength of Concrete Subjected to Elevated Temperatures," Concrete, Dec. 1983, pp. 22-27.
- Mudan, K. S., Croce, P. A., "Fire Hazard Calculations for Large Open Hydrocarbon Fires," SFPE Handbook of Fire Protection Engineering, P.J. DiNenno, Ed. Quincy, MA: The National Fire Protection Association Press, 1995, Chapter 3-11, p. 197-215.
- Nassif, A.Y., Burley, E., Rigden, S. "A New Quantitative Method of Assessing Fire Damage to Concrete Structures," Magazine of Concrete Research, V. 47, 1995, pp. 271-278.

- Nawy, Edward G. *Prestressed Concrete: A Fundamental Approach*. 5th ed. Saddle River, NJ: Pearson Prentice Hall, 2006.
- Neves, I.C., Rodrigues, J.P., Loureiro, A. "Mechanical Properties of Reinforcing and Prestressing Steels After Heating," *Journal of Materials in Civil Engineering*, Nov. 1996, pp. 189-194.
- Noumowe, A.N., Clastres, P. Debicki, G. "High Performance Concrete for Severe Thermal Conditions," *Proceedings of the International Conference on Concrete under Severe Conditions, CONSEC '95*, Sapporo, Japan, Aug. 1995.
- Ongah, R., Mendis, P., Sanjayan, J., "Performance of Normal and High-Strength Reinforced Concrete Walls I Fire," *Proceedings of International conference on Advances in Structures (ASSCCA '03)*, Sydney, June 2003, pp. 643-649.
- Papayianni, J. Vallasis, T. "Residual Mechanical Properties of Heated Concrete Incorporating Different Pozzolanic Materials," *Materials and Structures*, V. 24, No. 4, Mar. 1991, pp. 115-121.
- Phan, Long T., Carino, Nicholas J., "Fire Performance of High Strength Concrete: Research Needs," *Proceedings ASCE/SEI Structures Congress 2000, Building and Fire Research Laboratory, National Institute of Standards and Technology*, 2000
- Precast/Prestressed Concrete Institute (PCI). *Precast Prestressed Concrete Bridge Design Manual*. 1st ed. 1997.
- Precast/Prestressed Concrete Institute (PCI). *PCI Design Handbook*. 6th ed. 2004.
- Precast/Prestressed Concrete Institute. "Guidelines for the Use of Epoxy-Coated Strands," *PCI Journal*, V.38, No. 4, 1993, pp.26-32.
- Qian, C., Saito, K., "Measurements of Pool-Fire Temperature Using IR Technique," *Proceedings of Combustion Fundamentals and Applications*, San Antonio, TX, April 1995, pp. 81-86.
- Russell, B., Burns, N., "Measured Transfer Lengths of 0.5 and 0.6 in. Strands in Pretensioned Concrete," *PCI Journal*, V. 41, No. 5, Sept.-Oct. 1996, pp. 44-65.
- Shutt, C.A. "Protecting Against Fire," *ASPIRE: The Concrete Bridge Magazine*, Spring 2008, pp. 18-22.
- Simulia. (2007). *ABAQUS/Standard User's Manual Version 6.7* Simulia., Providence, R.I.

- Steinberg, E. Lubbers, A. "Bond of Prestressing Strands in UHPC," Proceedings of the PCI/FHWA International Symposium on High performance Concrete, Orlando, FL, Oct. 2003, pp. 1-15.
- Stoddard, R.B. "Evaluating Fire Damage," ASPIRE: The Concrete Bridge Magazine, Spring 2008, pp. 24-27.
- Wang, Z. Tan, K. "Residual Area Method for Heat Transfer Analysis of Concrete-Encased I-Sections in Fire," Engineering Structures, V.28, 2006, pp. 411-422.
- Washington State Department of Transportation, "WSDOT Weekly Report-Special Edition," 22 July 2003.
- Washer, G.A., "Performance of Epoxy-Coated Prestressing Strands at Elevated Temperatures," Public Roads, V. 59, No. 1, Summer 1995.
- Weigler, H. Fischer, R. "Influence of High Temperatures on Strength and Deformation of Concrete," Concrete for Nuclear Reactors: SP-34. Published by the American Concrete Institute, Detroit, MI. 1972, pp. 481-491.
- Wickstrom, U. "A Very Simple Method for Estimating Temperature in Fire Exposed Concrete Structures," Technical Report SP-RAPP 1986:45, Swedish National Testing Institute, 1986.
- Yang, Sarah. "T.Y. Lin, World Renowned Structural Engineer, Dies at Age 91." UC Berkeley News 18 Nov. 2003.
- Zalosh, Robert G. Industrial Fire Protection Engineering. West Sussex: John Wiley & Sons Ltd., 2003.
- Zoldners, N.G. "Effect of High Temperatures on Concretes Incorporating Different Aggregates," American Society for Testing Materials Proceedings, V. 60, 1960, pp. 1087-1108.

## VITA

Wendy LeAnn Moore was born on September 20, 1984 in Burlington, Colorado. She completed her secondary education in Wellsville, Kansas where she graduated from Wellsville Senior High School in May 2003 as valedictorian of her class.

Following high school, she attended the University of Missouri-Rolla (now Missouri University of Science and Technology). As an undergraduate student, she was a member of the women's varsity cross country and track teams, Blue Key National Honor Society, Chi Epsilon, Student Athletic Advisory Committee, Missouri Miner Newspaper Staff, Phi Kappa Phi and Fellowship of Christian Athletes. Wendy graduated Magna Cum Laude with a Bachelor's of Science in Architectural Engineering in May 2007.

After her undergraduate studies, Wendy continued her education at Missouri University of Science and Technology attaining a Master's of Science in Civil Engineering with an emphasis in structural engineering in December 2008.



**Location: Fire at Critical Positive Moment Sections**  
**Beam Design: 1/2" Strand**  
**Fire Exposure Status: Undamaged**

(PCI Bridge Design Manual Section 9.6)

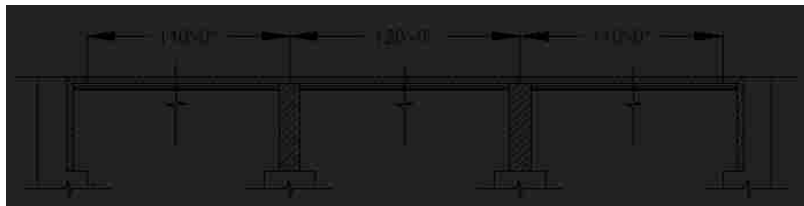


**Material Properties**

CAST-IN-PLACE SLAB			
Actual Thickness	$t_{as} =$		8.0 in
Wearing Surface	$=$		0.5 in
Structural thickness = Actual - Wearing Surface	$t_s =$		7.5 in
Compressive Strength	$f'_c =$		4 ksi
Unit Weight	$w_c =$		150.0 pcf
Stress factor of compression block	$\beta_1 =$		0.85

BEAMS: AASHTO-PCI, BT-72 BULB-TEE			
Strength at release	$f_{ci} =$		5.5 ksi
Strength at 28 days	$f'_c =$		7 ksi
Unit Weight	$w_c =$		150.0 pcf
Overall Beam Length:			
@ end spans	$L =$		110 ft
@ center span	$L =$		119 ft
Design Spans:			
Non-composite beam @ end spans	$L =$		109 ft
Non-composite beam @ center span	$L =$		118 ft
Composite beam @ end spans	$L =$		110 ft
Composite beam @ center span	$L =$		120 ft
Beam Spacing	$S =$		12 ft





**PRESTRESSING STRANDS**

Diameter of single strand	d =	0.5 in
Area of single strand	A =	0.153 in <sup>2</sup>

Temperature of Layer

layer 1 (bottom)	T =	68.00 °F
layer 2	T =	68.00 °F
layer 3	T =	68.00 °F
layer 4	T =	68.00 °F
layer 5	T =	68.00 °F
layer 6	T =	68.00 °F
layer 7	T =	68.00 °F
layer 8	T =	68.00 °F
layer 9	T =	68.00 °F
layer 10	T =	68.00 °F
layer 11	T =	68.00 °F
layer 12	T =	68.00 °F
layer 13	T =	68.00 °F
layer 14	T =	68.00 °F

Ultimate Strength

initial = 277 ksi

layer 1 (bottom)	f <sub>pu</sub> =	277 ksi
layer 2	f <sub>pu</sub> =	277 ksi
layer 3	f <sub>pu</sub> =	277 ksi
layer 4	f <sub>pu</sub> =	277 ksi
layer 5	f <sub>pu</sub> =	277 ksi
layer 6	f <sub>pu</sub> =	277 ksi
layer 7	f <sub>pu</sub> =	277 ksi
layer 8	f <sub>pu</sub> =	277 ksi
layer 9	f <sub>pu</sub> =	277 ksi
layer 10	f <sub>pu</sub> =	277 ksi
layer 11	f <sub>pu</sub> =	277 ksi
layer 12	f <sub>pu</sub> =	277 ksi
layer 13	f <sub>pu</sub> =	277 ksi
layer 14	f <sub>pu</sub> =	277 ksi

Yield Strength

initial = 250 ksi

layer 1 (bottom)	f <sub>py</sub> =	250 ksi
layer 2	f <sub>py</sub> =	250 ksi
layer 3	f <sub>py</sub> =	250 ksi
layer 4	f <sub>py</sub> =	250 ksi
layer 5	f <sub>py</sub> =	250 ksi
layer 6	f <sub>py</sub> =	250 ksi
layer 7	f <sub>py</sub> =	250 ksi
layer 8	f <sub>py</sub> =	250 ksi
layer 9	f <sub>py</sub> =	250 ksi
layer 10	f <sub>py</sub> =	250 ksi
layer 11	f <sub>py</sub> =	250 ksi
layer 12	f <sub>py</sub> =	250 ksi
layer 13	f <sub>py</sub> =	250 ksi
layer 14	f <sub>py</sub> =	250 ksi

**Stress Limits:**

before transfer ≤ 0.75f<sub>pu</sub> (initial = 202.5)

layer 1 (bottom)	f <sub>pl</sub> =	207.6 ksi
layer 2	f <sub>pl</sub> =	207.6 ksi
layer 3	f <sub>pl</sub> =	207.6 ksi
layer 4	f <sub>pl</sub> =	207.6 ksi
layer 5	f <sub>pl</sub> =	207.6 ksi
layer 6	f <sub>pl</sub> =	207.6 ksi
layer 7	f <sub>pl</sub> =	207.6 ksi
layer 8	f <sub>pl</sub> =	207.6 ksi
layer 9	f <sub>pl</sub> =	207.6 ksi
layer 10	f <sub>pl</sub> =	207.6 ksi
layer 11	f <sub>pl</sub> =	207.6 ksi
layer 12	f <sub>pl</sub> =	207.6 ksi
layer 13	f <sub>pl</sub> =	207.6 ksi
layer 14	f <sub>pl</sub> =	207.6 ksi

at service limit state (after all losses)  $\leq 0.80f_{py}$  (initial = 194.4)

layer 1 (bottom)	$f_{pe} =$	199.7 ksi
layer 2	$f_{pe} =$	199.7 ksi
layer 3	$f_{pe} =$	199.7 ksi
layer 4	$f_{pe} =$	199.7 ksi
layer 5	$f_{pe} =$	199.7 ksi
layer 6	$f_{pe} =$	199.7 ksi
layer 7	$f_{pe} =$	199.7 ksi
layer 8	$f_{pe} =$	199.7 ksi
layer 9	$f_{pe} =$	199.7 ksi
layer 10	$f_{pe} =$	199.7 ksi
layer 11	$f_{pe} =$	199.7 ksi
layer 12	$f_{pe} =$	199.7 ksi
layer 13	$f_{pe} =$	199.7 ksi
layer 14	$f_{pe} =$	199.7 ksi

Modulus of Elasticity

initial = 25982 ksi

layer 1 (bottom)	E =	25982.0 ksi
layer 2	E =	25982.0 ksi
layer 3	E =	25982.0 ksi
layer 4	E =	25982.0 ksi
layer 5	E =	25982.0 ksi
layer 6	E =	25982.0 ksi
layer 7	E =	25982.0 ksi
layer 8	E =	25982.0 ksi
layer 9	E =	25982.0 ksi
layer 10	E =	25982.0 ksi
layer 11	E =	25982.0 ksi
layer 12	E =	25982.0 ksi
layer 13	E =	25982.0 ksi
layer 14	E =	25982.0 ksi

#### REINFORCING BARS

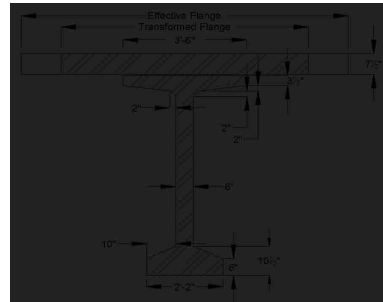
Yield Strength	$f_y =$	57.6 ksi
Modulus of Elasticity	E =	29000.0 ksi

Area of steel at endspan (effective flange)	$A_{se} =$	15.4 in <sup>2</sup>
Area of steel at midspan (effective flange)	$A_{sm} =$	0.0 in <sup>2</sup>
Area of temperature and shrinkage steel (12" width)	$A_s =$	0.0 in <sup>2</sup>

#### Cross-sectional Properties

##### NON-COMPOSITE BEAM

Area of cross-section of beam	A =	767.0 in <sup>2</sup>
Overall depth of beam	H =	72.0 in
Moment of Inertia	I =	539,947 in <sup>4</sup>
Distance from centroid to extreme <b>bottom</b> fiber	$y_b =$	36.6 in
Distance from centroid to extreme <b>top</b> fiber	$y_t =$	35.4 in
Section modulus for the extreme <b>bottom</b> fiber	$S_b =$	14915.0 in <sup>3</sup>
Section modulus for the extreme <b>top</b> fiber	$S_t =$	15421.0 in <sup>3</sup>
Weight	$W_f =$	799.0 plf
Modulus of Elasticity = $33000 \cdot (W_c \cdot 1.5) \cdot (\sqrt{f_c})$		
cast-in-place concrete deck	$E_{cs} =$	3834 ksi
precast beam at release	$E_{ci} =$	4496 ksi
precast beam at service loads	$E_c =$	5072 ksi



**COMPOSITE BEAM AT MIDSPAN**

Effective Flange Width	$b_f =$	111.0 in	*min of three criteria
Modular Ratio = $E_{cs}/E_c$	$n =$	0.7559	
Transformed flange width	$=$	83.9 in	
Transformed flange area	$=$	629.3 in <sup>2</sup>	
Transformed haunch width	$=$	31.7 in	
Transformed haunch area	$=$	15.9 in <sup>2</sup>	

	Transformed Area	$y_b$	$Ay_b$	$A(y_{bc}-y_b)^2$	I	$I + A(y_{bc}-y_b)^2$
Beam	767.0 in <sup>2</sup>	36.60 in	28,072.2 in <sup>3</sup>	250,443 in <sup>4</sup>	539,947 in <sup>4</sup>	790,390 in <sup>4</sup>
Haunch	15.9 in <sup>2</sup>	72.25 in	1,146.9 in <sup>3</sup>	4,906 in <sup>4</sup>	0.33 in <sup>4</sup>	4,906 in <sup>4</sup>
Deck	629.3 in <sup>2</sup>	76.25 in	47,985.0 in <sup>3</sup>	293,069 in <sup>4</sup>	2,950 in <sup>4</sup>	296,019 in <sup>4</sup>
Total	1412.2 in <sup>2</sup>		77,204.1 in <sup>3</sup>			1,091,315 in <sup>4</sup>

Total area of Composite Section	$A_c =$	1412 in <sup>2</sup>
Overall Depth of the Composite Section	$h_c =$	80 in
Moment of Inertia	$I_c =$	1,091,315 in <sup>4</sup>
Distance from centroid to extreme <b>bottom</b> fiber of beam	$y_{bc} =$	54.67 in
Distance from centroid to extreme <b>top</b> fiber of beam	$y_{tg} =$	17.33 in
Distance from centroid to extreme <b>top</b> fiber of slab	$y_{tc} =$	25.33 in
Section modulus for the extreme <b>bottom</b> fiber of beam	$S_{bc} =$	19,961.9 in <sup>3</sup>
Section modulus for the extreme <b>top</b> fiber of beam	$S_{tg} =$	62,972.4 in <sup>3</sup>
Section modulus for the extreme <b>top</b> fiber slab	$S_{tc} =$	56,994.5 in <sup>3</sup>

**Shear Forces and Bending Moments**

**DEAD LOADS**

Beam self-weight	$W_{beam} =$	0.799 k/f
8 in. deck weight	$W_{deck} =$	1.200 k/f
1/2 in. haunch weight	$W_{haunch} =$	0.022 k/f

LRFD Specifications: Art. 4.6.2.2.1

Width of Deck Constant		OK
Number of beams is not less than four $N_b =$	4	OK
Roadway part of the overhang, $d_o \leq 3.0$ ft, $d_o =$	1.5	OK
Curvature in plans is less than $4^\circ =$	0	OK
Cross-section of the bridge is consistent with one of the cross sections given by LRFD specs		OK

Barrier and wearing surface loads are equally distributed among the 4 beams

Barrier Wt	$W_t =$	0.150 k/f
Dead load of future wearing surface	$DW =$	0.263 k/f

**LIVE LOADS**

Fire truck live load front load (Point A)	$P_{live} =$	48.0 kips
Fire truck live load back load (Point B)	$P_{live} =$	22.0 kips
distance between two loads		19.2 ft
distance from nearest edge to point A	$x_a =$	59.0 ft
distance from nearest edge to point B	$x_b =$	39.8 ft

LRFD Specifications: Art. 4.6.2.2.1

Width of Deck Constant		OK
Number of beams is not less than four $N_b =$	4	OK
Beams are parallel and approximately of the same stiffness		OK
Roadway part of the overhang, $d_o \leq 3.0$ ft, $d_o =$	1.5	OK
Curvature in plans is less than $4^\circ =$	0	OK

Barrier and wearing surface loads are equally distributed among the 4 beams

Bridge Type-- "k" (LRFD Table 4.6.2.2.1-1)		
Number of design lanes = $w/12$	$=$	3 lanes

**Distribution Factor for Bending Moment:**

Beams spacing	S =	12.0 ft
Depth of concrete slab	t <sub>s</sub> =	7.5 in
Beam Span	L =	120.0 ft
Number of Beams	N <sub>b</sub> =	4
Modular ratio between beam & deck materials	n =	1.3229
Longitudinal stiffness parameter	K <sub>g</sub> =	2,309,429.79 in <sup>4</sup>

at center span:

$$DFM = 0.75 \left[ \left( \frac{S}{9.5} \right)^{1.6} * \left( \frac{S}{L} \right)^{0.1} * \left( \frac{K_g}{12 * L * t_s^3} \right)^{0.1} \right]$$

DFM =	0.905 lanes/beam
-------	------------------

one design lane loaded:

$$DFM = 0.75 + \left( \frac{S}{14} \right)^{1.4} + \left( \frac{S}{L} \right)^{0.5} + \left( \frac{K_g}{12 * L * t_s^3} \right)^{0.1}$$

DFM =	0.614 lanes/beam
-------	------------------

0.905 Controls

**Distribution Factor for Shear Force**

both end spans and center span:

$$DFV = 0.2 + \left( \frac{S}{12} \right) - \left( \frac{S}{35} \right)^2$$

DFV =	1.082 lanes/beam
-------	------------------

one design lane loaded:

$$DFV = 0.36 + \left( \frac{S}{25} \right)$$

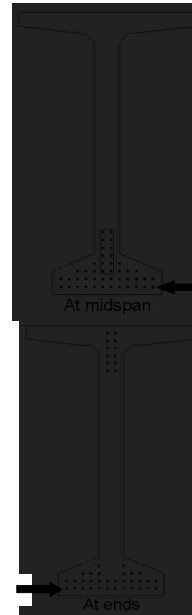
DFV =	0.840 lanes/beam
-------	------------------

1.082 Controls

from bottom	At Midspan		At Ends	
	No. of	Distance from Bottom	No. of	Distance from Bottom
layer 1	12	2	12	2
layer 2	12	4	12	4
layer 3	8	6	6	6
layer 4	4	8	2	8
layer 5	2	10	-	-
layer 6	2	12	-	-
layer 7	2	14	-	-
layer 8	2	16	-	-
layer 9	-	-	2	60
layer 10	-	-	2	62
layer 11	-	-	2	64
layer 12	-	-	2	66
layer 13	-	-	2	68
layer 14	-	-	2	70
<b>Harped Strand Group (included in above totals)</b>				
layer 3	2	6		
layer 4	2	8		
layer 5	2	10		
layer 6	2	12		
layer 7	2	14		
layer 8	2	16		

distance from the center of gravity of strands to the bottom fiber of the beam = 7% of the beam depth  
strand eccentricity at midspan = (y<sub>c</sub> - y<sub>bs</sub>)

y <sub>bs</sub> =	5.82 in
e <sub>c</sub> =	30.78 in



layer 1

## Prestress Losses

### ELASTIC SHORTENING

assumed loss	=	9.00%
Force per strand at transfer		
layer 1	=	28.9 kips
layer 2	=	28.9 kips
layer 3	=	28.9 kips
layer 4	=	28.9 kips
layer 5	=	28.9 kips
layer 6	=	28.9 kips
layer 7	=	28.9 kips
layer 8	=	28.9 kips
layer 9	=	28.9 kips
layer 10	=	28.9 kips
layer 11	=	28.9 kips
layer 12	=	28.9 kips
layer 13	=	28.9 kips
layer 14	=	28.9 kips

		at midspan	at endspan
Total prestressing force at release	$P_1 =$	1271.6 kips	1271.6 kips
Sum of concrete stresses at the center of gravity of prestressing tendons due to prestressing force at transfer and the self-weight of the member at sections of maximum moment	$f_{cgp} =$	2.938 ksi	2.938 ksi
Loss due to shortening		at midspan	at endspan
layer 1	$\Delta f_{pES} =$	17.0 ksi	17.0 ksi
layer 2	$\Delta f_{pES} =$	17.0 ksi	17.0 ksi
layer 3	$\Delta f_{pES} =$	17.0 ksi	17.0 ksi
layer 4	$\Delta f_{pES} =$	17.0 ksi	17.0 ksi
layer 5	$\Delta f_{pES} =$	17.0 ksi	
layer 6	$\Delta f_{pES} =$	17.0 ksi	
layer 7	$\Delta f_{pES} =$	17.0 ksi	
layer 8	$\Delta f_{pES} =$	17.0 ksi	
layer 9	$\Delta f_{pES} =$		17.0 ksi
layer 10	$\Delta f_{pES} =$		17.0 ksi
layer 11	$\Delta f_{pES} =$		17.0 ksi
layer 12	$\Delta f_{pES} =$		17.0 ksi
layer 13	$\Delta f_{pES} =$		17.0 ksi
layer 14	$\Delta f_{pES} =$		17.0 ksi

### SHRINKAGE

Shrinkage = $(17 - 0.15 \cdot \text{Relative Humidity})$	$\Delta f_{pSR} =$	6.5 ksi	← assume relative humidity = 70%
--	--------------------	---------	----------------------------------

### CREEP OF CONCRETE

Change of stresses at center of gravity of prestressing due to permanent loads except the loads acting at time of applying prestressing force, calculated at the same section as $f_{cgp}$	$\Delta f_{cgp} =$	1.563 ksi	
loss due to creep	$\Delta f_{pCR} =$	at midspan 24.3 ksi	at endspan 24.3 ksi

**RELAXATION OF PRESTRESSING STRANDS**

loss due to relaxation after transfer		at midspan	at endspan
layer 1	$\Delta f_{PR2} =$	2.1 ksi	2.1 ksi
layer 2	$\Delta f_{PR2} =$	2.1 ksi	2.1 ksi
layer 3	$\Delta f_{PR2} =$	2.1 ksi	2.1 ksi
layer 4	$\Delta f_{PR2} =$	2.1 ksi	2.1 ksi
layer 5	$\Delta f_{PR2} =$	2.1 ksi	
layer 6	$\Delta f_{PR2} =$	2.1 ksi	
layer 7	$\Delta f_{PR2} =$	2.1 ksi	
layer 8	$\Delta f_{PR2} =$	2.1 ksi	
layer 9	$\Delta f_{PR2} =$		2.1 ksi
layer 10	$\Delta f_{PR2} =$		2.1 ksi
layer 11	$\Delta f_{PR2} =$		2.1 ksi
layer 12	$\Delta f_{PR2} =$		2.1 ksi
layer 13	$\Delta f_{PR2} =$		2.1 ksi
layer 14	$\Delta f_{PR2} =$		2.1 ksi

**TOTAL LOSSES AT TRANSFER**

total loss  $\Delta f_{pES} = \Delta f_{pt}$

stress in tendons after transfer  $f_{pt} = f_{pr} - \Delta f_{pt}$

		at midspan	at endspan
layer 1	$f_{pt} =$	190.6 ksi	190.6 ksi
layer 2	$f_{pt} =$	190.6 ksi	190.6 ksi
layer 3	$f_{pt} =$	190.6 ksi	190.6 ksi
layer 4	$f_{pt} =$	190.6 ksi	190.6 ksi
layer 5	$f_{pt} =$	190.6 ksi	
layer 6	$f_{pt} =$	190.6 ksi	
layer 7	$f_{pt} =$	190.6 ksi	
layer 8	$f_{pt} =$	190.6 ksi	
layer 9	$f_{pt} =$		190.6 ksi
layer 10	$f_{pt} =$		190.6 ksi
layer 11	$f_{pt} =$		190.6 ksi
layer 12	$f_{pt} =$		190.6 ksi
layer 13	$f_{pt} =$		190.6 ksi
layer 14	$f_{pt} =$		190.6 ksi

force per strand =  $f_{pt} \cdot \text{strand area}$

		at midspan	at endspan
layer 1	=	29.2 kips	29.2 kips
layer 2	=	29.2 kips	29.2 kips
layer 3	=	29.2 kips	29.2 kips
layer 4	=	29.2 kips	29.2 kips
layer 5	=	29.2 kips	
layer 6	=	29.2 kips	
layer 7	=	29.2 kips	
layer 8	=	29.2 kips	
layer 9	=		29.2 kips
layer 10	=		29.2 kips
layer 11	=		29.2 kips
layer 12	=		29.2 kips
layer 13	=		29.2 kips
layer 14	=		29.2 kips

Total prestressing force after transfer  $P_i =$  1284.8 kips 1284.8 kips

Initial loss =  $(\Delta f_p)/(f_{pi})$

		at midspan	at endspan
layer 1	% =	8.2%	8.2%
layer 2	% =	8.2%	8.2%
layer 3	% =	8.2%	8.2%
layer 4	% =	8.2%	8.2%
layer 5	% =	8.2%	
layer 6	% =	8.2%	
layer 7	% =	8.2%	
layer 8	% =	8.2%	
layer 9	% =		8.2%
layer 10	% =		8.2%
layer 11	% =		8.2%
layer 12	% =		8.2%
layer 13	% =		8.2%
layer 14	% =		8.2%

OK  
OK  
OK  
OK  
OK  
OK  
OK  
OK  
OK  
OK  
OK  
OK  
OK  
OK

**TOTAL LOSSES AT SERVICE LOADS**

Total Losses		at midspan	at endspan
layer 1	$\Delta f_{pT} =$	49.9 ksi	49.9 ksi
layer 2	$\Delta f_{pT} =$	49.9 ksi	49.9 ksi
layer 3	$\Delta f_{pT} =$	49.9 ksi	49.9 ksi
layer 4	$\Delta f_{pT} =$	49.9 ksi	49.9 ksi
layer 5	$\Delta f_{pT} =$	49.9 ksi	
layer 6	$\Delta f_{pT} =$	49.9 ksi	
layer 7	$\Delta f_{pT} =$	49.9 ksi	
layer 8	$\Delta f_{pT} =$	49.9 ksi	
layer 9	$\Delta f_{pT} =$		49.9 ksi
layer 10	$\Delta f_{pT} =$		49.9 ksi
layer 11	$\Delta f_{pT} =$		49.9 ksi
layer 12	$\Delta f_{pT} =$		49.9 ksi
layer 13	$\Delta f_{pT} =$		49.9 ksi
layer 14	$\Delta f_{pT} =$		49.9 ksi

Stress in tendon after all losses =  $f_{pi} - \Delta f_{pT}$

		at midspan	at endspan
layer 1	$f_{pe} =$	157.7 ksi	157.7 ksi
layer 2	$f_{pe} =$	157.7 ksi	157.7 ksi
layer 3	$f_{pe} =$	157.7 ksi	157.7 ksi
layer 4	$f_{pe} =$	157.7 ksi	157.7 ksi
layer 5	$f_{pe} =$	157.7 ksi	
layer 6	$f_{pe} =$	157.7 ksi	
layer 7	$f_{pe} =$	157.7 ksi	
layer 8	$f_{pe} =$	157.7 ksi	
layer 9	$f_{pe} =$		157.7 ksi
layer 10	$f_{pe} =$		157.7 ksi
layer 11	$f_{pe} =$		157.7 ksi
layer 12	$f_{pe} =$		157.7 ksi
layer 13	$f_{pe} =$		157.7 ksi
layer 14	$f_{pe} =$		157.7 ksi

check prestressing stress limit at service limit state:  $f_{pe} \leq 0.8 \cdot f_{py}$

layer 1	=	199.7 ksi
layer 2	=	199.7 ksi
layer 3	=	199.7 ksi
layer 4	=	199.7 ksi
layer 5	=	199.7 ksi
layer 6	=	199.7 ksi
layer 7	=	199.7 ksi
layer 8	=	199.7 ksi
layer 9	=	199.7 ksi
layer 10	=	199.7 ksi
layer 11	=	199.7 ksi
layer 12	=	199.7 ksi
layer 13	=	199.7 ksi
layer 14	=	199.7 ksi

OK  
OK  
OK  
OK  
OK  
OK  
OK  
OK  
OK  
OK  
OK  
OK  
OK  
OK

force per strand =  $f_{pe}$  \* strand area

		at midspan	at endspan
layer 1	=	24.1 kips	24.1 kips
layer 2	=	24.1 kips	24.1 kips
layer 3	=	24.1 kips	24.1 kips
layer 4	=	24.1 kips	24.1 kips
layer 5	=	24.1 kips	
layer 6	=	24.1 kips	
layer 7	=	24.1 kips	
layer 8	=	24.1 kips	
layer 9	=		24.1 kips
layer 10	=		24.1 kips
layer 11	=		24.1 kips
layer 12	=		24.1 kips
layer 13	=		24.1 kips
layer 14	=		24.1 kips

Total prestressing force after all losses  $P_{pe}$  = 1061.6 kips      1061.6 kips

Final losses, % =  $(\Delta f_{pt}) / (f_{pi})$

		at midspan	at endspan
layer 1	% =	24.0%	24.0%
layer 2	% =	24.0%	24.0%
layer 3	% =	24.0%	24.0%
layer 4	% =	24.0%	24.0%
layer 5	% =	24.0%	
layer 6	% =	24.0%	
layer 7	% =	24.0%	
layer 8	% =	24.0%	
layer 9	% =		24.0%
layer 10	% =		24.0%
layer 11	% =		24.0%
layer 12	% =		24.0%
layer 13	% =		24.0%
layer 14	% =		24.0%
Average final losses, %	% =	24.0%	24.0%

### Stresses at Transfer

#### STRESS LIMITS FOR CONCRETE

Compression = $0.6f_{ci}$	$f_{ci}$ =	3.300 ksi
Tension		
without bonded reinforcement = $-0.0948\sqrt{f_{ci}} \leq -0.2$	=	-0.200 ksi
with bonded auxiliary reinforcement = $-0.22\sqrt{f_{ci}}$	=	-0.016 ksi

#### STRESSES AT TRANSFER LENGTH SECTION

Transfer Length = $60 \times$ (strand diameter)	=	2.5 ft	} Calcs for eccentricity (see 9.6.7.2)
Bending moment at transfer length	$M_g$ =	116.4 ft-kips	
center of 12 strands to top fiber of beam at the end	=	7.00 in	
center of 12 strands to bottom fiber of beam at the harp point	=	11.00 in	
center of 12 strands and top fiber of beam at transfer length	=	10.78 in	
center of gravity of 32 strands and bottom fiber of beam	=	3.88 in	
center of gravity of all strands and the bottom fiber of beam at transfer length	=	19.51 in	
center of gravity of all strands and the bottom fiber of beam at the end	=	20.55 in	
Eccentricity of the strand group at transfer length:	$e_h$ =	17.09 in	
Eccentricity at end of beam:	$e$ =	16.05 in	

$$f_t = \frac{P_i}{A} - \frac{P_i e}{S_t} + \frac{M_g}{S_t}$$

$$f_b = \frac{P_i}{A} + \frac{P_i e}{S_b} - \frac{M_g}{S_b}$$

		at midspan	at endspan
Top stress at top fiber of beam	$f_t$ =	0.342 ksi	0.342 ksi
Bottom stress at bottom fiber of the beam	$f_b$ =	3.021 ksi	3.021 ksi

OK  
OK



STRESSES AT HARP POINT			
Bending moment due to beam weight at 0.3L	$M_g =$	1188.0 ft-kips	
Top stress at top fiber of beam	$f_t =$	0.035 ksi	0.035 ksi
Bottom stress at bottom fiber of the beam	$f_b =$	3.300 ksi	3.300 ksi

OK  
OK

STRESSES AT MIDSPAN			
Bending moment due to beam weight at 0.5L	$M_g =$	1414.3 ft-kips	
Top stress at top fiber of beam	$f_t =$	0.220 ksi	0.211 ksi
Bottom stress at bottom fiber of the beam	$f_b =$	3.144 ksi	3.189 ksi

OK  
OK

#### HOLD-DOWN FORCES

assume stress in strand before losses =  $0.8f_u$

layer 1	=	221.4 ksi
layer 2	=	221.4 ksi
layer 3	=	221.4 ksi
layer 4	=	221.4 ksi
layer 5	=	221.4 ksi
layer 6	=	221.4 ksi
layer 7	=	221.4 ksi
layer 8	=	221.4 ksi
layer 9	=	221.4 ksi
layer 10	=	221.4 ksi
layer 11	=	221.4 ksi
layer 12	=	221.4 ksi
layer 13	=	221.4 ksi
layer 14	=	221.4 ksi

prestress force per strand before any losses:

layer 1	=	33.9 kips
layer 2	=	33.9 kips
layer 3	=	33.9 kips
layer 4	=	33.9 kips
layer 5	=	33.9 kips
layer 6	=	33.9 kips
layer 7	=	33.9 kips
layer 8	=	33.9 kips
layer 9	=	33.9 kips
layer 10	=	33.9 kips
layer 11	=	33.9 kips
layer 12	=	33.9 kips
layer 13	=	33.9 kips
layer 14	=	33.9 kips
Harp Angle	$\psi =$	7.2 °

Hold-down force/strand

layer 1	=	4.4 kips/strand
layer 2	=	4.4 kips/strand
layer 3	=	4.4 kips/strand
layer 4	=	4.4 kips/strand
layer 5	=	4.4 kips/strand
layer 6	=	4.4 kips/strand
layer 7	=	4.4 kips/strand
layer 8	=	4.4 kips/strand
layer 9	=	4.4 kips/strand
layer 10	=	4.4 kips/strand
layer 11	=	4.4 kips/strand
layer 12	=	4.4 kips/strand
layer 13	=	4.4 kips/strand
layer 14	=	4.4 kips/strand
Total hold-down force	=	53.39 kips

### Stresses at Service Loads

#### STRESS LIMITS FOR CONCRETE

##### Compression:

Due to permanent loads for load combination Service I

for the precast beam	=	3.150 ksi
for deck	=	1.800 ksi

Due to permanent and transient loads for load combination Service I

for the precast beam	=	4.200 ksi
for deck	=	2.400 ksi

##### Tension:

Load Combination Service III

for the precast beam	=	-0.016 ksi
----------------------	---	------------

#### STRESSES AT MIDSPAN

Compression stresses at top fiber of beam	at midspan	at endspan		
$f_t = \frac{P_{ps}}{A} - \frac{P_{ps}e}{S_t} + \frac{(M_u + M_{d1})}{S_t} + \frac{(M_w + M_b)}{S_{tr}}$				
Due to permanent loads	$f_{t0} =$	2.041 ksi	2.041 ksi	OK
$f_{tr} = \frac{P_{ps}}{A} - \frac{P_{ps}e}{S_t} + \frac{(M_u + M_{d1})}{S_t} + \frac{(M_w - M_b)}{S_{tr}} + \frac{(M_{LL1})}{S_{tr}}$				
Due to permanent loads and transient loads	$f_{t0} =$	2.444 ksi	2.444 ksi	OK
Compression stresses at top fiber of deck	at midspan	at endspan		
$f_{tc} = \frac{(M_w + M_b)}{S_{tr}}$				
Due to permanent loads	$f_{tc} =$	0.042 ksi	0.042 ksi	OK
$f_{tr} = \frac{(M_w + M_b + M_{LL1})}{S_{tr}}$				
Due to permanent loads and transient loads	$f_{tc} =$	0.488 ksi	0.488 ksi	OK
Tension stresses at top fiber of deck	at midspan	at endspan		
$f_{tr} = \frac{P_{ps}}{A} + \frac{P_{ps}e}{S_b} - \frac{(M_u + M_{d1})}{S_b} - \frac{(M_w + M_b + 0.8M_{LL1})}{S_{tr}}$				
Load Combination Service III	$f_b =$	-0.393 ksi	-0.393 ksi	OK

### Strength Limit State

#### POSITIVE MOMENT SECTION

$M_u = 1.25DC + 1.5DW + 1.75(LL+IM)$	$M_u =$	8381.5 ft-kips
--------------------------------------	---------	----------------

effective length factor for compression members

layer 1	k =	0.28
layer 2	k =	0.28
layer 3	k =	0.28
layer 4	k =	0.28
layer 5	k =	0.28
layer 6	k =	0.28
layer 7	k =	0.28
layer 8	k =	0.28
layer 9	k =	0.28
layer 10	k =	0.28
layer 11	k =	0.28
layer 12	k =	0.28
layer 13	k =	0.28
layer 14	k =	0.28
c =		5.7 ft-kips

average stress in prestressing steel

layer 1	$f_{ps} =$	270.9 ksi
layer 2	$f_{ps} =$	270.9 ksi
layer 3	$f_{ps} =$	270.9 ksi
layer 4	$f_{ps} =$	270.9 ksi
layer 5	$f_{ps} =$	270.9 ksi
layer 6	$f_{ps} =$	270.9 ksi
layer 7	$f_{ps} =$	270.9 ksi
layer 8	$f_{ps} =$	270.9 ksi
layer 9	$f_{ps} =$	270.9 ksi
layer 10	$f_{ps} =$	270.9 ksi
layer 11	$f_{ps} =$	270.9 ksi
layer 12	$f_{ps} =$	270.9 ksi
layer 13	$f_{ps} =$	270.9 ksi
layer 14	$f_{ps} =$	270.9 ksi

nominal flexure resistance

	$a =$	4.87 in	
$M_r = \Phi M_n, \Phi = 1.00$	$\Phi M_n =$	10902.9 ft-kips	OK
$M = DC+W+LL+IM$	$M =$	5833.6 ft-kips	OK
<b>NEGATIVE MOMENT SECTION</b>			
$M_u = 1.25DC+1.5DW+1.75(LL+IM)$	$M_u =$	4837.2 ft-kips	
	$a =$	5.73 in	
	$\Phi M_n =$	4879.0 ft-kips	OK
$M = DC+W+LL+IM$	$M =$	2869.7 ft-kips	OK

### Shear Design

<b>CRITICAL SECTION AT 0.59</b>			
$V_u = 1.25DC+1.5DW+1.75(LL+IM)$	$V_u =$	405.0 kips	
$M_u = 1.25DC+1.5DW+1.75(LL+IM)$	$M_u =$	-2684.4 ft-kips	
or			
$V_u = 1.25DC+1.5DW+1.75(LL+IM)$	$V_u =$	364.8 kips	
$M_u = 1.25DC+1.5DW+1.75(LL+IM)$	$M_u =$	-2877.0 ft-kips	
max shear	$V_u =$	405.0 kips	
max moment	$M_u =$	2877.0 ft-kips	
Shear depth	$d_v =$	73.19 in	
Applied factored normal force at the section	$N_u =$	0	
Angle of diagonal compressive stresses	$\theta =$	36.00 °	

### STRAIN IN FLEXURAL TENSION REINFORCEMENT

$$\epsilon_s = \frac{\frac{M_u}{d_v} + 0.5N_u + 0.25V_u \cot \theta + A_{ps} f_{ps}}{E_s A_s + E_p A_{ps}} \leq 0.002$$

		<b>at midspan</b>	<b>at endspan</b>
resultant compressive stress at centroid	$f_{pc} =$	0.994 ksi	0.994 ksi

effective stress in prestressing strand after all losses

layer 1	$f_{po} =$	162.8 ksi	162.8 ksi
layer 2	$f_{po} =$	162.8 ksi	162.8 ksi
layer 3	$f_{po} =$	162.8 ksi	162.8 ksi
layer 4	$f_{po} =$	162.8 ksi	162.8 ksi
layer 5	$f_{po} =$	162.8 ksi	
layer 6	$f_{po} =$	162.8 ksi	
layer 7	$f_{po} =$	162.8 ksi	
layer 8	$f_{po} =$	162.8 ksi	
layer 9	$f_{po} =$		162.8 ksi
layer 10	$f_{po} =$		162.8 ksi
layer 11	$f_{po} =$		162.8 ksi
layer 12	$f_{po} =$		162.8 ksi
layer 13	$f_{po} =$		162.8 ksi
layer 14	$f_{po} =$		162.8 ksi

strain in flexural tension

		at midspan	at endspan
layer 1	$\epsilon_x =$	0.002000	0.002000
layer 2	$\epsilon_x =$	0.002000	0.002000
layer 3	$\epsilon_x =$	0.002000	0.002000
layer 4	$\epsilon_x =$	0.002000	0.002000
layer 5	$\epsilon_x =$	0.002000	
layer 6	$\epsilon_x =$	0.002000	
layer 7	$\epsilon_x =$	0.002000	
layer 8	$\epsilon_x =$	0.002000	
layer 9	$\epsilon_x =$		0.002000
layer 10	$\epsilon_x =$		0.002000
layer 11	$\epsilon_x =$		0.002000
layer 12	$\epsilon_x =$		0.002000
layer 13	$\epsilon_x =$		0.002000
layer 14	$\epsilon_x =$		0.002000

### Deflection and Camber

		at midspan	at endspan
Deflection due to Prestressing Force at Transfer	$\Delta_p =$	3.97 in	3.97 in
Deflection due to Beam Self-Weight at Transfer	$\Delta_g =$	-1.49 in	
Deflection due to Beam Self-Weight at Erection	$\Delta_g =$	-1.27 in	
Deflection due to Haunch and Deck	$\Delta_s =$	-1.95 in	
Deflection due to total self weight	$\Delta_{sw} =$	0.75 in	
Total Deflection at transfer	$\Delta =$	2.48 in	2.48 in
Total Deflection at erection	$\Delta =$	4.79 in	4.79 in
Live load deflection limit = span/800	$=$	-1.80 in	
Deflection due to live load and impact	$\Delta_L =$	-0.79 in	
Deflection due to fire truck	$\Delta_L =$	-1.4447 in	
Total Deflection after fire with fire truck	$\Delta =$	3.2736 in	

OK

OK

**Location: Fire at Critical Positive Moment Sections**  
**Beam Design: 1/2" Strand**  
**Fire Exposure Status: 1/2 Hour**

(PCI Bridge Design Manual Section 9.6)

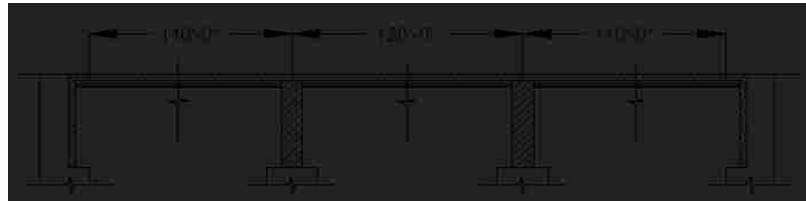


**Material Properties**

CAST-IN-PLACE SLAB			
Actual Thickness	$t_{as} =$		8.0 in
Wearing Surface	$=$		0.5 in
Structural thickness = Actual - Wearing Surface	$t_s =$		7.5 in
Compressive Strength	$f'_c =$		4 ksi
Unit Weight	$w_c =$		150.0 pcf
Stress factor of compression block	$\beta_1 =$		0.85

BEAMS: AASHTO-PCI, BT-72 BULB-TEE			
Strength at release	$f_{ci} =$		5.5 ksi
Strength at 28 days	$f'_c =$		6.79 ksi
Unit Weight	$w_c =$		150.0 pcf
Overall Beam Length:			
@ end spans	$L =$		110 ft
@ center span	$L =$		119 ft
Design Spans:			
Non-composite beam @ end spans	$L =$		109 ft
Non-composite beam @ center span	$L =$		118 ft
Composite beam @ end spans	$L =$		110 ft
Composite beam @ center span	$L =$		120 ft
Beam Spacing	$S =$		12 ft



**PRESTRESSING STRANDS**

Diameter of single strand	d =	0.5 in
Area of single strand	A =	0.153 in <sup>2</sup>

Temperature of Layer

layer 1 (bottom)	T =	260.00 °F
layer 2	T =	180.00 °F
layer 3	T =	160.00 °F
layer 4	T =	130.00 °F
layer 5	T =	115.00 °F
layer 6	T =	68.00 °F
layer 7	T =	68.00 °F
layer 8	T =	68.00 °F
layer 9	T =	68.00 °F
layer 10	T =	68.00 °F
layer 11	T =	68.00 °F
layer 12	T =	68.00 °F
layer 13	T =	68.00 °F
layer 14	T =	68.00 °F

Ultimate Strength

initial = 277 ksi

layer 1 (bottom)	f <sub>pu</sub> =	271 ksi
layer 2	f <sub>pu</sub> =	274 ksi
layer 3	f <sub>pu</sub> =	274 ksi
layer 4	f <sub>pu</sub> =	274 ksi
layer 5	f <sub>pu</sub> =	277 ksi
layer 6	f <sub>pu</sub> =	277 ksi
layer 7	f <sub>pu</sub> =	277 ksi
layer 8	f <sub>pu</sub> =	277 ksi
layer 9	f <sub>pu</sub> =	277 ksi
layer 10	f <sub>pu</sub> =	277 ksi
layer 11	f <sub>pu</sub> =	277 ksi
layer 12	f <sub>pu</sub> =	277 ksi
layer 13	f <sub>pu</sub> =	277 ksi
layer 14	f <sub>pu</sub> =	277 ksi

Yield Strength

initial = 250 ksi

layer 1 (bottom)	f <sub>py</sub> =	247 ksi
layer 2	f <sub>py</sub> =	247 ksi
layer 3	f <sub>py</sub> =	247 ksi
layer 4	f <sub>py</sub> =	250 ksi
layer 5	f <sub>py</sub> =	250 ksi
layer 6	f <sub>py</sub> =	250 ksi
layer 7	f <sub>py</sub> =	250 ksi
layer 8	f <sub>py</sub> =	250 ksi
layer 9	f <sub>py</sub> =	250 ksi
layer 10	f <sub>py</sub> =	250 ksi
layer 11	f <sub>py</sub> =	250 ksi
layer 12	f <sub>py</sub> =	250 ksi
layer 13	f <sub>py</sub> =	250 ksi
layer 14	f <sub>py</sub> =	250 ksi

**Stress Limits:**

before transfer ≤ 0.75f<sub>pu</sub> (initial = 202.5)

layer 1 (bottom)	f <sub>di</sub> =	203.4 ksi
layer 2	f <sub>di</sub> =	205.5 ksi
layer 3	f <sub>di</sub> =	205.5 ksi
layer 4	f <sub>di</sub> =	205.5 ksi
layer 5	f <sub>di</sub> =	207.6 ksi
layer 6	f <sub>di</sub> =	207.6 ksi
layer 7	f <sub>di</sub> =	207.6 ksi
layer 8	f <sub>di</sub> =	207.6 ksi
layer 9	f <sub>di</sub> =	207.6 ksi
layer 10	f <sub>di</sub> =	207.6 ksi
layer 11	f <sub>di</sub> =	207.6 ksi
layer 12	f <sub>di</sub> =	207.6 ksi
layer 13	f <sub>di</sub> =	207.6 ksi
layer 14	f <sub>di</sub> =	207.6 ksi

at service limit state (after all losses)  $\leq 0.80f_{py}$  (initial = 194.4)

layer 1 (bottom)	$f_{pe} =$	197.7 ksi
layer 2	$f_{pe} =$	197.7 ksi
layer 3	$f_{pe} =$	197.7 ksi
layer 4	$f_{pe} =$	199.7 ksi
layer 5	$f_{pe} =$	199.7 ksi
layer 6	$f_{pe} =$	199.7 ksi
layer 7	$f_{pe} =$	199.7 ksi
layer 8	$f_{pe} =$	199.7 ksi
layer 9	$f_{pe} =$	199.7 ksi
layer 10	$f_{pe} =$	199.7 ksi
layer 11	$f_{pe} =$	199.7 ksi
layer 12	$f_{pe} =$	199.7 ksi
layer 13	$f_{pe} =$	199.7 ksi
layer 14	$f_{pe} =$	199.7 ksi

Modulus of Elasticity

initial = 25982 ksi

layer 1 (bottom)	E =	26761.5 ksi
layer 2	E =	26501.6 ksi
layer 3	E =	26501.6 ksi
layer 4	E =	26241.8 ksi
layer 5	E =	26241.8 ksi
layer 6	E =	25982.0 ksi
layer 7	E =	25982.0 ksi
layer 8	E =	25982.0 ksi
layer 9	E =	25982.0 ksi
layer 10	E =	25982.0 ksi
layer 11	E =	25982.0 ksi
layer 12	E =	25982.0 ksi
layer 13	E =	25982.0 ksi
layer 14	E =	25982.0 ksi

#### REINFORCING BARS

Yield Strength	$f_y =$	57.6 ksi
Modulus of Elasticity	E =	29000.0 ksi

Area of steel at endspan (effective flange)  $A_{se} =$  15.4 in<sup>2</sup>

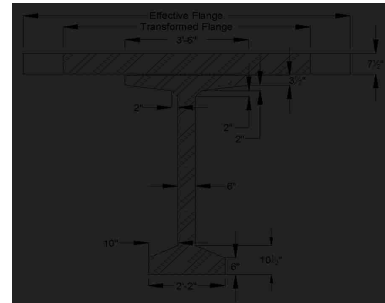
Area of steel at midspan (effective flange)  $A_{sm} =$  0.0 in<sup>2</sup>

Area of temperature and shrinkage steel (12" width)  $A_s =$  0.0 in<sup>2</sup>

#### Cross-sectional Properties

##### NON-COMPOSITE BEAM

Area of cross-section of beam	A =	767.0 in <sup>2</sup>
Overall depth of beam	H =	72.0 in
Moment of Inertia	I =	482,740 in <sup>4</sup>
Distance from centroid to extreme <b>bottom</b> fiber	$y_b =$	38.5 in
Distance from centroid to extreme <b>top</b> fiber	$y_t =$	33.5 in
Section modulus for the extreme <b>bottom</b> fiber	$S_b =$	14915.0 in <sup>3</sup>
Section modulus for the extreme <b>top</b> fiber	$S_t =$	15421.0 in <sup>3</sup>
Weight	$W_f =$	799.0 plf
Modulus of Elasticity = $33000 \cdot (W_c \cdot 1.5) \cdot (\sqrt{f_c})$		
cast-in-place concrete deck	$E_{cs} =$	3834 ksi
precast beam at release	$E_{ci} =$	4496 ksi
precast beam at service loads	$E_c =$	4996 ksi



**COMPOSITE BEAM AT MIDSPAN**

Effective Flange Width	$b_f =$	111.0 in	*min of three criteria
Modular Ratio = $E_{cs}/E_c$	$n =$	0.7675	
Transformed flange width	$=$	85.2 in	
Transformed flange area	$=$	639.0 in <sup>2</sup>	
Transformed haunch width	$=$	32.2 in	
Transformed haunch area	$=$	16.1 in <sup>2</sup>	

	Transformed Area	$y_b$	$Ay_b$	$A(y_{bc}-y_b)^2$	I	$I + A(y_{bc}-y_b)^2$
Beam	767.0 in <sup>2</sup>	38.50 in	29,529.5 in <sup>3</sup>	230,732 in <sup>4</sup>	482,740 in <sup>4</sup>	713,471 in <sup>4</sup>
Haunch	16.1 in <sup>2</sup>	72.25 in	1,164.5 in <sup>3</sup>	4,338 in <sup>4</sup>	0.33 in <sup>4</sup>	4,338 in <sup>4</sup>
Deck	639.0 in <sup>2</sup>	76.25 in	48,721.3 in <sup>3</sup>	266,063 in <sup>4</sup>	2,950 in <sup>4</sup>	269,012 in <sup>4</sup>
Total	1422.1 in <sup>2</sup>		79,415.4 in <sup>3</sup>			986,822 in <sup>4</sup>

Total area of Composite Section	$A_c =$	1422 in <sup>2</sup>
Overall Depth of the Composite Section	$h_c =$	80 in
Moment of Inertia	$I_c =$	986,822 in <sup>4</sup>
Distance from centroid to extreme <u>bottom</u> fiber of beam	$y_{bc} =$	55.84 in
Distance from centroid to extreme <u>top</u> fiber of beam	$y_{tg} =$	16.16 in
Distance from centroid to extreme <u>top</u> fiber of slab	$y_{tc} =$	24.16 in
Section modulus for the extreme <u>bottom</u> fiber of beam	$S_{bc} =$	17,671.0 in <sup>3</sup>
Section modulus for the extreme <u>top</u> fiber of beam	$S_{tg} =$	61,081.8 in <sup>3</sup>
Section modulus for the extreme <u>top</u> fiber slab	$S_{tc} =$	53,226.0 in <sup>3</sup>

**Shear Forces and Bending Moments**

**DEAD LOADS**

Beam self-weight	$w_{beam} =$	0.799 k/f
8 in. deck weight	$w_{deck} =$	1.200 k/f
1/2 in. haunch weight	$w_{haunch} =$	0.022 k/f

LRFD Specifications: Art. 4.6.2.2.1

Width of Deck Constant		OK
Number of beams is not less than four $N_b =$	4	OK
Roadway part of the overhang, $d_o \leq 3.0$ ft, $d_o =$	1.5	OK
Curvature in plans is less than $4^\circ =$	0	OK
Cross-section of the bridge is consistent with one of the cross sections given by LRFD specs		OK

Barrier and wearing surface loads are equally distributed among the 4 beams

Barrier Wt	$Wt =$	0.150 k/f
Dead load of future wearing surface	$DW =$	0.263 k/f

**LIVE LOADS**

Fire truck live load front load (Point A)	$P_{live} =$	48.0 kips
Fire truck live load back load (Point B)	$P_{live} =$	22.0 kips
distance between two loads		19.2 ft
distance from nearest edge to point A	$x_a =$	59.0 ft
distance from nearest edge to point B	$x_b =$	39.8 ft

LRFD Specifications: Art. 4.6.2.2.1

Width of Deck Constant		OK
Number of beams is not less than four $N_b =$	4	OK
Beams are parallel and approximately of the same stiffness		OK
Roadway part of the overhang, $d_o \leq 3.0$ ft, $d_o =$	1.5	OK
Curvature in plans is less than $4^\circ =$	0	OK

Barrier and wearing surface loads are equally distributed among the 4 beams

Bridge Type-- "k" (LRFD Table 4.6.2.2.1-1)

Number of design lanes = $w/12$	$=$	3 lanes
---------------------------------	-----	---------



**Distribution Factor for Bending Moment:**

Beams spacing	S =	12.0 ft
Depth of concrete slab	t <sub>s</sub> =	7.5 in
Beam Span	L =	120.0 ft
Number of Beams	N <sub>b</sub> =	4
Modular ratio between beam & deck materials	n =	1.3029
Longitudinal stiffness parameter	K <sub>g</sub> =	2,199,990.66 in <sup>4</sup>

at center span:

$$DFM = 0.75 + \left(\frac{S}{9.5}\right)^{1.6} * \left(\frac{S}{L}\right)^{0.1} * \left(\frac{K_g}{12 * L * t_s^3}\right)^{0.1}$$

DFM =	0.901 lanes/beam
-------	------------------

one design lane loaded:

$$DFM = 0.75 + \left(\frac{S}{14}\right)^{1.6} * \left(\frac{S}{L}\right)^{0.1} * \left(\frac{K_g}{12 * L * t_s^3}\right)^{0.1}$$

DFM =	0.611 lanes/beam
-------	------------------

0.905 Controls

**Distribution Factor for Shear Force**

both end spans and center span:

$$DFV = 0.2 + \left(\frac{S}{12}\right) - \left(\frac{S}{35}\right)^2$$

DFV =	1.082 lanes/beam
-------	------------------

one design lane loaded:

$$DFV = 0.36 + \left(\frac{S}{25}\right)$$

DFV =	0.840 lanes/beam
-------	------------------

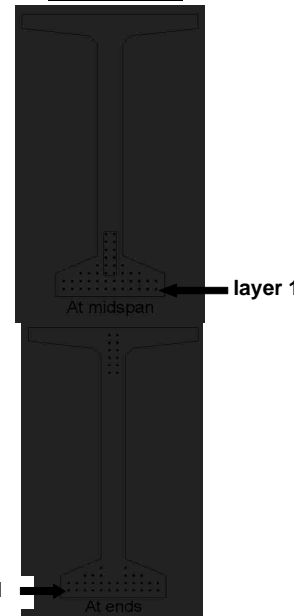
1.082 Controls

from bottom	At Midspan		At Ends	
	No. of	Distance from Bottom	No. of	Distance from Bottom
layer 1	12	2	12	2
layer 2	12	4	12	4
layer 3	8	6	6	6
layer 4	4	8	2	8
layer 5	2	10	-	-
layer 6	2	12	-	-
layer 7	2	14	-	-
layer 8	2	16	-	-
layer 9	-	-	2	60
layer 10	-	-	2	62
layer 11	-	-	2	64
layer 12	-	-	2	66
layer 13	-	-	2	68
layer 14	-	-	2	70
<b>Harped Strand Group (included in above totals)</b>				
layer 3	2	6		
layer 4	2	8		
layer 5	2	10		
layer 6	2	12		
layer 7	2	14		
layer 8	2	16		

distance from the center of gravity of strands to the bottom fiber of the beam = 7% of the beam depth  
strand eccentricity at midspan = (y<sub>c</sub> - y<sub>bs</sub>)

y <sub>bs</sub> =	5.82 in
e <sub>c</sub> =	32.68 in

layer 1



## Prestress Losses

### ELASTIC SHORTENING

assumed loss	=	9.00%
Force per strand at transfer		
layer 1	=	28.3 kips
layer 2	=	28.6 kips
layer 3	=	28.6 kips
layer 4	=	28.6 kips
layer 5	=	28.9 kips
layer 6	=	28.9 kips
layer 7	=	28.9 kips
layer 8	=	28.9 kips
layer 9	=	28.9 kips
layer 10	=	28.9 kips
layer 11	=	28.9 kips
layer 12	=	28.9 kips
layer 13	=	28.9 kips
layer 14	=	28.9 kips

		at midspan	at endspan
Total prestressing force at release	$P_i =$	1257.2 kips	1258.4 kips
Sum of concrete stresses at the center of gravity of prestressing tendons due to prestressing force at transfer and the self-weight of the member at sections of maximum moment	$f_{cgp} =$	3.291 ksi	3.295 ksi
Loss due to shortening		at midspan	at endspan
layer 1	$\Delta f_{pES} =$	19.6 ksi	19.6 ksi
layer 2	$\Delta f_{pES} =$	19.4 ksi	19.4 ksi
layer 3	$\Delta f_{pES} =$	19.4 ksi	19.4 ksi
layer 4	$\Delta f_{pES} =$	19.2 ksi	19.2 ksi
layer 5	$\Delta f_{pES} =$	19.2 ksi	
layer 6	$\Delta f_{pES} =$	19.0 ksi	
layer 7	$\Delta f_{pES} =$	19.0 ksi	
layer 8	$\Delta f_{pES} =$	19.0 ksi	
layer 9	$\Delta f_{pES} =$		19.0 ksi
layer 10	$\Delta f_{pES} =$		19.0 ksi
layer 11	$\Delta f_{pES} =$		19.0 ksi
layer 12	$\Delta f_{pES} =$		19.0 ksi
layer 13	$\Delta f_{pES} =$		19.0 ksi
layer 14	$\Delta f_{pES} =$		19.0 ksi

### SHRINKAGE

Shrinkage = $(17 - 0.15 \cdot \text{Relative Humidity})$	$\Delta f_{BSR} =$	6.5 ksi	← assume relative humidity = 70%
--	--------------------	---------	----------------------------------

### CREEP OF CONCRETE

Change of stresses at center of gravity of prestressing due to permanent loads except the loads acting at time of applying prestressing force, calculated at the same section as $f_{cgp}$	$\Delta f_{csp} =$	1.850 ksi	
loss due to creep	$\Delta f_{PCR} =$	at midspan 26.5 ksi	at endspan 26.6 ksi

**RELAXATION OF PRESTRESSING STRANDS**

loss due to relaxation after transfer		at midspan	at endspan
layer 1	$\Delta f_{PR2} =$	1.7 ksi	1.7 ksi
layer 2	$\Delta f_{PR2} =$	1.7 ksi	1.7 ksi
layer 3	$\Delta f_{PR2} =$	1.7 ksi	1.7 ksi
layer 4	$\Delta f_{PR2} =$	1.7 ksi	1.7 ksi
layer 5	$\Delta f_{PR2} =$	1.7 ksi	
layer 6	$\Delta f_{PR2} =$	1.7 ksi	
layer 7	$\Delta f_{PR2} =$	1.7 ksi	
layer 8	$\Delta f_{PR2} =$	1.7 ksi	
layer 9	$\Delta f_{PR2} =$		1.7 ksi
layer 10	$\Delta f_{PR2} =$		1.7 ksi
layer 11	$\Delta f_{PR2} =$		1.7 ksi
layer 12	$\Delta f_{PR2} =$		1.7 ksi
layer 13	$\Delta f_{PR2} =$		1.7 ksi
layer 14	$\Delta f_{PR2} =$		1.7 ksi

**TOTAL LOSSES AT TRANSFER**

total loss  $\Delta f_{pES} = \Delta f_{pt}$

stress in tendons after transfer  $f_{pt} = f_{pr} - \Delta f_{pt}$

		at midspan	at endspan
layer 1	$f_{pt} =$	183.9 ksi	183.8 ksi
layer 2	$f_{pt} =$	186.1 ksi	186.1 ksi
layer 3	$f_{pt} =$	186.1 ksi	186.1 ksi
layer 4	$f_{pt} =$	186.3 ksi	186.3 ksi
layer 5	$f_{pt} =$	188.4 ksi	
layer 6	$f_{pt} =$	188.6 ksi	
layer 7	$f_{pt} =$	188.6 ksi	
layer 8	$f_{pt} =$	188.6 ksi	
layer 9	$f_{pt} =$		188.6 ksi
layer 10	$f_{pt} =$		188.6 ksi
layer 11	$f_{pt} =$		188.6 ksi
layer 12	$f_{pt} =$		188.6 ksi
layer 13	$f_{pt} =$		188.6 ksi
layer 14	$f_{pt} =$		188.6 ksi

force per strand =  $f_{pt} \cdot \text{strand area}$

		at midspan	at endspan
layer 1	=	28.1 kips	28.1 kips
layer 2	=	28.5 kips	28.5 kips
layer 3	=	28.5 kips	28.5 kips
layer 4	=	28.5 kips	28.5 kips
layer 5	=	28.8 kips	
layer 6	=	28.9 kips	
layer 7	=	28.9 kips	
layer 8	=	28.9 kips	
layer 9	=		28.8 kips
layer 10	=		28.8 kips
layer 11	=		28.8 kips
layer 12	=		28.8 kips
layer 13	=		28.8 kips
layer 14	=		28.8 kips

Total prestressing force after transfer  $P_i =$  1252.2 kips 1252.8 kips

Initial loss =  $(\Delta f_p)/(f_p)$

		at midspan	at endspan
layer 1	% =	9.6%	9.6%
layer 2	% =	9.4%	9.5%
layer 3	% =	9.4%	9.5%
layer 4	% =	9.3%	9.4%
layer 5	% =	9.3%	
layer 6	% =	9.2%	
layer 7	% =	9.2%	
layer 8	% =	9.2%	
layer 9	% =		9.2%
layer 10	% =		9.2%
layer 11	% =		9.2%
layer 12	% =		9.2%
layer 13	% =		9.2%
layer 14	% =		9.2%

OK  
OK  
OK  
OK  
OK  
OK  
OK  
OK  
OK  
OK  
OK  
OK  
OK  
OK

**TOTAL LOSSES AT SERVICE LOADS**

Total Losses		at midspan	at endspan
layer 1	$\Delta f_{pT} =$	54.3 ksi	54.3 ksi
layer 2	$\Delta f_{pT} =$	54.1 ksi	54.1 ksi
layer 3	$\Delta f_{pT} =$	54.1 ksi	54.1 ksi
layer 4	$\Delta f_{pT} =$	53.9 ksi	53.9 ksi
layer 5	$\Delta f_{pT} =$	53.9 ksi	
layer 6	$\Delta f_{pT} =$	53.7 ksi	
layer 7	$\Delta f_{pT} =$	53.7 ksi	
layer 8	$\Delta f_{pT} =$	53.7 ksi	
layer 9	$\Delta f_{pT} =$		53.7 ksi
layer 10	$\Delta f_{pT} =$		53.7 ksi
layer 11	$\Delta f_{pT} =$		53.7 ksi
layer 12	$\Delta f_{pT} =$		53.7 ksi
layer 13	$\Delta f_{pT} =$		53.7 ksi
layer 14	$\Delta f_{pT} =$		53.7 ksi

Stress in tendon after all losses =  $f_{pe} - \Delta f_{pT}$

		at midspan	at endspan
layer 1	$f_{pe} =$	149.2 ksi	149.1 ksi
layer 2	$f_{pe} =$	151.4 ksi	151.4 ksi
layer 3	$f_{pe} =$	151.4 ksi	151.4 ksi
layer 4	$f_{pe} =$	151.6 ksi	151.6 ksi
layer 5	$f_{pe} =$	153.7 ksi	
layer 6	$f_{pe} =$	153.9 ksi	
layer 7	$f_{pe} =$	153.9 ksi	
layer 8	$f_{pe} =$	153.9 ksi	
layer 9	$f_{pe} =$		153.9 ksi
layer 10	$f_{pe} =$		153.9 ksi
layer 11	$f_{pe} =$		153.9 ksi
layer 12	$f_{pe} =$		153.9 ksi
layer 13	$f_{pe} =$		153.9 ksi
layer 14	$f_{pe} =$		153.9 ksi

check prestressing stress limit at service limit state:  $f_{pe} \leq 0.8 f_{py}$

layer 1	=	197.7 ksi
layer 2	=	197.7 ksi
layer 3	=	197.7 ksi
layer 4	=	199.7 ksi
layer 5	=	199.7 ksi
layer 6	=	199.7 ksi
layer 7	=	199.7 ksi
layer 8	=	199.7 ksi
layer 9	=	199.7 ksi
layer 10	=	199.7 ksi
layer 11	=	199.7 ksi
layer 12	=	199.7 ksi
layer 13	=	199.7 ksi
layer 14	=	199.7 ksi

OK  
OK  
OK  
OK  
OK  
OK  
OK  
OK  
OK  
OK  
OK  
OK  
OK  
OK

force per strand =  $f_{pe}$  \* strand area

		at midspan	at endspan
layer 1	=	22.8 kips	22.8 kips
layer 2	=	23.2 kips	23.2 kips
layer 3	=	23.2 kips	23.2 kips
layer 4	=	23.2 kips	23.2 kips
layer 5	=	23.5 kips	
layer 6	=	23.5 kips	
layer 7	=	23.5 kips	
layer 8	=	23.5 kips	
layer 9	=		23.5 kips
layer 10	=		23.5 kips
layer 11	=		23.5 kips
layer 12	=		23.5 kips
layer 13	=		23.5 kips
layer 14	=		23.5 kips

Total prestressing force after all losses  $P_{pe}$  =

	at midspan	at endspan
$P_{pe}$ =	1018.3 kips	1019.6 kips

Final losses, % =  $(\Delta f_{pi}) / (f_{pi})$

layer 1	% =	26.7%	26.7%
layer 2	% =	26.6%	26.6%
layer 3	% =	26.6%	26.6%
layer 4	% =	26.5%	26.5%
layer 5	% =	26.5%	
layer 6	% =	26.4%	
layer 7	% =	26.4%	
layer 8	% =	26.4%	
layer 9	% =		26.4%
layer 10	% =		26.4%
layer 11	% =		26.4%
layer 12	% =		26.4%
layer 13	% =		26.4%
layer 14	% =		26.4%
Average final losses, %	% =	26.5%	26.5%

### Stresses at Transfer

#### STRESS LIMITS FOR CONCRETE

Compression = $0.6f_{ci}$	$f_{ci}$ =	3.300 ksi
Tension		
without bonded reinforcement = $-0.0948\sqrt{f_{ci}} \leq -0.2$	=	-0.200 ksi
with bonded auxiliary reinforcement = $-0.22\sqrt{f_{ci}}$	=	-0.016 ksi

#### STRESSES AT TRANSFER LENGTH SECTION

Transfer Length = $60 \times$ (strand diameter)	=	2.5 ft	} Calcs for eccentricity (see 9.6.7.2)
Bending moment at transfer length	$M_g$ =	116.4 ft-kips	
center of 12 strands to top fiber of beam at the end	=	7.00 in	
center of 12 strands to bottom fiber of beam at the harp point	=	11.00 in	
center of 12 strands and top fiber of beam at transfer length	=	10.78 in	
center of gravity of 32 strands and bottom fiber of beam	=	3.88 in	
center of gravity of all strands and the bottom fiber of beam at transfer length	=	19.51 in	
center of gravity of all strands and the bottom fiber of beam at the end	=	20.55 in	
Eccentricity of the strand group at transfer length:	$e_h$ =	18.99 in	
Eccentricity at end of beam:	$e$ =	17.95 in	

$$f_t = \frac{P_i}{A} - \frac{P_i e}{S_t} + \frac{M_g}{S_t}$$

$$f_b = \frac{P_i}{A} + \frac{P_i e}{S_b} - \frac{M_g}{S_b}$$

		at midspan	at endspan
Top stress at top fiber of beam	$f_t$ =	0.181 ksi	0.182 ksi
Bottom stress at bottom fiber of the beam	$f_b$ =	3.146 ksi	3.146 ksi

OK  
OK

STRESSES AT HARP POINT			
Bending moment due to beam weight at 0.3L	$M_g =$	1188.0 ft-kips	
Top stress at top fiber of beam	$f_t =$	-0.097 ksi	-0.097 ksi
Bottom stress at bottom fiber of the beam	$f_b =$	3.438 ksi	3.423 ksi

OK  
NOT OK

STRESSES AT MIDSPAN			
Bending moment due to beam weight at 0.5L	$M_g =$	1414.3 ft-kips	
Top stress at top fiber of beam	$f_t =$	0.075 ksi	0.079 ksi
Bottom stress at bottom fiber of the beam	$f_b =$	3.256 ksi	3.241 ksi

OK  
OK

#### HOLD-DOWN FORCES

assume stress in strand before losses =  $0.8f_u$

layer 1	=	217.0 ksi
layer 2	=	219.2 ksi
layer 3	=	219.2 ksi
layer 4	=	219.2 ksi
layer 5	=	221.4 ksi
layer 6	=	221.4 ksi
layer 7	=	221.4 ksi
layer 8	=	221.4 ksi
layer 9	=	221.4 ksi
layer 10	=	221.4 ksi
layer 11	=	221.4 ksi
layer 12	=	221.4 ksi
layer 13	=	221.4 ksi
layer 14	=	221.4 ksi

prestress force per strand before any losses:

layer 1	=	33.2 kips
layer 2	=	33.5 kips
layer 3	=	33.5 kips
layer 4	=	33.5 kips
layer 5	=	33.9 kips
layer 6	=	33.9 kips
layer 7	=	33.9 kips
layer 8	=	33.9 kips
layer 9	=	33.9 kips
layer 10	=	33.9 kips
layer 11	=	33.9 kips
layer 12	=	33.9 kips
layer 13	=	33.9 kips
layer 14	=	33.9 kips
Harp Angle	$\psi =$	7.2 °

Hold-down force/strand

layer 1	=	4.4 kips/strand
layer 2	=	4.4 kips/strand
layer 3	=	4.4 kips/strand
layer 4	=	4.4 kips/strand
layer 5	=	4.4 kips/strand
layer 6	=	4.4 kips/strand
layer 7	=	4.4 kips/strand
layer 8	=	4.4 kips/strand
layer 9	=	4.4 kips/strand
layer 10	=	4.4 kips/strand
layer 11	=	4.4 kips/strand
layer 12	=	4.4 kips/strand
layer 13	=	4.4 kips/strand
layer 14	=	4.4 kips/strand
Total hold-down force	=	53.21 kips

### Stresses at Service Loads

#### STRESS LIMITS FOR CONCRETE

##### Compression:

Due to permanent loads for load combination Service I

for the precast beam	=	3.056 ksi
for deck	=	1.800 ksi

Due to permanent and transient loads for load combination Service I

for the precast beam	=	4.074 ksi
for deck	=	2.400 ksi

##### Tension:

Load Combination Service III

for the precast beam	=	-0.016 ksi
----------------------	---	------------

#### STRESSES AT MIDSPAN

Compression stresses at top fiber of beam	at midspan	at endspan		
$f_t = \frac{P_{ps}}{A} - \frac{P_{ps}e}{S_t} + \frac{(M_x + M_{s1})}{S_t} + \frac{(M_w + M_b)}{S_{tw}}$				
Due to permanent loads	$f_{tg} =$	1.946 ksi	1.945 ksi	OK
$f_{tr} = \frac{P_{ps}}{A} - \frac{P_{ps}e}{S_t} + \frac{(M_x + M_{s1})}{S_t} + \frac{(M_w - M_b)}{S_{tw}} + \frac{(M_{t2+1})}{S_{tr}}$				
Due to permanent loads and transient loads	$f_{tg} =$	2.362 ksi	2.361 ksi	OK
Compression stresses at top fiber of deck	at midspan	at endspan		
$f_{tc} = \frac{(M_w + M_b)}{S_{tr}}$				
Due to permanent loads	$f_{tc} =$	0.045 ksi	0.045 ksi	OK
$f_{tr} = \frac{(M_w + M_b + M_{t2+1})}{S_{tr}}$				
Due to permanent loads and transient loads	$f_{tc} =$	0.522 ksi	0.522 ksi	OK
Tension stresses at top fiber of deck	at midspan	at endspan		
$f_{tr} = \frac{P_{ps}}{A} + \frac{P_{ps}e}{S_b} - \frac{(M_x + M_{s1})}{S_b} - \frac{(M_w + M_b + 0.8 * M_{t2+1})}{S_{tr}}$				
Load Combination Service III	$f_b =$	-0.557 ksi	-0.552 ksi	OK

### Strength Limit State

#### POSITIVE MOMENT SECTION

$M_u = 1.25DC + 1.5DW + 1.75(LL + IM)$	$M_u =$	8381.5 ft-kips
--	---------	----------------

effective length factor for compression members

layer 1	k =	0.26
layer 2	k =	0.28
layer 3	k =	0.28
layer 4	k =	0.26
layer 5	k =	0.28
layer 6	k =	0.28
layer 7	k =	0.28
layer 8	k =	0.28
layer 9	k =	0.28
layer 10	k =	0.28
layer 11	k =	0.28
layer 12	k =	0.28
layer 13	k =	0.28
layer 14	k =	0.28
c =		5.7 ft-kips

average stress in prestressing steel

layer 1	$f_{ps} =$	265.9 ksi
layer 2	$f_{ps} =$	268.6 ksi
layer 3	$f_{ps} =$	268.6 ksi
layer 4	$f_{ps} =$	268.6 ksi
layer 5	$f_{ps} =$	271.3 ksi
layer 6	$f_{ps} =$	271.3 ksi
layer 7	$f_{ps} =$	271.3 ksi
layer 8	$f_{ps} =$	271.3 ksi
layer 9	$f_{ps} =$	271.3 ksi
layer 10	$f_{ps} =$	271.3 ksi
layer 11	$f_{ps} =$	271.3 ksi
layer 12	$f_{ps} =$	271.3 ksi
layer 13	$f_{ps} =$	271.3 ksi
layer 14	$f_{ps} =$	271.3 ksi

nominal flexure resistance

	$a =$	4.82 in	
$M_r = \Phi M_n, \Phi = 1.00$	$\Phi M_n =$	10802.0 ft-kips	OK
$M = DC+W+LL+IM$	$M =$	5833.6 ft-kips	OK
<b>NEGATIVE MOMENT SECTION</b>			
$M_u = 1.25DC+1.5DW+1.75(LL+IM)$	$M_u =$	4837.2 ft-kips	
	$a =$	5.91 in	
	$\Phi M_n =$	4873.1 ft-kips	OK
$M = DC+W+LL+IM$	$M =$	2869.7 ft-kips	OK

### Shear Design

<b>CRITICAL SECTION AT 0.59</b>			
$V_u = 1.25DC+1.5DW+1.75(LL+IM)$	$V_u =$	405.0 kips	
$M_u = 1.25DC+1.5DW+1.75(LL+IM)$	$M_u =$	-2684.4 ft-kips	
or			
$V_u = 1.25DC+1.5DW+1.75(LL+IM)$	$V_u =$	364.8 kips	
$M_u = 1.25DC+1.5DW+1.75(LL+IM)$	$M_u =$	-2877.0 ft-kips	
max shear	$V_u =$	405.0 kips	
max moment	$M_u =$	2877.0 ft-kips	
Shear depth	$d_v =$	73.19 in	
Applied factored normal force at the section	$N_u =$	0	
Angle of diagonal compressive stresses	$\theta =$	36.00 °	

### STRAIN IN FLEXURAL TENSION REINFORCEMENT

$$\epsilon_s = \frac{\frac{M_u}{d_v} + 0.5N_u + 0.25V_u \cot \theta + A_{ps} f_{ps}}{E_s A_s + E_p A_{ps}} \leq 0.002$$

		<b>at midspan</b>	<b>at endspan</b>
resultant compressive stress at centroid	$f_{pc} =$	0.868 ksi	0.869 ksi

effective stress in prestressing strand after all losses

layer 1	$f_{po} =$	153.8 ksi	153.8 ksi
layer 2	$f_{po} =$	156.0 ksi	156.0 ksi
layer 3	$f_{po} =$	156.0 ksi	156.0 ksi
layer 4	$f_{po} =$	156.2 ksi	156.1 ksi
layer 5	$f_{po} =$	158.2 ksi	
layer 6	$f_{po} =$	158.4 ksi	
layer 7	$f_{po} =$	158.4 ksi	
layer 8	$f_{po} =$	158.4 ksi	
layer 9	$f_{po} =$		158.4 ksi
layer 10	$f_{po} =$		158.4 ksi
layer 11	$f_{po} =$		158.4 ksi
layer 12	$f_{po} =$		158.4 ksi
layer 13	$f_{po} =$		158.4 ksi
layer 14	$f_{po} =$		158.4 ksi



strain in flexural tension

		at midspan	at endspan
layer 1	$\epsilon_x =$	0.002000	0.002000
layer 2	$\epsilon_x =$	0.002000	0.002000
layer 3	$\epsilon_x =$	0.002000	0.002000
layer 4	$\epsilon_x =$	0.002000	0.002000
layer 5	$\epsilon_x =$	0.002000	
layer 6	$\epsilon_x =$	0.002000	
layer 7	$\epsilon_x =$	0.002000	
layer 8	$\epsilon_x =$	0.002000	
layer 9	$\epsilon_x =$		0.002000
layer 10	$\epsilon_x =$		0.002000
layer 11	$\epsilon_x =$		0.002000
layer 12	$\epsilon_x =$		0.002000
layer 13	$\epsilon_x =$		0.002000
layer 14	$\epsilon_x =$		0.002000

### Deflection and Camber

		at midspan	at endspan
Deflection due to Prestressing Force at Transfer	$\Delta_p =$	3.97 in	3.97 in
Deflection due to Beam Self-Weight at Transfer	$\Delta_g =$	-1.66 in	
Deflection due to Beam Self-Weight at Erection	$\Delta_g =$	-1.45 in	
Deflection due to Haunch and Deck	$\Delta_s =$	-2.21 in	
Deflection due to total self weight	$\Delta_{sw} =$	0.31 in	
Total Deflection at transfer	$\Delta =$	2.31 in	2.31 in
Total Deflection at erection	$\Delta =$	4.47 in	4.47 in
Live load deflection limit = span/800	$=$	-1.80 in	
Deflection due to live load and impact	$\Delta_L =$	-0.89 in	
Deflection due to fire truck	$\Delta_L =$	-1.6407 in	
Total Deflection after fire with fire truck	$\Delta =$	2.6409 in	

OK

OK

**Location: Fire at Critical Positive Moment Sections**  
**Beam Design: 1/2" Strand**  
**Fire Exposure Status: 1 Hour**

(PCI Bridge Design Manual Section 9.6)

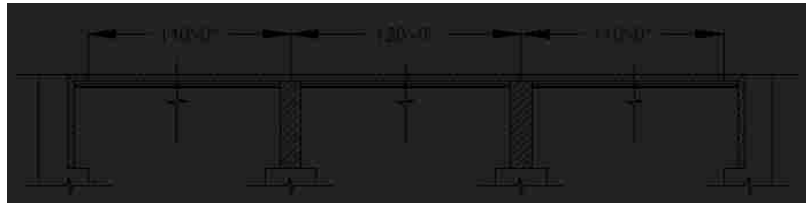


**Material Properties**

CAST-IN-PLACE SLAB			
Actual Thickness	$t_{as} =$		8.0 in
Wearing Surface	$=$		0.5 in
Structural thickness = Actual - Wearing Surface	$t_s =$		7.5 in
Compressive Strength	$f'_c =$		4 ksi
Unit Weight	$w_c =$		150.0 pcf
Stress factor of compression block	$\beta_1 =$		0.85

BEAMS: AASHTO-PCI, BT-72 BULB-TEE			
Strength at release	$f'_{ci} =$		5.5 ksi
Strength at 28 days	$f'_c =$		6.57 ksi
Unit Weight	$w_c =$		150.0 pcf
Overall Beam Length:			
@ end spans	$L =$		110 ft
@ center span	$L =$		119 ft
Design Spans:			
Non-composite beam @ end spans	$L =$		109 ft
Non-composite beam @ center span	$L =$		118 ft
Composite beam @ end spans	$L =$		110 ft
Composite beam @ center span	$L =$		120 ft
Beam Spacing	$S =$		12 ft



**PRESTRESSING STRANDS**

Diameter of single strand	d =	0.5 in
Area of single strand	A =	0.153 in <sup>2</sup>

Temperature of Layer	layer 1 (bottom)	T =	530.00 °F
	layer 2	T =	340.00 °F
	layer 3	T =	280.00 °F
	layer 4	T =	255.00 °F
	layer 5	T =	230.00 °F
	layer 6	T =	205.00 °F
	layer 7	T =	190.00 °F
	layer 8	T =	180.00 °F
	layer 9	T =	68.00 °F
	layer 10	T =	68.00 °F
	layer 11	T =	68.00 °F
	layer 12	T =	68.00 °F
	layer 13	T =	68.00 °F
	layer 14	T =	68.00 °F

Ultimate Strength initial = 277 ksi	layer 1 (bottom)	f <sub>pu</sub> =	263 ksi
	layer 2	f <sub>pu</sub> =	268 ksi
	layer 3	f <sub>pu</sub> =	271 ksi
	layer 4	f <sub>pu</sub> =	271 ksi
	layer 5	f <sub>pu</sub> =	271 ksi
	layer 6	f <sub>pu</sub> =	274 ksi
	layer 7	f <sub>pu</sub> =	274 ksi
	layer 8	f <sub>pu</sub> =	274 ksi
	layer 9	f <sub>pu</sub> =	277 ksi
	layer 10	f <sub>pu</sub> =	277 ksi
	layer 11	f <sub>pu</sub> =	277 ksi
	layer 12	f <sub>pu</sub> =	277 ksi
	layer 13	f <sub>pu</sub> =	277 ksi
	layer 14	f <sub>pu</sub> =	277 ksi

Yield Strength initial = 250 ksi	layer 1 (bottom)	f <sub>py</sub> =	242 ksi
	layer 2	f <sub>py</sub> =	225 ksi
	layer 3	f <sub>py</sub> =	245 ksi
	layer 4	f <sub>py</sub> =	245 ksi
	layer 5	f <sub>py</sub> =	247 ksi
	layer 6	f <sub>py</sub> =	247 ksi
	layer 7	f <sub>py</sub> =	247 ksi
	layer 8	f <sub>py</sub> =	247 ksi
	layer 9	f <sub>py</sub> =	250 ksi
	layer 10	f <sub>py</sub> =	250 ksi
	layer 11	f <sub>py</sub> =	250 ksi
	layer 12	f <sub>py</sub> =	250 ksi
	layer 13	f <sub>py</sub> =	250 ksi
	layer 14	f <sub>py</sub> =	250 ksi

**Stress Limits:**

before transfer  $\leq 0.75f_{pu}$  (initial = 202.5)

layer 1 (bottom)	f <sub>pi</sub> =	197.2 ksi
layer 2	f <sub>pi</sub> =	201.4 ksi
layer 3	f <sub>pi</sub> =	203.4 ksi
layer 4	f <sub>pi</sub> =	203.4 ksi
layer 5	f <sub>pi</sub> =	203.4 ksi
layer 6	f <sub>pi</sub> =	205.5 ksi
layer 7	f <sub>pi</sub> =	205.5 ksi
layer 8	f <sub>pi</sub> =	205.5 ksi
layer 9	f <sub>pi</sub> =	207.6 ksi
layer 10	f <sub>pi</sub> =	207.6 ksi
layer 11	f <sub>pi</sub> =	207.6 ksi
layer 12	f <sub>pi</sub> =	207.6 ksi
layer 13	f <sub>pi</sub> =	207.6 ksi
layer 14	f <sub>pi</sub> =	207.6 ksi

at service limit state (after all losses)  $\leq 0.80f_{py}$  (initial = 194.4)

layer 1 (bottom)	$f_{pe} =$	193.7 ksi
layer 2	$f_{pe} =$	179.7 ksi
layer 3	$f_{pe} =$	195.7 ksi
layer 4	$f_{pe} =$	195.7 ksi
layer 5	$f_{pe} =$	197.7 ksi
layer 6	$f_{pe} =$	197.7 ksi
layer 7	$f_{pe} =$	197.7 ksi
layer 8	$f_{pe} =$	197.7 ksi
layer 9	$f_{pe} =$	199.7 ksi
layer 10	$f_{pe} =$	199.7 ksi
layer 11	$f_{pe} =$	199.7 ksi
layer 12	$f_{pe} =$	199.7 ksi
layer 13	$f_{pe} =$	199.7 ksi
layer 14	$f_{pe} =$	199.7 ksi

Modulus of Elasticity

initial = 25982 ksi

layer 1 (bottom)	E =	27281.1 ksi
layer 2	E =	26761.5 ksi
layer 3	E =	26501.6 ksi
layer 4	E =	26501.6 ksi
layer 5	E =	26501.6 ksi
layer 6	E =	26501.6 ksi
layer 7	E =	26241.8 ksi
layer 8	E =	26241.8 ksi
layer 9	E =	25982.0 ksi
layer 10	E =	25982.0 ksi
layer 11	E =	25982.0 ksi
layer 12	E =	25982.0 ksi
layer 13	E =	25982.0 ksi
layer 14	E =	25982.0 ksi

#### REINFORCING BARS

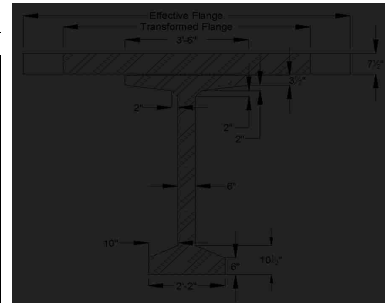
Yield Strength	$f_y =$	57.6 ksi
Modulus of Elasticity	E =	29000.0 ksi

Area of steel at endspan (effective flange)	$A_{se} =$	15.4 in <sup>2</sup>
Area of steel at midspan (effective flange)	$A_{sm} =$	0.0 in <sup>2</sup>
Area of temperature and shrinkage steel (12" width)	$A_s =$	0.0 in <sup>2</sup>

#### Cross-sectional Properties

##### NON-COMPOSITE BEAM

Area of cross-section of beam	A =	767.0 in <sup>2</sup>
Overall depth of beam	H =	72.0 in
Moment of Inertia	I =	440,915 in <sup>4</sup>
Distance from centroid to extreme <b>bottom</b> fiber	$y_b =$	40.3 in
Distance from centroid to extreme <b>top</b> fiber	$y_t =$	31.7 in
Section modulus for the extreme <b>bottom</b> fiber	$S_b =$	14915.0 in <sup>3</sup>
Section modulus for the extreme <b>top</b> fiber	$S_t =$	15421.0 in <sup>3</sup>
Weight	$W_t =$	799.0 plf
Modulus of Elasticity = $33000 \cdot (W_c^{1.5}) \cdot (\sqrt{f_c})$		
cast-in-place concrete deck	$E_{cs} =$	3834 ksi
precast beam at release	$E_{c0} =$	4496 ksi
precast beam at service loads	$E_c =$	4914 ksi



**COMPOSITE BEAM AT MIDSPAN**

Effective Flange Width	$b_f =$	111.0 in	*min of three criteria
Modular Ratio = $E_{cs}/E_c$	$n =$	0.7803	
Transformed flange width	$=$	86.6 in	
Transformed flange area	$=$	649.6 in <sup>2</sup>	
Transformed haunch width	$=$	32.8 in	
Transformed haunch area	$=$	16.4 in <sup>2</sup>	

	Transformed Area	$y_b$	$Ay_b$	$A(y_{bc}-y_b)^2$	I	$I + A(y_{bc}-y_b)^2$
Beam	767.0 in <sup>2</sup>	40.31 in	30,917.8 in <sup>3</sup>	212,814 in <sup>4</sup>	440,915 in <sup>4</sup>	653,729 in <sup>4</sup>
Haunch	16.4 in <sup>2</sup>	72.25 in	1,183.9 in <sup>3</sup>	3,827 in <sup>4</sup>	0.33 in <sup>4</sup>	3,827 in <sup>4</sup>
Deck	649.6 in <sup>2</sup>	76.25 in	49,530.4 in <sup>3</sup>	241,530 in <sup>4</sup>	2,950 in <sup>4</sup>	244,479 in <sup>4</sup>
Total	1433.0 in <sup>2</sup>		81,632.0 in <sup>3</sup>			902,036 in <sup>4</sup>

Total area of Composite Section	$A_c =$	1433 in <sup>2</sup>
Overall Depth of the Composite Section	$h_c =$	80 in
Moment of Inertia	$I_c =$	902,036 in <sup>4</sup>
Distance from centroid to extreme <u>bottom</u> fiber of beam	$y_{bc} =$	56.97 in
Distance from centroid to extreme <u>top</u> fiber of beam	$y_{tb} =$	15.03 in
Distance from centroid to extreme <u>top</u> fiber of slab	$y_{tc} =$	23.03 in
Section modulus for the extreme <u>bottom</u> fiber of beam	$S_{bc} =$	15,834.3 in <sup>3</sup>
Section modulus for the extreme <u>top</u> fiber of beam	$S_{tb} =$	60,004.6 in <sup>3</sup>
Section modulus for the extreme <u>top</u> fiber slab	$S_{tc} =$	50,191.5 in <sup>3</sup>

**Shear Forces and Bending Moments**

**DEAD LOADS**

Beam self-weight	$w_{beam} =$	0.799 k/f
8 in. deck weight	$w_{deck} =$	1.200 k/f
1/2 in. haunch weight	$w_{haunch} =$	0.022 k/f

LRFD Specifications: Art. 4.6.2.2.1

Width of Deck Constant		OK
Number of beams is not less than four $N_b =$	4	OK
Roadway part of the overhang, $d_o \leq 3.0$ ft, $d_o =$	1.5	OK
Curvature in plans is less than $4^\circ =$	0	OK
Cross-section of the bridge is consistent with one of the cross sections given by LRFD specs		OK

Barrier and wearing surface loads are equally distributed among the 4 beams

Barrier Wt	$Wt =$	0.150 k/f
Dead load of future wearing surface	$DW =$	0.263 k/f

**LIVE LOADS**

Fire truck live load front load (Point A)	$P_{live} =$	48.0 kips
Fire truck live load back load (Point B)	$P_{live} =$	22.0 kips
distance between two loads		19.2 ft
distance from nearest edge to point A	$x_a =$	59.0 ft
distance from nearest edge to point B	$x_b =$	39.8 ft

LRFD Specifications: Art. 4.6.2.2.1

Width of Deck Constant		OK
Number of beams is not less than four $N_b =$	4	OK
Beams are parallel and approximately of the same stiffness		OK
Roadway part of the overhang, $d_o \leq 3.0$ ft, $d_o =$	1.5	OK
Curvature in plans is less than $4^\circ =$	0	OK

Barrier and wearing surface loads are equally distributed among the 4 beams

Bridge Type-- "k" (LRFD Table 4.6.2.2.1-1)

Number of design lanes = $w/12$	$=$	3 lanes
---------------------------------	-----	---------

**Distribution Factor for Bending Moment:**

Beams spacing	S =	12.0 ft
Depth of concrete slab	t <sub>s</sub> =	7.5 in
Beam Span	L =	120.0 ft
Number of Beams	N <sub>b</sub> =	4
Modular ratio between beam & deck materials	n =	1.2816
Longitudinal stiffness parameter	K <sub>g</sub> =	2,110,453.24 in <sup>4</sup>

at center span:

$$DFM = 0.75 + \left(\frac{S}{9.5}\right)^{0.4} * \left(\frac{S}{L}\right)^{0.2} * \left(\frac{K_g}{12 * L * t_s^3}\right)^{0.1}$$

DFM =	0.897 lanes/beam
-------	------------------

one design lane loaded:

$$DFM = 0.75 - \left(\frac{S}{14}\right)^{1.4} * \left(\frac{S}{L}\right)^{1.3} * \left(\frac{K_g}{12 * L * t_s^3}\right)^{0.1}$$

DFM =	0.609 lanes/beam
-------	------------------

0.905 Controls

**Distribution Factor for Shear Force**

both end spans and center span:

$$DFV = 0.2 + \left(\frac{S}{12}\right) - \left(\frac{S}{35}\right)^2$$

DFV =	1.082 lanes/beam
-------	------------------

one design lane loaded:

$$DFV = 0.36 + \left(\frac{S}{25}\right)$$

DFV =	0.840 lanes/beam
-------	------------------

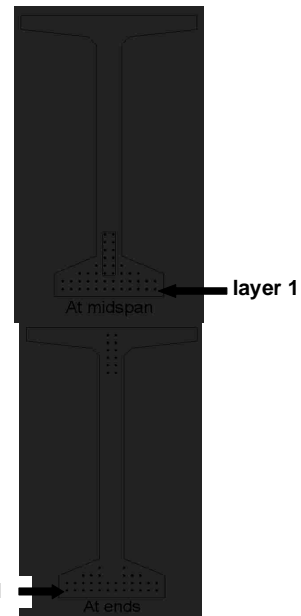
1.082 Controls

from bottom	At Midspan		At Ends	
	No. of	Distance from Bottom	No. of	Distance from Bottom
layer 1	12	2	12	2
layer 2	12	4	12	4
layer 3	8	6	6	6
layer 4	4	8	2	8
layer 5	2	10	-	-
layer 6	2	12	-	-
layer 7	2	14	-	-
layer 8	2	16	-	-
layer 9	-	-	2	60
layer 10	-	-	2	62
layer 11	-	-	2	64
layer 12	-	-	2	66
layer 13	-	-	2	68
layer 14	-	-	2	70
<b>Harped Strand Group (included in above totals)</b>				
layer 3	2	6		
layer 4	2	8		
layer 5	2	10		
layer 6	2	12		
layer 7	2	14		
layer 8	2	16		

distance from the center of gravity of strands to the bottom fiber of the beam = 7% of the beam depth  
strand eccentricity at midspan = (y<sub>c</sub> - y<sub>bs</sub>)

y <sub>bs</sub> =	5.82 in
e <sub>c</sub> =	34.49 in

layer 1



## Prestress Losses

### ELASTIC SHORTENING

assumed loss	=	9.00%
Force per strand at transfer		
layer 1	=	27.5 kips
layer 2	=	28.0 kips
layer 3	=	28.3 kips
layer 4	=	28.3 kips
layer 5	=	28.3 kips
layer 6	=	28.6 kips
layer 7	=	28.6 kips
layer 8	=	28.6 kips
layer 9	=	28.9 kips
layer 10	=	28.9 kips
layer 11	=	28.9 kips
layer 12	=	28.9 kips
layer 13	=	28.9 kips
layer 14	=	28.9 kips

Total prestressing force at release	$P_1 =$	at midspan 1233.8 kips	at endspan 1239.2 kips
Sum of concrete stresses at the center of gravity of prestressing tendons due to prestressing force at transfer and the self-weight of the member at sections of maximum moment	$f_{cgp} =$	3.632 ksi	3.654 ksi
Loss due to shortening		at midspan	at endspan
layer 1	$\Delta f_{pES} =$	22.0 ksi	22.2 ksi
layer 2	$\Delta f_{pES} =$	21.6 ksi	21.7 ksi
layer 3	$\Delta f_{pES} =$	21.4 ksi	21.5 ksi
layer 4	$\Delta f_{pES} =$	21.4 ksi	21.5 ksi
layer 5	$\Delta f_{pES} =$	21.4 ksi	
layer 6	$\Delta f_{pES} =$	21.4 ksi	
layer 7	$\Delta f_{pES} =$	21.2 ksi	
layer 8	$\Delta f_{pES} =$	21.2 ksi	
layer 9	$\Delta f_{pES} =$		21.1 ksi
layer 10	$\Delta f_{pES} =$		21.1 ksi
layer 11	$\Delta f_{pES} =$		21.1 ksi
layer 12	$\Delta f_{pES} =$		21.1 ksi
layer 13	$\Delta f_{pES} =$		21.1 ksi
layer 14	$\Delta f_{pES} =$		21.1 ksi

### SHRINKAGE

Shrinkage = $(17 - 0.15 \cdot \text{Relative Humidity})$	$\Delta f_{pSR} =$	6.5 ksi	← assume relative humidity = 70%
--	--------------------	---------	----------------------------------

### CREEP OF CONCRETE

Change of stresses at center of gravity of prestressing due to permanent loads except the loads acting at time of applying prestressing force, calculated at the same section as $f_{cgp}$	$\Delta f_{cgp} =$	2.133 ksi	
loss due to creep	$\Delta f_{pCR} =$	at midspan 28.7 ksi	at endspan 28.9 ksi

**RELAXATION OF PRESTRESSING STRANDS**

loss due to relaxation after transfer		at midspan	at endspan
layer 1	$\Delta f_{pR2} =$	1.2 ksi	1.2 ksi
layer 2	$\Delta f_{pR2} =$	1.3 ksi	1.3 ksi
layer 3	$\Delta f_{pR2} =$	1.3 ksi	1.3 ksi
layer 4	$\Delta f_{pR2} =$	1.3 ksi	1.3 ksi
layer 5	$\Delta f_{pR2} =$	1.3 ksi	
layer 6	$\Delta f_{pR2} =$	1.3 ksi	
layer 7	$\Delta f_{pR2} =$	1.3 ksi	
layer 8	$\Delta f_{pR2} =$	1.3 ksi	
layer 9	$\Delta f_{pR2} =$		1.4 ksi
layer 10	$\Delta f_{pR2} =$		1.4 ksi
layer 11	$\Delta f_{pR2} =$		1.4 ksi
layer 12	$\Delta f_{pR2} =$		1.4 ksi
layer 13	$\Delta f_{pR2} =$		1.4 ksi
layer 14	$\Delta f_{pR2} =$		1.4 ksi

**TOTAL LOSSES AT TRANSFER**

total loss  $\Delta f_{pES} = \Delta f_{pR}$

stress in tendons after transfer  $f_{pt} = f_{pr} - \Delta f_{pR}$

		at midspan	at endspan
layer 1	$f_{pt} =$	175.2 ksi	175.0 ksi
layer 2	$f_{pt} =$	179.8 ksi	179.6 ksi
layer 3	$f_{pt} =$	182.0 ksi	181.9 ksi
layer 4	$f_{pt} =$	182.0 ksi	181.9 ksi
layer 5	$f_{pt} =$	182.0 ksi	
layer 6	$f_{pt} =$	184.1 ksi	
layer 7	$f_{pt} =$	184.3 ksi	
layer 8	$f_{pt} =$	184.3 ksi	
layer 9	$f_{pt} =$		186.5 ksi
layer 10	$f_{pt} =$		186.5 ksi
layer 11	$f_{pt} =$		186.5 ksi
layer 12	$f_{pt} =$		186.5 ksi
layer 13	$f_{pt} =$		186.5 ksi
layer 14	$f_{pt} =$		186.5 ksi

force per strand =  $f_{pt} \cdot \text{strand area}$

		at midspan	at endspan
layer 1	=	26.8 kips	26.8 kips
layer 2	=	27.5 kips	27.5 kips
layer 3	=	27.9 kips	27.8 kips
layer 4	=	27.9 kips	27.8 kips
layer 5	=	27.9 kips	
layer 6	=	28.2 kips	
layer 7	=	28.2 kips	
layer 8	=	28.2 kips	
layer 9	=		28.5 kips
layer 10	=		28.5 kips
layer 11	=		28.5 kips
layer 12	=		28.5 kips
layer 13	=		28.5 kips
layer 14	=		28.5 kips
Total prestressing force after transfer	$P_1 =$	1211.4 kips	1216.0 kips



Initial loss =  $(\Delta f_p)/(f_{pi})$

		at midspan	at endspan
layer 1	% =	11.2%	11.2%
layer 2	% =	10.7%	10.8%
layer 3	% =	10.5%	10.6%
layer 4	% =	10.5%	10.6%
layer 5	% =	10.5%	
layer 6	% =	10.4%	
layer 7	% =	10.3%	
layer 8	% =	10.3%	
layer 9	% =		10.2%
layer 10	% =		10.2%
layer 11	% =		10.2%
layer 12	% =		10.2%
layer 13	% =		10.2%
layer 14	% =		10.2%

OK  
OK  
OK  
OK  
OK  
OK  
OK  
OK  
OK  
OK  
OK  
OK  
OK

**TOTAL LOSSES AT SERVICE LOADS**

Total Losses		at midspan	at endspan
layer 1	$\Delta f_{pT} =$	58.4 ksi	58.6 ksi
layer 2	$\Delta f_{pT} =$	58.0 ksi	58.1 ksi
layer 3	$\Delta f_{pT} =$	57.8 ksi	57.9 ksi
layer 4	$\Delta f_{pT} =$	57.8 ksi	57.9 ksi
layer 5	$\Delta f_{pT} =$	57.8 ksi	
layer 6	$\Delta f_{pT} =$	57.8 ksi	
layer 7	$\Delta f_{pT} =$	57.6 ksi	
layer 8	$\Delta f_{pT} =$	57.6 ksi	
layer 9	$\Delta f_{pT} =$		57.5 ksi
layer 10	$\Delta f_{pT} =$		57.5 ksi
layer 11	$\Delta f_{pT} =$		57.5 ksi
layer 12	$\Delta f_{pT} =$		57.5 ksi
layer 13	$\Delta f_{pT} =$		57.5 ksi
layer 14	$\Delta f_{pT} =$		57.5 ksi

Stress in tendon after all losses =  $f_{pi} - \Delta f_{pT}$

		at midspan	at endspan
layer 1	$f_{pe} =$	138.8 ksi	138.7 ksi
layer 2	$f_{pe} =$	143.4 ksi	143.2 ksi
layer 3	$f_{pe} =$	145.6 ksi	145.5 ksi
layer 4	$f_{pe} =$	145.6 ksi	145.5 ksi
layer 5	$f_{pe} =$	145.6 ksi	
layer 6	$f_{pe} =$	147.7 ksi	
layer 7	$f_{pe} =$	147.9 ksi	
layer 8	$f_{pe} =$	147.9 ksi	
layer 9	$f_{pe} =$		150.1 ksi
layer 10	$f_{pe} =$		150.1 ksi
layer 11	$f_{pe} =$		150.1 ksi
layer 12	$f_{pe} =$		150.1 ksi
layer 13	$f_{pe} =$		150.1 ksi
layer 14	$f_{pe} =$		150.1 ksi

check prestressing stress limit at service limit state:  $f_{pe} \leq 0.8 \cdot f_{py}$

layer 1	=	193.7 ksi
layer 2	=	179.7 ksi
layer 3	=	195.7 ksi
layer 4	=	195.7 ksi
layer 5	=	197.7 ksi
layer 6	=	197.7 ksi
layer 7	=	197.7 ksi
layer 8	=	197.7 ksi
layer 9	=	199.7 ksi
layer 10	=	199.7 ksi
layer 11	=	199.7 ksi
layer 12	=	199.7 ksi
layer 13	=	199.7 ksi
layer 14	=	199.7 ksi

OK  
OK  
OK  
OK  
OK  
OK  
OK  
OK  
OK  
OK  
OK  
OK  
OK  
OK

force per strand =  $f_{pe}$  \* strand area

		at midspan	at endspan
layer 1	=	21.2 kips	21.2 kips
layer 2	=	21.9 kips	21.9 kips
layer 3	=	22.3 kips	22.3 kips
layer 4	=	22.3 kips	22.3 kips
layer 5	=	22.3 kips	
layer 6	=	22.6 kips	
layer 7	=	22.6 kips	
layer 8	=	22.6 kips	
layer 9	=		23.0 kips
layer 10	=		23.0 kips
layer 11	=		23.0 kips
layer 12	=		23.0 kips
layer 13	=		23.0 kips
layer 14	=		23.0 kips

		at midspan	at endspan
Total prestressing force after all losses	$P_{pe}$ =	965.7 kips	971.2 kips

Final losses, % =  $(\Delta f_{pr}) / (f_{pi})$

layer 1	% =	29.6%	29.7%
layer 2	% =	29.4%	29.5%
layer 3	% =	29.3%	29.4%
layer 4	% =	29.3%	29.4%
layer 5	% =	29.3%	
layer 6	% =	29.3%	
layer 7	% =	29.2%	
layer 8	% =	29.2%	
layer 9	% =		29.2%
layer 10	% =		29.2%
layer 11	% =		29.2%
layer 12	% =		29.2%
layer 13	% =		29.2%
layer 14	% =		29.2%
Average final losses, %	% =	29.3%	29.3%

### Stresses at Transfer

#### STRESS LIMITS FOR CONCRETE

Compression = $0.6f_{ci}$	$f_{ci}$ =	3.300 ksi
Tension		
without bonded reinforcement = $-0.0948\sqrt{f_{ci}} \leq -0.2$	=	-0.200 ksi
with bonded auxiliary reinforcement = $-0.22\sqrt{f_{ci}}$	=	-0.016 ksi

#### STRESSES AT TRANSFER LENGTH SECTION

Transfer Length = $60 \times$ (strand diameter)	=	2.5 ft	} Calcs for eccentricity (see 9.6.7.2)
Bending moment at transfer length	$M_g$ =	116.4 ft-kips	
center of 12 strands to top fiber of beam at the end	=	7.00 in	
center of 12 strands to bottom fiber of beam at the harp point	=	11.00 in	
center of 12 strands and top fiber of beam at transfer length	=	10.78 in	
center of gravity of 32 strands and bottom fiber of beam	=	3.88 in	
center of gravity of all strands and the bottom fiber of beam at transfer length	=	19.51 in	
center of gravity of all strands and the bottom fiber of beam at the end	=	20.55 in	}
Eccentricity of the strand group at transfer length:	$e_n$ =	20.80 in	
Eccentricity at end of beam:	$e$ =	19.76 in	

$$f_t = \frac{P_i}{A} - \frac{P_i e}{S_t} + \frac{M_g}{S_t}$$

$$f_b = \frac{P_i}{A} + \frac{P_i e}{S_b} - \frac{M_g}{S_b}$$

		at midspan	at endspan
Top stress at top fiber of beam	$f_t$ =	0.036 ksi	0.036 ksi
Bottom stress at bottom fiber of the beam	$f_b$ =	3.235 ksi	3.235 ksi

OK  
OK

STRESSES AT HARP POINT			
Bending moment due to beam weight at 0.3L	$M_g =$	1188.0 ft-kips	
Top stress at top fiber of beam	$f_t =$	-0.206 ksi	-0.210 ksi
Bottom stress at bottom fiber of the beam	$f_b =$	3.506 ksi	3.442 ksi

OK  
NOT OK

STRESSES AT MIDSPAN			
Bending moment due to beam weight at 0.5L	$M_g =$	1414.3 ft-kips	
Top stress at top fiber of beam	$f_t =$	-0.050 ksi	-0.034 ksi
Bottom stress at bottom fiber of the beam	$f_b =$	3.324 ksi	3.260 ksi

OK  
NOT OK

#### HOLD-DOWN FORCES

assume stress in strand before losses =  $0.8f_u$

layer 1	=	210.4 ksi
layer 2	=	214.8 ksi
layer 3	=	217.0 ksi
layer 4	=	217.0 ksi
layer 5	=	217.0 ksi
layer 6	=	219.2 ksi
layer 7	=	219.2 ksi
layer 8	=	219.2 ksi
layer 9	=	221.4 ksi
layer 10	=	221.4 ksi
layer 11	=	221.4 ksi
layer 12	=	221.4 ksi
layer 13	=	221.4 ksi
layer 14	=	221.4 ksi

prestress force per strand before any losses:

layer 1	=	32.2 kips
layer 2	=	32.9 kips
layer 3	=	33.2 kips
layer 4	=	33.2 kips
layer 5	=	33.2 kips
layer 6	=	33.5 kips
layer 7	=	33.5 kips
layer 8	=	33.5 kips
layer 9	=	33.9 kips
layer 10	=	33.9 kips
layer 11	=	33.9 kips
layer 12	=	33.9 kips
layer 13	=	33.9 kips
layer 14	=	33.9 kips
Harp Angle	$\psi =$	7.2 °

Hold-down force/strand

layer 1	=	4.2 kips/strand
layer 2	=	4.3 kips/strand
layer 3	=	4.4 kips/strand
layer 4	=	4.4 kips/strand
layer 5	=	4.4 kips/strand
layer 6	=	4.4 kips/strand
layer 7	=	4.4 kips/strand
layer 8	=	4.4 kips/strand
layer 9	=	4.4 kips/strand
layer 10	=	4.4 kips/strand
layer 11	=	4.4 kips/strand
layer 12	=	4.4 kips/strand
layer 13	=	4.4 kips/strand
layer 14	=	4.4 kips/strand
Total hold-down force	=	52.59 kips

### Stresses at Service Loads

#### STRESS LIMITS FOR CONCRETE

##### Compression:

Due to permanent loads for load combination Service I

for the precast beam	=	2.957 ksi
for deck	=	1.800 ksi

Due to permanent and transient loads for load combination Service I

for the precast beam	=	3.942 ksi
for deck	=	2.400 ksi

##### Tension:

Load Combination Service III

for the precast beam	=	-0.015 ksi
----------------------	---	------------

#### STRESSES AT MIDSPAN

Compression stresses at top fiber of beam	at midspan	at endspan		
$f_t = \frac{P_{ps}}{A} - \frac{P_{ps}e}{S_t} + \frac{(M_D + M_{D'})}{S_t} + \frac{(M_{ws} + M_D)}{S_{tw}}$				
Due to permanent loads	$f_{t0} =$	1.877 ksi	1.871 ksi	OK
$f_{tw} = \frac{P_{ps}}{A} - \frac{P_{ps}e}{S_t} + \frac{(M_D + M_{D'})}{S_t} + \frac{(M_{ws} + M_D)}{S_{tw}} + \frac{(M_{LL+I})}{S_{tw}}$				
Due to permanent loads and transient loads	$f_{tw} =$	2.300 ksi	2.294 ksi	OK
Compression stresses at top fiber of deck	at midspan	at endspan		
$f_{tc} = \frac{(M_{ws} + M_D)}{S_{tr}}$				
Due to permanent loads	$f_{tc} =$	0.048 ksi	0.048 ksi	OK
$f_{tw} = \frac{(M_{ws} + M_D + M_{LL+I})}{S_{tr}}$				
Due to permanent loads and transient loads	$f_{tw} =$	0.554 ksi	0.554 ksi	OK
Tension stresses at top fiber of deck	at midspan	at endspan		
$f_{tr} = \frac{P_{ps}}{A} + \frac{P_{ps}e}{S_b} - \frac{(M_D + M_{D'})}{S_b} - \frac{(M_{ws} + M_D + 0.8 * M_{LL+I})}{S_{tr}}$				
Load Combination Service III	$f_b =$	-0.772 ksi	-0.753 ksi	OK

### Strength Limit State

#### POSITIVE MOMENT SECTION

$M_u = 1.25DC + 1.5DW + 1.75(LL+IM)$	$M_u =$	8381.5 ft-kips
--------------------------------------	---------	----------------

effective length factor for compression members

layer 1	k =	0.24
layer 2	k =	0.41
layer 3	k =	0.28
layer 4	k =	0.28
layer 5	k =	0.26
layer 6	k =	0.28
layer 7	k =	0.28
layer 8	k =	0.28
layer 9	k =	0.28
layer 10	k =	0.28
layer 11	k =	0.28
layer 12	k =	0.28
layer 13	k =	0.28
layer 14	k =	0.28
c =		5.6 ft-kips

average stress in prestressing steel

layer 1	$f_{ps} =$	258.3 ksi
layer 2	$f_{ps} =$	263.7 ksi
layer 3	$f_{ps} =$	266.4 ksi
layer 4	$f_{ps} =$	266.4 ksi
layer 5	$f_{ps} =$	266.4 ksi
layer 6	$f_{ps} =$	269.1 ksi
layer 7	$f_{ps} =$	269.1 ksi
layer 8	$f_{ps} =$	269.1 ksi
layer 9	$f_{ps} =$	271.9 ksi
layer 10	$f_{ps} =$	271.9 ksi
layer 11	$f_{ps} =$	271.9 ksi
layer 12	$f_{ps} =$	271.9 ksi
layer 13	$f_{ps} =$	271.9 ksi
layer 14	$f_{ps} =$	271.9 ksi

nominal flexure resistance

$a =$	4.72 in
$\Phi M_n =$	10622.3 ft-kips
$M = DC+W+LL+IM$	5833.6 ft-kips

OK  
OK

**NEGATIVE MOMENT SECTION**

$M_u = 1.25DC+1.5DW+1.75(LL+IM)$	$M_u =$	4837.2 ft-kips
	$a =$	6.11 in
	$\Phi M_n =$	4866.5 ft-kips
$M = DC+W+LL+IM$	$M =$	2869.7 ft-kips

OK  
OK

**Shear Design**

**CRITICAL SECTION AT 0.59**

$V_u = 1.25DC+1.5DW+1.75(LL+IM)$	$V_u =$	405.0 kips
$M_u = 1.25DC+1.5DW+1.75(LL+IM)$	$M_u =$	-2684.4 ft-kips
or		
$V_u = 1.25DC+1.5DW+1.75(LL+IM)$	$V_u =$	364.8 kips
$M_u = 1.25DC+1.5DW+1.75(LL+IM)$	$M_u =$	-2877.0 ft-kips
max shear	$V_u =$	405.0 kips
max moment	$M_u =$	2877.0 ft-kips
Shear depth	$d_v =$	73.19 in
Applied factored normal force at the section	$N_u =$	0
Angle of diagonal compressive stresses	$\theta =$	36.00 °

**STRAIN IN FLEXURAL TENSION REINFORCEMENT**

$$\epsilon_s = \frac{\frac{M_u}{d_v} + 0.5M_u + 0.5M_u \cot \theta}{E_s A_s + E_s A_{ps}} \leq 0.002$$

resultant compressive stress at centroid

	<b>at midspan</b>	<b>at endspan</b>
$f_{pc} =$	0.751 ksi	0.753 ksi

effective stress in prestressing strand after all losses

layer 1	$f_{po} =$	143.0 ksi	142.8 ksi
layer 2	$f_{po} =$	147.4 ksi	147.3 ksi
layer 3	$f_{po} =$	149.7 ksi	149.6 ksi
layer 4	$f_{po} =$	149.7 ksi	149.6 ksi
layer 5	$f_{po} =$	149.7 ksi	
layer 6	$f_{po} =$	151.8 ksi	
layer 7	$f_{po} =$	151.9 ksi	
layer 8	$f_{po} =$	151.9 ksi	
layer 9	$f_{po} =$		154.1 ksi
layer 10	$f_{po} =$		154.1 ksi
layer 11	$f_{po} =$		154.1 ksi
layer 12	$f_{po} =$		154.1 ksi
layer 13	$f_{po} =$		154.1 ksi
layer 14	$f_{po} =$		154.1 ksi

strain in flexural tension

	at midspan	at endspan
layer 1	$\epsilon_x = 0.002000$	0.002000
layer 2	$\epsilon_x = 0.002000$	0.002000
layer 3	$\epsilon_x = 0.002000$	0.002000
layer 4	$\epsilon_x = 0.002000$	0.002000
layer 5	$\epsilon_x = 0.002000$	
layer 6	$\epsilon_x = 0.002000$	
layer 7	$\epsilon_x = 0.002000$	
layer 8	$\epsilon_x = 0.002000$	
layer 9	$\epsilon_x =$	0.002000
layer 10	$\epsilon_x =$	0.002000
layer 11	$\epsilon_x =$	0.002000
layer 12	$\epsilon_x =$	0.002000
layer 13	$\epsilon_x =$	0.002000
layer 14	$\epsilon_x =$	0.002000

### Deflection and Camber

Deflection due to Prestressing Force at Transfer  
 Deflection due to Beam Self-Weight at Transfer  
 Deflection due to Beam Self-Weight at Erection  
 Deflection due to Haunch and Deck

	at midspan	at endspan
$\Delta_p =$	3.97 in	3.97 in
$\Delta_{sw} =$	-1.82 in	
$\Delta_{sw} =$	-1.61 in	
$\Delta_s =$	-2.46 in	

Deflection due to total self weight

$\Delta_{sw} =$	-0.10 in
-----------------	----------

Total Deflection at transfer

$\Delta =$	2.15 in	2.15 in
------------	---------	---------

Total Deflection at erection

$\Delta =$	4.17 in	4.17 in
------------	---------	---------

Live load deflection limit = span/800

$=$	-1.80 in
-----	----------

Deflection due to live load and impact

$\Delta_L =$	-0.99 in
--------------	----------

OK

Deflection due to fire truck

$\Delta_L =$	-1.8262 in
--------------	------------

NOT OK

Total Deflection after fire with fire truck

$\Delta =$	2.0422 in
------------	-----------

**Location: Fire at Critical Positive Moment Sections**  
**Beam Design: 1/2" Strand**  
**Fire Exposure Status: 1-1/2 Hour**

(PCI Bridge Design Manual Section 9.6)

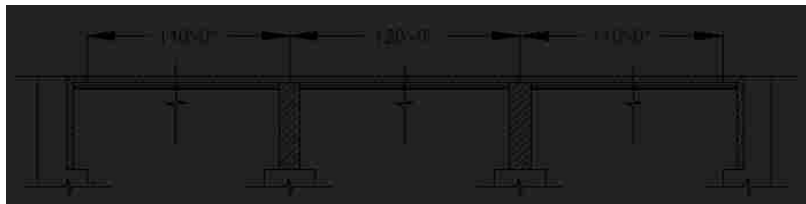


**Material Properties**

CAST-IN-PLACE SLAB			
Actual Thickness	$t_{as} =$		8.0 in
Wearing Surface	$=$		0.5 in
Structural thickness = Actual - Wearing Surface	$t_s =$		7.5 in
Compressive Strength	$f'_c =$		4 ksi
Unit Weight	$w_c =$		150.0 pcf
Stress factor of compression block	$\beta_1 =$		0.85

BEAMS: AASHTO-PCI, BT-72 BULB-TEE			
Strength at release	$f'_{ci} =$		5.5 ksi
Strength at 28 days	$f'_c =$		6.41 ksi
Unit Weight	$w_c =$		150.0 pcf
Overall Beam Length:			
@ end spans	$L =$		110 ft
@ center span	$L =$		119 ft
Design Spans:			
Non-composite beam @ end spans	$L =$		109 ft
Non-composite beam @ center span	$L =$		118 ft
Composite beam @ end spans	$L =$		110 ft
Composite beam @ center span	$L =$		120 ft
Beam Spacing	$S =$		12 ft



**PRESTRESSING STRANDS**

Diameter of single strand	d =	0.5 in
Area of single strand	A =	0.153 in <sup>2</sup>

Temperature of Layer

layer 1 (bottom)	T =	700.00 °F
layer 2	T =	470.00 °F
layer 3	T =	375.00 °F
layer 4	T =	345.00 °F
layer 5	T =	300.00 °F
layer 6	T =	280.00 °F
layer 7	T =	260.00 °F
layer 8	T =	245.00 °F
layer 9	T =	68.00 °F
layer 10	T =	68.00 °F
layer 11	T =	68.00 °F
layer 12	T =	68.00 °F
layer 13	T =	68.00 °F
layer 14	T =	68.00 °F

Ultimate Strength

initial = 277 ksi

layer 1 (bottom)	f <sub>pu</sub> =	249 ksi
layer 2	f <sub>pu</sub> =	266 ksi
layer 3	f <sub>pu</sub> =	268 ksi
layer 4	f <sub>pu</sub> =	268 ksi
layer 5	f <sub>pu</sub> =	271 ksi
layer 6	f <sub>pu</sub> =	271 ksi
layer 7	f <sub>pu</sub> =	271 ksi
layer 8	f <sub>pu</sub> =	271 ksi
layer 9	f <sub>pu</sub> =	277 ksi
layer 10	f <sub>pu</sub> =	277 ksi
layer 11	f <sub>pu</sub> =	277 ksi
layer 12	f <sub>pu</sub> =	277 ksi
layer 13	f <sub>pu</sub> =	277 ksi
layer 14	f <sub>pu</sub> =	277 ksi

Yield Strength

initial = 250 ksi

layer 1 (bottom)	f <sub>py</sub> =	227 ksi
layer 2	f <sub>py</sub> =	245 ksi
layer 3	f <sub>py</sub> =	245 ksi
layer 4	f <sub>py</sub> =	245 ksi
layer 5	f <sub>py</sub> =	247 ksi
layer 6	f <sub>py</sub> =	247 ksi
layer 7	f <sub>py</sub> =	247 ksi
layer 8	f <sub>py</sub> =	247 ksi
layer 9	f <sub>py</sub> =	250 ksi
layer 10	f <sub>py</sub> =	250 ksi
layer 11	f <sub>py</sub> =	250 ksi
layer 12	f <sub>py</sub> =	250 ksi
layer 13	f <sub>py</sub> =	250 ksi
layer 14	f <sub>py</sub> =	250 ksi

**Stress Limits:**

before transfer ≤ 0.75f<sub>pu</sub> (initial = 202.5)

layer 1 (bottom)	f <sub>pl</sub> =	186.8 ksi
layer 2	f <sub>pl</sub> =	199.3 ksi
layer 3	f <sub>pl</sub> =	201.4 ksi
layer 4	f <sub>pl</sub> =	201.4 ksi
layer 5	f <sub>pl</sub> =	203.4 ksi
layer 6	f <sub>pl</sub> =	203.4 ksi
layer 7	f <sub>pl</sub> =	203.4 ksi
layer 8	f <sub>pl</sub> =	203.4 ksi
layer 9	f <sub>pl</sub> =	207.6 ksi
layer 10	f <sub>pl</sub> =	207.6 ksi
layer 11	f <sub>pl</sub> =	207.6 ksi
layer 12	f <sub>pl</sub> =	207.6 ksi
layer 13	f <sub>pl</sub> =	207.6 ksi
layer 14	f <sub>pl</sub> =	207.6 ksi



at service limit state (after all losses)  $\leq 0.80f_{py}$  (initial = 194.4)

layer 1 (bottom)	$f_{pe} =$	181.7 ksi
layer 2	$f_{pe} =$	195.7 ksi
layer 3	$f_{pe} =$	195.7 ksi
layer 4	$f_{pe} =$	195.7 ksi
layer 5	$f_{pe} =$	197.7 ksi
layer 6	$f_{pe} =$	197.7 ksi
layer 7	$f_{pe} =$	197.7 ksi
layer 8	$f_{pe} =$	197.7 ksi
layer 9	$f_{pe} =$	199.7 ksi
layer 10	$f_{pe} =$	199.7 ksi
layer 11	$f_{pe} =$	199.7 ksi
layer 12	$f_{pe} =$	199.7 ksi
layer 13	$f_{pe} =$	199.7 ksi
layer 14	$f_{pe} =$	199.7 ksi

Modulus of Elasticity

initial = 25982 ksi

layer 1 (bottom)	E =	26501.6 ksi
layer 2	E =	27281.1 ksi
layer 3	E =	26761.5 ksi
layer 4	E =	26761.5 ksi
layer 5	E =	26761.5 ksi
layer 6	E =	26501.6 ksi
layer 7	E =	26501.6 ksi
layer 8	E =	26501.6 ksi
layer 9	E =	25982.0 ksi
layer 10	E =	25982.0 ksi
layer 11	E =	25982.0 ksi
layer 12	E =	25982.0 ksi
layer 13	E =	25982.0 ksi
layer 14	E =	25982.0 ksi

#### REINFORCING BARS

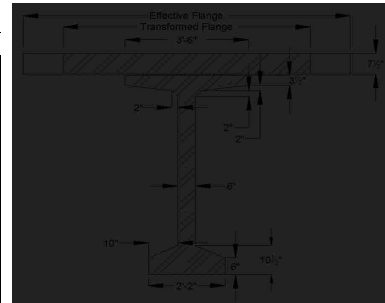
Yield Strength	$f_y =$	57.6 ksi
Modulus of Elasticity	E =	29000.0 ksi

Area of steel at endspan (effective flange)	$A_{se} =$	15.4 in <sup>2</sup>
Area of steel at midspan (effective flange)	$A_{sm} =$	0.0 in <sup>2</sup>
Area of temperature and shrinkage steel (12" width)	$A_s =$	0.0 in <sup>2</sup>

#### Cross-sectional Properties

##### NON-COMPOSITE BEAM

Area of cross-section of beam	A =	767.0 in <sup>2</sup>
Overall depth of beam	H =	72.0 in
Moment of Inertia	I =	412,327 in <sup>4</sup>
Distance from centroid to extreme <b>bottom</b> fiber	$y_b =$	41.5 in
Distance from centroid to extreme <b>top</b> fiber	$y_t =$	30.5 in
Section modulus for the extreme <b>bottom</b> fiber	$S_b =$	14915.0 in <sup>3</sup>
Section modulus for the extreme <b>top</b> fiber	$S_t =$	15421.0 in <sup>3</sup>
Weight	$W_t =$	799.0 plf
Modulus of Elasticity = $33000 \cdot (W_c / 1.5) \cdot (\sqrt{f_c})$		
cast-in-place concrete deck	$E_{cs} =$	3834 ksi
precast beam at release	$E_{c0} =$	4496 ksi
precast beam at service loads	$E_c =$	4854 ksi



**COMPOSITE BEAM AT MIDSPAN**

Effective Flange Width	$b_f =$	111.0 in	*min of three criteria
Modular Ratio = $E_{cs}/E_c$	$n =$	0.7900	
Transformed flange width	$=$	87.7 in	
Transformed flange area	$=$	657.6 in <sup>2</sup>	
Transformed haunch width	$=$	33.2 in	
Transformed haunch area	$=$	16.6 in <sup>2</sup>	

	Transformed Area	$y_b$	$Ay_b$	$A(y_{bc}-y_b)^2$	I	$I + A(y_{bc}-y_b)^2$
Beam	767.0 in <sup>2</sup>	41.52 in	31,845.8 in <sup>3</sup>	201,319 in <sup>4</sup>	412,327 in <sup>4</sup>	613,646 in <sup>4</sup>
Haunch	16.6 in <sup>2</sup>	72.25 in	1,198.6 in <sup>3</sup>	3,502 in <sup>4</sup>	0.33 in <sup>4</sup>	3,502 in <sup>4</sup>
Deck	657.6 in <sup>2</sup>	76.25 in	50,144.7 in <sup>3</sup>	225,779 in <sup>4</sup>	2,950 in <sup>4</sup>	228,728 in <sup>4</sup>
Total	1441.2 in <sup>2</sup>		83,189.1 in <sup>3</sup>			845,877 in <sup>4</sup>

Total area of Composite Section	$A_c =$	1441 in <sup>2</sup>
Overall Depth of the Composite Section	$h_c =$	80 in
Moment of Inertia	$I_c =$	845,877 in <sup>4</sup>
Distance from centroid to extreme <u>bottom</u> fiber of beam	$y_{bc} =$	57.72 in
Distance from centroid to extreme <u>top</u> fiber of beam	$y_{tb} =$	14.28 in
Distance from centroid to extreme <u>top</u> fiber of slab	$y_{lc} =$	22.28 in
Section modulus for the extreme <u>bottom</u> fiber of beam	$S_{bc} =$	14,654.5 in <sup>3</sup>
Section modulus for the extreme <u>top</u> fiber of beam	$S_{tb} =$	59,239.7 in <sup>3</sup>
Section modulus for the extreme <u>top</u> fiber slab	$S_{lc} =$	48,063.2 in <sup>3</sup>

**Shear Forces and Bending Moments**

**DEAD LOADS**

Beam self-weight	$w_{beam} =$	0.799 k/f
8 in. deck weight	$w_{deck} =$	1.200 k/f
1/2 in. haunch weight	$w_{haunch} =$	0.022 k/f

LRFD Specifications: Art. 4.6.2.2.1

Width of Deck Constant		OK
Number of beams is not less than four $N_b =$	4	OK
Roadway part of the overhang, $d_o \leq 3.0$ ft, $d_e =$	1.5	OK
Curvature in plans is less than $4^\circ =$	0	OK
Cross-section of the bridge is consistent with one of the cross sections given by LRFD specs		OK

Barrier and wearing surface loads are equally distributed among the 4 beams

Barrier Wt	$Wt =$	0.150 k/f
Dead load of future wearing surface	$DW =$	0.263 k/f

**LIVE LOADS**

Fire truck live load front load (Point A)	$P_{live} =$	48.0 kips
Fire truck live load back load (Point B)	$P_{live} =$	22.0 kips
distance between two loads		19.2 ft
distance from nearest edge to point A	$x_a =$	59.0 ft
distance from nearest edge to point B	$x_b =$	39.8 ft

LRFD Specifications: Art. 4.6.2.2.1

Width of Deck Constant		OK
Number of beams is not less than four $N_b =$	4	OK
Beams are parallel and approximately of the same stiffness		OK
Roadway part of the overhang, $d_o \leq 3.0$ ft, $d_e =$	1.5	OK
Curvature in plans is less than $4^\circ =$	0	OK

Barrier and wearing surface loads are equally distributed among the 4 beams

Bridge Type-- "k" (LRFD Table 4.6.2.2.1-1)

Number of design lanes = $w/12$	$=$	3 lanes
---------------------------------	-----	---------

**Distribution Factor for Bending Moment:**

Beams spacing	S =	12.0 ft
Depth of concrete slab	t <sub>s</sub> =	7.5 in
Beam Span	L =	120.0 ft
Number of Beams	N <sub>b</sub> =	4
Modular ratio between beam & deck materials	n =	1.2659
Longitudinal stiffness parameter	K <sub>g</sub> =	2,048,407.27 in <sup>4</sup>

at center span:

$$DFM = 0.75 + \left(\frac{S}{9.5}\right)^{0.4} * \left(\frac{S}{L}\right)^{0.3} * \left(\frac{K_g}{12 * L * t_s^3}\right)^{0.1}$$

DFM =	0.895 lanes/beam
-------	------------------

one design lane loaded:

$$DFM = 0.75 - \left(\frac{S}{14}\right)^{1.4} * \left(\frac{S}{L}\right)^{1.3} * \left(\frac{K_g}{12 * L * t_s^3}\right)^{0.1}$$

DFM =	0.607 lanes/beam
-------	------------------

0.905 Controls

**Distribution Factor for Shear Force**

both end spans and center span:

$$DFV = 0.2 + \left(\frac{S}{12}\right) - \left(\frac{S}{35}\right)^2$$

DFV =	1.082 lanes/beam
-------	------------------

one design lane loaded:

$$DFV = 0.36 + \left(\frac{S}{25}\right)$$

DFV =	0.840 lanes/beam
-------	------------------

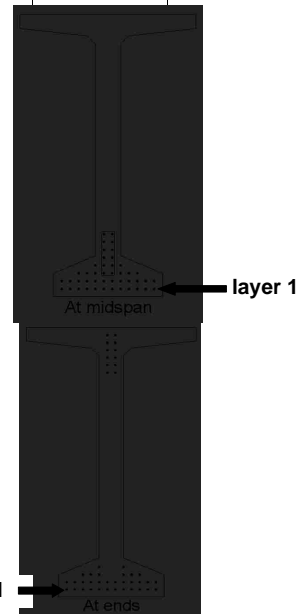
1.082 Controls

from bottom	At Midspan		At Ends	
	No. of	Distance from Bottom	No. of	Distance from Bottom
layer 1	12	2	12	2
layer 2	12	4	12	4
layer 3	8	6	6	6
layer 4	4	8	2	8
layer 5	2	10	-	-
layer 6	2	12	-	-
layer 7	2	14	-	-
layer 8	2	16	-	-
layer 9	-	-	2	60
layer 10	-	-	2	62
layer 11	-	-	2	64
layer 12	-	-	2	66
layer 13	-	-	2	68
layer 14	-	-	2	70
<b>Harped Strand Group (included in above totals)</b>				
layer 3	2	6		
layer 4	2	8		
layer 5	2	10		
layer 6	2	12		
layer 7	2	14		
layer 8	2	16		

distance from the center of gravity of strands to the bottom fiber of the beam = 7% of the beam depth  
strand eccentricity at midspan = (y<sub>c</sub> - y<sub>bs</sub>)

y <sub>bs</sub> =	5.82 in
e <sub>c</sub> =	35.70 in

layer 1



## Prestress Losses

### ELASTIC SHORTENING

assumed loss	=	9.00%
Force per strand at transfer		
layer 1	=	26.0 kips
layer 2	=	27.7 kips
layer 3	=	28.0 kips
layer 4	=	28.0 kips
layer 5	=	28.3 kips
layer 6	=	28.3 kips
layer 7	=	28.3 kips
layer 8	=	28.3 kips
layer 9	=	28.9 kips
layer 10	=	28.9 kips
layer 11	=	28.9 kips
layer 12	=	28.9 kips
layer 13	=	28.9 kips
layer 14	=	28.9 kips

Total prestressing force at release	$P_1 =$	at midspan 1206.8 kips	at endspan 1215.2 kips
Sum of concrete stresses at the center of gravity of prestressing tendons due to prestressing force at transfer and the self-weight of the member at sections of maximum moment	$f_{cgp} =$	3.859 ksi	3.896 ksi
Loss due to shortening		at midspan	at endspan
layer 1	$\Delta f_{pES} =$	22.7 ksi	23.0 ksi
layer 2	$\Delta f_{pES} =$	23.4 ksi	23.6 ksi
layer 3	$\Delta f_{pES} =$	23.0 ksi	23.2 ksi
layer 4	$\Delta f_{pES} =$	23.0 ksi	23.2 ksi
layer 5	$\Delta f_{pES} =$	23.0 ksi	
layer 6	$\Delta f_{pES} =$	22.7 ksi	
layer 7	$\Delta f_{pES} =$	22.7 ksi	
layer 8	$\Delta f_{pES} =$	22.7 ksi	
layer 9	$\Delta f_{pES} =$		22.5 ksi
layer 10	$\Delta f_{pES} =$		22.5 ksi
layer 11	$\Delta f_{pES} =$		22.5 ksi
layer 12	$\Delta f_{pES} =$		22.5 ksi
layer 13	$\Delta f_{pES} =$		22.5 ksi
layer 14	$\Delta f_{pES} =$		22.5 ksi

### SHRINKAGE

Shrinkage = $(17 - 0.15 \cdot \text{Relative Humidity})$	$\Delta f_{pSR} =$	6.5 ksi	← assume relative humidity = 70%
--	--------------------	---------	----------------------------------

### CREEP OF CONCRETE

Change of stresses at center of gravity of prestressing due to permanent loads except the loads acting at time of applying prestressing force, calculated at the same section as $f_{cgp}$	$\Delta f_{cgp} =$	2.358 ksi	
loss due to creep	$\Delta f_{pCR} =$	at midspan 29.8 ksi	at endspan 30.2 ksi

**RELAXATION OF PRESTRESSING STRANDS**

loss due to relaxation after transfer		at midspan	at endspan
layer 1	$\Delta f_{pR2} =$	1.1 ksi	1.1 ksi
layer 2	$\Delta f_{pR2} =$	1.0 ksi	1.0 ksi
layer 3	$\Delta f_{pR2} =$	1.1 ksi	1.0 ksi
layer 4	$\Delta f_{pR2} =$	1.1 ksi	1.0 ksi
layer 5	$\Delta f_{pR2} =$	1.1 ksi	
layer 6	$\Delta f_{pR2} =$	1.1 ksi	
layer 7	$\Delta f_{pR2} =$	1.1 ksi	
layer 8	$\Delta f_{pR2} =$	1.1 ksi	
layer 9	$\Delta f_{pR2} =$		1.1 ksi
layer 10	$\Delta f_{pR2} =$		1.1 ksi
layer 11	$\Delta f_{pR2} =$		1.1 ksi
layer 12	$\Delta f_{pR2} =$		1.1 ksi
layer 13	$\Delta f_{pR2} =$		1.1 ksi
layer 14	$\Delta f_{pR2} =$		1.1 ksi

**TOTAL LOSSES AT TRANSFER**

total loss  $\Delta f_{pES} = \Delta f_{pt}$

stress in tendons after transfer  $f_{pt} = f_{pr} - \Delta f_{pt}$

		at midspan	at endspan
layer 1	$f_{pt} =$	164.1 ksi	163.9 ksi
layer 2	$f_{pt} =$	175.9 ksi	175.7 ksi
layer 3	$f_{pt} =$	178.4 ksi	178.2 ksi
layer 4	$f_{pt} =$	178.4 ksi	178.2 ksi
layer 5	$f_{pt} =$	180.5 ksi	
layer 6	$f_{pt} =$	180.7 ksi	
layer 7	$f_{pt} =$	180.7 ksi	
layer 8	$f_{pt} =$	180.7 ksi	
layer 9	$f_{pt} =$		185.1 ksi
layer 10	$f_{pt} =$		185.1 ksi
layer 11	$f_{pt} =$		185.1 ksi
layer 12	$f_{pt} =$		185.1 ksi
layer 13	$f_{pt} =$		185.1 ksi
layer 14	$f_{pt} =$		185.1 ksi

force per strand =  $f_{pt} \cdot \text{strand area}$

		at midspan	at endspan
layer 1	=	25.1 kips	25.1 kips
layer 2	=	26.9 kips	26.9 kips
layer 3	=	27.3 kips	27.3 kips
layer 4	=	27.3 kips	27.3 kips
layer 5	=	27.6 kips	
layer 6	=	27.6 kips	
layer 7	=	27.6 kips	
layer 8	=	27.6 kips	
layer 9	=		28.3 kips
layer 10	=		28.3 kips
layer 11	=		28.3 kips
layer 12	=		28.3 kips
layer 13	=		28.3 kips
layer 14	=		28.3 kips
Total prestressing force after transfer	$P_1 =$	1172.4 kips	1182.0 kips

Initial loss =  $(\Delta f_p)/(f_{pi})$

		at midspan	at endspan
layer 1	% =	12.2%	12.3%
layer 2	% =	11.7%	11.9%
layer 3	% =	11.4%	11.5%
layer 4	% =	11.4%	11.5%
layer 5	% =	11.3%	
layer 6	% =	11.2%	
layer 7	% =	11.2%	
layer 8	% =	11.2%	
layer 9	% =		10.8%
layer 10	% =		10.8%
layer 11	% =		10.8%
layer 12	% =		10.8%
layer 13	% =		10.8%
layer 14	% =		10.8%

OK  
OK  
OK  
OK  
OK  
OK  
OK  
OK  
OK  
OK  
OK  
OK  
OK

**TOTAL LOSSES AT SERVICE LOADS**

Total Losses		at midspan	at endspan
layer 1	$\Delta f_{pT} =$	60.1 ksi	60.4 ksi
layer 2	$\Delta f_{pT} =$	60.8 ksi	61.0 ksi
layer 3	$\Delta f_{pT} =$	60.4 ksi	60.6 ksi
layer 4	$\Delta f_{pT} =$	60.4 ksi	60.6 ksi
layer 5	$\Delta f_{pT} =$	60.4 ksi	
layer 6	$\Delta f_{pT} =$	60.1 ksi	
layer 7	$\Delta f_{pT} =$	60.1 ksi	
layer 8	$\Delta f_{pT} =$	60.1 ksi	
layer 9	$\Delta f_{pT} =$		59.9 ksi
layer 10	$\Delta f_{pT} =$		59.9 ksi
layer 11	$\Delta f_{pT} =$		59.9 ksi
layer 12	$\Delta f_{pT} =$		59.9 ksi
layer 13	$\Delta f_{pT} =$		59.9 ksi
layer 14	$\Delta f_{pT} =$		59.9 ksi

Stress in tendon after all losses =  $f_{pi} - \Delta f_{pt}$

		at midspan	at endspan
layer 1	$f_{pe} =$	126.7 ksi	126.5 ksi
layer 2	$f_{pe} =$	138.5 ksi	138.3 ksi
layer 3	$f_{pe} =$	141.0 ksi	140.8 ksi
layer 4	$f_{pe} =$	141.0 ksi	140.8 ksi
layer 5	$f_{pe} =$	143.1 ksi	
layer 6	$f_{pe} =$	143.3 ksi	
layer 7	$f_{pe} =$	143.3 ksi	
layer 8	$f_{pe} =$	143.3 ksi	
layer 9	$f_{pe} =$		147.7 ksi
layer 10	$f_{pe} =$		147.7 ksi
layer 11	$f_{pe} =$		147.7 ksi
layer 12	$f_{pe} =$		147.7 ksi
layer 13	$f_{pe} =$		147.7 ksi
layer 14	$f_{pe} =$		147.7 ksi

check prestressing stress limit at service limit state:  $f_{pe} \leq 0.8 \cdot f_{py}$

layer 1	=	181.7 ksi
layer 2	=	195.7 ksi
layer 3	=	195.7 ksi
layer 4	=	195.7 ksi
layer 5	=	197.7 ksi
layer 6	=	197.7 ksi
layer 7	=	197.7 ksi
layer 8	=	197.7 ksi
layer 9	=	199.7 ksi
layer 10	=	199.7 ksi
layer 11	=	199.7 ksi
layer 12	=	199.7 ksi
layer 13	=	199.7 ksi
layer 14	=	199.7 ksi

OK  
OK  
OK  
OK  
OK  
OK  
OK  
OK  
OK  
OK  
OK  
OK  
OK  
OK

force per strand =  $f_{pe}$  \* strand area

		at midspan	at endspan
layer 1	=	19.4 kips	19.4 kips
layer 2	=	21.2 kips	21.2 kips
layer 3	=	21.6 kips	21.5 kips
layer 4	=	21.6 kips	21.5 kips
layer 5	=	21.9 kips	
layer 6	=	21.9 kips	
layer 7	=	21.9 kips	
layer 8	=	21.9 kips	
layer 9	=		22.6 kips
layer 10	=		22.6 kips
layer 11	=		22.6 kips
layer 12	=		22.6 kips
layer 13	=		22.6 kips
layer 14	=		22.6 kips

Total prestressing force after all losses  $P_{pe}$  =  
 Final losses, % =  $(\Delta f_{pr}) / (f_{pi})$

		at midspan	at endspan
$P_{pe}$ =		921.1 kips	929.6 kips
layer 1	% =	32.2%	32.3%
layer 2	% =	32.5%	32.7%
layer 3	% =	32.3%	32.4%
layer 4	% =	32.3%	32.4%
layer 5	% =	32.3%	
layer 6	% =	32.2%	
layer 7	% =	32.2%	
layer 8	% =	32.2%	
layer 9	% =		32.1%
layer 10	% =		32.1%
layer 11	% =		32.1%
layer 12	% =		32.1%
layer 13	% =		32.1%
layer 14	% =		32.1%
Average final losses, %	% =	32.3%	32.2%

### Stresses at Transfer

#### STRESS LIMITS FOR CONCRETE

Compression = $0.6f_{ci}$	$f_{ci}$ =	3.300 ksi
Tension		
without bonded reinforcement = $-0.0948\sqrt{f_{ci}} \leq -0.2$	=	-0.200 ksi
with bonded auxiliary reinforcement = $-0.22\sqrt{f_{ci}}$	=	-0.016 ksi

#### STRESSES AT TRANSFER LENGTH SECTION

Transfer Length = $60 \times$ (strand diameter)	=	2.5 ft	} Calcs for eccentricity (see 9.6.7.2)
Bending moment at transfer length	$M_g$ =	116.4 ft-kips	
center of 12 strands to top fiber of beam at the end	=	7.00 in	
center of 12 strands to bottom fiber of beam at the harp point	=	11.00 in	
center of 12 strands and top fiber of beam at transfer length	=	10.78 in	
center of gravity of 32 strands and bottom fiber of beam	=	3.88 in	
center of gravity of all strands and the bottom fiber of beam at transfer length	=	19.51 in	
center of gravity of all strands and the bottom fiber of beam at the end	=	20.55 in	
Eccentricity of the strand group at transfer length:	$e_n$ =	22.01 in	
Eccentricity at end of beam:	$e$ =	20.97 in	

$$f_t = \frac{P_i}{A} - \frac{P_i e}{S_t} + \frac{M_g}{S_t}$$

$$f_b = \frac{P_i}{A} + \frac{P_i e}{S_b} - \frac{M_g}{S_b}$$

		at midspan	at endspan
Top stress at top fiber of beam	$f_t$ =	-0.054 ksi	-0.055 ksi
Bottom stress at bottom fiber of the beam	$f_b$ =	3.260 ksi	3.260 ksi

OK  
OK

STRESSES AT HARP POINT			
Bending moment due to beam weight at 0.3L	$M_g =$	1188.0 ft-kips	
Top stress at top fiber of beam	$f_t =$	-0.261 ksi	-0.271 ksi
Bottom stress at bottom fiber of the beam	$f_b =$	3.506 ksi	3.415 ksi

OK  
NOT OK

STRESSES AT MIDSPAN			
Bending moment due to beam weight at 0.5L	$M_g =$	1414.3 ft-kips	
Top stress at top fiber of beam	$f_t =$	-0.120 ksi	-0.095 ksi
Bottom stress at bottom fiber of the beam	$f_b =$	3.324 ksi	3.232 ksi

OK  
NOT OK

#### HOLD-DOWN FORCES

assume stress in strand before losses =  $0.8f_u$

layer 1	=	199.3 ksi
layer 2	=	212.6 ksi
layer 3	=	214.8 ksi
layer 4	=	214.8 ksi
layer 5	=	217.0 ksi
layer 6	=	217.0 ksi
layer 7	=	217.0 ksi
layer 8	=	217.0 ksi
layer 9	=	221.4 ksi
layer 10	=	221.4 ksi
layer 11	=	221.4 ksi
layer 12	=	221.4 ksi
layer 13	=	221.4 ksi
layer 14	=	221.4 ksi

prestress force per strand before any losses:

layer 1	=	30.5 kips
layer 2	=	32.5 kips
layer 3	=	32.9 kips
layer 4	=	32.9 kips
layer 5	=	33.2 kips
layer 6	=	33.2 kips
layer 7	=	33.2 kips
layer 8	=	33.2 kips
layer 9	=	33.9 kips
layer 10	=	33.9 kips
layer 11	=	33.9 kips
layer 12	=	33.9 kips
layer 13	=	33.9 kips
layer 14	=	33.9 kips
Harp Angle	$\psi =$	7.2 °

Hold-down force/strand

layer 1	=	4.0 kips/strand
layer 2	=	4.3 kips/strand
layer 3	=	4.3 kips/strand
layer 4	=	4.3 kips/strand
layer 5	=	4.4 kips/strand
layer 6	=	4.4 kips/strand
layer 7	=	4.4 kips/strand
layer 8	=	4.4 kips/strand
layer 9	=	4.4 kips/strand
layer 10	=	4.4 kips/strand
layer 11	=	4.4 kips/strand
layer 12	=	4.4 kips/strand
layer 13	=	4.4 kips/strand
layer 14	=	4.4 kips/strand
Total hold-down force	=	52.14 kips



### Stresses at Service Loads

#### STRESS LIMITS FOR CONCRETE

##### Compression:

Due to permanent loads for load combination Service I

for the precast beam	=	2.885 ksi
for deck	=	1.800 ksi

Due to permanent and transient loads for load combination Service I

for the precast beam	=	3.846 ksi
for deck	=	2.400 ksi

##### Tension:

Load Combination Service III

for the precast beam	=	-0.015 ksi
----------------------	---	------------

#### STRESSES AT MIDSPAN

Compression stresses at top fiber of beam	at midspan	at endspan		
$f_t = \frac{P_{ps}}{A} - \frac{P_{ps}e}{S_t} + \frac{(M_D + M_{D'})}{S_t} + \frac{(M_{ws} + M_D)}{S_{tr}}$				
Due to permanent loads	$f_{t0} =$	1.846 ksi	1.838 ksi	OK
$f_{t0} = \frac{P_{ps}}{A} - \frac{P_{ps}e}{S_t} + \frac{(M_D + M_{D'})}{S_t} + \frac{(M_{ws} + M_D)}{S_{tr}} + \frac{(M_{DL1})}{S_{tr}}$				
Due to permanent loads and transient loads	$f_{t0} =$	2.275 ksi	2.266 ksi	OK
Compression stresses at top fiber of deck	at midspan	at endspan		
$f_{t0} = \frac{(M_{ws} + M_D)}{S_{tr}}$				
Due to permanent loads	$f_{t0} =$	0.050 ksi	0.050 ksi	OK
$f_{t0} = \frac{(M_{ws} + M_D + M_{DL1})}{S_{tr}}$				
Due to permanent loads and transient loads	$f_{t0} =$	0.578 ksi	0.578 ksi	OK
Tension stresses at top fiber of deck	at midspan	at endspan		
$f_{t0} = \frac{P_{ps}}{A} + \frac{P_{ps}e}{S_b} - \frac{(M_D + M_{D'})}{S_b} - \frac{(M_{ws} + M_D + 0.8 * M_{DL1})}{S_{tr}}$				
Load Combination Service III	$f_{t0} =$	-0.974 ksi	-0.943 ksi	OK

### Strength Limit State

#### POSITIVE MOMENT SECTION

$M_0 = 1.25DC + 1.5DW + 1.75(LL + IM)$	$M_0 =$	8381.5 ft-kips
--	---------	----------------

effective length factor for compression members

layer 1	k =	0.26
layer 2	k =	0.24
layer 3	k =	0.26
layer 4	k =	0.26
layer 5	k =	0.26
layer 6	k =	0.26
layer 7	k =	0.26
layer 8	k =	0.26
layer 9	k =	0.28
layer 10	k =	0.28
layer 11	k =	0.28
layer 12	k =	0.28
layer 13	k =	0.28
layer 14	k =	0.28
c =		5.5 ft-kips

average stress in prestressing steel

layer 1	$f_{ps} =$	244.4 ksi
layer 2	$f_{ps} =$	260.7 ksi
layer 3	$f_{ps} =$	263.4 ksi
layer 4	$f_{ps} =$	263.4 ksi
layer 5	$f_{ps} =$	266.1 ksi
layer 6	$f_{ps} =$	266.1 ksi
layer 7	$f_{ps} =$	266.1 ksi
layer 8	$f_{ps} =$	266.1 ksi
layer 9	$f_{ps} =$	271.6 ksi
layer 10	$f_{ps} =$	271.6 ksi
layer 11	$f_{ps} =$	271.6 ksi
layer 12	$f_{ps} =$	271.6 ksi
layer 13	$f_{ps} =$	271.6 ksi
layer 14	$f_{ps} =$	271.6 ksi

nominal flexure resistance

$a =$	4.64 in
$\Phi M_n =$	10386.7 ft-kips
$M = DC+W+LL+IM$	5833.6 ft-kips

OK  
OK

**NEGATIVE MOMENT SECTION**

$M_u = 1.25DC+1.5DW+1.75(LL+IM)$	$M_u =$	4837.2 ft-kips
	$a =$	6.26 in
	$\Phi M_n =$	4861.4 ft-kips
$M = DC+W+LL+IM$	$M =$	2869.7 ft-kips

OK  
OK

**Shear Design**

**CRITICAL SECTION AT 0.59**

$V_u = 1.25DC+1.5DW+1.75(LL+IM)$	$V_u =$	405.0 kips
$M_u = 1.25DC+1.5DW+1.75(LL+IM)$	$M_u =$	-2684.4 ft-kips
or		
$V_u = 1.25DC+1.5DW+1.75(LL+IM)$	$V_u =$	364.8 kips
$M_u = 1.25DC+1.5DW+1.75(LL+IM)$	$M_u =$	-2877.0 ft-kips
max shear	$V_u =$	405.0 kips
max moment	$M_u =$	2877.0 ft-kips
Shear depth	$d_v =$	73.19 in
Applied factored normal force at the section	$N_u =$	0
Angle of diagonal compressive stresses	$\theta =$	36.00 °

**STRAIN IN FLEXURAL TENSION REINFORCEMENT**

$$\epsilon_s = \frac{\frac{M_u}{S_x} + 0.5M_u + 0.5M_u \cot \theta + A_{ps} f_{pr}}{E_s A_s + E_s A_{ps}} \leq 0.002$$

	<b>at midspan</b>	<b>at endspan</b>
resultant compressive stress at centroid	$f_{pc} =$	0.668 ksi
effective stress in prestressing strand after all losses		0.671 ksi

layer 1	$f_{po} =$	130.3 ksi	130.1 ksi
layer 2	$f_{po} =$	142.2 ksi	142.0 ksi
layer 3	$f_{po} =$	144.7 ksi	144.5 ksi
layer 4	$f_{po} =$	144.7 ksi	144.5 ksi
layer 5	$f_{po} =$	146.8 ksi	
layer 6	$f_{po} =$	147.0 ksi	
layer 7	$f_{po} =$	147.0 ksi	
layer 8	$f_{po} =$	147.0 ksi	
layer 9	$f_{po} =$		151.3 ksi
layer 10	$f_{po} =$		151.3 ksi
layer 11	$f_{po} =$		151.3 ksi
layer 12	$f_{po} =$		151.3 ksi
layer 13	$f_{po} =$		151.3 ksi
layer 14	$f_{po} =$		151.3 ksi

strain in flexural tension

	at midspan	at endspan
layer 1	$\epsilon_x = 0.002000$	0.002000
layer 2	$\epsilon_x = 0.002000$	0.002000
layer 3	$\epsilon_x = 0.002000$	0.002000
layer 4	$\epsilon_x = 0.002000$	0.002000
layer 5	$\epsilon_x = 0.002000$	
layer 6	$\epsilon_x = 0.002000$	
layer 7	$\epsilon_x = 0.002000$	
layer 8	$\epsilon_x = 0.002000$	
layer 9	$\epsilon_x =$	0.002000
layer 10	$\epsilon_x =$	0.002000
layer 11	$\epsilon_x =$	0.002000
layer 12	$\epsilon_x =$	0.002000
layer 13	$\epsilon_x =$	0.002000
layer 14	$\epsilon_x =$	0.002000

### Deflection and Camber

Deflection due to Prestressing Force at Transfer  
 Deflection due to Beam Self-Weight at Transfer  
 Deflection due to Beam Self-Weight at Erection  
 Deflection due to Haunch and Deck

	at midspan	at endspan
$\Delta_p =$	3.97 in	3.97 in
$\Delta_{sw} =$	-1.94 in	
$\Delta_{sw} =$	-1.74 in	
$\Delta_s =$	-2.66 in	

Deflection due to total self weight

$\Delta_{sw} =$	-0.44 in
-----------------	----------

Total Deflection at transfer

$\Delta =$	2.02 in	2.02 in
------------	---------	---------

Total Deflection at erection

$\Delta =$	3.92 in	3.92 in
------------	---------	---------

Live load deflection limit = span/800

$=$	-1.80 in
-----	----------

Deflection due to live load and impact

$\Delta_L =$	-1.07 in
--------------	----------

OK

Deflection due to fire truck

$\Delta_L =$	-1.9771 in
--------------	------------

NOT OK

Total Deflection after fire with fire truck

$\Delta =$	1.5553 in
------------	-----------

**Location: Fire at Critical Positive Moment Sections**  
**Beam Design: 1/2" Strand**  
**Fire Exposure Status: 2 Hour**

(PCI Bridge Design Manual Section 9.6)

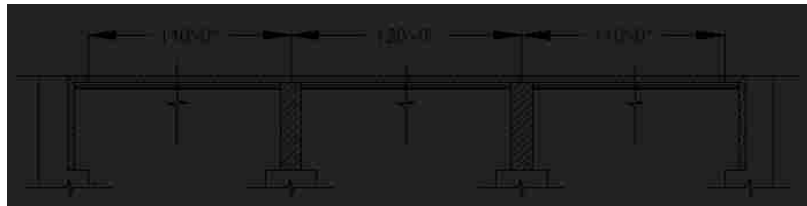


**Material Properties**

CAST-IN-PLACE SLAB			
Actual Thickness	$t_{as} =$		8.0 in
Wearing Surface	$=$		0.5 in
Structural thickness = Actual - Wearing Surface	$t_s =$		7.5 in
Compressive Strength	$f'_c =$		4 ksi
Unit Weight	$w_c =$		150.0 pcf
Stress factor of compression block	$\beta_1 =$		0.85

BEAMS: AASHTO-PCI, BT-72 BULB-TEE			
Strength at release	$f_{ci} =$		5.5 ksi
Strength at 28 days	$f'_c =$		6.17 ksi
Unit Weight	$w_c =$		150.0 pcf
Overall Beam Length:			
@ end spans	$L =$		110 ft
@ center span	$L =$		119 ft
Design Spans:			
Non-composite beam @ end spans	$L =$		109 ft
Non-composite beam @ center span	$L =$		118 ft
Composite beam @ end spans	$L =$		110 ft
Composite beam @ center span	$L =$		120 ft
Beam Spacing	$S =$		12 ft



**PRESTRESSING STRANDS**

Diameter of single strand	d =	0.5 in
Area of single strand	A =	0.153 in <sup>2</sup>

Temperature of Layer

layer 1 (bottom)	T =	870.00 °F
layer 2	T =	630.00 °F
layer 3	T =	495.00 °F
layer 4	T =	470.00 °F
layer 5	T =	440.00 °F
layer 6	T =	400.00 °F
layer 7	T =	375.00 °F
layer 8	T =	350.00 °F
layer 9	T =	68.00 °F
layer 10	T =	68.00 °F
layer 11	T =	68.00 °F
layer 12	T =	68.00 °F
layer 13	T =	68.00 °F
layer 14	T =	68.00 °F

Ultimate Strength

initial = 277 ksi

layer 1 (bottom)	f <sub>pu</sub> =	224 ksi
layer 2	f <sub>pu</sub> =	255 ksi
layer 3	f <sub>pu</sub> =	266 ksi
layer 4	f <sub>pu</sub> =	266 ksi
layer 5	f <sub>pu</sub> =	266 ksi
layer 6	f <sub>pu</sub> =	268 ksi
layer 7	f <sub>pu</sub> =	268 ksi
layer 8	f <sub>pu</sub> =	268 ksi
layer 9	f <sub>pu</sub> =	277 ksi
layer 10	f <sub>pu</sub> =	277 ksi
layer 11	f <sub>pu</sub> =	277 ksi
layer 12	f <sub>pu</sub> =	277 ksi
layer 13	f <sub>pu</sub> =	277 ksi
layer 14	f <sub>pu</sub> =	277 ksi

Yield Strength

initial = 250 ksi

layer 1 (bottom)	f <sub>py</sub> =	202 ksi
layer 2	f <sub>py</sub> =	232 ksi
layer 3	f <sub>py</sub> =	245 ksi
layer 4	f <sub>py</sub> =	245 ksi
layer 5	f <sub>py</sub> =	245 ksi
layer 6	f <sub>py</sub> =	245 ksi
layer 7	f <sub>py</sub> =	245 ksi
layer 8	f <sub>py</sub> =	247 ksi
layer 9	f <sub>py</sub> =	250 ksi
layer 10	f <sub>py</sub> =	250 ksi
layer 11	f <sub>py</sub> =	250 ksi
layer 12	f <sub>py</sub> =	250 ksi
layer 13	f <sub>py</sub> =	250 ksi
layer 14	f <sub>py</sub> =	250 ksi

**Stress Limits:**

before transfer ≤ 0.75f<sub>pu</sub> (initial = 202.5)

layer 1 (bottom)	f <sub>pl</sub> =	168.2 ksi
layer 2	f <sub>pl</sub> =	191.0 ksi
layer 3	f <sub>pl</sub> =	199.3 ksi
layer 4	f <sub>pl</sub> =	199.3 ksi
layer 5	f <sub>pl</sub> =	199.3 ksi
layer 6	f <sub>pl</sub> =	201.4 ksi
layer 7	f <sub>pl</sub> =	201.4 ksi
layer 8	f <sub>pl</sub> =	201.4 ksi
layer 9	f <sub>pl</sub> =	207.6 ksi
layer 10	f <sub>pl</sub> =	207.6 ksi
layer 11	f <sub>pl</sub> =	207.6 ksi
layer 12	f <sub>pl</sub> =	207.6 ksi
layer 13	f <sub>pl</sub> =	207.6 ksi
layer 14	f <sub>pl</sub> =	207.6 ksi

at service limit state (after all losses)  $\leq 0.80f_{py}$  (initial = 194.4)

layer 1 (bottom)	$f_{pe} =$	161.7 ksi
layer 2	$f_{pe} =$	185.7 ksi
layer 3	$f_{pe} =$	195.7 ksi
layer 4	$f_{pe} =$	195.7 ksi
layer 5	$f_{pe} =$	195.7 ksi
layer 6	$f_{pe} =$	195.7 ksi
layer 7	$f_{pe} =$	195.7 ksi
layer 8	$f_{pe} =$	197.7 ksi
layer 9	$f_{pe} =$	199.7 ksi
layer 10	$f_{pe} =$	199.7 ksi
layer 11	$f_{pe} =$	199.7 ksi
layer 12	$f_{pe} =$	199.7 ksi
layer 13	$f_{pe} =$	199.7 ksi
layer 14	$f_{pe} =$	199.7 ksi

Modulus of Elasticity

initial = 25982 ksi

layer 1 (bottom)	E =	26241.8 ksi
layer 2	E =	26761.5 ksi
layer 3	E =	27281.1 ksi
layer 4	E =	27281.1 ksi
layer 5	E =	27021.3 ksi
layer 6	E =	27021.3 ksi
layer 7	E =	26761.5 ksi
layer 8	E =	26761.5 ksi
layer 9	E =	25982.0 ksi
layer 10	E =	25982.0 ksi
layer 11	E =	25982.0 ksi
layer 12	E =	25982.0 ksi
layer 13	E =	25982.0 ksi
layer 14	E =	25982.0 ksi

#### REINFORCING BARS

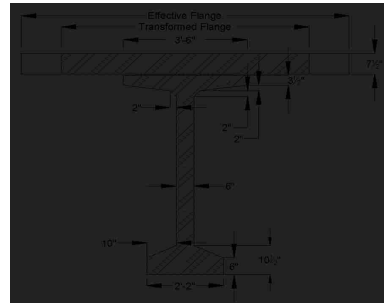
Yield Strength	$f_y =$	57.6 ksi
Modulus of Elasticity	E =	29000.0 ksi

Area of steel at endspan (effective flange)	$A_{se} =$	15.4 in <sup>2</sup>
Area of steel at midspan (effective flange)	$A_{sm} =$	0.0 in <sup>2</sup>
Area of temperature and shrinkage steel (12" width)	$A_s =$	0.0 in <sup>2</sup>

#### Cross-sectional Properties

##### NON-COMPOSITE BEAM

Area of cross-section of beam	A =	767.0 in <sup>2</sup>
Overall depth of beam	H =	72.0 in
Moment of Inertia	I =	363,218 in <sup>4</sup>
Distance from centroid to extreme <b>bottom</b> fiber	$y_b =$	43.7 in
Distance from centroid to extreme <b>top</b> fiber	$y_t =$	28.3 in
Section modulus for the extreme <b>bottom</b> fiber	$S_b =$	14915.0 in <sup>3</sup>
Section modulus for the extreme <b>top</b> fiber	$S_t =$	15421.0 in <sup>3</sup>
Weight	$W_t =$	799.0 plf
Modulus of Elasticity = $33000 \cdot (W_c \cdot 1.5) \cdot (\sqrt{f'_c})$		
cast-in-place concrete deck	$E_{cs} =$	3834 ksi
precast beam at release	$E_{ci} =$	4496 ksi
precast beam at service loads	$E_c =$	4762 ksi



**COMPOSITE BEAM AT MIDSPAN**

Effective Flange Width	$b_f =$	111.0 in	*min of three criteria
Modular Ratio = $E_{cs}/E_c$	$n =$	0.8052	
Transformed flange width	$=$	89.4 in	
Transformed flange area	$=$	670.3 in <sup>2</sup>	
Transformed haunch width	$=$	33.8 in	
Transformed haunch area	$=$	16.9 in <sup>2</sup>	

	Transformed Area	$y_b$	$Ay_b$	$A(y_{bc}-y_b)^2$	I	$I + A(y_{bc}-y_b)^2$
Beam	767.0 in <sup>2</sup>	43.67 in	33,494.9 in <sup>3</sup>	180,716 in <sup>4</sup>	363,218 in <sup>4</sup>	543,934 in <sup>4</sup>
Haunch	16.9 in <sup>2</sup>	72.25 in	1,221.6 in <sup>3</sup>	2,960 in <sup>4</sup>	0.33 in <sup>4</sup>	2,960 in <sup>4</sup>
Deck	670.3 in <sup>2</sup>	76.25 in	51,110.7 in <sup>3</sup>	199,002 in <sup>4</sup>	2,950 in <sup>4</sup>	201,951 in <sup>4</sup>
Total	1454.2 in <sup>2</sup>		85,827.2 in <sup>3</sup>			748,845 in <sup>4</sup>

Total area of Composite Section	$A_c =$	1454 in <sup>2</sup>
Overall Depth of the Composite Section	$h_c =$	80 in
Moment of Inertia	$I_c =$	748,845 in <sup>4</sup>
Distance from centroid to extreme <u>bottom</u> fiber of beam	$y_{bc} =$	59.02 in
Distance from centroid to extreme <u>top</u> fiber of beam	$y_{tb} =$	12.98 in
Distance from centroid to extreme <u>top</u> fiber of slab	$y_{lc} =$	20.98 in
Section modulus for the extreme <u>bottom</u> fiber of beam	$S_{bc} =$	12,688.0 in <sup>3</sup>
Section modulus for the extreme <u>top</u> fiber of beam	$S_{tb} =$	57,690.9 in <sup>3</sup>
Section modulus for the extreme <u>top</u> fiber slab	$S_{lc} =$	44,329.5 in <sup>3</sup>

**Shear Forces and Bending Moments**

**DEAD LOADS**

Beam self-weight	$w_{beam} =$	0.799 k/f
8 in. deck weight	$w_{deck} =$	1.200 k/f
1/2 in. haunch weight	$w_{haunch} =$	0.022 k/f

**LRFD Specifications: Art. 4.6.2.2.1**

Width of Deck Constant		OK
Number of beams is not less than four $N_b =$	4	OK
Roadway part of the overhang, $d_e \leq 3.0$ ft, $d_e =$	1.5	OK
Curvature in plans is less than $4^\circ =$	0	OK
Cross-section of the bridge is consistent with one of the cross sections given by LRFD specs		OK

Barrier and wearing surface loads are equally distributed among the 4 beams

Barrier Wt	$Wt =$	0.150 k/f
Dead load of future wearing surface	$DW =$	0.263 k/f

**LIVE LOADS**

Fire truck live load front load (Point A)	$P_{live} =$	48.0 kips
Fire truck live load back load (Point B)	$P_{live} =$	22.0 kips
distance between two loads		19.2 ft
distance from nearest edge to point A	$x_a =$	59.0 ft
distance from nearest edge to point B	$x_b =$	39.8 ft

**LRFD Specifications: Art. 4.6.2.2.1**

Width of Deck Constant		OK
Number of beams is not less than four $N_b =$	4	OK
Beams are parallel and approximately of the same stiffness		OK
Roadway part of the overhang, $d_e \leq 3.0$ ft, $d_e =$	1.5	OK
Curvature in plans is less than $4^\circ =$	0	OK

Barrier and wearing surface loads are equally distributed among the 4 beams

Bridge Type-- "k" (LRFD Table 4.6.2.2.1-1)

Number of design lanes = $w/12$	$=$	3 lanes
---------------------------------	-----	---------

**Distribution Factor for Bending Moment:**

Beams spacing	S =	12.0 ft
Depth of concrete slab	t <sub>s</sub> =	7.5 in
Beam Span	L =	120.0 ft
Number of Beams	N <sub>b</sub> =	4
Modular ratio between beam & deck materials	n =	1.2420
Longitudinal stiffness parameter	K <sub>y</sub> =	1,948,702.11 in <sup>4</sup>

at center span:

$$DFM = 0.75 + \left(\frac{S}{9.5}\right)^{0.4} * \left(\frac{S}{L}\right)^{0.3} * \left(\frac{K_y}{12 * L * t_s^3}\right)^{0.1}$$

DFM =	0.891 lanes/beam
-------	------------------

one design lane loaded:

$$DFM = 0.75 + \left(\frac{S}{14}\right)^{0.4} * \left(\frac{S}{L}\right)^{0.3} * \left(\frac{K_y}{12 * L * t_s^3}\right)^{0.1}$$

DFM =	0.604 lanes/beam
-------	------------------

0.905 Controls

**Distribution Factor for Shear Force**

both end spans and center span:

$$DFV = 0.2 + \left(\frac{S'}{12}\right) - \left(\frac{S'}{35}\right)^2$$

DFV =	1.082 lanes/beam
-------	------------------

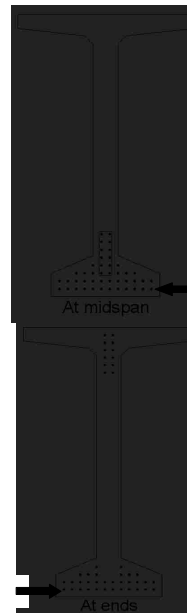
one design lane loaded:

$$DFV = 0.36 + \left(\frac{S'}{25}\right)$$

DFV =	0.840 lanes/beam
-------	------------------

1.082 Controls

from bottom	At Midspan		At Ends	
	No. of	Distance from Bottom	No. of	Distance from Bottom
layer 1	12	2	12	2
layer 2	12	4	12	4
layer 3	8	6	6	6
layer 4	4	8	2	8
layer 5	2	10	-	-
layer 6	2	12	-	-
layer 7	2	14	-	-
layer 8	2	16	-	-
layer 9	-	-	2	60
layer 10	-	-	2	62
layer 11	-	-	2	64
layer 12	-	-	2	66
layer 13	-	-	2	68
layer 14	-	-	2	70
<b>Harped Strand Group (included in above totals)</b>				
layer 3	2	6		
layer 4	2	8		
layer 5	2	10		
layer 6	2	12		
layer 7	2	14		
layer 8	2	16		



distance from the center of gravity of strands to the bottom fiber of the beam = 7% of the beam depth  
strand eccentricity at midspan = (y<sub>c</sub> - y<sub>bs</sub>)

y <sub>bs</sub> =	5.82 in
e <sub>c</sub> =	37.85 in

layer 1



## Prestress Losses

### ELASTIC SHORTENING

assumed loss	=	9.00%
Force per strand at transfer		
layer 1	=	23.4 kips
layer 2	=	26.6 kips
layer 3	=	27.7 kips
layer 4	=	27.7 kips
layer 5	=	27.7 kips
layer 6	=	28.0 kips
layer 7	=	28.0 kips
layer 8	=	28.0 kips
layer 9	=	28.9 kips
layer 10	=	28.9 kips
layer 11	=	28.9 kips
layer 12	=	28.9 kips
layer 13	=	28.9 kips
layer 14	=	28.9 kips

Total prestressing force at release	$P_i =$	at midspan 1155.8 kips	at endspan 1168.4 kips
Sum of concrete stresses at the center of gravity of prestressing tendons due to prestressing force at transfer and the self-weight of the member at sections of maximum moment	$f_{cgp} =$	4.327 ksi	4.393 ksi
Loss due to shortening		at midspan	at endspan
layer 1	$\Delta f_{pES} =$	25.3 ksi	25.6 ksi
layer 2	$\Delta f_{pES} =$	25.8 ksi	26.1 ksi
layer 3	$\Delta f_{pES} =$	26.3 ksi	26.7 ksi
layer 4	$\Delta f_{pES} =$	26.3 ksi	26.7 ksi
layer 5	$\Delta f_{pES} =$	26.0 ksi	
layer 6	$\Delta f_{pES} =$	26.0 ksi	
layer 7	$\Delta f_{pES} =$	25.8 ksi	
layer 8	$\Delta f_{pES} =$	25.8 ksi	
layer 9	$\Delta f_{pES} =$		25.4 ksi
layer 10	$\Delta f_{pES} =$		25.4 ksi
layer 11	$\Delta f_{pES} =$		25.4 ksi
layer 12	$\Delta f_{pES} =$		25.4 ksi
layer 13	$\Delta f_{pES} =$		25.4 ksi
layer 14	$\Delta f_{pES} =$		25.4 ksi

### SHRINKAGE

Shrinkage = $(17 - 0.15 \cdot \text{Relative Humidity})$	$\Delta f_{pSR} =$	6.5 ksi	← assume relative humidity = 70%
--	--------------------	---------	----------------------------------

### CREEP OF CONCRETE

Change of stresses at center of gravity of prestressing due to permanent loads except the loads acting at time of applying prestressing force, calculated at the same section as $f_{cgp}$	$\Delta f_{cgp} =$	2.831 ksi	
loss due to creep	$\Delta f_{pCR} =$	at midspan 32.1 ksi	at endspan 32.9 ksi

**RELAXATION OF PRESTRESSING STRANDS**

loss due to relaxation after transfer		at midspan	at endspan
layer 1	$\Delta f_{pR2} =$	0.7 ksi	0.6 ksi
layer 2	$\Delta f_{pR2} =$	0.6 ksi	0.5 ksi
layer 3	$\Delta f_{pR2} =$	0.5 ksi	0.5 ksi
layer 4	$\Delta f_{pR2} =$	0.5 ksi	0.5 ksi
layer 5	$\Delta f_{pR2} =$	0.6 ksi	
layer 6	$\Delta f_{pR2} =$	0.6 ksi	
layer 7	$\Delta f_{pR2} =$	0.6 ksi	
layer 8	$\Delta f_{pR2} =$	0.6 ksi	
layer 9	$\Delta f_{pR2} =$		0.6 ksi
layer 10	$\Delta f_{pR2} =$		0.6 ksi
layer 11	$\Delta f_{pR2} =$		0.6 ksi
layer 12	$\Delta f_{pR2} =$		0.6 ksi
layer 13	$\Delta f_{pR2} =$		0.6 ksi
layer 14	$\Delta f_{pR2} =$		0.6 ksi

**TOTAL LOSSES AT TRANSFER**

total loss  $\Delta f_{pES} = \Delta f_{pt}$

stress in tendons after transfer  $f_{pt} = f_{pr} - \Delta f_{pt}$

		at midspan	at endspan
layer 1	$f_{pt} =$	142.9 ksi	142.5 ksi
layer 2	$f_{pt} =$	165.2 ksi	164.8 ksi
layer 3	$f_{pt} =$	173.0 ksi	172.6 ksi
layer 4	$f_{pt} =$	173.0 ksi	172.6 ksi
layer 5	$f_{pt} =$	173.3 ksi	
layer 6	$f_{pt} =$	175.4 ksi	
layer 7	$f_{pt} =$	175.6 ksi	
layer 8	$f_{pt} =$	175.6 ksi	
layer 9	$f_{pt} =$		182.2 ksi
layer 10	$f_{pt} =$		182.2 ksi
layer 11	$f_{pt} =$		182.2 ksi
layer 12	$f_{pt} =$		182.2 ksi
layer 13	$f_{pt} =$		182.2 ksi
layer 14	$f_{pt} =$		182.2 ksi

force per strand =  $f_{pt} \cdot \text{strand area}$

		at midspan	at endspan
layer 1	=	21.9 kips	21.8 kips
layer 2	=	25.3 kips	25.2 kips
layer 3	=	26.5 kips	26.4 kips
layer 4	=	26.5 kips	26.4 kips
layer 5	=	26.5 kips	
layer 6	=	26.8 kips	
layer 7	=	26.9 kips	
layer 8	=	26.9 kips	
layer 9	=		27.9 kips
layer 10	=		27.9 kips
layer 11	=		27.9 kips
layer 12	=		27.9 kips
layer 13	=		27.9 kips
layer 14	=		27.9 kips

Total prestressing force after transfer  $P_i =$  1098.6 kips 1110.0 kips

Initial loss =  $(\Delta f_p)/(f_{pi})$

		at midspan	at endspan
layer 1	% =	15.0%	15.2%
layer 2	% =	13.5%	13.7%
layer 3	% =	13.2%	13.4%
layer 4	% =	13.2%	13.4%
layer 5	% =	13.0%	
layer 6	% =	12.9%	
layer 7	% =	12.8%	
layer 8	% =	12.8%	
layer 9	% =		12.2%
layer 10	% =		12.2%
layer 11	% =		12.2%
layer 12	% =		12.2%
layer 13	% =		12.2%
layer 14	% =		12.2%

OK  
OK  
OK  
OK  
OK  
OK  
OK  
OK  
OK  
OK  
OK  
OK  
OK

**TOTAL LOSSES AT SERVICE LOADS**

Total Losses		at midspan	at endspan
layer 1	$\Delta f_{pT} =$	64.5 ksi	64.9 ksi
layer 2	$\Delta f_{pT} =$	65.0 ksi	65.4 ksi
layer 3	$\Delta f_{pT} =$	65.5 ksi	65.9 ksi
layer 4	$\Delta f_{pT} =$	65.5 ksi	65.9 ksi
layer 5	$\Delta f_{pT} =$	65.3 ksi	
layer 6	$\Delta f_{pT} =$	65.3 ksi	
layer 7	$\Delta f_{pT} =$	65.0 ksi	
layer 8	$\Delta f_{pT} =$	65.0 ksi	
layer 9	$\Delta f_{pT} =$		64.6 ksi
layer 10	$\Delta f_{pT} =$		64.6 ksi
layer 11	$\Delta f_{pT} =$		64.6 ksi
layer 12	$\Delta f_{pT} =$		64.6 ksi
layer 13	$\Delta f_{pT} =$		64.6 ksi
layer 14	$\Delta f_{pT} =$		64.6 ksi

Stress in tendon after all losses =  $f_{pi} - \Delta f_{pT}$

		at midspan	at endspan
layer 1	$f_{pe} =$	103.6 ksi	103.3 ksi
layer 2	$f_{pe} =$	126.0 ksi	125.6 ksi
layer 3	$f_{pe} =$	133.8 ksi	133.4 ksi
layer 4	$f_{pe} =$	133.8 ksi	133.4 ksi
layer 5	$f_{pe} =$	134.0 ksi	
layer 6	$f_{pe} =$	136.1 ksi	
layer 7	$f_{pe} =$	136.4 ksi	
layer 8	$f_{pe} =$	136.4 ksi	
layer 9	$f_{pe} =$		143.0 ksi
layer 10	$f_{pe} =$		143.0 ksi
layer 11	$f_{pe} =$		143.0 ksi
layer 12	$f_{pe} =$		143.0 ksi
layer 13	$f_{pe} =$		143.0 ksi
layer 14	$f_{pe} =$		143.0 ksi

check prestressing stress limit at service limit state:  $f_{pe} \leq 0.8 \cdot f_{py}$

layer 1	=	161.7 ksi
layer 2	=	185.7 ksi
layer 3	=	195.7 ksi
layer 4	=	195.7 ksi
layer 5	=	195.7 ksi
layer 6	=	195.7 ksi
layer 7	=	195.7 ksi
layer 8	=	197.7 ksi
layer 9	=	199.7 ksi
layer 10	=	199.7 ksi
layer 11	=	199.7 ksi
layer 12	=	199.7 ksi
layer 13	=	199.7 ksi
layer 14	=	199.7 ksi

OK  
OK  
OK  
OK  
OK  
OK  
OK  
OK  
OK  
OK  
OK  
OK  
OK  
OK

force per strand =  $f_{pe}$  \* strand area

		at midspan	at endspan
layer 1	=	15.9 kips	15.8 kips
layer 2	=	19.3 kips	19.2 kips
layer 3	=	20.5 kips	20.4 kips
layer 4	=	20.5 kips	20.4 kips
layer 5	=	20.5 kips	
layer 6	=	20.8 kips	
layer 7	=	20.9 kips	
layer 8	=	20.9 kips	
layer 9	=		21.9 kips
layer 10	=		21.9 kips
layer 11	=		21.9 kips
layer 12	=		21.9 kips
layer 13	=		21.9 kips
layer 14	=		21.9 kips

Total prestressing force after all losses  $P_{pe}$  =  
 Final losses, % =  $(\Delta f_{pt}) / (f_{pi})$

		at midspan	at endspan
$P_{pe}$ =		833.3 kips	845.9 kips
layer 1	% =	38.4%	38.6%
layer 2	% =	38.7%	38.9%
layer 3	% =	39.0%	39.2%
layer 4	% =	39.0%	39.2%
layer 5	% =	38.8%	
layer 6	% =	38.8%	
layer 7	% =	38.7%	
layer 8	% =	38.7%	
layer 9	% =		38.4%
layer 10	% =		38.4%
layer 11	% =		38.4%
layer 12	% =		38.4%
layer 13	% =		38.4%
layer 14	% =		38.4%
Average final losses, %	% =	38.7%	38.7%

### Stresses at Transfer

#### STRESS LIMITS FOR CONCRETE

Compression = $0.6f_{ci}$	$f_{ci}$ =	3.300 ksi
Tension		
without bonded reinforcement = $-0.0948 \sqrt{f_{ci}} \leq -0.2$	=	-0.200 ksi
with bonded auxiliary reinforcement = $-0.22 \sqrt{f_{ci}}$	=	-0.016 ksi

#### STRESSES AT TRANSFER LENGTH SECTION

Transfer Length = $60 \times$ (strand diameter)	=	2.5 ft	} Calcs for eccentricity (see 9.6.7.2)
Bending moment at transfer length	$M_g$ =	116.4 ft-kips	
center of 12 strands to top fiber of beam at the end	=	7.00 in	
center of 12 strands to bottom fiber of beam at the harp point	=	11.00 in	
center of 12 strands and top fiber of beam at transfer length	=	10.78 in	
center of gravity of 32 strands and bottom fiber of beam	=	3.88 in	
center of gravity of all strands and the bottom fiber of beam at transfer length	=	19.51 in	
center of gravity of all strands and the bottom fiber of beam at the end	=	20.55 in	
Eccentricity of the strand group at transfer length:	$e_n$ =	24.16 in	
Eccentricity at end of beam:	$e$ =	23.12 in	

$$f_t = \frac{P_i}{A} - \frac{P_i e}{S_t} + \frac{M_f}{S_t}$$

$$f_b = \frac{P_i}{A} + \frac{P_i e}{S_b} - \frac{M_f}{S_b}$$

		at midspan	at endspan
Top stress at top fiber of beam	$f_t$ =	-0.198 ksi	-0.201 ksi
Bottom stress at bottom fiber of the beam	$f_b$ =	3.285 ksi	3.285 ksi

OK  
OK

STRESSES AT HARP POINT			
Bending moment due to beam weight at 0.3L	$M_g =$	1188.0 ft-kips	
Top stress at top fiber of beam	$f_t =$	-0.340 ksi	-0.353 ksi
Bottom stress at bottom fiber of the beam	$f_b =$	3.484 ksi	3.308 ksi

OK  
NOT OK

STRESSES AT MIDSPAN			
Bending moment due to beam weight at 0.5L	$M_g =$	1414.3 ft-kips	
Top stress at top fiber of beam	$f_t =$	-0.229 ksi	-0.177 ksi
Bottom stress at bottom fiber of the beam	$f_b =$	3.302 ksi	3.126 ksi

OK  
NOT OK

#### HOLD-DOWN FORCES

assume stress in strand before losses =  $0.8f_u$

layer 1	=	179.4 ksi
layer 2	=	203.7 ksi
layer 3	=	212.6 ksi
layer 4	=	212.6 ksi
layer 5	=	212.6 ksi
layer 6	=	214.8 ksi
layer 7	=	214.8 ksi
layer 8	=	214.8 ksi
layer 9	=	221.4 ksi
layer 10	=	221.4 ksi
layer 11	=	221.4 ksi
layer 12	=	221.4 ksi
layer 13	=	221.4 ksi
layer 14	=	221.4 ksi

prestress force per strand before any losses:

layer 1	=	27.4 kips
layer 2	=	31.2 kips
layer 3	=	32.5 kips
layer 4	=	32.5 kips
layer 5	=	32.5 kips
layer 6	=	32.9 kips
layer 7	=	32.9 kips
layer 8	=	32.9 kips
layer 9	=	33.9 kips
layer 10	=	33.9 kips
layer 11	=	33.9 kips
layer 12	=	33.9 kips
layer 13	=	33.9 kips
layer 14	=	33.9 kips
Harp Angle	$\psi =$	7.2 °

Hold-down force/strand

layer 1	=	3.6 kips/strand
layer 2	=	4.1 kips/strand
layer 3	=	4.3 kips/strand
layer 4	=	4.3 kips/strand
layer 5	=	4.3 kips/strand
layer 6	=	4.3 kips/strand
layer 7	=	4.3 kips/strand
layer 8	=	4.3 kips/strand
layer 9	=	4.4 kips/strand
layer 10	=	4.4 kips/strand
layer 11	=	4.4 kips/strand
layer 12	=	4.4 kips/strand
layer 13	=	4.4 kips/strand
layer 14	=	4.4 kips/strand
Total hold-down force	=	51.52 kips

**Stresses at Service Loads**

**STRESS LIMITS FOR CONCRETE**

**Compression:**

Due to permanent loads for load combination Service I

for the precast beam	=	2.777 ksi
for deck	=	1.800 ksi

Due to permanent and transient loads for load combination Service I

for the precast beam	=	3.702 ksi
for deck	=	2.400 ksi

**Tension:**

Load Combination Service III

for the precast beam	=	-0.015 ksi
----------------------	---	------------

**STRESSES AT MIDSPAN**

Compression stresses at top fiber of beam	at midspan	at endspan	
$f_t = \frac{P_{ps}}{A} - \frac{P_{ps}e}{S_t} + \frac{(M_{ps} + M_{d1})}{S_t} + \frac{(M_{w2} + M_{d2})}{S_{t2}}$			
Due to permanent loads	$f_{t0} =$	1.820 ksi	1.806 ksi
$f_{t2} = \frac{P_{ps}}{A} - \frac{P_{ps}e}{S_t} + \frac{(M_{ps} + M_{d1})}{S_t} + \frac{(M_{w2} + M_{d2})}{S_{t2}} + \frac{(M_{LL1})}{S_{t2}}$			
Due to permanent loads and transient loads	$f_{t2} =$	2.260 ksi	2.246 ksi
Compression stresses at top fiber of deck	at midspan	at endspan	
$f_{t2} = \frac{(M_{w2} + M_{d2})}{S_{t2}}$			
Due to permanent loads	$f_{t0} =$	0.054 ksi	0.054 ksi
$f_{t2} = \frac{(M_{w2} + M_{d2} + M_{LL1})}{S_{t2}}$			
Due to permanent loads and transient loads	$f_{t0} =$	0.627 ksi	0.627 ksi
Tension stresses at top fiber of deck	at midspan	at endspan	
$f_{t2} = \frac{P_{ps}}{A} + \frac{P_{ps}e}{S_b} - \frac{(M_{ps} + M_{d1})}{S_b} - \frac{(M_{w2} + M_{d2} + 0.8 * M_{LL1})}{S_b}$			
Load Combination Service III	$f_{t0} =$	-1.419 ksi	-1.371 ksi

OK

OK

OK

OK

OK

**Strength Limit State**

**POSITIVE MOMENT SECTION**

$M_u = 1.25DC + 1.5DW + 1.75(LL+IM)$	$M_{u0} =$	8381.5 ft-kips
--------------------------------------	------------	----------------

effective length factor for compression members

layer 1	k =	0.28
layer 2	k =	0.26
layer 3	k =	0.24
layer 4	k =	0.24
layer 5	k =	0.24
layer 6	k =	0.26
layer 7	k =	0.26
layer 8	k =	0.24
layer 9	k =	0.28
layer 10	k =	0.28
layer 11	k =	0.28
layer 12	k =	0.28
layer 13	k =	0.28
layer 14	k =	0.28
c =		5.2 ft-kips

average stress in prestressing steel

layer 1	$f_{ps} =$	219.8 ksi
layer 2	$f_{ps} =$	249.7 ksi
layer 3	$f_{ps} =$	260.5 ksi
layer 4	$f_{ps} =$	260.5 ksi
layer 5	$f_{ps} =$	260.5 ksi
layer 6	$f_{ps} =$	263.3 ksi
layer 7	$f_{ps} =$	263.3 ksi
layer 8	$f_{ps} =$	263.3 ksi
layer 9	$f_{ps} =$	271.4 ksi
layer 10	$f_{ps} =$	271.4 ksi
layer 11	$f_{ps} =$	271.4 ksi
layer 12	$f_{ps} =$	271.4 ksi
layer 13	$f_{ps} =$	271.4 ksi
layer 14	$f_{ps} =$	271.4 ksi

nominal flexure resistance

$a =$	4.45 in
$M_r = \Phi M_n, \Phi = 1.00$	$\Phi M_n =$ 9936.1 ft-kips
$M = DC+W+LL+IM$	$M =$ 5833.6 ft-kips

OK  
OK

**NEGATIVE MOMENT SECTION**

$M_u = 1.25DC+1.5DW+1.75(LL+IM)$	$M_u =$ 4837.2 ft-kips
$a =$	6.50 in
$\Phi M_n =$	4853.4 ft-kips
$M = DC+W+LL+IM$	$M =$ 2869.7 ft-kips

OK  
OK

**Shear Design**

**CRITICAL SECTION AT 0.59**

$V_u = 1.25DC+1.5DW+1.75(LL+IM)$	$V_u =$ 405.0 kips
$M_u = 1.25DC+1.5DW+1.75(LL+IM)$	$M_u =$ -2684.4 ft-kips
or	
$V_u = 1.25DC+1.5DW+1.75(LL+IM)$	$V_u =$ 364.8 kips
$M_u = 1.25DC+1.5DW+1.75(LL+IM)$	$M_u =$ -2877.0 ft-kips
max shear	$V_u =$ 405.0 kips
max moment	$M_u =$ 2877.0 ft-kips
Shear depth	$d_v =$ 73.19 in
Applied factored normal force at the section	$N_u =$ 0
Angle of diagonal compressive stresses	$\theta =$ 36.00 °

**STRAIN IN FLEXURAL TENSION REINFORCEMENT**

$$\epsilon_s = \frac{\frac{M_u}{d_v} + 0.5A'_s + 0.5V_u \cot \theta}{E_s A_s + E_s A'_s} \leq 0.002$$

resultant compressive stress at centroid

$f_{dc} =$	at midspan	at endspan
	0.526 ksi	0.528 ksi

effective stress in prestressing strand after all losses

layer 1	$f_{po} =$	106.5 ksi	106.2 ksi
layer 2	$f_{po} =$	128.9 ksi	128.6 ksi
layer 3	$f_{po} =$	136.8 ksi	136.4 ksi
layer 4	$f_{po} =$	136.8 ksi	136.4 ksi
layer 5	$f_{po} =$	137.0 ksi	
layer 6	$f_{po} =$	139.1 ksi	
layer 7	$f_{po} =$	139.3 ksi	
layer 8	$f_{po} =$	139.3 ksi	
layer 9	$f_{po} =$		145.8 ksi
layer 10	$f_{po} =$		145.8 ksi
layer 11	$f_{po} =$		145.8 ksi
layer 12	$f_{po} =$		145.8 ksi
layer 13	$f_{po} =$		145.8 ksi
layer 14	$f_{po} =$		145.8 ksi

strain in flexural tension

		at midspan	at endspan
layer 1	$\epsilon_x =$	0.002000	0.002000
layer 2	$\epsilon_x =$	0.002000	0.002000
layer 3	$\epsilon_x =$	0.002000	0.002000
layer 4	$\epsilon_x =$	0.002000	0.002000
layer 5	$\epsilon_x =$	0.002000	
layer 6	$\epsilon_x =$	0.002000	
layer 7	$\epsilon_x =$	0.002000	
layer 8	$\epsilon_x =$	0.002000	
layer 9	$\epsilon_x =$		0.002000
layer 10	$\epsilon_x =$		0.002000
layer 11	$\epsilon_x =$		0.002000
layer 12	$\epsilon_x =$		0.002000
layer 13	$\epsilon_x =$		0.002000
layer 14	$\epsilon_x =$		0.002000

### Deflection and Camber

Deflection due to Prestressing Force at Transfer  
 Deflection due to Beam Self-Weight at Transfer  
 Deflection due to Beam Self-Weight at Erection  
 Deflection due to Haunch and Deck

	at midspan	at endspan
$\Delta_p =$	3.97 in	3.97 in
$\Delta_g =$	-2.21 in	
$\Delta_{gs} =$	-2.02 in	
$\Delta_s =$	-3.08 in	

Deflection due to total self weight

$\Delta_{sw} =$	-1.13 in
-----------------	----------

Total Deflection at transfer

$\Delta =$	1.76 in	1.76 in
------------	---------	---------

Total Deflection at erection

$\Delta =$	3.42 in	3.42 in
------------	---------	---------

Live load deflection limit = span/800

$=$	-1.80 in
-----	----------

Deflection due to live load and impact

$\Delta_L =$	-1.23 in
--------------	----------

OK

Deflection due to fire truck

$\Delta_L =$	-2.2876 in
--------------	------------

NOT OK

Total Deflection after fire with fire truck

$\Delta =$	0.5529 in
------------	-----------



**Location: Fire at Critical Positive Moment Sections**  
**Beam Design: 1/2" Strand**  
**Fire Exposure Status: 3 Hour**

(PCI Bridge Design Manual Section 9.6)

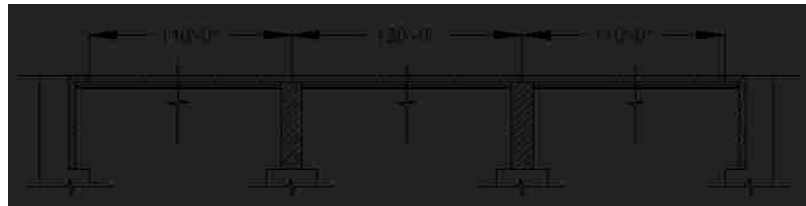


**Material Properties**

CAST-IN-PLACE SLAB			
Actual Thickness	$t_{as} =$		8.0 in
Wearing Surface	$=$		0.5 in
Structural thickness = Actual - Wearing Surface	$t_s =$		7.5 in
Compressive Strength	$f'_c =$		4 ksi
Unit Weight	$w_c =$		150.0 pcf
Stress factor of compression block	$\beta_1 =$		0.85

BEAMS: AASHTO-PCI, BT-72 BULB-TEE			
Strength at release	$f'_{ci} =$		5.5 ksi
Strength at 28 days	$f'_c =$		5.80 ksi
Unit Weight	$w_c =$		150.0 pcf
Overall Beam Length:			
@ end spans	$L =$		110 ft
@ center span	$L =$		119 ft
Design Spans:			
Non-composite beam @ end spans	$L =$		109 ft
Non-composite beam @ center span	$L =$		118 ft
Composite beam @ end spans	$L =$		110 ft
Composite beam @ center span	$L =$		120 ft
Beam Spacing	$S =$		12 ft



**PRESTRESSING STRANDS**

Diameter of single strand	d =	0.5 in
Area of single strand	A =	0.153 in <sup>2</sup>

Temperature of Layer

layer 1 (bottom)	T =	1030.00 °F
layer 2	T =	840.00 °F
layer 3	T =	755.00 °F
layer 4	T =	698.00 °F
layer 5	T =	650.00 °F
layer 6	T =	610.00 °F
layer 7	T =	565.00 °F
layer 8	T =	530.00 °F
layer 9	T =	68.00 °F
layer 10	T =	68.00 °F
layer 11	T =	68.00 °F
layer 12	T =	68.00 °F
layer 13	T =	68.00 °F
layer 14	T =	68.00 °F

Ultimate Strength

initial = 277 ksi

layer 1 (bottom)	f <sub>pu</sub> =	172 ksi
layer 2	f <sub>pu</sub> =	230 ksi
layer 3	f <sub>pu</sub> =	246 ksi
layer 4	f <sub>pu</sub> =	249 ksi
layer 5	f <sub>pu</sub> =	255 ksi
layer 6	f <sub>pu</sub> =	257 ksi
layer 7	f <sub>pu</sub> =	260 ksi
layer 8	f <sub>pu</sub> =	263 ksi
layer 9	f <sub>pu</sub> =	277 ksi
layer 10	f <sub>pu</sub> =	277 ksi
layer 11	f <sub>pu</sub> =	277 ksi
layer 12	f <sub>pu</sub> =	277 ksi
layer 13	f <sub>pu</sub> =	277 ksi
layer 14	f <sub>pu</sub> =	277 ksi

Yield Strength

initial = 250 ksi

layer 1 (bottom)	f <sub>py</sub> =	172 ksi
layer 2	f <sub>py</sub> =	212 ksi
layer 3	f <sub>py</sub> =	222 ksi
layer 4	f <sub>py</sub> =	227 ksi
layer 5	f <sub>py</sub> =	230 ksi
layer 6	f <sub>py</sub> =	235 ksi
layer 7	f <sub>py</sub> =	240 ksi
layer 8	f <sub>py</sub> =	242 ksi
layer 9	f <sub>py</sub> =	250 ksi
layer 10	f <sub>py</sub> =	250 ksi
layer 11	f <sub>py</sub> =	250 ksi
layer 12	f <sub>py</sub> =	250 ksi
layer 13	f <sub>py</sub> =	250 ksi
layer 14	f <sub>py</sub> =	250 ksi

**Stress Limits:**

before transfer ≤ 0.75f<sub>pu</sub> (initial = 202.5)

layer 1 (bottom)	f <sub>pl</sub> =	128.7 ksi
layer 2	f <sub>pl</sub> =	172.3 ksi
layer 3	f <sub>pl</sub> =	184.8 ksi
layer 4	f <sub>pl</sub> =	186.8 ksi
layer 5	f <sub>pl</sub> =	191.0 ksi
layer 6	f <sub>pl</sub> =	193.1 ksi
layer 7	f <sub>pl</sub> =	195.1 ksi
layer 8	f <sub>pl</sub> =	197.2 ksi
layer 9	f <sub>pl</sub> =	207.6 ksi
layer 10	f <sub>pl</sub> =	207.6 ksi
layer 11	f <sub>pl</sub> =	207.6 ksi
layer 12	f <sub>pl</sub> =	207.6 ksi
layer 13	f <sub>pl</sub> =	207.6 ksi
layer 14	f <sub>pl</sub> =	207.6 ksi

at service limit state (after all losses)  $\leq 0.80f_{py}$  (initial = 194.4)

layer 1 (bottom)	$f_{pe} =$	137.8 ksi
layer 2	$f_{pe} =$	169.7 ksi
layer 3	$f_{pe} =$	177.7 ksi
layer 4	$f_{pe} =$	181.7 ksi
layer 5	$f_{pe} =$	183.7 ksi
layer 6	$f_{pe} =$	187.7 ksi
layer 7	$f_{pe} =$	191.7 ksi
layer 8	$f_{pe} =$	193.7 ksi
layer 9	$f_{pe} =$	199.7 ksi
layer 10	$f_{pe} =$	199.7 ksi
layer 11	$f_{pe} =$	199.7 ksi
layer 12	$f_{pe} =$	199.7 ksi
layer 13	$f_{pe} =$	199.7 ksi
layer 14	$f_{pe} =$	199.7 ksi

Modulus of Elasticity

initial = 25982 ksi

layer 1 (bottom)	E =	25982.0 ksi
layer 2	E =	26241.8 ksi
layer 3	E =	26501.6 ksi
layer 4	E =	26501.6 ksi
layer 5	E =	26761.5 ksi
layer 6	E =	27021.3 ksi
layer 7	E =	27021.3 ksi
layer 8	E =	27281.1 ksi
layer 9	E =	25982.0 ksi
layer 10	E =	25982.0 ksi
layer 11	E =	25982.0 ksi
layer 12	E =	25982.0 ksi
layer 13	E =	25982.0 ksi
layer 14	E =	25982.0 ksi

#### REINFORCING BARS

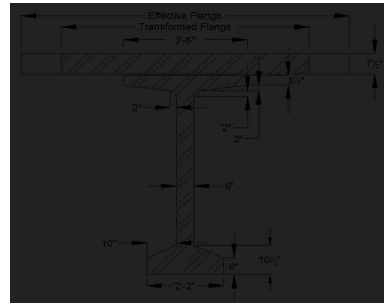
Yield Strength	$f_y =$	57.6 ksi
Modulus of Elasticity	E =	29000.0 ksi

Area of steel at endspan (effective flange)	$A_{se} =$	15.4 in <sup>2</sup>
Area of steel at midspan (effective flange)	$A_{sm} =$	0.0 in <sup>2</sup>
Area of temperature and shrinkage steel (12" width)	$A_s =$	0.0 in <sup>2</sup>

#### Cross-sectional Properties

##### NON-COMPOSITE BEAM

Area of cross-section of beam	A =	767.0 in <sup>2</sup>
Overall depth of beam	H =	72.0 in
Moment of Inertia	I =	322,319 in <sup>4</sup>
Distance from centroid to extreme <b>bottom</b> fiber	$y_b =$	50.7 in
Distance from centroid to extreme <b>top</b> fiber	$y_t =$	21.3 in
Section modulus for the extreme <b>bottom</b> fiber	$S_b =$	14915.0 in <sup>3</sup>
Section modulus for the extreme <b>top</b> fiber	$S_t =$	15421.0 in <sup>3</sup>
Weight	$W_t =$	799.0 plf
Modulus of Elasticity = $33000 \cdot (W_c \cdot 1.5) \cdot (\sqrt{f_c})$		
cast-in-place concrete deck	$E_{cs} =$	3834 ksi
precast beam at release	$E_{ci} =$	4496 ksi
precast beam at service loads	$E_c =$	4617 ksi



**COMPOSITE BEAM AT MIDSPAN**

Effective Flange Width	$b_f =$	111.0 in	*min of three criteria
Modular Ratio = $E_{cs}/E_c$	$n =$	0.8305	
Transformed flange width	$=$	92.2 in	
Transformed flange area	$=$	691.4 in <sup>2</sup>	
Transformed haunch width	$=$	34.9 in	
Transformed haunch area	$=$	17.4 in <sup>2</sup>	

	Transformed Area	$y_b$	$Ay_b$	$A(y_{bc}-y_b)^2$	I	$I + A(y_{bc}-y_b)^2$
Beam	767.0 in <sup>2</sup>	50.74 in	38,917.6 in <sup>3</sup>	114,248 in <sup>4</sup>	322,319 in <sup>4</sup>	436,566 in <sup>4</sup>
Haunch	17.4 in <sup>2</sup>	72.25 in	1,260.0 in <sup>3</sup>	1,510 in <sup>4</sup>	0.33 in <sup>4</sup>	1,510 in <sup>4</sup>
Deck	691.4 in <sup>2</sup>	76.25 in	52,715.7 in <sup>3</sup>	122,392 in <sup>4</sup>	2,950 in <sup>4</sup>	125,341 in <sup>4</sup>
Total	1475.8 in <sup>2</sup>		92,893.3 in <sup>3</sup>			563,418 in <sup>4</sup>

Total area of Composite Section	$A_c =$	1476 in <sup>2</sup>
Overall Depth of the Composite Section	$h_c =$	80 in
Moment of Inertia	$I_c =$	563,418 in <sup>4</sup>
Distance from centroid to extreme <u>bottom</u> fiber of beam	$y_{bc} =$	62.94 in
Distance from centroid to extreme <u>top</u> fiber of beam	$y_{tb} =$	9.06 in
Distance from centroid to extreme <u>top</u> fiber of slab	$y_{lc} =$	17.06 in
Section modulus for the extreme <u>bottom</u> fiber of beam	$S_{bc} =$	8,951.0 in <sup>3</sup>
Section modulus for the extreme <u>top</u> fiber of beam	$S_{tb} =$	62,219.4 in <sup>3</sup>
Section modulus for the extreme <u>top</u> fiber slab	$S_{lc} =$	39,779.1 in <sup>3</sup>

**Shear Forces and Bending Moments**

**DEAD LOADS**

Beam self-weight	$w_{beam} =$	0.799 k/f
8 in. deck weight	$w_{deck} =$	1.200 k/f
1/2 in. haunch weight	$w_{haunch} =$	0.022 k/f

LRFD Specifications: Art. 4.6.2.2.1

Width of Deck Constant		OK
Number of beams is not less than four $N_b =$	4	OK
Roadway part of the overhang, $d_e \leq 3.0$ ft, $d_e =$	1.5	OK
Curvature in plans is less than $4^\circ =$	0	OK
Cross-section of the bridge is consistent with one of the cross sections given by LRFD specs		OK

Barrier and wearing surface loads are equally distributed among the 4 beams

Barrier Wt	$W_t =$	0.150 k/f
Dead load of future wearing surface	$DW =$	0.263 k/f

**LIVE LOADS**

Fire truck live load front load (Point A)	$P_{live} =$	48.0 kips
Fire truck live load back load (Point B)	$P_{live} =$	22.0 kips
distance between two loads		19.2 ft
distance from nearest edge to point A	$x_a =$	59.0 ft
distance from nearest edge to point B	$x_b =$	39.8 ft

LRFD Specifications: Art. 4.6.2.2.1

Width of Deck Constant		OK
Number of beams is not less than four $N_b =$	4	OK
Beams are parallel and approximately of the same stiffness		OK
Roadway part of the overhang, $d_e \leq 3.0$ ft, $d_e =$	1.5	OK
Curvature in plans is less than $4^\circ =$	0	OK

Barrier and wearing surface loads are equally distributed among the 4 beams

Bridge Type-- "k" (LRFD Table 4.6.2.2.1-1)

Number of design lanes = $w/12$	$=$	3 lanes
---------------------------------	-----	---------

**Distribution Factor for Bending Moment:**

Beams spacing	S =	12.0 ft
Depth of concrete slab	t <sub>s</sub> =	7.5 in
Beam Span	L =	120.0 ft
Number of Beams	N <sub>b</sub> =	4
Modular ratio between beam & deck materials	n =	1.2042
Longitudinal stiffness parameter	K <sub>y</sub> =	1,840,120.45 in <sup>4</sup>

at center span:

$$DFM = 0.75 + \left(\frac{S}{9.5}\right)^{0.4} * \left(\frac{S}{L}\right)^{0.3} * \left(\frac{K_y}{12 * L * t_s^3}\right)^{0.1}$$

DFM =	0.886 lanes/beam
-------	------------------

one design lane loaded:

$$DFM = 0.75 + \left(\frac{S}{14}\right)^{0.4} * \left(\frac{S}{L}\right)^{0.3} * \left(\frac{K_y}{12 * L * t_s^3}\right)^{0.1}$$

DFM =	0.601 lanes/beam
-------	------------------

0.905 Controls

**Distribution Factor for Shear Force**

both end spans and center span:

$$DFV = 0.2 + \left(\frac{S'}{12}\right) - \left(\frac{S'}{35}\right)^2$$

DFV =	1.082 lanes/beam
-------	------------------

one design lane loaded:

$$DFV = 0.36 + \left(\frac{S'}{25}\right)$$

DFV =	0.840 lanes/beam
-------	------------------

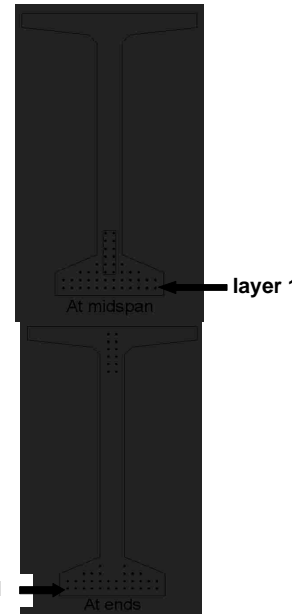
1.082 Controls

from bottom	At Midspan		At Ends	
	No. of	Distance from Bottom	No. of	Distance from Bottom
layer 1	12	2	12	2
layer 2	12	4	12	4
layer 3	8	6	6	6
layer 4	4	8	2	8
layer 5	2	10	-	-
layer 6	2	12	-	-
layer 7	2	14	-	-
layer 8	2	16	-	-
layer 9	-	-	2	60
layer 10	-	-	2	62
layer 11	-	-	2	64
layer 12	-	-	2	66
layer 13	-	-	2	68
layer 14	-	-	2	70
<b>Harpd Strand Group (included in above totals)</b>				
layer 3	2	6		
layer 4	2	8		
layer 5	2	10		
layer 6	2	12		
layer 7	2	14		
layer 8	2	16		

distance from the center of gravity of strands to the bottom fiber of the beam = 7% of the beam depth  
strand eccentricity at midspan = (y<sub>c</sub> - y<sub>bs</sub>)

y <sub>bs</sub> =	5.82 in
e <sub>c</sub> =	44.92 in

layer 1



## Prestress Losses

### ELASTIC SHORTENING

assumed loss	=	9.00%
Force per strand at transfer		
layer 1	=	17.9 kips
layer 2	=	24.0 kips
layer 3	=	25.7 kips
layer 4	=	26.0 kips
layer 5	=	26.6 kips
layer 6	=	26.9 kips
layer 7	=	27.2 kips
layer 8	=	27.5 kips
layer 9	=	28.9 kips
layer 10	=	28.9 kips
layer 11	=	28.9 kips
layer 12	=	28.9 kips
layer 13	=	28.9 kips
layer 14	=	28.9 kips

Total prestressing force at release	$P_i =$	at midspan 1028.8 kips	at endspan 1055.8 kips
Sum of concrete stresses at the center of gravity of prestressing tendons due to prestressing force at transfer and the self-weight of the member at sections of maximum moment	$f_{cgp} =$	5.457 ksi	5.661 ksi
Loss due to shortening		at midspan	at endspan
layer 1	$\Delta f_{pES} =$	31.5 ksi	32.7 ksi
layer 2	$\Delta f_{pES} =$	31.8 ksi	33.0 ksi
layer 3	$\Delta f_{pES} =$	32.2 ksi	33.4 ksi
layer 4	$\Delta f_{pES} =$	32.2 ksi	33.4 ksi
layer 5	$\Delta f_{pES} =$	32.5 ksi	
layer 6	$\Delta f_{pES} =$	32.8 ksi	
layer 7	$\Delta f_{pES} =$	32.8 ksi	
layer 8	$\Delta f_{pES} =$	33.1 ksi	
layer 9	$\Delta f_{pES} =$		32.7 ksi
layer 10	$\Delta f_{pES} =$		32.7 ksi
layer 11	$\Delta f_{pES} =$		32.7 ksi
layer 12	$\Delta f_{pES} =$		32.7 ksi
layer 13	$\Delta f_{pES} =$		32.7 ksi
layer 14	$\Delta f_{pES} =$		32.7 ksi

### SHRINKAGE

Shrinkage = $(17 - 0.15 \cdot \text{Relative Humidity})$	$\Delta f_{pSR} =$	6.5 ksi	← assume relative humidity = 70%
--	--------------------	---------	----------------------------------

### CREEP OF CONCRETE

Change of stresses at center of gravity of prestressing due to permanent loads except the loads acting at time of applying prestressing force, calculated at the same section as $f_{cgp}$	$\Delta f_{cgp} =$	3.802 ksi	
loss due to creep	$\Delta f_{pCR} =$	at midspan 38.9 ksi	at endspan 41.3 ksi

**RELAXATION OF PRESTRESSING STRANDS**

loss due to relaxation after transfer		at midspan	at endspan
layer 1	$\Delta f_{pR2} =$	-0.5 ksi	-0.6 ksi
layer 2	$\Delta f_{pR2} =$	-0.5 ksi	-0.7 ksi
layer 3	$\Delta f_{pR2} =$	-0.6 ksi	-0.7 ksi
layer 4	$\Delta f_{pR2} =$	-0.6 ksi	-0.7 ksi
layer 5	$\Delta f_{pR2} =$	-0.6 ksi	
layer 6	$\Delta f_{pR2} =$	-0.7 ksi	
layer 7	$\Delta f_{pR2} =$	-0.7 ksi	
layer 8	$\Delta f_{pR2} =$	-0.7 ksi	
layer 9	$\Delta f_{pR2} =$		-0.6 ksi
layer 10	$\Delta f_{pR2} =$		-0.6 ksi
layer 11	$\Delta f_{pR2} =$		-0.6 ksi
layer 12	$\Delta f_{pR2} =$		-0.6 ksi
layer 13	$\Delta f_{pR2} =$		-0.6 ksi
layer 14	$\Delta f_{pR2} =$		-0.6 ksi

**TOTAL LOSSES AT TRANSFER**

total loss  $\Delta f_{pES} = \Delta f_{pt}$

stress in tendons after transfer  $f_{pt} = f_{pr} - \Delta f_{pt}$

		at midspan	at endspan
layer 1	$f_{pt} =$	97.2 ksi	96.0 ksi
layer 2	$f_{pt} =$	140.5 ksi	139.3 ksi
layer 3	$f_{pt} =$	152.6 ksi	151.4 ksi
layer 4	$f_{pt} =$	154.7 ksi	153.5 ksi
layer 5	$f_{pt} =$	158.5 ksi	
layer 6	$f_{pt} =$	160.3 ksi	
layer 7	$f_{pt} =$	162.4 ksi	
layer 8	$f_{pt} =$	164.1 ksi	
layer 9	$f_{pt} =$		174.9 ksi
layer 10	$f_{pt} =$		174.9 ksi
layer 11	$f_{pt} =$		174.9 ksi
layer 12	$f_{pt} =$		174.9 ksi
layer 13	$f_{pt} =$		174.9 ksi
layer 14	$f_{pt} =$		174.9 ksi

force per strand =  $f_{pt} \cdot \text{strand area}$

		at midspan	at endspan
layer 1	=	14.9 kips	14.7 kips
layer 2	=	21.5 kips	21.3 kips
layer 3	=	23.3 kips	23.2 kips
layer 4	=	23.7 kips	23.5 kips
layer 5	=	24.3 kips	
layer 6	=	24.5 kips	
layer 7	=	24.8 kips	
layer 8	=	25.1 kips	
layer 9	=		26.8 kips
layer 10	=		26.8 kips
layer 11	=		26.8 kips
layer 12	=		26.8 kips
layer 13	=		26.8 kips
layer 14	=		26.8 kips
Total prestressing force after transfer	$P_i =$	915.4 kips	939.8 kips

Initial loss =  $(\Delta f_p)/(f_{pi})$

		at midspan	at endspan
layer 1	% =	24.5%	25.4%
layer 2	% =	18.5%	19.2%
layer 3	% =	17.4%	18.1%
layer 4	% =	17.2%	17.9%
layer 5	% =	17.0%	
layer 6	% =	17.0%	
layer 7	% =	16.8%	
layer 8	% =	16.8%	
layer 9	% =		15.8%
layer 10	% =		15.8%
layer 11	% =		15.8%
layer 12	% =		15.8%
layer 13	% =		15.8%
layer 14	% =		15.8%

OK  
OK  
OK  
OK  
OK  
OK  
OK  
OK  
OK  
OK  
OK  
OK  
OK  
OK

**TOTAL LOSSES AT SERVICE LOADS**

Total Losses		at midspan	at endspan
layer 1	$\Delta f_{pT} =$	76.4 ksi	77.6 ksi
layer 2	$\Delta f_{pT} =$	76.7 ksi	77.9 ksi
layer 3	$\Delta f_{pT} =$	77.0 ksi	78.2 ksi
layer 4	$\Delta f_{pT} =$	77.0 ksi	78.2 ksi
layer 5	$\Delta f_{pT} =$	77.3 ksi	
layer 6	$\Delta f_{pT} =$	77.7 ksi	
layer 7	$\Delta f_{pT} =$	77.7 ksi	
layer 8	$\Delta f_{pT} =$	78.0 ksi	
layer 9	$\Delta f_{pT} =$		77.6 ksi
layer 10	$\Delta f_{pT} =$		77.6 ksi
layer 11	$\Delta f_{pT} =$		77.6 ksi
layer 12	$\Delta f_{pT} =$		77.6 ksi
layer 13	$\Delta f_{pT} =$		77.6 ksi
layer 14	$\Delta f_{pT} =$		77.6 ksi

Stress in tendon after all losses =  $f_{pi} - \Delta f_{pt}$

		at midspan	at endspan
layer 1	$f_{pe} =$	52.3 ksi	51.1 ksi
layer 2	$f_{pe} =$	95.6 ksi	94.4 ksi
layer 3	$f_{pe} =$	107.7 ksi	106.5 ksi
layer 4	$f_{pe} =$	109.8 ksi	108.6 ksi
layer 5	$f_{pe} =$	113.7 ksi	
layer 6	$f_{pe} =$	115.4 ksi	
layer 7	$f_{pe} =$	117.5 ksi	
layer 8	$f_{pe} =$	119.2 ksi	
layer 9	$f_{pe} =$		130.0 ksi
layer 10	$f_{pe} =$		130.0 ksi
layer 11	$f_{pe} =$		130.0 ksi
layer 12	$f_{pe} =$		130.0 ksi
layer 13	$f_{pe} =$		130.0 ksi
layer 14	$f_{pe} =$		130.0 ksi

check prestressing stress limit at service limit state:  $f_{pe} \leq 0.8 f_{py}$

layer 1	=	137.8 ksi
layer 2	=	169.7 ksi
layer 3	=	177.7 ksi
layer 4	=	181.7 ksi
layer 5	=	183.7 ksi
layer 6	=	187.7 ksi
layer 7	=	191.7 ksi
layer 8	=	193.7 ksi
layer 9	=	199.7 ksi
layer 10	=	199.7 ksi
layer 11	=	199.7 ksi
layer 12	=	199.7 ksi
layer 13	=	199.7 ksi
layer 14	=	199.7 ksi

OK  
OK  
OK  
OK  
OK  
OK  
OK  
OK  
OK  
OK  
OK  
OK  
OK  
OK



force per strand =  $f_{pe}$  \* strand area

		at midspan	at endspan
layer 1	=	8.0 kips	7.8 kips
layer 2	=	14.6 kips	14.4 kips
layer 3	=	16.5 kips	16.3 kips
layer 4	=	16.8 kips	16.6 kips
layer 5	=	17.4 kips	
layer 6	=	17.7 kips	
layer 7	=	18.0 kips	
layer 8	=	18.2 kips	
layer 9	=		19.9 kips
layer 10	=		19.9 kips
layer 11	=		19.9 kips
layer 12	=		19.9 kips
layer 13	=		19.9 kips
layer 14	=		19.9 kips

Total prestressing force after all losses  $P_{pe}$  =  
 Final losses, % =  $(\Delta f_{pt}) / (f_{pi})$

		at midspan	at endspan
$P_{pe}$ =		613.2 kips	637.0 kips
layer 1	% =	59.4%	60.3%
layer 2	% =	59.6%	60.5%
layer 3	% =	59.8%	60.8%
layer 4	% =	59.8%	60.8%
layer 5	% =	60.1%	
layer 6	% =	60.3%	
layer 7	% =	60.3%	
layer 8	% =	60.6%	
layer 9	% =		60.3%
layer 10	% =		60.3%
layer 11	% =		60.3%
layer 12	% =		60.3%
layer 13	% =		60.3%
layer 14	% =		60.3%
Average final losses, %	% =	60.0%	60.4%

### Stresses at Transfer

#### STRESS LIMITS FOR CONCRETE

Compression = $0.6f_{ci}$	$f_{ci}$ =	3.300 ksi
Tension		
without bonded reinforcement = $-0.0948 \sqrt{f_{ci}} \leq -0.2$	=	-0.200 ksi
with bonded auxiliary reinforcement = $-0.22 \sqrt{f_{ci}}$	=	-0.016 ksi

#### STRESSES AT TRANSFER LENGTH SECTION

Transfer Length = $60 \times$ (strand diameter)	=	2.5 ft	} Calcs for eccentricity (see 9.6.7.2)
Bending moment at transfer length	$M_g$ =	116.4 ft-kips	
center of 12 strands to top fiber of beam at the end	=	7.00 in	
center of 12 strands to bottom fiber of beam at the harp point	=	11.00 in	
center of 12 strands and top fiber of beam at transfer length	=	10.78 in	
center of gravity of 32 strands and bottom fiber of beam	=	3.88 in	
center of gravity of all strands and the bottom fiber of beam at transfer length	=	19.51 in	
center of gravity of all strands and the bottom fiber of beam at the end	=	20.55 in	
Eccentricity of the strand group at transfer length:	$e_n$ =	31.23 in	
Eccentricity at end of beam:	$e$ =	30.19 in	

$$f_t = \frac{P_i}{A} - \frac{P_i e}{S_t} + \frac{M_f}{S_t}$$

$$f_b = \frac{P_i}{A} + \frac{P_i e}{S_b} - \frac{M_f}{S_b}$$

		at midspan	at endspan
Top stress at top fiber of beam	$f_t$ =	-0.570 ksi	-0.587 ksi
Bottom stress at bottom fiber of the beam	$f_b$ =	3.402 ksi	3.402 ksi

OK  
NOT OK

STRESSES AT HARP POINT			
Bending moment due to beam weight at 0.3L	$M_g =$	1188.0 ft-kips	
Top stress at top fiber of beam	$f_t =$	-0.549 ksi	-0.588 ksi
Bottom stress at bottom fiber of the beam	$f_b =$	3.484 ksi	3.100 ksi

OK  
NOT OK

STRESSES AT MIDSPAN			
Bending moment due to beam weight at 0.5L	$M_g =$	1414.3 ft-kips	
Top stress at top fiber of beam	$f_t =$	-0.555 ksi	-0.412 ksi
Bottom stress at bottom fiber of the beam	$f_b =$	3.302 ksi	2.918 ksi

OK  
NOT OK

#### HOLD-DOWN FORCES

assume stress in strand before losses =  $0.8f_u$

layer 1	=	137.3 ksi
layer 2	=	183.8 ksi
layer 3	=	197.1 ksi
layer 4	=	199.3 ksi
layer 5	=	203.7 ksi
layer 6	=	205.9 ksi
layer 7	=	208.2 ksi
layer 8	=	210.4 ksi
layer 9	=	221.4 ksi
layer 10	=	221.4 ksi
layer 11	=	221.4 ksi
layer 12	=	221.4 ksi
layer 13	=	221.4 ksi
layer 14	=	221.4 ksi

prestress force per strand before any losses:

layer 1	=	21.0 kips
layer 2	=	28.1 kips
layer 3	=	30.2 kips
layer 4	=	30.5 kips
layer 5	=	31.2 kips
layer 6	=	31.5 kips
layer 7	=	31.8 kips
layer 8	=	32.2 kips
layer 9	=	33.9 kips
layer 10	=	33.9 kips
layer 11	=	33.9 kips
layer 12	=	33.9 kips
layer 13	=	33.9 kips
layer 14	=	33.9 kips
Harp Angle	$\psi =$	7.2 °

Hold-down force/strand

layer 1	=	2.8 kips/strand
layer 2	=	3.7 kips/strand
layer 3	=	4.0 kips/strand
layer 4	=	4.0 kips/strand
layer 5	=	4.1 kips/strand
layer 6	=	4.1 kips/strand
layer 7	=	4.2 kips/strand
layer 8	=	4.2 kips/strand
layer 9	=	4.4 kips/strand
layer 10	=	4.4 kips/strand
layer 11	=	4.4 kips/strand
layer 12	=	4.4 kips/strand
layer 13	=	4.4 kips/strand
layer 14	=	4.4 kips/strand
Total hold-down force	=	49.21 kips

### Stresses at Service Loads

#### STRESS LIMITS FOR CONCRETE

##### Compression:

Due to permanent loads for load combination Service I

for the precast beam	=	2.610 ksi
for deck	=	1.800 ksi

Due to permanent and transient loads for load combination Service I

for the precast beam	=	3.480 ksi
for deck	=	2.400 ksi

##### Tension:

Load Combination Service III

for the precast beam	=	-0.014 ksi
----------------------	---	------------

#### STRESSES AT MIDSPAN

Compression stresses at top fiber of beam	at midspan	at endspan		
$f_t = \frac{P_{ps}}{A} - \frac{P_{ps}e}{S_t} + \frac{(M_p + M_s)}{S_t} + \frac{(M_w + M_d)}{S_{ty}}$				
Due to permanent loads	$f_{t0} =$	1.789 ksi	1.751 ksi	OK
$f_{ty} = \frac{P_{ps}}{A} - \frac{P_{ps}e}{S_t} + \frac{(M_p + M_s)}{S_t} + \frac{(M_w + M_d)}{S_{ty}} + \frac{(M_{LL1})}{S_{ty}}$				
Due to permanent loads and transient loads	$f_{ty} =$	2.197 ksi	2.159 ksi	OK
Compression stresses at top fiber of deck	at midspan	at endspan		
$f_{ts} = \frac{(M_w + M_d)}{S_{tr}}$				
Due to permanent loads	$f_{t0} =$	0.061 ksi	0.061 ksi	OK
$f_{ty} = \frac{(M_w + M_d + M_{LL1})}{S_{tr}}$				
Due to permanent loads and transient loads	$f_{ty} =$	0.699 ksi	0.699 ksi	OK
Tension stresses at top fiber of deck	at midspan	at endspan		
$f_{ty} = \frac{P_{ps}}{A} + \frac{P_{ps}e}{S_b} - \frac{(M_p + M_s)}{S_b} - \frac{(M_w + M_d + 0.8 * M_{LL1})}{S_b}$				
Load Combination Service III	$f_{t0} =$	-2.722 ksi	-2.619 ksi	OK

### Strength Limit State

#### POSITIVE MOMENT SECTION

$M_u = 1.25DC + 1.5DW + 1.75(LL+IM)$	$M_{u0} =$	8381.5 ft-kips
--------------------------------------	------------	----------------

effective length factor for compression members

layer 1	k =	0.07
layer 2	k =	0.23
layer 3	k =	0.28
layer 4	k =	0.26
layer 5	k =	0.28
layer 6	k =	0.26
layer 7	k =	0.24
layer 8	k =	0.24
layer 9	k =	0.28
layer 10	k =	0.28
layer 11	k =	0.28
layer 12	k =	0.28
layer 13	k =	0.28
layer 14	k =	0.28
c =		4.7 ft-kips

average stress in prestressing steel

layer 1	$f_{ps} =$	170.8 ksi
layer 2	$f_{ps} =$	228.7 ksi
layer 3	$f_{ps} =$	245.2 ksi
layer 4	$f_{ps} =$	248.0 ksi
layer 5	$f_{ps} =$	253.5 ksi
layer 6	$f_{ps} =$	256.2 ksi
layer 7	$f_{ps} =$	259.0 ksi
layer 8	$f_{ps} =$	261.7 ksi
layer 9	$f_{ps} =$	275.5 ksi
layer 10	$f_{ps} =$	275.5 ksi
layer 11	$f_{ps} =$	275.5 ksi
layer 12	$f_{ps} =$	275.5 ksi
layer 13	$f_{ps} =$	275.5 ksi
layer 14	$f_{ps} =$	275.5 ksi

nominal flexure resistance

$a =$	3.98 in
$M_r = \Phi M_n, \Phi = 1.00$	$\Phi M_n =$ 8970.1 ft-kips
$M = DC+W+LL+IM$	$M =$ 5833.6 ft-kips

OK  
OK

**NEGATIVE MOMENT SECTION**

$M_u = 1.25DC+1.5DW+1.75(LL+IM)$	$M_u =$ 4837.2 ft-kips
$a =$	6.92 in
$\Phi M_n =$	4839.6 ft-kips
$M = DC+W+LL+IM$	$M =$ 2869.7 ft-kips

OK  
OK

**Shear Design**

**CRITICAL SECTION AT 0.59**

$V_u = 1.25DC+1.5DW+1.75(LL+IM)$	$V_u =$ 405.0 kips
$M_u = 1.25DC+1.5DW+1.75(LL+IM)$	$M_u =$ -2684.4 ft-kips
or	
$V_u = 1.25DC+1.5DW+1.75(LL+IM)$	$V_u =$ 364.8 kips
$M_u = 1.25DC+1.5DW+1.75(LL+IM)$	$M_u =$ -2877.0 ft-kips
max shear	$V_u =$ 405.0 kips
max moment	$M_u =$ 2877.0 ft-kips
Shear depth	$d_v =$ 73.19 in
Applied factored normal force at the section	$N_u =$ 0
Angle of diagonal compressive stresses	$\theta =$ 36.00 °

**STRAIN IN FLEXURAL TENSION REINFORCEMENT**

$$\epsilon_s = \frac{\frac{M_u}{d_v} + 0.5A'_s + 0.5V_u \cot \theta}{E_s A_s + E_s A'_s} \leq 0.002$$

resultant compressive stress at centroid

$f_{dc} =$	at midspan	at endspan
	0.348 ksi	0.350 ksi

effective stress in prestressing strand after all losses

layer 1	$f_{po} =$	54.3 ksi	53.1 ksi
layer 2	$f_{po} =$	97.6 ksi	96.4 ksi
layer 3	$f_{po} =$	109.7 ksi	108.5 ksi
layer 4	$f_{po} =$	111.8 ksi	110.6 ksi
layer 5	$f_{po} =$	115.7 ksi	
layer 6	$f_{po} =$	117.5 ksi	
layer 7	$f_{po} =$	119.5 ksi	
layer 8	$f_{po} =$	121.3 ksi	
layer 9	$f_{po} =$		132.0 ksi
layer 10	$f_{po} =$		132.0 ksi
layer 11	$f_{po} =$		132.0 ksi
layer 12	$f_{po} =$		132.0 ksi
layer 13	$f_{po} =$		132.0 ksi
layer 14	$f_{po} =$		132.0 ksi

strain in flexural tension

		at midspan	at endspan
layer 1	$\epsilon_x =$	0.002000	0.002000
layer 2	$\epsilon_x =$	0.002000	0.002000
layer 3	$\epsilon_x =$	0.002000	0.002000
layer 4	$\epsilon_x =$	0.002000	0.002000
layer 5	$\epsilon_x =$	0.002000	
layer 6	$\epsilon_x =$	0.002000	
layer 7	$\epsilon_x =$	0.002000	
layer 8	$\epsilon_x =$	0.002000	
layer 9	$\epsilon_x =$		0.002000
layer 10	$\epsilon_x =$		0.002000
layer 11	$\epsilon_x =$		0.002000
layer 12	$\epsilon_x =$		0.002000
layer 13	$\epsilon_x =$		0.002000
layer 14	$\epsilon_x =$		0.002000

### Deflection and Camber

		at midspan	at endspan
Deflection due to Prestressing Force at Transfer	$\Delta_p =$	3.97 in	3.97 in
Deflection due to Beam Self-Weight at Transfer	$\Delta_g =$	-2.49 in	
Deflection due to Beam Self-Weight at Erection	$\Delta_{g1} =$	-2.34 in	
Deflection due to Haunch and Deck	$\Delta_s =$	-3.58 in	
Deflection due to total self weight	$\Delta_{sw} =$	-1.96 in	
Total Deflection at transfer	$\Delta =$	1.48 in	1.48 in
Total Deflection at erection	$\Delta =$	2.81 in	2.81 in
Live load deflection limit = span/800	$=$	-1.80 in	
Deflection due to live load and impact	$\Delta_L =$	-1.69 in	
Deflection due to fire truck	$\Delta_L =$	-2.6588 in	
Total Deflection after fire with fire truck	$\Delta =$	-0.6454 in	

OK

NOT OK

**Location: Fire at Critical Positive Moment Sections**  
**Beam Design: 1/2" Strand**  
**Fire Exposure Status: 4 Hour**

(PCI Bridge Design Manual Section 9.6)

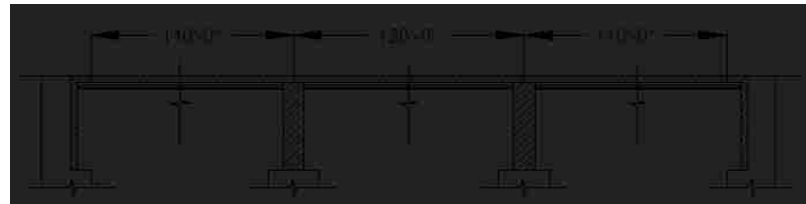


**Material Properties**

CAST-IN-PLACE SLAB		
Actual Thickness	$t_{as} =$	8.0 in
Wearing Surface	$=$	0.5 in
Structural thickness = Actual - Wearing Surface	$t_s =$	7.5 in
Compressive Strength	$f'_c =$	4 ksi
Unit Weight	$w_c =$	150.0 pcf
Stress factor of compression block	$\beta_1 =$	0.85

BEAMS: AASHTO-PCI, BT-72 BULB-TEE		
Strength at release	$f_{ci} =$	5.5 ksi
Strength at 28 days	$f'_c =$	5.46 ksi
Unit Weight	$w_c =$	150.0 pcf
Overall Beam Length:		
@ end spans	$L =$	110 ft
@ center span	$L =$	119 ft
Design Spans:		
Non-composite beam @ end spans	$L =$	109 ft
Non-composite beam @ center span	$L =$	118 ft
Composite beam @ end spans	$L =$	110 ft
Composite beam @ center span	$L =$	120 ft
Beam Spacing	$S =$	12 ft



**PRESTRESSING STRANDS**

Diameter of single strand	d =	0.5 in
Area of single strand	A =	0.153 in <sup>2</sup>

Temperature of Layer

layer 1 (bottom)	T =	1100.00 °F
layer 2	T =	940.00 °F
layer 3	T =	860.00 °F
layer 4	T =	800.00 °F
layer 5	T =	770.00 °F
layer 6	T =	735.00 °F
layer 7	T =	700.00 °F
layer 8	T =	675.00 °F
layer 9	T =	68.00 °F
layer 10	T =	68.00 °F
layer 11	T =	68.00 °F
layer 12	T =	68.00 °F
layer 13	T =	68.00 °F
layer 14	T =	68.00 °F

Ultimate Strength

initial = 277 ksi

layer 1 (bottom)	f <sub>pu</sub> =	147 ksi
layer 2	f <sub>pu</sub> =	205 ksi
layer 3	f <sub>pu</sub> =	227 ksi
layer 4	f <sub>pu</sub> =	244 ksi
layer 5	f <sub>pu</sub> =	246 ksi
layer 6	f <sub>pu</sub> =	246 ksi
layer 7	f <sub>pu</sub> =	249 ksi
layer 8	f <sub>pu</sub> =	252 ksi
layer 9	f <sub>pu</sub> =	277 ksi
layer 10	f <sub>pu</sub> =	277 ksi
layer 11	f <sub>pu</sub> =	277 ksi
layer 12	f <sub>pu</sub> =	277 ksi
layer 13	f <sub>pu</sub> =	277 ksi
layer 14	f <sub>pu</sub> =	277 ksi

Yield Strength

initial = 250 ksi

layer 1 (bottom)	f <sub>py</sub> =	150 ksi
layer 2	f <sub>py</sub> =	197 ksi
layer 3	f <sub>py</sub> =	205 ksi
layer 4	f <sub>py</sub> =	217 ksi
layer 5	f <sub>py</sub> =	220 ksi
layer 6	f <sub>py</sub> =	225 ksi
layer 7	f <sub>py</sub> =	227 ksi
layer 8	f <sub>py</sub> =	230 ksi
layer 9	f <sub>py</sub> =	250 ksi
layer 10	f <sub>py</sub> =	250 ksi
layer 11	f <sub>py</sub> =	250 ksi
layer 12	f <sub>py</sub> =	250 ksi
layer 13	f <sub>py</sub> =	250 ksi
layer 14	f <sub>py</sub> =	250 ksi

**Stress Limits:**

before transfer ≤ 0.75f<sub>pu</sub> (initial = 202.5)

layer 1 (bottom)	f <sub>di</sub> =	110.0 ksi
layer 2	f <sub>di</sub> =	153.6 ksi
layer 3	f <sub>di</sub> =	170.2 ksi
layer 4	f <sub>di</sub> =	182.7 ksi
layer 5	f <sub>di</sub> =	184.8 ksi
layer 6	f <sub>di</sub> =	184.8 ksi
layer 7	f <sub>di</sub> =	186.8 ksi
layer 8	f <sub>di</sub> =	188.9 ksi
layer 9	f <sub>di</sub> =	207.6 ksi
layer 10	f <sub>di</sub> =	207.6 ksi
layer 11	f <sub>di</sub> =	207.6 ksi
layer 12	f <sub>di</sub> =	207.6 ksi
layer 13	f <sub>di</sub> =	207.6 ksi
layer 14	f <sub>di</sub> =	207.6 ksi

at service limit state (after all losses)  $\leq 0.80f_{py}$  (initial = 194.4)

layer 1 (bottom)	$f_{pe} =$	119.8 ksi
layer 2	$f_{pe} =$	157.7 ksi
layer 3	$f_{pe} =$	163.7 ksi
layer 4	$f_{pe} =$	173.7 ksi
layer 5	$f_{pe} =$	175.7 ksi
layer 6	$f_{pe} =$	179.7 ksi
layer 7	$f_{pe} =$	181.7 ksi
layer 8	$f_{pe} =$	183.7 ksi
layer 9	$f_{pe} =$	199.7 ksi
layer 10	$f_{pe} =$	199.7 ksi
layer 11	$f_{pe} =$	199.7 ksi
layer 12	$f_{pe} =$	199.7 ksi
layer 13	$f_{pe} =$	199.7 ksi
layer 14	$f_{pe} =$	199.7 ksi

Modulus of Elasticity

initial = 25982 ksi

layer 1 (bottom)	E =	25722.2 ksi
layer 2	E =	26241.8 ksi
layer 3	E =	26241.8 ksi
layer 4	E =	26241.8 ksi
layer 5	E =	26241.8 ksi
layer 6	E =	26501.6 ksi
layer 7	E =	26501.6 ksi
layer 8	E =	26761.5 ksi
layer 9	E =	25982.0 ksi
layer 10	E =	25982.0 ksi
layer 11	E =	25982.0 ksi
layer 12	E =	25982.0 ksi
layer 13	E =	25982.0 ksi
layer 14	E =	25982.0 ksi

#### REINFORCING BARS

Yield Strength	$f_y =$	57.6 ksi
Modulus of Elasticity	E =	29000.0 ksi

Area of steel at endspan (effective flange)  $A_{se} =$  15.4 in<sup>2</sup>

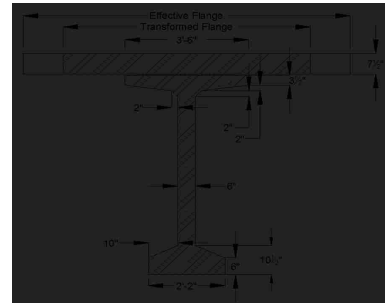
Area of steel at midspan (effective flange)  $A_{sm} =$  0.0 in<sup>2</sup>

Area of temperature and shrinkage steel (12" width)  $A_s =$  0.0 in<sup>2</sup>

#### Cross-sectional Properties

##### NON-COMPOSITE BEAM

Area of cross-section of beam	A =	767.0 in <sup>2</sup>
Overall depth of beam	H =	72.0 in
Moment of Inertia	I =	211,427 in <sup>4</sup>
Distance from centroid to extreme <b>bottom</b> fiber	$y_b =$	51.1 in
Distance from centroid to extreme <b>top</b> fiber	$y_t =$	20.9 in
Section modulus for the extreme <b>bottom</b> fiber	$S_b =$	14915.0 in <sup>3</sup>
Section modulus for the extreme <b>top</b> fiber	$S_t =$	15421.0 in <sup>3</sup>
Weight	$W_f =$	799.0 plf
Modulus of Elasticity = $33000 \cdot (W_c \cdot 1.5) \cdot (\sqrt{f_c})$		
cast-in-place concrete deck	$E_{cs} =$	3834 ksi
precast beam at release	$E_{ci} =$	4496 ksi
precast beam at service loads	$E_c =$	4480 ksi





**COMPOSITE BEAM AT MIDSPAN**

Effective Flange Width	$b_f =$	111.0 in	*min of three criteria
Modular Ratio = $E_{cs}/E_c$	$n =$	0.8559	
Transformed flange width	$=$	95.0 in	
Transformed flange area	$=$	712.6 in <sup>2</sup>	
Transformed haunch width	$=$	35.9 in	
Transformed haunch area	$=$	18.0 in <sup>2</sup>	

	Transformed Area	$y_b$	$Ay_b$	$A(y_{bc}-y_b)^2$	I	$I + A(y_{bc}-y_b)^2$
Beam	767.0 in <sup>2</sup>	51.13 in	39,216.7 in <sup>3</sup>	114,274 in <sup>4</sup>	211,427 in <sup>4</sup>	325,701 in <sup>4</sup>
Haunch	18.0 in <sup>2</sup>	72.25 in	1,298.6 in <sup>3</sup>	1,428 in <sup>4</sup>	0.33 in <sup>4</sup>	1,429 in <sup>4</sup>
Deck	712.6 in <sup>2</sup>	76.25 in	54,332.3 in <sup>3</sup>	118,832 in <sup>4</sup>	2,950 in <sup>4</sup>	121,781 in <sup>4</sup>
Total	1497.5 in <sup>2</sup>		94,847.6 in <sup>3</sup>			448,911 in <sup>4</sup>

Total area of Composite Section	$A_c =$	1498 in <sup>2</sup>
Overall Depth of the Composite Section	$h_c =$	80 in
Moment of Inertia	$I_c =$	448,911 in <sup>4</sup>
Distance from centroid to extreme <u>bottom</u> fiber of beam	$y_{bc} =$	63.34 in
Distance from centroid to extreme <u>top</u> fiber of beam	$y_{tg} =$	8.66 in
Distance from centroid to extreme <u>top</u> fiber of slab	$y_{tc} =$	16.66 in
Section modulus for the extreme <u>bottom</u> fiber of beam	$S_{bc} =$	7,087.8 in <sup>3</sup>
Section modulus for the extreme <u>top</u> fiber of beam	$S_{tg} =$	51,814.0 in <sup>3</sup>
Section modulus for the extreme <u>top</u> fiber slab	$S_{tc} =$	31,473.9 in <sup>3</sup>

**Shear Forces and Bending Moments**

**DEAD LOADS**

Beam self-weight	$W_{beam} =$	0.799 k/f
8 in. deck weight	$W_{deck} =$	1.200 k/f
1/2 in. haunch weight	$W_{haunch} =$	0.022 k/f

LRFD Specifications: Art. 4.6.2.2.1

Width of Deck Constant		OK
Number of beams is not less than four $N_b =$	4	OK
Roadway part of the overhang, $d_o \leq 3.0$ ft, $d_o =$	1.5	OK
Curvature in plans is less than $4^\circ =$	0	OK
Cross-section of the bridge is consistent with one of the cross sections given by LRFD specs		OK

Barrier and wearing surface loads are equally distributed among the 4 beams

Barrier Wt	$W_t =$	0.150 k/f
Dead load of future wearing surface	$DW =$	0.263 k/f

**LIVE LOADS**

Fire truck live load front load (Point A)	$P_{live} =$	48.0 kips
Fire truck live load back load (Point B)	$P_{live} =$	22.0 kips
distance between two loads		19.2 ft
distance from nearest edge to point A	$x_a =$	59.0 ft
distance from nearest edge to point B	$x_b =$	39.8 ft

LRFD Specifications: Art. 4.6.2.2.1

Width of Deck Constant		OK
Number of beams is not less than four $N_b =$	4	OK
Beams are parallel and approximately of the same stiffness		OK
Roadway part of the overhang, $d_o \leq 3.0$ ft, $d_o =$	1.5	OK
Curvature in plans is less than $4^\circ =$	0	OK

Barrier and wearing surface loads are equally distributed among the 4 beams

Bridge Type-- "k" (LRFD Table 4.6.2.2.1-1)

Number of design lanes = $w/12$	$=$	3 lanes
---------------------------------	-----	---------

**Distribution Factor for Bending Moment:**

Beams spacing	S =	12.0 ft
Depth of concrete slab	t <sub>s</sub> =	7.5 in
Beam Span	L =	120.0 ft
Number of Beams	N <sub>b</sub> =	4
Modular ratio between beam & deck materials	n =	1.1683
Longitudinal stiffness parameter	K <sub>g</sub> =	1,655,812.84 in <sup>4</sup>

at center span:

$$DFM = 0.75 + \left(\frac{S}{9.5}\right)^{1.6} * \left(\frac{S}{L}\right)^{0.1} * \left(\frac{K_g}{12 * L * t_s^3}\right)^{0.1}$$

DFM =	0.877 lanes/beam
-------	------------------

one design lane loaded:

$$DFM = 0.75 + \left(\frac{S}{14}\right)^{1.6} * \left(\frac{S}{L}\right)^{0.1} * \left(\frac{K_g}{12 * L * t_s^3}\right)^{0.1}$$

DFM =	0.596 lanes/beam
-------	------------------

0.905 Controls

**Distribution Factor for Shear Force**

both end spans and center span:

$$DFV = 0.2 + \left(\frac{S}{12}\right) - \left(\frac{S}{35}\right)^2$$

DFV =	1.082 lanes/beam
-------	------------------

one design lane loaded:

$$DFV = 0.36 + \left(\frac{S}{25}\right)$$

DFV =	0.840 lanes/beam
-------	------------------

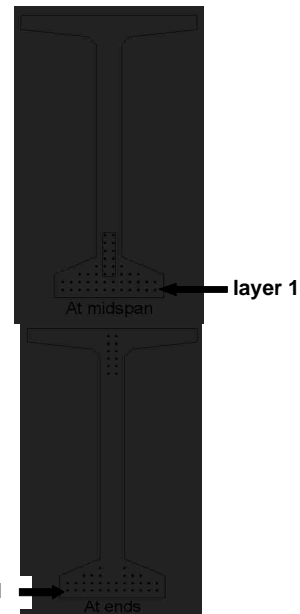
1.082 Controls

from bottom	At Midspan		At Ends	
	No. of	Distance from Bottom	No. of	Distance from Bottom
layer 1	12	2	12	2
layer 2	12	4	12	4
layer 3	8	6	6	6
layer 4	4	8	2	8
layer 5	2	10	-	-
layer 6	2	12	-	-
layer 7	2	14	-	-
layer 8	2	16	-	-
layer 9	-	-	2	60
layer 10	-	-	2	62
layer 11	-	-	2	64
layer 12	-	-	2	66
layer 13	-	-	2	68
layer 14	-	-	2	70
<b>Harped Strand Group (included in above totals)</b>				
layer 3	2	6		
layer 4	2	8		
layer 5	2	10		
layer 6	2	12		
layer 7	2	14		
layer 8	2	16		

distance from the center of gravity of strands to the bottom fiber of the beam = 7% of the beam depth  
strand eccentricity at midspan = (y<sub>c</sub> - y<sub>bs</sub>)

y <sub>bs</sub> =	5.82 in
e <sub>c</sub> =	45.31 in

layer 1



## Prestress Losses

### ELASTIC SHORTENING

assumed loss	=	9.00%
Force per strand at transfer		
layer 1	=	15.3 kips
layer 2	=	21.4 kips
layer 3	=	23.7 kips
layer 4	=	25.4 kips
layer 5	=	25.7 kips
layer 6	=	25.7 kips
layer 7	=	26.0 kips
layer 8	=	26.3 kips
layer 9	=	28.9 kips
layer 10	=	28.9 kips
layer 11	=	28.9 kips
layer 12	=	28.9 kips
layer 13	=	28.9 kips
layer 14	=	28.9 kips

Total prestressing force at release	$P_i =$	at midspan 939.0 kips	at endspan 980.2 kips
Sum of concrete stresses at the center of gravity of prestressing tendons due to prestressing force at transfer and the self-weight of the member at sections of maximum moment	$f_{cgp} =$	6.766 ksi	7.220 ksi
Loss due to shortening		at midspan	at endspan
layer 1	$\Delta f_{pES} =$	38.7 ksi	41.3 ksi
layer 2	$\Delta f_{pES} =$	39.5 ksi	42.1 ksi
layer 3	$\Delta f_{pES} =$	39.5 ksi	42.1 ksi
layer 4	$\Delta f_{pES} =$	39.5 ksi	42.1 ksi
layer 5	$\Delta f_{pES} =$	39.5 ksi	
layer 6	$\Delta f_{pES} =$	39.9 ksi	
layer 7	$\Delta f_{pES} =$	39.9 ksi	
layer 8	$\Delta f_{pES} =$	40.3 ksi	
layer 9	$\Delta f_{pES} =$		41.7 ksi
layer 10	$\Delta f_{pES} =$		41.7 ksi
layer 11	$\Delta f_{pES} =$		41.7 ksi
layer 12	$\Delta f_{pES} =$		41.7 ksi
layer 13	$\Delta f_{pES} =$		41.7 ksi
layer 14	$\Delta f_{pES} =$		41.7 ksi

### SHRINKAGE

Shrinkage = $(17 - 0.15 \cdot \text{Relative Humidity})$	$\Delta f_{BSR} =$	6.5 ksi	← assume relative humidity = 70%
--	--------------------	---------	----------------------------------

### CREEP OF CONCRETE

Change of stresses at center of gravity of prestressing due to permanent loads except the loads acting at time of applying prestressing force, calculated at the same section as $f_{cgp}$	$\Delta f_{cgp} =$	5.779 ksi	
loss due to creep	$\Delta f_{PCR} =$	at midspan 40.7 ksi	at endspan 46.2 ksi

**RELAXATION OF PRESTRESSING STRANDS**

loss due to relaxation after transfer		at midspan	at endspan
layer 1	$\Delta f_{PR2} =$	-1.5 ksi	-1.8 ksi
layer 2	$\Delta f_{PR2} =$	-1.6 ksi	-1.9 ksi
layer 3	$\Delta f_{PR2} =$	-1.6 ksi	-1.9 ksi
layer 4	$\Delta f_{PR2} =$	-1.6 ksi	-1.9 ksi
layer 5	$\Delta f_{PR2} =$	-1.6 ksi	
layer 6	$\Delta f_{PR2} =$	-1.6 ksi	
layer 7	$\Delta f_{PR2} =$	-1.6 ksi	
layer 8	$\Delta f_{PR2} =$	-1.7 ksi	
layer 9	$\Delta f_{PR2} =$		-1.8 ksi
layer 10	$\Delta f_{PR2} =$		-1.8 ksi
layer 11	$\Delta f_{PR2} =$		-1.8 ksi
layer 12	$\Delta f_{PR2} =$		-1.8 ksi
layer 13	$\Delta f_{PR2} =$		-1.8 ksi
layer 14	$\Delta f_{PR2} =$		-1.8 ksi

**TOTAL LOSSES AT TRANSFER**

total loss  $\Delta f_{pES} = \Delta f_{pt}$

stress in tendons after transfer  $f_{pt} = f_{pr} - \Delta f_{pt}$

		at midspan	at endspan
layer 1	$f_{pt} =$	71.3 ksi	68.7 ksi
layer 2	$f_{pt} =$	114.1 ksi	111.5 ksi
layer 3	$f_{pt} =$	130.7 ksi	128.1 ksi
layer 4	$f_{pt} =$	143.2 ksi	140.5 ksi
layer 5	$f_{pt} =$	145.3 ksi	
layer 6	$f_{pt} =$	144.9 ksi	
layer 7	$f_{pt} =$	147.0 ksi	
layer 8	$f_{pt} =$	148.6 ksi	
layer 9	$f_{pt} =$		165.9 ksi
layer 10	$f_{pt} =$		165.9 ksi
layer 11	$f_{pt} =$		165.9 ksi
layer 12	$f_{pt} =$		165.9 ksi
layer 13	$f_{pt} =$		165.9 ksi
layer 14	$f_{pt} =$		165.9 ksi

force per strand =  $f_{pt} \cdot \text{strand area}$

		at midspan	at endspan
layer 1	=	10.9 kips	10.5 kips
layer 2	=	17.5 kips	17.1 kips
layer 3	=	20.0 kips	19.6 kips
layer 4	=	21.9 kips	21.5 kips
layer 5	=	22.2 kips	
layer 6	=	22.2 kips	
layer 7	=	22.5 kips	
layer 8	=	22.7 kips	
layer 9	=		25.4 kips
layer 10	=		25.4 kips
layer 11	=		25.4 kips
layer 12	=		25.4 kips
layer 13	=		25.4 kips
layer 14	=		25.4 kips

Total prestressing force after transfer  $P_i =$  767.6 kips 796.6 kips

Initial loss =  $(\Delta f_p)/(f_p)$

		at midspan	at endspan
layer 1	% =	35.2%	37.5%
layer 2	% =	25.7%	27.4%
layer 3	% =	23.2%	24.8%
layer 4	% =	21.6%	23.1%
layer 5	% =	21.4%	
layer 6	% =	21.6%	
layer 7	% =	21.3%	
layer 8	% =	21.3%	
layer 9	% =		20.1%
layer 10	% =		20.1%
layer 11	% =		20.1%
layer 12	% =		20.1%
layer 13	% =		20.1%
layer 14	% =		20.1%

OK  
OK  
OK  
OK  
OK  
OK  
OK  
OK  
OK  
OK  
OK  
OK  
OK  
OK

**TOTAL LOSSES AT SERVICE LOADS**

Total Losses		at midspan	at endspan
layer 1	$\Delta f_{pT} =$	84.5 ksi	87.1 ksi
layer 2	$\Delta f_{pT} =$	85.3 ksi	87.9 ksi
layer 3	$\Delta f_{pT} =$	85.3 ksi	87.9 ksi
layer 4	$\Delta f_{pT} =$	85.3 ksi	87.9 ksi
layer 5	$\Delta f_{pT} =$	85.3 ksi	
layer 6	$\Delta f_{pT} =$	85.6 ksi	
layer 7	$\Delta f_{pT} =$	85.6 ksi	
layer 8	$\Delta f_{pT} =$	86.0 ksi	
layer 9	$\Delta f_{pT} =$		87.5 ksi
layer 10	$\Delta f_{pT} =$		87.5 ksi
layer 11	$\Delta f_{pT} =$		87.5 ksi
layer 12	$\Delta f_{pT} =$		87.5 ksi
layer 13	$\Delta f_{pT} =$		87.5 ksi
layer 14	$\Delta f_{pT} =$		87.5 ksi

Stress in tendon after all losses =  $f_{pe} - \Delta f_{pT}$

		at midspan	at endspan
layer 1	$f_{pe} =$	25.6 ksi	23.0 ksi
layer 2	$f_{pe} =$	68.4 ksi	65.7 ksi
layer 3	$f_{pe} =$	85.0 ksi	82.3 ksi
layer 4	$f_{pe} =$	97.4 ksi	94.8 ksi
layer 5	$f_{pe} =$	99.5 ksi	
layer 6	$f_{pe} =$	99.1 ksi	
layer 7	$f_{pe} =$	101.2 ksi	
layer 8	$f_{pe} =$	102.9 ksi	
layer 9	$f_{pe} =$		120.1 ksi
layer 10	$f_{pe} =$		120.1 ksi
layer 11	$f_{pe} =$		120.1 ksi
layer 12	$f_{pe} =$		120.1 ksi
layer 13	$f_{pe} =$		120.1 ksi
layer 14	$f_{pe} =$		120.1 ksi

check prestressing stress limit at service limit state:  $f_{pe} \leq 0.8 \cdot f_{py}$

layer 1	=	119.8 ksi
layer 2	=	157.7 ksi
layer 3	=	163.7 ksi
layer 4	=	173.7 ksi
layer 5	=	175.7 ksi
layer 6	=	179.7 ksi
layer 7	=	181.7 ksi
layer 8	=	183.7 ksi
layer 9	=	199.7 ksi
layer 10	=	199.7 ksi
layer 11	=	199.7 ksi
layer 12	=	199.7 ksi
layer 13	=	199.7 ksi
layer 14	=	199.7 ksi

OK  
OK  
OK  
OK  
OK  
OK  
OK  
OK  
OK  
OK  
OK  
OK  
OK  
OK

force per strand =  $f_{pe}$  \* strand area

		at midspan	at endspan
layer 1	=	3.9 kips	3.5 kips
layer 2	=	10.5 kips	10.1 kips
layer 3	=	13.0 kips	12.6 kips
layer 4	=	14.9 kips	14.5 kips
layer 5	=	15.2 kips	
layer 6	=	15.2 kips	
layer 7	=	15.5 kips	
layer 8	=	15.7 kips	
layer 9	=		18.4 kips
layer 10	=		18.4 kips
layer 11	=		18.4 kips
layer 12	=		18.4 kips
layer 13	=		18.4 kips
layer 14	=		18.4 kips

Total prestressing force after all losses  $P_{pe}$  =

	at midspan	at endspan
$P_{pe}$ =	459.3 kips	487.9 kips

Final losses, % =  $(\Delta f_{pi}) / (f_{pi})$

		at midspan	at endspan
layer 1	% =	76.8%	79.1%
layer 2	% =	77.5%	79.9%
layer 3	% =	77.5%	79.9%
layer 4	% =	77.5%	79.9%
layer 5	% =	77.5%	
layer 6	% =	77.8%	
layer 7	% =	77.8%	
layer 8	% =	78.2%	
layer 9	% =		79.5%
layer 10	% =		79.5%
layer 11	% =		79.5%
layer 12	% =		79.5%
layer 13	% =		79.5%
layer 14	% =		79.5%
Average final losses, %	% =	77.6%	79.6%

### Stresses at Transfer

#### STRESS LIMITS FOR CONCRETE

Compression = $0.6f_{ci}$	$f_{ci}$ =	3.300 ksi
Tension		
without bonded reinforcement = $-0.0948\sqrt{f_{ci}} \leq -0.2$	=	-0.200 ksi
with bonded auxiliary reinforcement = $-0.22\sqrt{f_{ci}}$	=	-0.016 ksi

#### STRESSES AT TRANSFER LENGTH SECTION

Transfer Length = $60 \times$ (strand diameter)	=	2.5 ft	} Calcs for eccentricity (see 9.6.7.2)
Bending moment at transfer length	$M_g$ =	116.4 ft-kips	
center of 12 strands to top fiber of beam at the end	=	7.00 in	
center of 12 strands to bottom fiber of beam at the harp point	=	11.00 in	
center of 12 strands and top fiber of beam at transfer length	=	10.78 in	
center of gravity of 32 strands and bottom fiber of beam	=	3.88 in	
center of gravity of all strands and the bottom fiber of beam at transfer length	=	19.51 in	
center of gravity of all strands and the bottom fiber of beam at the end	=	20.55 in	
Eccentricity of the strand group at transfer length:	$e_n$ =	31.62 in	
Eccentricity at end of beam:	$e$ =	30.58 in	

$$f_t = \frac{P_i}{A} - \frac{P_i e}{S_t} + \frac{M_g}{S_t}$$

$$f_b = \frac{P_i}{A} + \frac{P_i e}{S_b} - \frac{M_g}{S_b}$$

		at midspan	at endspan
Top stress at top fiber of beam	$f_t$ =	-0.482 ksi	-0.504 ksi
Bottom stress at bottom fiber of the beam	$f_b$ =	3.121 ksi	3.121 ksi

OK  
OK

STRESSES AT HARP POINT			
Bending moment due to beam weight at 0.3L	$M_g =$	1188.0 ft-kips	
Top stress at top fiber of beam	$f_t =$	-0.330 ksi	-0.378 ksi
Bottom stress at bottom fiber of the beam	$f_b =$	3.121 ksi	2.503 ksi

OK  
OK

STRESSES AT MIDSPAN			
Bending moment due to beam weight at 0.5L	$M_g =$	1414.3 ft-kips	
Top stress at top fiber of beam	$f_t =$	-0.434 ksi	-0.201 ksi
Bottom stress at bottom fiber of the beam	$f_b =$	2.939 ksi	2.321 ksi

OK  
OK

#### HOLD-DOWN FORCES

assume stress in strand before losses =  $0.8f_u$

layer 1	=	117.4 ksi
layer 2	=	163.9 ksi
layer 3	=	181.6 ksi
layer 4	=	194.9 ksi
layer 5	=	197.1 ksi
layer 6	=	197.1 ksi
layer 7	=	199.3 ksi
layer 8	=	201.5 ksi
layer 9	=	221.4 ksi
layer 10	=	221.4 ksi
layer 11	=	221.4 ksi
layer 12	=	221.4 ksi
layer 13	=	221.4 ksi
layer 14	=	221.4 ksi

prestress force per strand before any losses:

layer 1	=	18.0 kips
layer 2	=	25.1 kips
layer 3	=	27.8 kips
layer 4	=	29.8 kips
layer 5	=	30.2 kips
layer 6	=	30.2 kips
layer 7	=	30.5 kips
layer 8	=	30.8 kips
layer 9	=	33.9 kips
layer 10	=	33.9 kips
layer 11	=	33.9 kips
layer 12	=	33.9 kips
layer 13	=	33.9 kips
layer 14	=	33.9 kips
Harp Angle	$\psi =$	7.2 °

Hold-down force/strand

layer 1	=	2.4 kips/strand
layer 2	=	3.3 kips/strand
layer 3	=	3.6 kips/strand
layer 4	=	3.9 kips/strand
layer 5	=	4.0 kips/strand
layer 6	=	4.0 kips/strand
layer 7	=	4.0 kips/strand
layer 8	=	4.0 kips/strand
layer 9	=	4.4 kips/strand
layer 10	=	4.4 kips/strand
layer 11	=	4.4 kips/strand
layer 12	=	4.4 kips/strand
layer 13	=	4.4 kips/strand
layer 14	=	4.4 kips/strand
Total hold-down force	=	47.07 kips

### Stresses at Service Loads

#### STRESS LIMITS FOR CONCRETE

##### Compression:

Due to permanent loads for load combination Service I

for the precast beam	=	2.457 ksi
for deck	=	1.800 ksi

Due to permanent and transient loads for load combination Service I

for the precast beam	=	3.276 ksi
for deck	=	2.400 ksi

##### Tension:

Load Combination Service III

for the precast beam	=	-0.014 ksi
----------------------	---	------------

#### STRESSES AT MIDSPAN

Compression stresses at top fiber of beam	at midspan	at endspan		
$f_t = \frac{P_{ps}}{A} - \frac{P_{ps}e}{S_t} + \frac{(M_x + M_{s1})}{S_t} + \frac{(M_w + M_b)}{S_{tw}}$				
Due to permanent loads	$f_{tg} =$	2.033 ksi	1.986 ksi	OK
$f_{tr} = \frac{P_{ps}}{A} - \frac{P_{ps}e}{S_t} + \frac{(M_x + M_{s1})}{S_t} + \frac{(M_w - M_b)}{S_{tw}} + \frac{(M_{t2+1})}{S_{tr}}$				
Due to permanent loads and transient loads	$f_{tg} =$	2.523 ksi	2.476 ksi	OK
Compression stresses at top fiber of deck	at midspan	at endspan		
$f_{tc} = \frac{(M_w + M_b)}{S_{tr}}$				
Due to permanent loads	$f_{tc} =$	0.077 ksi	0.077 ksi	OK
$f_{tr} = \frac{(M_w + M_b + M_{t2+1})}{S_{tr}}$				
Due to permanent loads and transient loads	$f_{tc} =$	0.883 ksi	0.883 ksi	OK
Tension stresses at top fiber of deck	at midspan	at endspan		
$f_{tr} = \frac{P_{ps}}{A} + \frac{P_{ps}e}{S_b} - \frac{(M_x + M_{s1})}{S_b} - \frac{(M_w + M_b + 0.8 * M_{t2+1})}{S_{tr}}$				
Load Combination Service III	$f_b =$	-4.041 ksi	-3.917 ksi	OK

### Strength Limit State

#### POSITIVE MOMENT SECTION

$M_u = 1.25DC + 1.5DW + 1.75(LL + IM)$	$M_u =$	8381.5 ft-kips
--	---------	----------------

effective length factor for compression members

layer 1	k =	0.04
layer 2	k =	0.15
layer 3	k =	0.28
layer 4	k =	0.30
layer 5	k =	0.30
layer 6	k =	0.26
layer 7	k =	0.26
layer 8	k =	0.26
layer 9	k =	0.28
layer 10	k =	0.28
layer 11	k =	0.28
layer 12	k =	0.28
layer 13	k =	0.28
layer 14	k =	0.28
c =		4.3 ft-kips



average stress in prestressing steel

layer 1	$f_{ps} =$	146.4 ksi
layer 2	$f_{ps} =$	204.4 ksi
layer 3	$f_{ps} =$	226.5 ksi
layer 4	$f_{ps} =$	243.0 ksi
layer 5	$f_{ps} =$	245.8 ksi
layer 6	$f_{ps} =$	245.8 ksi
layer 7	$f_{ps} =$	248.6 ksi
layer 8	$f_{ps} =$	251.3 ksi
layer 9	$f_{ps} =$	276.2 ksi
layer 10	$f_{ps} =$	276.2 ksi
layer 11	$f_{ps} =$	276.2 ksi
layer 12	$f_{ps} =$	276.2 ksi
layer 13	$f_{ps} =$	276.2 ksi
layer 14	$f_{ps} =$	276.2 ksi

nominal flexure resistance

$a =$	3.65 in
$M_r = \Phi M_n, \Phi = 1.00$	$\Phi M_n =$ 8210.1 ft-kips
$M = DC+W+LL+IM$	$M =$ 5833.6 ft-kips

NOT OK  
OK

**NEGATIVE MOMENT SECTION**

$M_u = 1.25DC+1.5DW+1.75(LL+IM)$	$M_u =$ 4837.2 ft-kips
$a =$	7.35 in
$\Phi M_n =$	4825.3 ft-kips
$M = DC+W+LL+IM$	$M =$ 2869.7 ft-kips

NOT OK  
OK

**Shear Design**

**CRITICAL SECTION AT 0.59**

$V_u = 1.25DC+1.5DW+1.75(LL+IM)$	$V_u =$ 405.0 kips
$M_u = 1.25DC+1.5DW+1.75(LL+IM)$	$M_u =$ -2684.4 ft-kips
or	
$V_u = 1.25DC+1.5DW+1.75(LL+IM)$	$V_u =$ 364.8 kips
$M_u = 1.25DC+1.5DW+1.75(LL+IM)$	$M_u =$ -2877.0 ft-kips
max shear	$V_u =$ 405.0 kips
max moment	$M_u =$ 2877.0 ft-kips
Shear depth	$d_v =$ 73.19 in
Applied factored normal force at the section	$N_u =$ 0
Angle of diagonal compressive stresses	$\theta =$ 36.00 °

**STRAIN IN FLEXURAL TENSION REINFORCEMENT**

$$\epsilon_s = \frac{\frac{M_u}{d_v} + 0.5N_u + 0.25V_u \cot \theta + A_{ps}j_{ps}}{E_s A_s + E_p A_{ps}} \leq 0.002$$

resultant compressive stress at centroid

	<b>at midspan</b>	<b>at endspan</b>
$f_{pc} =$	0.193 ksi	0.175 ksi

effective stress in prestressing strand after all losses

layer 1	$f_{po} =$	26.7 ksi	24.0 ksi
layer 2	$f_{po} =$	69.5 ksi	66.7 ksi
layer 3	$f_{po} =$	86.1 ksi	83.4 ksi
layer 4	$f_{po} =$	98.6 ksi	95.8 ksi
layer 5	$f_{po} =$	100.6 ksi	
layer 6	$f_{po} =$	100.3 ksi	
layer 7	$f_{po} =$	102.3 ksi	
layer 8	$f_{po} =$	104.0 ksi	
layer 9	$f_{po} =$		121.1 ksi
layer 10	$f_{po} =$		121.1 ksi
layer 11	$f_{po} =$		121.1 ksi
layer 12	$f_{po} =$		121.1 ksi
layer 13	$f_{po} =$		121.1 ksi
layer 14	$f_{po} =$		121.1 ksi

strain in flexural tension

		at midspan	at endspan
layer 1	$\epsilon_x =$	0.002000	0.002000
layer 2	$\epsilon_x =$	0.002000	0.002000
layer 3	$\epsilon_x =$	0.002000	0.002000
layer 4	$\epsilon_x =$	0.002000	0.002000
layer 5	$\epsilon_x =$	0.002000	
layer 6	$\epsilon_x =$	0.002000	
layer 7	$\epsilon_x =$	0.002000	
layer 8	$\epsilon_x =$	0.002000	
layer 9	$\epsilon_x =$		0.002000
layer 10	$\epsilon_x =$		0.002000
layer 11	$\epsilon_x =$		0.002000
layer 12	$\epsilon_x =$		0.002000
layer 13	$\epsilon_x =$		0.002000
layer 14	$\epsilon_x =$		0.002000

### Deflection and Camber

		at midspan	at endspan
Deflection due to Prestressing Force at Transfer	$\Delta_p =$	3.97 in	3.97 in
Deflection due to Beam Self-Weight at Transfer	$\Delta_g =$	-3.79 in	
Deflection due to Beam Self-Weight at Erection	$\Delta_g =$	-3.68 in	
Deflection due to Haunch and Deck	$\Delta_s =$	-5.63 in	
Deflection due to total self weight	$\Delta_{sw} =$	-5.34 in	
Total Deflection at transfer	$\Delta =$	0.18 in	0.18 in
Total Deflection at erection	$\Delta =$	0.34 in	0.34 in
Live load deflection limit = span/800	$=$	-1.80 in	
Deflection due to live load and impact	$\Delta_L =$	-2.18 in	
Deflection due to fire truck	$\Delta_L =$	-4.1776 in	
Total Deflection after fire with fire truck	$\Delta =$	-5.5481 in	

NOT OK

NOT OK

**Location: Fire at Critical Positive Moment Sections**  
**Beam Design: 3/8" Strand**  
**Fire Exposure Status: Undamaged**

(PCI Bridge Design Manual Section 9.6)

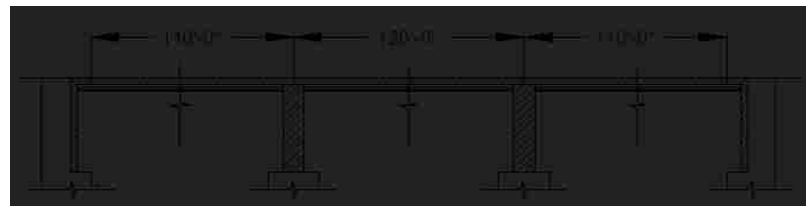


**Material Properties**

CAST-IN-PLACE SLAB			
Actual Thickness	$t_{as} =$		8.0 in
Wearing Surface	$=$		0.5 in
Structural thickness = Actual - Wearing Surface	$t_s =$		7.5 in
Compressive Strength	$f'_c =$		4 ksi
Unit Weight	$w_c =$		150.0 pcf
Stress factor of compression block	$\beta_1 =$		0.85

BEAMS: AASHTO-PCI, BT-72 BULB-TEE			
Strength at release	$f'_{ci} =$		5.5 ksi
Strength at 28 days	$f'_c =$		7 ksi
Unit Weight	$w_c =$		150.0 pcf
Overall Beam Length:			
@ end spans	$L =$		110 ft
@ center span	$L =$		119 ft
Design Spans:			
Non-composite beam @ end spans	$L =$		109 ft
Non-composite beam @ center span	$L =$		118 ft
Composite beam @ end spans	$L =$		110 ft
Composite beam @ center span	$L =$		120 ft
Beam Spacing	$S =$		12 ft



**PRESTRESSING STRANDS**

Diameter of single strand	d =	0.4 in
Area of single strand	A =	0.085 in <sup>2</sup>

Temperature of Layer

layer 1 (bottom)	T =	68.00 °F
layer 2	T =	68.00 °F
layer 3	T =	68.00 °F
layer 4	T =	68.00 °F
layer 5	T =	68.00 °F
layer 6	T =	68.00 °F
layer 7	T =	68.00 °F
layer 8	T =	68.00 °F
layer 9	T =	68.00 °F
layer 10	T =	68.00 °F
layer 11	T =	68.00 °F
layer 12	T =	68.00 °F
layer 13	T =	68.00 °F
layer 14	T =	68.00 °F

Ultimate Strength

initial = 284 ksi

layer 1 (bottom)	f <sub>pu</sub> =	284 ksi
layer 2	f <sub>pu</sub> =	284 ksi
layer 3	f <sub>pu</sub> =	284 ksi
layer 4	f <sub>pu</sub> =	284 ksi
layer 5	f <sub>pu</sub> =	284 ksi
layer 6	f <sub>pu</sub> =	284 ksi
layer 7	f <sub>pu</sub> =	284 ksi
layer 8	f <sub>pu</sub> =	284 ksi
layer 9	f <sub>pu</sub> =	284 ksi
layer 10	f <sub>pu</sub> =	284 ksi
layer 11	f <sub>pu</sub> =	284 ksi
layer 12	f <sub>pu</sub> =	284 ksi
layer 13	f <sub>pu</sub> =	284 ksi
layer 14	f <sub>pu</sub> =	284 ksi

Yield Strength

initial = 257 ksi

layer 1 (bottom)	f <sub>py</sub> =	257 ksi
layer 2	f <sub>py</sub> =	257 ksi
layer 3	f <sub>py</sub> =	257 ksi
layer 4	f <sub>py</sub> =	257 ksi
layer 5	f <sub>py</sub> =	257 ksi
layer 6	f <sub>py</sub> =	257 ksi
layer 7	f <sub>py</sub> =	257 ksi
layer 8	f <sub>py</sub> =	257 ksi
layer 9	f <sub>py</sub> =	257 ksi
layer 10	f <sub>py</sub> =	257 ksi
layer 11	f <sub>py</sub> =	257 ksi
layer 12	f <sub>py</sub> =	257 ksi
layer 13	f <sub>py</sub> =	257 ksi
layer 14	f <sub>py</sub> =	257 ksi

**Stress Limits:**

before transfer ≤ 0.75f<sub>pu</sub> (initial = 202.5)

layer 1 (bottom)	f <sub>pl</sub> =	213.2 ksi
layer 2	f <sub>pl</sub> =	213.2 ksi
layer 3	f <sub>pl</sub> =	213.2 ksi
layer 4	f <sub>pl</sub> =	213.2 ksi
layer 5	f <sub>pl</sub> =	213.2 ksi
layer 6	f <sub>pl</sub> =	213.2 ksi
layer 7	f <sub>pl</sub> =	213.2 ksi
layer 8	f <sub>pl</sub> =	213.2 ksi
layer 9	f <sub>pl</sub> =	213.2 ksi
layer 10	f <sub>pl</sub> =	213.2 ksi
layer 11	f <sub>pl</sub> =	213.2 ksi
layer 12	f <sub>pl</sub> =	213.2 ksi
layer 13	f <sub>pl</sub> =	213.2 ksi
layer 14	f <sub>pl</sub> =	213.2 ksi

at service limit state (after all losses)  $\leq 0.80f_{py}$  (initial = 194.4)

layer 1 (bottom)	$f_{pe} =$	205.4 ksi
layer 2	$f_{pe} =$	205.4 ksi
layer 3	$f_{pe} =$	205.4 ksi
layer 4	$f_{pe} =$	205.4 ksi
layer 5	$f_{pe} =$	205.4 ksi
layer 6	$f_{pe} =$	205.4 ksi
layer 7	$f_{pe} =$	205.4 ksi
layer 8	$f_{pe} =$	205.4 ksi
layer 9	$f_{pe} =$	205.4 ksi
layer 10	$f_{pe} =$	205.4 ksi
layer 11	$f_{pe} =$	205.4 ksi
layer 12	$f_{pe} =$	205.4 ksi
layer 13	$f_{pe} =$	205.4 ksi
layer 14	$f_{pe} =$	205.4 ksi

Modulus of Elasticity

initial = 25898 ksi

layer 1 (bottom)	E =	25898.0 ksi
layer 2	E =	25898.0 ksi
layer 3	E =	25898.0 ksi
layer 4	E =	25898.0 ksi
layer 5	E =	25898.0 ksi
layer 6	E =	25898.0 ksi
layer 7	E =	25898.0 ksi
layer 8	E =	25898.0 ksi
layer 9	E =	25898.0 ksi
layer 10	E =	25898.0 ksi
layer 11	E =	25898.0 ksi
layer 12	E =	25898.0 ksi
layer 13	E =	25898.0 ksi
layer 14	E =	25898.0 ksi

#### REINFORCING BARS

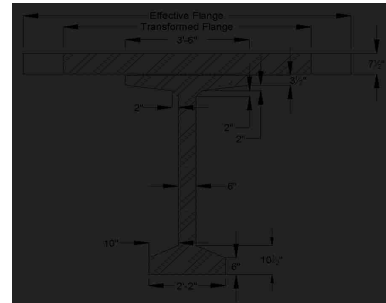
Yield Strength	$f_y =$	57.6 ksi
Modulus of Elasticity	E =	29000.0 ksi

Area of steel at endspan (effective flange)	$A_{se} =$	15.4 in <sup>2</sup>
Area of steel at midspan (effective flange)	$A_{sm} =$	0.0 in <sup>2</sup>
Area of temperature and shrinkage steel (12" width)	$A_s =$	0.0 in <sup>2</sup>

#### Cross-sectional Properties

##### NON-COMPOSITE BEAM

Area of cross-section of beam	A =	767.0 in <sup>2</sup>
Overall depth of beam	H =	72.0 in
Moment of Inertia	I =	539,947 in <sup>4</sup>
Distance from centroid to extreme <b>bottom</b> fiber	$y_b =$	36.6 in
Distance from centroid to extreme <b>top</b> fiber	$y_t =$	35.4 in
Section modulus for the extreme <b>bottom</b> fiber	$S_b =$	14915.0 in <sup>3</sup>
Section modulus for the extreme <b>top</b> fiber	$S_t =$	15421.0 in <sup>3</sup>
Weight	$W_t =$	799.0 plf
Modulus of Elasticity = $33000 \cdot (W_c \cdot 1.5) \cdot (\sqrt{f'_c})$		
cast-in-place concrete deck	$E_{cs} =$	3834 ksi
precast beam at release	$E_{ci} =$	4496 ksi
precast beam at service loads	$E_c =$	5072 ksi



**COMPOSITE BEAM AT MIDSPAN**

Effective Flange Width	$b_f =$	111.0 in	*min of three criteria
Modular Ratio = $E_{cs}/E_c$	$n =$	0.7559	
Transformed flange width	$=$	83.9 in	
Transformed flange area	$=$	629.3 in <sup>2</sup>	
Transformed haunch width	$=$	31.7 in	
Transformed haunch area	$=$	15.9 in <sup>2</sup>	

	Transformed Area	$y_b$	$Ay_b$	$A(y_{bc}-y_b)^2$	$I$	$I + A(y_{bc}-y_b)^2$
Beam	767.0 in <sup>2</sup>	36.60 in	28,072.2 in <sup>3</sup>	250,443 in <sup>4</sup>	539,947 in <sup>4</sup>	790,390 in <sup>4</sup>
Haunch	15.9 in <sup>2</sup>	72.25 in	1,146.9 in <sup>3</sup>	4,906 in <sup>4</sup>	0.33 in <sup>4</sup>	4,906 in <sup>4</sup>
Deck	629.3 in <sup>2</sup>	76.25 in	47,985.0 in <sup>3</sup>	293,069 in <sup>4</sup>	2,950 in <sup>4</sup>	296,019 in <sup>4</sup>
Total	1412.2 in <sup>2</sup>		77,204.1 in <sup>3</sup>			1,091,315 in <sup>4</sup>

Total area of Composite Section	$A_c =$	1412 in <sup>2</sup>
Overall Depth of the Composite Section	$h_c =$	80 in
Moment of Inertia	$I_c =$	1,091,315 in <sup>4</sup>
Distance from centroid to extreme <u>bottom</u> fiber of beam	$y_{bc} =$	54.67 in
Distance from centroid to extreme <u>top</u> fiber of beam	$y_{tb} =$	17.33 in
Distance from centroid to extreme <u>top</u> fiber of slab	$y_{lc} =$	25.33 in
Section modulus for the extreme <u>bottom</u> fiber of beam	$S_{bc} =$	19,961.9 in <sup>3</sup>
Section modulus for the extreme <u>top</u> fiber of beam	$S_{tb} =$	62,972.4 in <sup>3</sup>
Section modulus for the extreme <u>top</u> fiber slab	$S_{lc} =$	56,994.5 in <sup>3</sup>

**Shear Forces and Bending Moments**

**DEAD LOADS**

Beam self-weight	$w_{beam} =$	0.799 k/f
8 in. deck weight	$w_{deck} =$	1.200 k/f
1/2 in. haunch weight	$w_{haunch} =$	0.022 k/f

LRFD Specifications: Art. 4.6.2.2.1

Width of Deck Constant		OK
Number of beams is not less than four $N_b =$	4	OK
Roadway part of the overhang, $d_e \leq 3.0$ ft, $d_e =$	1.5	OK
Curvature in plans is less than $4^\circ =$	0	OK
Cross-section of the bridge is consistent with one of the cross sections given by LRFD specs		OK

Barrier and wearing surface loads are equally distributed among the 4 beams

Barrier Wt	$Wt =$	0.150 k/f
Dead load of future wearing surface	$DW =$	0.263 k/f

**LIVE LOADS**

Fire truck live load front load (Point A)	$P_{live} =$	48.0 kips
Fire truck live load back load (Point B)	$P_{live} =$	22.0 kips
distance between two loads		19.2 ft
distance from nearest edge to point A	$x_a =$	59.0 ft
distance from nearest edge to point B	$x_b =$	39.8 ft

LRFD Specifications: Art. 4.6.2.2.1

Width of Deck Constant		OK
Number of beams is not less than four $N_b =$	4	OK
Beams are parallel and approximately of the same stiffness		OK
Roadway part of the overhang, $d_e \leq 3.0$ ft, $d_e =$	1.5	OK
Curvature in plans is less than $4^\circ =$	0	OK

Barrier and wearing surface loads are equally distributed among the 4 beams

Bridge Type-- "k" (LRFD Table 4.6.2.2.1-1)

Number of design lanes = $w/12$	$=$	3 lanes
---------------------------------	-----	---------

**Distribution Factor for Bending Moment:**

Beams spacing	S =	12.0 ft
Depth of concrete slab	t <sub>s</sub> =	7.5 in
Beam Span	L =	120.0 ft
Number of Beams	N <sub>b</sub> =	4
Modular ratio between beam & deck materials	n =	1.3229
Longitudinal stiffness parameter	K <sub>y</sub> =	2,309,429.79 in <sup>4</sup>

at center span:

$$DFM = 0.75 + \left(\frac{S}{9.5}\right)^{0.4} * \left(\frac{S}{L}\right)^{0.3} * \left(\frac{K_y}{12 * L * t_s^3}\right)^{0.1}$$

DFM =	0.905 lanes/beam
-------	------------------

one design lane loaded:

$$DFM = 0.75 + \left(\frac{S}{14}\right)^{0.4} * \left(\frac{S}{L}\right)^{0.3} * \left(\frac{K_y}{12 * L * t_s^3}\right)^{0.1}$$

DFM =	0.614 lanes/beam
-------	------------------

0.905 Controls

**Distribution Factor for Shear Force**

both end spans and center span:

$$DFV = 0.2 + \left(\frac{S'}{12}\right) - \left(\frac{S'}{35}\right)^2$$

DFV =	1.082 lanes/beam
-------	------------------

one design lane loaded:

$$DFV = 0.36 + \left(\frac{S'}{25}\right)$$

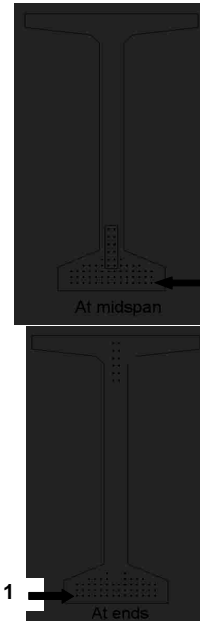
DFV =	0.840 lanes/beam
-------	------------------

1.082 Controls

from bottom	At Midspan		At Ends	
	No. of	Distance from Bottom	No. of	Distance from Bottom
layer 1	14	2	14	2
layer 2	14	3.5	14	3.5
layer 3	14	5	14	5
layer 4	10	6.5	8	6.5
layer 5	4	8	2	8
layer 6	2	10	-	-
layer 7	2	12	-	-
layer 8	2	14	-	-
layer 9	2	16	2	60
layer 10	-	-	2	62
layer 11	-	-	2	64
layer 12	-	-	2	66
layer 13	-	-	2	68
layer 14	-	-	2	70
	64		64	
<b>Harped Strand Group (included in above totals)</b>				
layer 3	2	6		
layer 4	2	8		
layer 5	2	10		
layer 6	2	12		
layer 7	2	14		
layer 8	2	16		

distance from the center of gravity of strands to the bottom fiber of the beam = 7% of the beam depth  
strand eccentricity at midspan = (y<sub>c</sub> - y<sub>bs</sub>)

y <sub>bs</sub> =	5.44 in
e <sub>c</sub> =	31.16 in



## Prestress Losses

### ELASTIC SHORTENING

assumed loss	=	6.00%
Force per strand at transfer		
layer 1	=	17.0 kips
layer 2	=	17.0 kips
layer 3	=	17.0 kips
layer 4	=	17.0 kips
layer 5	=	17.0 kips
layer 6	=	17.0 kips
layer 7	=	17.0 kips
layer 8	=	17.0 kips
layer 9	=	17.0 kips
layer 10	=	17.0 kips
layer 11	=	17.0 kips
layer 12	=	17.0 kips
layer 13	=	17.0 kips
layer 14	=	17.0 kips

Total prestressing force at release	$P_1 =$	at midspan 1088.0 kips	at endspan 1054.0 kips
Sum of concrete stresses at the center of gravity of prestressing tendons due to prestressing force at transfer and the self-weight of the member at sections of maximum moment	$f_{cgp} =$	2.412 ksi	2.307 ksi
Loss due to shortening		at midspan	at endspan
layer 1	$\Delta f_{pES} =$	13.9 ksi	13.3 ksi
layer 2	$\Delta f_{pES} =$	13.9 ksi	13.3 ksi
layer 3	$\Delta f_{pES} =$	13.9 ksi	13.3 ksi
layer 4	$\Delta f_{pES} =$	13.9 ksi	13.3 ksi
layer 5	$\Delta f_{pES} =$	13.9 ksi	13.3 ksi
layer 6	$\Delta f_{pES} =$	13.9 ksi	
layer 7	$\Delta f_{pES} =$	13.9 ksi	
layer 8	$\Delta f_{pES} =$	13.9 ksi	
layer 9	$\Delta f_{pES} =$	13.9 ksi	13.3 ksi
layer 10	$\Delta f_{pES} =$		13.3 ksi
layer 11	$\Delta f_{pES} =$		13.3 ksi
layer 12	$\Delta f_{pES} =$		13.3 ksi
layer 13	$\Delta f_{pES} =$		13.3 ksi
layer 14	$\Delta f_{pES} =$		13.3 ksi

### SHRINKAGE

Shrinkage = $(17 - 0.15 \cdot \text{Relative Humidity})$	$\Delta f_{pSR} =$	6.5 ksi	← assume relative humidity = 70%
--	--------------------	---------	----------------------------------

### CREEP OF CONCRETE

Change of stresses at center of gravity of prestressing due to permanent loads except the loads acting at time of applying prestressing force, calculated at the same section as $f_{cgp}$	$\Delta f_{cgp} =$	1.582 ksi	
loss due to creep	$\Delta f_{pCR} =$	at midspan 17.9 ksi	at endspan 16.6 ksi



**RELAXATION OF PRESTRESSING STRANDS**

loss due to relaxation after transfer		at midspan	at endspan
layer 1	$\Delta f_{pR2} =$	2.9 ksi	2.9 ksi
layer 2	$\Delta f_{pR2} =$	2.9 ksi	2.9 ksi
layer 3	$\Delta f_{pR2} =$	2.9 ksi	2.9 ksi
layer 4	$\Delta f_{pR2} =$	2.9 ksi	2.9 ksi
layer 5	$\Delta f_{pR2} =$	2.9 ksi	2.9 ksi
layer 6	$\Delta f_{pR2} =$	2.9 ksi	
layer 7	$\Delta f_{pR2} =$	2.9 ksi	
layer 8	$\Delta f_{pR2} =$	2.9 ksi	
layer 9	$\Delta f_{pR2} =$	2.9 ksi	2.9 ksi
layer 10	$\Delta f_{pR2} =$		2.9 ksi
layer 11	$\Delta f_{pR2} =$		2.9 ksi
layer 12	$\Delta f_{pR2} =$		2.9 ksi
layer 13	$\Delta f_{pR2} =$		2.9 ksi
layer 14	$\Delta f_{pR2} =$		2.9 ksi

**TOTAL LOSSES AT TRANSFER**

total loss  $\Delta f_{pES} = \Delta f_{pt}$

stress in tendons after transfer  $f_{pt} = f_{pr} - \Delta f_{pt}$

		at midspan	at endspan
layer 1	$f_{pt} =$	199.3 ksi	199.9 ksi
layer 2	$f_{pt} =$	199.3 ksi	199.9 ksi
layer 3	$f_{pt} =$	199.3 ksi	199.9 ksi
layer 4	$f_{pt} =$	199.3 ksi	199.9 ksi
layer 5	$f_{pt} =$	199.3 ksi	199.9 ksi
layer 6	$f_{pt} =$	199.3 ksi	
layer 7	$f_{pt} =$	199.3 ksi	
layer 8	$f_{pt} =$	199.3 ksi	
layer 9	$f_{pt} =$	199.3 ksi	199.9 ksi
layer 10	$f_{pt} =$		199.9 ksi
layer 11	$f_{pt} =$		199.9 ksi
layer 12	$f_{pt} =$		199.9 ksi
layer 13	$f_{pt} =$		199.9 ksi
layer 14	$f_{pt} =$		199.9 ksi

force per strand =  $f_{pt} \cdot \text{strand area}$

		at midspan	at endspan
layer 1	=	16.9 kips	17.0 kips
layer 2	=	16.9 kips	17.0 kips
layer 3	=	16.9 kips	17.0 kips
layer 4	=	16.9 kips	17.0 kips
layer 5	=	16.9 kips	17.0 kips
layer 6	=	16.9 kips	
layer 7	=	16.9 kips	
layer 8	=	16.9 kips	
layer 9	=	16.9 kips	17.0 kips
layer 10	=		17.0 kips
layer 11	=		17.0 kips
layer 12	=		17.0 kips
layer 13	=		17.0 kips
layer 14	=		17.0 kips

Total prestressing force after transfer  $P_i =$  1047.8 kips 1054.0 kips

Initial loss =  $(\Delta f_p)/(f_{pi})$

		at midspan	at endspan
layer 1	% =	6.5%	6.2%
layer 2	% =	6.5%	6.2%
layer 3	% =	6.5%	6.2%
layer 4	% =	6.5%	6.2%
layer 5	% =	6.5%	6.2%
layer 6	% =	6.5%	
layer 7	% =	6.5%	
layer 8	% =	6.5%	
layer 9	% =	6.5%	6.2%
layer 10	% =		6.2%
layer 11	% =		6.2%
layer 12	% =		6.2%
layer 13	% =		6.2%
layer 14	% =		6.2%

OK  
OK  
OK  
OK  
OK  
OK  
OK  
OK  
OK  
OK  
OK  
OK  
OK  
OK

**TOTAL LOSSES AT SERVICE LOADS**

Total Losses		at midspan	at endspan
layer 1	$\Delta f_{pT} =$	41.1 ksi	40.5 ksi
layer 2	$\Delta f_{pT} =$	41.1 ksi	40.5 ksi
layer 3	$\Delta f_{pT} =$	41.1 ksi	40.5 ksi
layer 4	$\Delta f_{pT} =$	41.1 ksi	40.5 ksi
layer 5	$\Delta f_{pT} =$	41.1 ksi	40.5 ksi
layer 6	$\Delta f_{pT} =$	41.1 ksi	
layer 7	$\Delta f_{pT} =$	41.1 ksi	
layer 8	$\Delta f_{pT} =$	41.1 ksi	
layer 9	$\Delta f_{pT} =$	41.1 ksi	40.5 ksi
layer 10	$\Delta f_{pT} =$		40.5 ksi
layer 11	$\Delta f_{pT} =$		40.5 ksi
layer 12	$\Delta f_{pT} =$		40.5 ksi
layer 13	$\Delta f_{pT} =$		40.5 ksi
layer 14	$\Delta f_{pT} =$		40.5 ksi

Stress in tendon after all losses =  $f_{pi} - \Delta f_{pT}$

		at midspan	at endspan
layer 1	$f_{pe} =$	172.0 ksi	172.6 ksi
layer 2	$f_{pe} =$	172.0 ksi	172.6 ksi
layer 3	$f_{pe} =$	172.0 ksi	172.6 ksi
layer 4	$f_{pe} =$	172.0 ksi	172.6 ksi
layer 5	$f_{pe} =$	172.0 ksi	172.6 ksi
layer 6	$f_{pe} =$	172.0 ksi	
layer 7	$f_{pe} =$	172.0 ksi	
layer 8	$f_{pe} =$	172.0 ksi	
layer 9	$f_{pe} =$	172.0 ksi	172.6 ksi
layer 10	$f_{pe} =$		172.6 ksi
layer 11	$f_{pe} =$		172.6 ksi
layer 12	$f_{pe} =$		172.6 ksi
layer 13	$f_{pe} =$		172.6 ksi
layer 14	$f_{pe} =$		172.6 ksi

check prestressing stress limit at service limit state:  $f_{pe} \leq 0.8 \cdot f_{py}$

layer 1	=	205.4 ksi
layer 2	=	205.4 ksi
layer 3	=	205.4 ksi
layer 4	=	205.4 ksi
layer 5	=	205.4 ksi
layer 6	=	205.4 ksi
layer 7	=	205.4 ksi
layer 8	=	205.4 ksi
layer 9	=	205.4 ksi
layer 10	=	205.4 ksi
layer 11	=	205.4 ksi
layer 12	=	205.4 ksi
layer 13	=	205.4 ksi
layer 14	=	205.4 ksi

OK  
OK  
OK  
OK  
OK  
OK  
OK  
OK  
OK  
OK  
OK  
OK  
OK  
OK

force per strand =  $f_{pe}$  \* strand area

		at midspan	at endspan
layer 1	=	14.6 kips	14.7 kips
layer 2	=	14.6 kips	14.7 kips
layer 3	=	14.6 kips	14.7 kips
layer 4	=	14.6 kips	14.7 kips
layer 5	=	14.6 kips	14.7 kips
layer 6	=	14.6 kips	
layer 7	=	14.6 kips	
layer 8	=	14.6 kips	
layer 9	=	14.6 kips	14.7 kips
layer 10	=		14.7 kips
layer 11	=		14.7 kips
layer 12	=		14.7 kips
layer 13	=		14.7 kips
layer 14	=		14.7 kips

Total prestressing force after all losses  $P_{pe}$  =  
 Final losses, % =  $(\Delta f_{pt}) / (f_{pi})$

		at midspan	at endspan
$P_{pe}$ =		935.7 kips	939.1 kips

layer 1	% =	19.3%	19.0%
layer 2	% =	19.3%	19.0%
layer 3	% =	19.3%	19.0%
layer 4	% =	19.3%	19.0%
layer 5	% =	19.3%	19.0%
layer 6	% =	19.3%	
layer 7	% =	19.3%	
layer 8	% =	19.3%	
layer 9	% =	19.3%	19.0%
layer 10	% =		19.0%
layer 11	% =		19.0%
layer 12	% =		19.0%
layer 13	% =		19.0%
layer 14	% =		19.0%
Average final losses, %	% =	19.3%	19.0%

### Stresses at Transfer

#### STRESS LIMITS FOR CONCRETE

Compression = $0.6f_{ci}$	$f_{ci}$ =	3.300 ksi
Tension		
without bonded reinforcement = $-0.0948 \sqrt{f_{ci}} \leq -0.2$	=	-0.200 ksi
with bonded auxiliary reinforcement = $-0.22 \sqrt{f_{ci}}$	=	-0.016 ksi

#### STRESSES AT TRANSFER LENGTH SECTION

Transfer Length = $60 \times$ (strand diameter)	=	1.9 ft	} Calcs for eccentricity (see 9.6.7.2)
Bending moment at transfer length	$M_g$ =	87.7 ft-kips	
center of 12 strands to top fiber of beam at the end	=	7.00 in	
center of 12 strands to bottom fiber of beam at the harp point	=	11.00 in	
center of 12 strands and top fiber of beam at transfer length	=	9.84 in	
center of gravity of 32 strands and bottom fiber of beam	=	3.98 in	
center of gravity of all strands and the bottom fiber of beam at transfer length	=	15.24 in	
center of gravity of all strands and the bottom fiber of beam at the end	=	15.30 in	
Eccentricity of the strand group at transfer length:	$e_n$ =	21.36 in	}
Eccentricity at end of beam:	$e$ =	21.30 in	

$$f_t = \frac{P_i}{A} - \frac{P_i e}{S_t} + \frac{M_f}{S_t}$$

$$f_b = \frac{P_i}{A} + \frac{P_i e}{S_b} - \frac{M_f}{S_b}$$

		at midspan	at endspan
Top stress at top fiber of beam	$f_t$ =	-0.017 ksi	-0.017 ksi
Bottom stress at bottom fiber of the beam	$f_b$ =	2.906 ksi	2.906 ksi

OK  
OK

STRESSES AT HARP POINT			
Bending moment due to beam weight at 0.3L	$M_g =$	1188.0 ft-kips	
Top stress at top fiber of beam	$f_t =$	0.173 ksi	0.169 ksi
Bottom stress at bottom fiber of the beam	$f_b =$	2.736 ksi	2.621 ksi

OK  
OK

STRESSES AT MIDSPAN			
Bending moment due to beam weight at 0.5L	$M_g =$	1414.3 ft-kips	
Top stress at top fiber of beam	$f_t =$	0.320 ksi	0.345 ksi
Bottom stress at bottom fiber of the beam	$f_b =$	2.554 ksi	2.438 ksi

OK  
OK

#### HOLD-DOWN FORCES

assume stress in strand before losses =  $0.8f_u$

layer 1	=	227.4 ksi
layer 2	=	227.4 ksi
layer 3	=	227.4 ksi
layer 4	=	227.4 ksi
layer 5	=	227.4 ksi
layer 6	=	227.4 ksi
layer 7	=	227.4 ksi
layer 8	=	227.4 ksi
layer 9	=	227.4 ksi
layer 10	=	227.4 ksi
layer 11	=	227.4 ksi
layer 12	=	227.4 ksi
layer 13	=	227.4 ksi
layer 14	=	227.4 ksi

prestress force per strand before any losses:

layer 1	=	19.3 kips
layer 2	=	19.3 kips
layer 3	=	19.3 kips
layer 4	=	19.3 kips
layer 5	=	19.3 kips
layer 6	=	19.3 kips
layer 7	=	19.3 kips
layer 8	=	19.3 kips
layer 9	=	19.3 kips
layer 10	=	19.3 kips
layer 11	=	19.3 kips
layer 12	=	19.3 kips
layer 13	=	19.3 kips
layer 14	=	19.3 kips
Harp Angle	$\psi =$	7.2 °

Hold-down force/strand

layer 1	=	2.5 kips/strand
layer 2	=	2.5 kips/strand
layer 3	=	2.5 kips/strand
layer 4	=	2.5 kips/strand
layer 5	=	2.5 kips/strand
layer 6	=	2.5 kips/strand
layer 7	=	2.5 kips/strand
layer 8	=	2.5 kips/strand
layer 9	=	2.5 kips/strand
layer 10	=	2.5 kips/strand
layer 11	=	2.5 kips/strand
layer 12	=	2.5 kips/strand
layer 13	=	2.5 kips/strand
layer 14	=	2.5 kips/strand
Total hold-down force	=	30.45 kips

### Stresses at Service Loads

#### STRESS LIMITS FOR CONCRETE

##### Compression:

Due to permanent loads for load combination Service I

for the precast beam	=	3.150 ksi
for deck	=	1.800 ksi

Due to permanent and transient loads for load combination Service I

for the precast beam	=	4.200 ksi
for deck	=	2.400 ksi

##### Tension:

Load Combination Service III

for the precast beam	=	-0.016 ksi
----------------------	---	------------

#### STRESSES AT MIDSPAN

Compression stresses at top fiber of beam	at midspan	at endspan		
$f_t = \frac{P_{ps}}{A} - \frac{P_{ps}e}{S_t} + \frac{(M_w + M_d)}{S_t} + \frac{(M_w + M_d)}{S_{yt}}$				
Due to permanent loads	$f_{t0} =$	2.105 ksi	2.102 ksi	OK
$f_{ty} = \frac{P_{ps}}{A} - \frac{P_{ps}e}{S_t} + \frac{(M_w + M_d)}{S_t} + \frac{(M_w + M_d)}{S_{yt}} + \frac{(M_{LL1})}{S_{yt}}$				
Due to permanent loads and transient loads	$f_{ty} =$	2.508 ksi	2.505 ksi	OK
Compression stresses at top fiber of deck	at midspan	at endspan		
$f_{ts} = \frac{(M_w + M_d)}{S_{tr}}$				
Due to permanent loads	$f_{ts} =$	0.042 ksi	0.042 ksi	OK
$f_{ts} = \frac{(M_w + M_d + M_{LL1})}{S_{tr}}$				
Due to permanent loads and transient loads	$f_{ts} =$	0.488 ksi	0.488 ksi	OK
Tension stresses at top fiber of deck	at midspan	at endspan		
$f_{ty} = \frac{P_{ps}}{A} + \frac{P_{ps}e}{S_b} - \frac{(M_w + M_d)}{S_b} - \frac{(M_w + M_d + 0.8 * M_{LL1})}{S_b}$				
Load Combination Service III	$f_{ty} =$	-0.793 ksi	-0.782 ksi	OK

### Strength Limit State

#### POSITIVE MOMENT SECTION

$M_u = 1.25DC + 1.5DW + 1.75(LL+IM)$	$M_u =$	8381.5 ft-kips
--------------------------------------	---------	----------------

effective length factor for compression members

layer 1	k =	0.27
layer 2	k =	0.27
layer 3	k =	0.27
layer 4	k =	0.27
layer 5	k =	0.27
layer 6	k =	0.27
layer 7	k =	0.27
layer 8	k =	0.27
layer 9	k =	0.27
layer 10	k =	0.27
layer 11	k =	0.27
layer 12	k =	0.27
layer 13	k =	0.27
layer 14	k =	0.27
c =		4.6 ft-kips

average stress in prestressing steel

layer 1	$f_{ps} =$	279.4 ksi
layer 2	$f_{ps} =$	279.4 ksi
layer 3	$f_{ps} =$	279.4 ksi
layer 4	$f_{ps} =$	279.4 ksi
layer 5	$f_{ps} =$	279.4 ksi
layer 6	$f_{ps} =$	279.4 ksi
layer 7	$f_{ps} =$	279.4 ksi
layer 8	$f_{ps} =$	279.4 ksi
layer 9	$f_{ps} =$	279.4 ksi
layer 10	$f_{ps} =$	279.4 ksi
layer 11	$f_{ps} =$	279.4 ksi
layer 12	$f_{ps} =$	279.4 ksi
layer 13	$f_{ps} =$	279.4 ksi
layer 14	$f_{ps} =$	279.4 ksi

nominal flexure resistance

$a =$	3.94 in
$M_r = \Phi M_n, \Phi = 1.00$	$\Phi M_n =$ 9193.8 ft-kips
$M = DC+W+LL+IM$	$M =$ 5833.6 ft-kips

OK  
OK

**NEGATIVE MOMENT SECTION**

$M_u = 1.25DC+1.5DW+1.75(LL+IM)$	$M_u =$ 4837.2 ft-kips
$a =$	5.73 in
$\Phi M_n =$	4879.0 ft-kips
$M = DC+W+LL+IM$	$M =$ 2869.7 ft-kips

OK  
OK

**Shear Design**

**CRITICAL SECTION AT 0.59**

$V_u = 1.25DC+1.5DW+1.75(LL+IM)$	$V_u =$ 405.0 kips
$M_u = 1.25DC+1.5DW+1.75(LL+IM)$	$M_u =$ -2684.4 ft-kips
or	
$V_u = 1.25DC+1.5DW+1.75(LL+IM)$	$V_u =$ 364.8 kips
$M_u = 1.25DC+1.5DW+1.75(LL+IM)$	$M_u =$ -2877.0 ft-kips
max shear	$V_u =$ 405.0 kips
max moment	$M_u =$ 2877.0 ft-kips
Shear depth	$d_v =$ 73.19 in
Applied factored normal force at the section	$N_u =$ 0
Angle of diagonal compressive stresses	$\theta =$ 36.00 °

**STRAIN IN FLEXURAL TENSION REINFORCEMENT**

$$\epsilon_s = \frac{\frac{M_u}{\phi_s} + 0.5A'_s + 0.5V_u \cot \theta}{E_s A_s + E_s A'_s} \leq 0.002$$

resultant compressive stress at centroid

$f_{dc} =$	at midspan	at endspan
	0.909 ksi	0.911 ksi

effective stress in prestressing strand after all losses

layer 1	$f_{po} =$	176.7 ksi	177.3 ksi
layer 2	$f_{po} =$	176.7 ksi	177.3 ksi
layer 3	$f_{po} =$	176.7 ksi	177.3 ksi
layer 4	$f_{po} =$	176.7 ksi	177.3 ksi
layer 5	$f_{po} =$	176.7 ksi	
layer 6	$f_{po} =$	176.7 ksi	
layer 7	$f_{po} =$	176.7 ksi	
layer 8	$f_{po} =$	176.7 ksi	
layer 9	$f_{po} =$		177.3 ksi
layer 10	$f_{po} =$		177.3 ksi
layer 11	$f_{po} =$		177.3 ksi
layer 12	$f_{po} =$		177.3 ksi
layer 13	$f_{po} =$		177.3 ksi
layer 14	$f_{po} =$		177.3 ksi

strain in flexural tension

		at midspan	at endspan
layer 1	$\epsilon_x =$	0.002000	0.002000
layer 2	$\epsilon_x =$	0.002000	0.002000
layer 3	$\epsilon_x =$	0.002000	0.002000
layer 4	$\epsilon_x =$	0.002000	0.002000
layer 5	$\epsilon_x =$	0.002000	
layer 6	$\epsilon_x =$	0.002000	
layer 7	$\epsilon_x =$	0.002000	
layer 8	$\epsilon_x =$	0.002000	
layer 9	$\epsilon_x =$		0.002000
layer 10	$\epsilon_x =$		0.002000
layer 11	$\epsilon_x =$		0.002000
layer 12	$\epsilon_x =$		0.002000
layer 13	$\epsilon_x =$		0.002000
layer 14	$\epsilon_x =$		0.002000

### Deflection and Camber

Deflection due to Prestressing Force at Transfer  
 Deflection due to Beam Self-Weight at Transfer  
 Deflection due to Beam Self-Weight at Erection  
 Deflection due to Haunch and Deck

		at midspan	at endspan
	$\Delta_p =$	3.27 in	3.29 in
	$\Delta_g =$	-1.49 in	
	$\Delta_{gs} =$	-1.27 in	
	$\Delta_s =$	-1.95 in	

Deflection due to total self weight

$\Delta_{sw} =$	0.05 in
-----------------	---------

Total Deflection at transfer

$\Delta =$	1.79 in	1.81 in
------------	---------	---------

Total Deflection at erection

$\Delta =$	3.54 in	3.57 in
------------	---------	---------

Live load deflection limit = span/800

$=$	-1.80 in
-----	----------

Deflection due to live load and impact

$\Delta_L =$	-0.79 in
--------------	----------

OK

Deflection due to fire truck

$\Delta_L =$	-1.4447 in
--------------	------------

OK

Total Deflection after fire with fire truck

$\Delta =$	1.8832 in
------------	-----------

**Location: Fire at Critical Positive Moment Sections**  
**Beam Design: 3/8" Strand**  
**Fire Exposure Status: 1/2 Hour**

(PCI Bridge Design Manual Section 9.6)

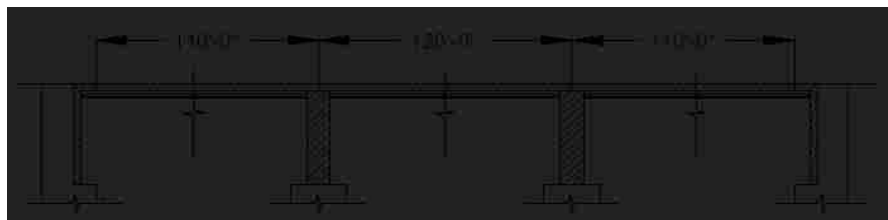


**Material Properties**

CAST-IN-PLACE SLAB			
Actual Thickness	$t_{as} =$		8.0 in
Wearing Surface	$=$		0.5 in
Structural thickness = Actual - Wearing Surface	$t_s =$		7.5 in
Compressive Strength	$f'_c =$		4 ksi
Unit Weight	$w_c =$		150.0 pcf
Stress factor of compression block	$\beta_1 =$		0.85

BEAMS: AASHTO-PCI, BT-72 BULB-TEE			
Strength at release	$f'_{ci} =$		5.5 ksi
Strength at 28 days	$f'_c =$		6.79 ksi
Unit Weight	$w_c =$		150.0 pcf
Overall Beam Length:			
@ end spans	$L =$		110 ft
@ center span	$L =$		119 ft
Design Spans:			
Non-composite beam @ end spans	$L =$		109 ft
Non-composite beam @ center span	$L =$		118 ft
Composite beam @ end spans	$L =$		110 ft
Composite beam @ center span	$L =$		120 ft
Beam Spacing	$S =$		12 ft





**PRESTRESSING STRANDS**

Diameter of single strand	d =	0.4 in
Area of single strand	A =	0.085 in <sup>2</sup>
Temperature of Layer		
	layer 1 (bottom)	T = 260.00 °F
	layer 2	T = 185.00 °F
	layer 3	T = 165.00 °F
	layer 4	T = 150.00 °F
	layer 5	T = 130.00 °F
	layer 6	T = 115.00 °F
	layer 7	T = 68.00 °F
	layer 8	T = 68.00 °F
	layer 9	T = 68.00 °F
	layer 10	T = 68.00 °F
	layer 11	T = 68.00 °F
	layer 12	T = 68.00 °F
	layer 13	T = 68.00 °F
	layer 14	T = 68.00 °F
Ultimate Strength		
initial = 284 ksi		
	layer 1 (bottom)	f <sub>pu</sub> = 284 ksi
	layer 2	f <sub>pu</sub> = 284 ksi
	layer 3	f <sub>pu</sub> = 284 ksi
	layer 4	f <sub>pu</sub> = 284 ksi
	layer 5	f <sub>pu</sub> = 284 ksi
	layer 6	f <sub>pu</sub> = 284 ksi
	layer 7	f <sub>pu</sub> = 284 ksi
	layer 8	f <sub>pu</sub> = 284 ksi
	layer 9	f <sub>pu</sub> = 284 ksi
	layer 10	f <sub>pu</sub> = 284 ksi
	layer 11	f <sub>pu</sub> = 284 ksi
	layer 12	f <sub>pu</sub> = 284 ksi
	layer 13	f <sub>pu</sub> = 284 ksi
	layer 14	f <sub>pu</sub> = 284 ksi
Yield Strength		
initial = 257 ksi		
	layer 1 (bottom)	f <sub>py</sub> = 252 ksi
	layer 2	f <sub>py</sub> = 254 ksi
	layer 3	f <sub>py</sub> = 254 ksi
	layer 4	f <sub>py</sub> = 254 ksi
	layer 5	f <sub>py</sub> = 254 ksi
	layer 6	f <sub>py</sub> = 257 ksi
	layer 7	f <sub>py</sub> = 257 ksi
	layer 8	f <sub>py</sub> = 257 ksi
	layer 9	f <sub>py</sub> = 257 ksi
	layer 10	f <sub>py</sub> = 257 ksi
	layer 11	f <sub>py</sub> = 257 ksi
	layer 12	f <sub>py</sub> = 257 ksi
	layer 13	f <sub>py</sub> = 257 ksi
	layer 14	f <sub>py</sub> = 257 ksi
<b>Stress Limits:</b>		
before transfer ≤ 0.75f <sub>pu</sub> (initial = 202.5)		
	layer 1 (bottom)	f <sub>pi</sub> = 213.2 ksi
	layer 2	f <sub>pi</sub> = 213.2 ksi
	layer 3	f <sub>pi</sub> = 213.2 ksi
	layer 4	f <sub>pi</sub> = 213.2 ksi
	layer 5	f <sub>pi</sub> = 213.2 ksi
	layer 6	f <sub>pi</sub> = 213.2 ksi
	layer 7	f <sub>pi</sub> = 213.2 ksi
	layer 8	f <sub>pi</sub> = 213.2 ksi
	layer 9	f <sub>pi</sub> = 213.2 ksi
	layer 10	f <sub>pi</sub> = 213.2 ksi
	layer 11	f <sub>pi</sub> = 213.2 ksi
	layer 12	f <sub>pi</sub> = 213.2 ksi
	layer 13	f <sub>pi</sub> = 213.2 ksi
	layer 14	f <sub>pi</sub> = 213.2 ksi



**COMPOSITE BEAM AT MIDSPAN**

Effective Flange Width	$b_f =$	111.0 in	*min of three criteria
Modular Ratio = $E_{cf}/E_c$	$n =$	0.7675	
Transformed flange width	$=$	85.2 in	
Transformed flange area	$=$	639.0 in <sup>2</sup>	
Transformed haunch width	$=$	32.2 in	
Transformed haunch area	$=$	16.1 in <sup>2</sup>	

	Transformed Area	$y_b$	$Ay_b$	$A(y_{bc}-y_b)^2$	$I$	$I + A(y_{bc}-y_b)^2$
Beam	767.0 in <sup>2</sup>	38.48 in	29,514.2 in <sup>3</sup>	230,977 in <sup>4</sup>	482,740 in <sup>4</sup>	713,717 in <sup>4</sup>
Haunch	16.1 in <sup>2</sup>	72.25 in	1,164.5 in <sup>3</sup>	4,344 in <sup>4</sup>	0.33 in <sup>4</sup>	4,344 in <sup>4</sup>
Deck	639.0 in <sup>2</sup>	76.25 in	48,721.3 in <sup>3</sup>	266,344 in <sup>4</sup>	2,950 in <sup>4</sup>	269,294 in <sup>4</sup>
Total	1422.1 in <sup>2</sup>		79,400.0 in <sup>3</sup>			987,355 in <sup>4</sup>

Total area of Composite Section	$A_c =$	1422 in <sup>2</sup>
Overall Depth of the Composite Section	$h_c =$	80 in
Moment of Inertia	$I_c =$	987,355 in <sup>4</sup>
Distance from centroid to extreme <u>bottom</u> fiber of beam	$y_{bc} =$	55.83 in
Distance from centroid to extreme <u>top</u> fiber of beam	$y_{tg} =$	16.17 in
Distance from centroid to extreme <u>top</u> fiber of slab	$y_{tc} =$	24.17 in
Section modulus for the extreme <u>bottom</u> fiber of beam	$S_{bc} =$	17,683.9 in <sup>3</sup>
Section modulus for the extreme <u>top</u> fiber of beam	$S_{tg} =$	61,074.0 in <sup>3</sup>
Section modulus for the extreme <u>top</u> fiber slab	$S_{tc} =$	53,230.9 in <sup>3</sup>

**Shear Forces and Bending Moments**

**DEAD LOADS**

Beam self-weight	$w_{beam} =$	0.799 k/f
8 in. deck weight	$w_{deck} =$	1.200 k/f
1/2 in. haunch weight	$w_{haunch} =$	0.022 k/f

LRFD Specifications: Art. 4.6.2.2.1		
Width of Deck Constant		OK
Number of beams is not less than four $N_b =$	4	OK
Roadway part of the overhang, $d_o \leq 3.0$ ft, $d_o =$	1.5	OK
Curvature in plans is less than $4^\circ =$	0	OK
Cross-section of the bridge is consistent with one of the cross sections given by LRFD specs		OK

Barrier and wearing surface loads are equally distributed among the 4 beams

Barrier Wt	$W_t =$	0.150 k/f
Dead load of future wearing surface	$DW =$	0.263 k/f

**LIVE LOADS**

Fire truck live load front load (Point A)	$P_{live} =$	48.0 kips
Fire truck live load back load (Point B)	$P_{live} =$	22.0 kips
distance between two loads		19.2 ft
distance from nearest edge to point A	$x_a =$	59.0 ft
distance from nearest edge to point B	$x_b =$	39.8 ft

LRFD Specifications: Art. 4.6.2.2.1		
Width of Deck Constant		OK
Number of beams is not less than four $N_b =$	4	OK
Beams are parallel and approximately of the same stiffness		OK
Roadway part of the overhang, $d_o \leq 3.0$ ft, $d_o =$	1.5	OK
Curvature in plans is less than $4^\circ =$	0	OK

Barrier and wearing surface loads are equally distributed among the 4 beams

Bridge Type-- "k" (LRFD Table 4.6.2.2.1-1)		
Number of design lanes = $w/12$	$=$	3 lanes

**Distribution Factor for Bending Moment:**

Beams spacing	S =	12.0 ft
Depth of concrete slab	t <sub>s</sub> =	7.5 in
Beam Span	L =	120.0 ft
Number of Beams	N <sub>b</sub> =	4
Modular ratio between beam & deck materials	n =	1.3029
Longitudinal stiffness parameter	K <sub>g</sub> =	2,199,990.66 in <sup>4</sup>

at center span:

$$DFM = 0.75 + \left(\frac{S}{9.5}\right)^{0.6} + \left(\frac{S}{L}\right)^{0.2} + \left(\frac{K_g}{12 * L * t_s^3}\right)^{0.1}$$

DFM =	0.901 lanes/beam
-------	------------------

one design lane loaded:

$$DFM = 0.75 + \left(\frac{S}{14}\right)^{0.4} + \left(\frac{S}{L}\right)^{0.3} + \left(\frac{K_g}{12 * L * t_s^3}\right)^{0.1}$$

DFM =	0.611 lanes/beam
-------	------------------

0.905 Controls

**Distribution Factor for Shear Force**

both end spans and center span:

$$DFV = 0.2 + \left(\frac{S}{12}\right) - \left(\frac{S}{35}\right)^2$$

DFV =	1.082 lanes/beam
-------	------------------

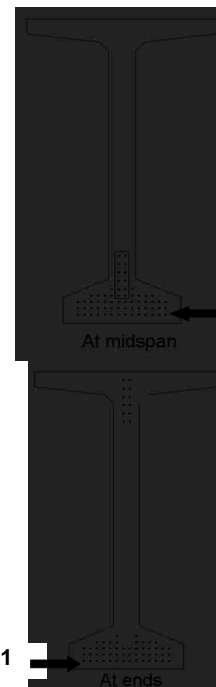
one design lane loaded:

$$DFV = 0.36 + \left(\frac{S}{25}\right)$$

DFV =	0.840 lanes/beam
-------	------------------

1.082 Controls

from bottom	At Midspan		At Ends	
	No. of	Distance from Bottom	No. of	Distance from Bottom
layer 1	14	2	14	2
layer 2	14	3.5	14	3.5
layer 3	14	5	14	5
layer 4	10	6.5	8	6.5
layer 5	4	8	2	8
layer 6	2	10	-	-
layer 7	2	12	-	-
layer 8	2	14	-	-
layer 9	2	16	2	60
layer 10	-	-	2	62
layer 11	-	-	2	64
layer 12	-	-	2	66
layer 13	-	-	2	68
layer 14	-	-	2	70
	64		64	
<b>Harped Strand Group (included in above totals)</b>				
layer 3	2	6		
layer 4	2	8		
layer 5	2	10		
layer 6	2	12		
layer 7	2	14		
layer 8	2	16		



distance from the center of gravity of strands to the bottom fiber of the beam = 7% of the beam depth  
strand eccentricity at midspan = (y<sub>b</sub> - y<sub>bs</sub>)

y <sub>bs</sub> =	5.44 in
e <sub>c</sub> =	33.04 in

layer 1

## Prestress Losses

### ELASTIC SHORTENING

assumed loss	=	6.00%
Force per strand at transfer		
layer 1	=	17.0 kips
layer 2	=	17.0 kips
layer 3	=	17.0 kips
layer 4	=	17.0 kips
layer 5	=	17.0 kips
layer 6	=	17.0 kips
layer 7	=	17.0 kips
layer 8	=	17.0 kips
layer 9	=	17.0 kips
layer 10	=	17.0 kips
layer 11	=	17.0 kips
layer 12	=	17.0 kips
layer 13	=	17.0 kips
layer 14	=	17.0 kips

Total prestressing force at release	$P_i =$	at midspan 1088.0 kips	at endspan 1054.0 kips
Sum of concrete stresses at the center of gravity of prestressing tendons due to prestressing force at transfer and the self-weight of the member at sections of maximum moment	$f_{cgp} =$	2.737 ksi	2.616 ksi
Loss due to shortening		at midspan	at endspan
layer 1	$\Delta f_{pES} =$	16.2 ksi	15.5 ksi
layer 2	$\Delta f_{pES} =$	16.1 ksi	15.4 ksi
layer 3	$\Delta f_{pES} =$	16.1 ksi	15.4 ksi
layer 4	$\Delta f_{pES} =$	15.9 ksi	15.2 ksi
layer 5	$\Delta f_{pES} =$	15.9 ksi	15.2 ksi
layer 6	$\Delta f_{pES} =$	15.9 ksi	
layer 7	$\Delta f_{pES} =$	15.8 ksi	
layer 8	$\Delta f_{pES} =$	15.8 ksi	
layer 9	$\Delta f_{pES} =$	15.8 ksi	15.1 ksi
layer 10	$\Delta f_{pES} =$		15.1 ksi
layer 11	$\Delta f_{pES} =$		15.1 ksi
layer 12	$\Delta f_{pES} =$		15.1 ksi
layer 13	$\Delta f_{pES} =$		15.1 ksi
layer 14	$\Delta f_{pES} =$		15.1 ksi

### SHRINKAGE

Shrinkage = (17-0.15*Relative Humidity)	$\Delta f_{pSR} =$	6.5 ksi	← assume relative humidity = 70%
---	--------------------	---------	----------------------------------

### CREEP OF CONCRETE

Change of stresses at center of gravity of prestressing due to permanent loads except the loads acting at time of applying prestressing force, calculated at the same section as $f_{cgp}$	$\Delta f_{cdp} =$	1.870 ksi	
loss due to creep	$\Delta f_{pCR} =$	at midspan 19.8 ksi	at endspan 18.3 ksi

**RELAXATION OF PRESTRESSING STRANDS**

loss due to relaxation after transfer		at midspan	at endspan
layer 1	$\Delta f_{pR2} =$	2.5 ksi	2.6 ksi
layer 2	$\Delta f_{pR2} =$	2.5 ksi	2.6 ksi
layer 3	$\Delta f_{pR2} =$	2.5 ksi	2.6 ksi
layer 4	$\Delta f_{pR2} =$	2.5 ksi	2.6 ksi
layer 5	$\Delta f_{pR2} =$	2.5 ksi	2.6 ksi
layer 6	$\Delta f_{pR2} =$	2.5 ksi	
layer 7	$\Delta f_{pR2} =$	2.5 ksi	
layer 8	$\Delta f_{pR2} =$	2.5 ksi	
layer 9	$\Delta f_{pR2} =$	2.5 ksi	2.6 ksi
layer 10	$\Delta f_{pR2} =$		2.6 ksi
layer 11	$\Delta f_{pR2} =$		2.6 ksi
layer 12	$\Delta f_{pR2} =$		2.6 ksi
layer 13	$\Delta f_{pR2} =$		2.6 ksi
layer 14	$\Delta f_{pR2} =$		2.6 ksi

**TOTAL LOSSES AT TRANSFER**

total loss  $\Delta f_{pES} = \Delta f_{pi}$

stress in tendons after transfer  $f_{pt} = f_{pi} - \Delta f_{pi}$

		at midspan	at endspan
layer 1	$f_{pt} =$	196.9 ksi	197.6 ksi
layer 2	$f_{pt} =$	197.1 ksi	197.8 ksi
layer 3	$f_{pt} =$	197.1 ksi	197.8 ksi
layer 4	$f_{pt} =$	197.2 ksi	197.9 ksi
layer 5	$f_{pt} =$	197.2 ksi	197.9 ksi
layer 6	$f_{pt} =$	197.2 ksi	
layer 7	$f_{pt} =$	197.4 ksi	
layer 8	$f_{pt} =$	197.4 ksi	
layer 9	$f_{pt} =$	197.4 ksi	198.1 ksi
layer 10	$f_{pt} =$		198.1 ksi
layer 11	$f_{pt} =$		198.1 ksi
layer 12	$f_{pt} =$		198.1 ksi
layer 13	$f_{pt} =$		198.1 ksi
layer 14	$f_{pt} =$		198.1 ksi

force per strand =  $f_{pt} \times$  strand area

		at midspan	at endspan
layer 1	=	16.7 kips	16.8 kips
layer 2	=	16.8 kips	16.8 kips
layer 3	=	16.8 kips	16.8 kips
layer 4	=	16.8 kips	16.8 kips
layer 5	=	16.8 kips	16.8 kips
layer 6	=	16.8 kips	
layer 7	=	16.8 kips	
layer 8	=	16.8 kips	
layer 9	=	16.8 kips	16.8 kips
layer 10	=		16.8 kips
layer 11	=		16.8 kips
layer 12	=		16.8 kips
layer 13	=		16.8 kips
layer 14	=		16.8 kips
Total prestressing force after transfer	$P_i =$	1040.2 kips	1041.6 kips

Initial loss =  $(\Delta f_{pi}) / (f_{pi})$

		at midspan	at endspan
layer 1	% =	7.6%	7.3%
layer 2	% =	7.5%	7.2%
layer 3	% =	7.5%	7.2%
layer 4	% =	7.5%	7.1%
layer 5	% =	7.5%	7.1%
layer 6	% =	7.5%	
layer 7	% =	7.4%	
layer 8	% =	7.4%	
layer 9	% =	7.4%	7.1%
layer 10	% =		7.1%
layer 11	% =		7.1%
layer 12	% =		7.1%
layer 13	% =		7.1%
layer 14	% =		7.1%

OK  
OK  
OK  
OK  
OK  
OK  
OK  
OK  
OK  
OK  
OK  
OK  
OK  
OK

**TOTAL LOSSES AT SERVICE LOADS**

Total Losses		at midspan	at endspan
layer 1	$\Delta f_{pT} =$	45.0 ksi	44.2 ksi
layer 2	$\Delta f_{pT} =$	44.8 ksi	44.1 ksi
layer 3	$\Delta f_{pT} =$	44.8 ksi	44.1 ksi
layer 4	$\Delta f_{pT} =$	44.7 ksi	43.9 ksi
layer 5	$\Delta f_{pT} =$	44.7 ksi	43.9 ksi
layer 6	$\Delta f_{pT} =$	44.7 ksi	
layer 7	$\Delta f_{pT} =$	44.5 ksi	
layer 8	$\Delta f_{pT} =$	44.5 ksi	
layer 9	$\Delta f_{pT} =$	44.5 ksi	43.8 ksi
layer 10	$\Delta f_{pT} =$		43.8 ksi
layer 11	$\Delta f_{pT} =$		43.8 ksi
layer 12	$\Delta f_{pT} =$		43.8 ksi
layer 13	$\Delta f_{pT} =$		43.8 ksi
layer 14	$\Delta f_{pT} =$		43.8 ksi

Stress in tendon after all losses =  $f_{pi} - \Delta f_{pt}$

		at midspan	at endspan
layer 1	$f_{pe} =$	168.2 ksi	168.9 ksi
layer 2	$f_{pe} =$	168.3 ksi	169.1 ksi
layer 3	$f_{pe} =$	168.3 ksi	169.1 ksi
layer 4	$f_{pe} =$	168.5 ksi	169.2 ksi
layer 5	$f_{pe} =$	168.5 ksi	169.2 ksi
layer 6	$f_{pe} =$	168.5 ksi	
layer 7	$f_{pe} =$	168.7 ksi	
layer 8	$f_{pe} =$	168.7 ksi	
layer 9	$f_{pe} =$	168.7 ksi	169.4 ksi
layer 10	$f_{pe} =$		169.4 ksi
layer 11	$f_{pe} =$		169.4 ksi
layer 12	$f_{pe} =$		169.4 ksi
layer 13	$f_{pe} =$		169.4 ksi
layer 14	$f_{pe} =$		169.4 ksi

check prestressing stress limit at service limit state:  $f_{pe} \leq 0.8 \cdot f_{py}$

layer 1	=	201.3 ksi
layer 2	=	203.4 ksi
layer 3	=	203.4 ksi
layer 4	=	203.4 ksi
layer 5	=	203.4 ksi
layer 6	=	205.4 ksi
layer 7	=	205.4 ksi
layer 8	=	205.4 ksi
layer 9	=	205.4 ksi
layer 10	=	205.4 ksi
layer 11	=	205.4 ksi
layer 12	=	205.4 ksi
layer 13	=	205.4 ksi
layer 14	=	205.4 ksi

OK  
OK  
OK  
OK  
OK  
OK  
OK  
OK  
OK  
OK  
OK  
OK  
OK  
OK

force per strand =  $f_{pe}$  \* strand area

		at midspan	at endspan
layer 1	=	14.3 kips	14.4 kips
layer 2	=	14.3 kips	14.4 kips
layer 3	=	14.3 kips	14.4 kips
layer 4	=	14.3 kips	14.4 kips
layer 5	=	14.3 kips	14.4 kips
layer 6	=	14.3 kips	
layer 7	=	14.3 kips	
layer 8	=	14.3 kips	
layer 9	=	14.3 kips	14.4 kips
layer 10	=		14.4 kips
layer 11	=		14.4 kips
layer 12	=		14.4 kips
layer 13	=		14.4 kips
layer 14	=		14.4 kips

		at midspan	at endspan
Total prestressing force after all losses	$P_{pe} =$	916.0 kips	919.9 kips

Final losses, % =  $(\Delta f_{PT}) / (f_{pi})$

layer 1	% =	21.1%	20.8%
layer 2	% =	21.0%	20.7%
layer 3	% =	21.0%	20.7%
layer 4	% =	20.9%	20.6%
layer 5	% =	20.9%	20.6%
layer 6	% =	20.9%	
layer 7	% =	20.9%	
layer 8	% =	20.9%	
layer 9	% =	20.9%	20.5%
layer 10	% =		20.5%
layer 11	% =		20.5%
layer 12	% =		20.5%
layer 13	% =		20.5%
layer 14	% =		20.5%
Average final losses, %	% =	21.0%	20.6%

### Stresses at Transfer

#### STRESS LIMITS FOR CONCRETE

Compression = $0.6f_{ci}$	$f_{ci} =$	3.300 ksi
Tension		
without bonded reinforcement = $-0.0948 \sqrt{f_{ci}} \leq -0.2$	$=$	-0.200 ksi
with bonded auxiliary reinforcement = $-0.22 \sqrt{f_{ci}}$	$=$	-0.016 ksi

#### STRESSES AT TRANSFER LENGTH SECTION

Transfer Length = $60 \times (\text{strand diameter})$	$=$	1.9 ft
Bending moment at transfer length	$M_g =$	87.7 ft-kips
center of 12 strands to top fiber of beam at the end	$=$	7.00 in
center of 12 strands to bottom fiber of beam at the harp point	$=$	11.00 in
center of 12 strands and top fiber of beam at transfer length	$=$	9.84 in
center of gravity of 32 strands and bottom fiber of beam	$=$	3.98 in
center of gravity of all strands and the bottom fiber of beam at transfer length	$=$	15.24 in
center of gravity of all strands and the bottom fiber of beam at the end	$=$	15.30 in
Eccentricity of the strand group at transfer length:	$e_h =$	23.24 in
Eccentricity at end of beam:	$e =$	23.18 in

Calcs for eccentricity (see 9.6.7.2)

$$f_t = \frac{P_i}{A} - \frac{P_i e}{S_t} + \frac{M_g}{S_t}$$

$$f_b = \frac{P_i}{A} + \frac{P_i e}{S_b} - \frac{M_g}{S_b}$$

		at midspan	at endspan
Top stress at top fiber of beam	$f_t =$	-0.143 ksi	-0.143 ksi
Bottom stress at bottom fiber of the beam	$f_b =$	3.043 ksi	3.043 ksi

OK  
OK



STRESSES AT HARP POINT			
Bending moment due to beam weight at 0.3L	$M_g =$	1188.0 ft-kips	
Top stress at top fiber of beam	$f_t =$	0.052 ksi	0.051 ksi
Bottom stress at bottom fiber of the beam	$f_b =$	2.873 ksi	2.710 ksi

OK  
OK

STRESSES AT MIDSPAN			
Bending moment due to beam weight at 0.5L	$M_g =$	1414.3 ft-kips	
Top stress at top fiber of beam	$f_t =$	0.188 ksi	0.227 ksi
Bottom stress at bottom fiber of the beam	$f_b =$	2.691 ksi	2.528 ksi

OK  
OK

#### HOLD-DOWN FORCES

assume stress in strand before losses =  $0.8f_u$

layer 1	=	227.4 ksi
layer 2	=	227.4 ksi
layer 3	=	227.4 ksi
layer 4	=	227.4 ksi
layer 5	=	227.4 ksi
layer 6	=	227.4 ksi
layer 7	=	227.4 ksi
layer 8	=	227.4 ksi
layer 9	=	227.4 ksi
layer 10	=	227.4 ksi
layer 11	=	227.4 ksi
layer 12	=	227.4 ksi
layer 13	=	227.4 ksi
layer 14	=	227.4 ksi

prestress force per strand before any losses:

layer 1	=	19.3 kips
layer 2	=	19.3 kips
layer 3	=	19.3 kips
layer 4	=	19.3 kips
layer 5	=	19.3 kips
layer 6	=	19.3 kips
layer 7	=	19.3 kips
layer 8	=	19.3 kips
layer 9	=	19.3 kips
layer 10	=	19.3 kips
layer 11	=	19.3 kips
layer 12	=	19.3 kips
layer 13	=	19.3 kips
layer 14	=	19.3 kips
Harp Angle	$\psi =$	7.2 °

Hold-down force/strand

layer 1	=	2.5 kips/strand
layer 2	=	2.5 kips/strand
layer 3	=	2.5 kips/strand
layer 4	=	2.5 kips/strand
layer 5	=	2.5 kips/strand
layer 6	=	2.5 kips/strand
layer 7	=	2.5 kips/strand
layer 8	=	2.5 kips/strand
layer 9	=	2.5 kips/strand
layer 10	=	2.5 kips/strand
layer 11	=	2.5 kips/strand
layer 12	=	2.5 kips/strand
layer 13	=	2.5 kips/strand
layer 14	=	2.5 kips/strand
Total hold-down force	=	30.45 kips

### Stresses at Service Loads

#### STRESS LIMITS FOR CONCRETE

##### Compression:

Due to permanent loads for load combination Service I

for the precast beam	=	3.056 ksi
for deck	=	1.800 ksi

Due to permanent and transient loads for load combination Service I

for the precast beam	=	4.074 ksi
for deck	=	2.400 ksi

##### Tension:

Load Combination Service III

for the precast beam	=	-0.016 ksi
----------------------	---	------------

#### STRESSES AT MIDSPAN

Compression stresses at top fiber of beam	at midspan	at endspan		
$f_i = \frac{P_{ps}}{A} - \frac{P_{ps}e}{S_i} + \frac{(M_D + M_{12})}{S_i} + \frac{(M_{ms} + M_s)}{S_{ps}}$				
Due to permanent loads	$f_{i0} =$	2.008 ksi	2.005 ksi	OK
$f_{is} = \frac{P_{ps}}{A} - \frac{P_{ps}e}{S_i} + \frac{(M_D + M_{12})}{S_i} + \frac{(M_{ms} + M_s)}{S_{ps}} + \frac{(M_{LL1})}{S_{ps}}$				
Due to permanent loads and transient loads	$f_{i0} =$	2.424 ksi	2.421 ksi	OK
Compression stresses at top fiber of deck	at midspan	at endspan		
$f_{tr} = \frac{(M_{ms} + M_s)}{S_{tr}}$				
Due to permanent loads	$f_{tr} =$	0.045 ksi	0.045 ksi	OK
$f_{tr} = \frac{(M_{ms} + M_s + M_{LL1})}{S_{tr}}$				
Due to permanent loads and transient loads	$f_{tr} =$	0.522 ksi	0.522 ksi	OK
Tension stresses at top fiber of deck	at midspan	at endspan		
$f_{tr} = \frac{P_{ps}}{A} + \frac{P_{ps}e}{S_i} - \frac{(M_D + M_{12})}{S_i} - \frac{(M_{ms} + M_s + 0.8 * M_{LL1})}{S_{tr}}$				
Load Combination Service III	$f_{t0} =$	-0.891 ksi	-0.877 ksi	OK

### Strength Limit State

#### POSITIVE MOMENT SECTION

$M_u = 1.25DC + 1.5DW + 1.75(LL+IM)$	$M_u =$	8381.5 ft-kips
--------------------------------------	---------	----------------

effective length factor for compression members

layer 1	k =	0.31
layer 2	k =	0.29
layer 3	k =	0.29
layer 4	k =	0.29
layer 5	k =	0.29
layer 6	k =	0.27
layer 7	k =	0.27
layer 8	k =	0.27
layer 9	k =	0.27
layer 10	k =	0.27
layer 11	k =	0.27
layer 12	k =	0.27
layer 13	k =	0.27
layer 14	k =	0.27
	c =	4.6 ft-kips

average stress in prestressing steel

layer 1	$f_{ps} =$	278.7 ksi
layer 2	$f_{ps} =$	278.7 ksi
layer 3	$f_{ps} =$	278.7 ksi
layer 4	$f_{ps} =$	278.7 ksi
layer 5	$f_{ps} =$	278.7 ksi
layer 6	$f_{ps} =$	278.7 ksi
layer 7	$f_{ps} =$	278.7 ksi
layer 8	$f_{ps} =$	278.7 ksi
layer 9	$f_{ps} =$	278.7 ksi
layer 10	$f_{ps} =$	278.7 ksi
layer 11	$f_{ps} =$	278.7 ksi
layer 12	$f_{ps} =$	278.7 ksi
layer 13	$f_{ps} =$	278.7 ksi
layer 14	$f_{ps} =$	278.7 ksi

nominal flexure resistance

	$a =$	3.94 in	
$M_r = \Phi M_n, \Phi = 1.00$	$\Phi M_n =$	9173.3 ft-kips	OK
$M = DC + W + LL + IM$	$M =$	5833.6 ft-kips	OK
<b>NEGATIVE MOMENT SECTION</b>			
$M_u = 1.25DC + 1.5DW + 1.75(LL + IM)$	$M_u =$	4837.2 ft-kips	
	$a =$	5.91 in	
	$\Phi M_n =$	4873.1 ft-kips	OK
$M = DC + W + LL + IM$	$M =$	2869.7 ft-kips	OK

### Shear Design

#### CRITICAL SECTION AT 0.59

$V_u = 1.25DC + 1.5DW + 1.75(LL + IM)$	$V_u =$	405.0 kips
$M_u = 1.25DC + 1.5DW + 1.75(LL + IM)$	$M_u =$	-2684.4 ft-kips
or		
$V_u = 1.25DC + 1.5DW + 1.75(LL + IM)$	$V_u =$	364.8 kips
$M_u = 1.25DC + 1.5DW + 1.75(LL + IM)$	$M_u =$	-2877.0 ft-kips
max shear	$V_u =$	405.0 kips
max moment	$M_u =$	2877.0 ft-kips
Shear depth	$d_v =$	73.19 in
Applied factored normal force at the section	$N_u =$	0
Angle of diagonal compressive stresses	$\theta =$	36.00 °

#### STRAIN IN FLEXURAL TENSION REINFORCEMENT

$\epsilon_s = \frac{\frac{M_u}{d_v} + (1.5N_u + 0.5W_u \cos \theta) - A_{ps} f_{ps}}{E_s A_s + E_p A_{ps}} \leq 0.002$		
	<b>at midspan</b>	<b>at endspan</b>
resultant compressive stress at centroid	$f_{pc} =$	0.811 ksi
effective stress in prestressing strand after all losses		0.813 ksi

layer 1	$f_{po} =$	172.5 ksi	173.2 ksi
layer 2	$f_{po} =$	172.6 ksi	173.4 ksi
layer 3	$f_{po} =$	172.6 ksi	173.4 ksi
layer 4	$f_{po} =$	172.7 ksi	173.5 ksi
layer 5	$f_{po} =$	172.7 ksi	
layer 6	$f_{po} =$	172.7 ksi	
layer 7	$f_{po} =$	172.9 ksi	
layer 8	$f_{po} =$	172.9 ksi	
layer 9	$f_{po} =$		173.6 ksi
layer 10	$f_{po} =$		173.6 ksi
layer 11	$f_{po} =$		173.6 ksi
layer 12	$f_{po} =$		173.6 ksi
layer 13	$f_{po} =$		173.6 ksi
layer 14	$f_{po} =$		173.6 ksi

strain in flexural tension

		at midspan	at endspan
layer 1	$\epsilon_x =$	0.002000	0.002000
layer 2	$\epsilon_x =$	0.002000	0.002000
layer 3	$\epsilon_x =$	0.002000	0.002000
layer 4	$\epsilon_x =$	0.002000	0.002000
layer 5	$\epsilon_x =$	0.002000	
layer 6	$\epsilon_x =$	0.002000	
layer 7	$\epsilon_x =$	0.002000	
layer 8	$\epsilon_x =$	0.002000	
layer 9	$\epsilon_x =$		0.002000
layer 10	$\epsilon_x =$		0.002000
layer 11	$\epsilon_x =$		0.002000
layer 12	$\epsilon_x =$		0.002000
layer 13	$\epsilon_x =$		0.002000
layer 14	$\epsilon_x =$		0.002000

### Deflection and Camber

Deflection due to Prestressing Force at Transfer  
 Deflection due to Beam Self-Weight at Transfer  
 Deflection due to Beam Self-Weight at Erection  
 Deflection due to Haunch and Deck

		at midspan	at endspan
$\Delta_p =$		3.27 in	3.29 in
$\Delta_g =$		-1.66 in	
$\Delta_g =$		-1.45 in	
$\Delta_s =$		-2.21 in	

Deflection due to total self weight

$\Delta_{sw} =$		-0.38 in	
-----------------	--	----------	--

Total Deflection at transfer

$\Delta =$		1.61 in	1.63 in
Total Deflection at erection		3.22 in	3.25 in

Live load deflection limit = span/800

$=$		-1.80 in	
-----	--	----------	--

Deflection due to live load and impact

$\Delta_L =$		-0.89 in	
--------------	--	----------	--

OK

Deflection due to fire truck

$\Delta_L =$		-1.6407 in	
--------------	--	------------	--

OK

Total Deflection after fire with fire truck

$\Delta =$		1.2505 in	
------------	--	-----------	--

**Location: Fire at Critical Positive Moment Sections**  
**Beam Design: 3/8" Strand**  
**Fire Exposure Status: 1 Hour**

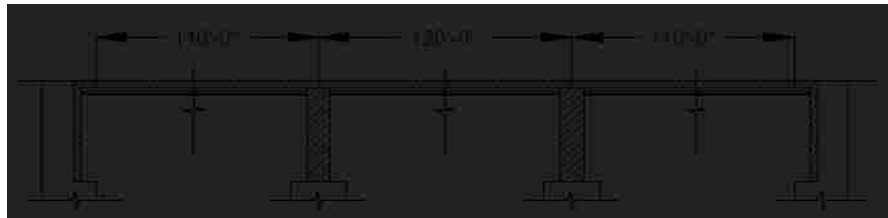
(PCI Bridge Design Manual Section 9.6)



**Material Properties**

CAST-IN-PLACE SLAB			
Actual Thickness	$t_{as} =$		8.0 in
Wearing Surface	$=$		0.5 in
Structural thickness = Actual - Wearing Surface	$t_s =$		7.5 in
Compressive Strength	$f'_c =$		4 ksi
Unit Weight	$w_c =$		150.0 pcf
Stress factor of compression block	$\beta_1 =$		0.85

BEAMS: AASHTO-PCI, BT-72 BULB-TEE			
Strength at release	$f'_{ci} =$		5.5 ksi
Strength at 28 days	$f'_c =$		6.57 ksi
Unit Weight	$w_c =$		150.0 pcf
Overall Beam Length:			
@ end spans	$L =$		110 ft
@ center span	$L =$		119 ft
Design Spans:			
Non-composite beam @ end spans	$L =$		109 ft
Non-composite beam @ center span	$L =$		118 ft
Composite beam @ end spans	$L =$		110 ft
Composite beam @ center span	$L =$		120 ft
Beam Spacing	$S =$		12 ft



**PRESTRESSING STRANDS**

Diameter of single strand	d =	0.4 in
Area of single strand	A =	0.085 in <sup>2</sup>
Temperature of Layer		
layer 1 (bottom)	T =	530.00 °F
layer 2	T =	360.00 °F
layer 3	T =	295.00 °F
layer 4	T =	275.00 °F
layer 5	T =	255.00 °F
layer 6	T =	230.00 °F
layer 7	T =	205.00 °F
layer 8	T =	190.00 °F
layer 9	T =	180.00 °F
layer 10	T =	68.00 °F
layer 11	T =	68.00 °F
layer 12	T =	68.00 °F
layer 13	T =	68.00 °F
layer 14	T =	68.00 °F
Ultimate Strength		
initial = 284 ksi		
layer 1 (bottom)	f <sub>pu</sub> =	279 ksi
layer 2	f <sub>pu</sub> =	284 ksi
layer 3	f <sub>pu</sub> =	284 ksi
layer 4	f <sub>pu</sub> =	284 ksi
layer 5	f <sub>pu</sub> =	284 ksi
layer 6	f <sub>pu</sub> =	284 ksi
layer 7	f <sub>pu</sub> =	284 ksi
layer 8	f <sub>pu</sub> =	284 ksi
layer 9	f <sub>pu</sub> =	284 ksi
layer 10	f <sub>pu</sub> =	284 ksi
layer 11	f <sub>pu</sub> =	284 ksi
layer 12	f <sub>pu</sub> =	284 ksi
layer 13	f <sub>pu</sub> =	284 ksi
layer 14	f <sub>pu</sub> =	284 ksi
Yield Strength		
initial = 257 ksi		
layer 1 (bottom)	f <sub>py</sub> =	236 ksi
layer 2	f <sub>py</sub> =	249 ksi
layer 3	f <sub>py</sub> =	249 ksi
layer 4	f <sub>py</sub> =	252 ksi
layer 5	f <sub>py</sub> =	252 ksi
layer 6	f <sub>py</sub> =	252 ksi
layer 7	f <sub>py</sub> =	254 ksi
layer 8	f <sub>py</sub> =	254 ksi
layer 9	f <sub>py</sub> =	254 ksi
layer 10	f <sub>py</sub> =	257 ksi
layer 11	f <sub>py</sub> =	257 ksi
layer 12	f <sub>py</sub> =	257 ksi
layer 13	f <sub>py</sub> =	257 ksi
layer 14	f <sub>py</sub> =	257 ksi
<b>Stress Limits:</b>		
before transfer ≤ 0.75f <sub>pu</sub> (initial = 202.5)		
layer 1 (bottom)	f <sub>pi</sub> =	208.9 ksi
layer 2	f <sub>pi</sub> =	213.2 ksi
layer 3	f <sub>pi</sub> =	213.2 ksi
layer 4	f <sub>pi</sub> =	213.2 ksi
layer 5	f <sub>pi</sub> =	213.2 ksi
layer 6	f <sub>pi</sub> =	213.2 ksi
layer 7	f <sub>pi</sub> =	213.2 ksi
layer 8	f <sub>pi</sub> =	213.2 ksi
layer 9	f <sub>pi</sub> =	213.2 ksi
layer 10	f <sub>pi</sub> =	213.2 ksi
layer 11	f <sub>pi</sub> =	213.2 ksi
layer 12	f <sub>pi</sub> =	213.2 ksi
layer 13	f <sub>pi</sub> =	213.2 ksi
layer 14	f <sub>pi</sub> =	213.2 ksi

at service limit state (after all losses)  $\leq 0.80f_{py}$  (initial = 194.4)

layer 1 (bottom)	$f_{pe} =$	189.0 ksi
layer 2	$f_{pe} =$	199.3 ksi
layer 3	$f_{pe} =$	199.3 ksi
layer 4	$f_{pe} =$	201.3 ksi
layer 5	$f_{pe} =$	201.3 ksi
layer 6	$f_{pe} =$	201.3 ksi
layer 7	$f_{pe} =$	203.4 ksi
layer 8	$f_{pe} =$	203.4 ksi
layer 9	$f_{pe} =$	203.4 ksi
layer 10	$f_{pe} =$	205.4 ksi
layer 11	$f_{pe} =$	205.4 ksi
layer 12	$f_{pe} =$	205.4 ksi
layer 13	$f_{pe} =$	205.4 ksi
layer 14	$f_{pe} =$	205.4 ksi

Modulus of Elasticity

initial = 25898 ksi

layer 1 (bottom)	$E =$	27969.8 ksi
layer 2	$E =$	27192.9 ksi
layer 3	$E =$	26933.9 ksi
layer 4	$E =$	26933.9 ksi
layer 5	$E =$	26674.9 ksi
layer 6	$E =$	26674.9 ksi
layer 7	$E =$	26416.0 ksi
layer 8	$E =$	26416.0 ksi
layer 9	$E =$	26416.0 ksi
layer 10	$E =$	25898.0 ksi
layer 11	$E =$	25898.0 ksi
layer 12	$E =$	25898.0 ksi
layer 13	$E =$	25898.0 ksi
layer 14	$E =$	25898.0 ksi

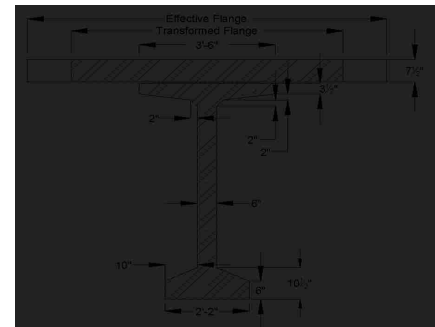
#### REINFORCING BARS

Yield Strength	$f_y =$	57.6 ksi
Modulus of Elasticity	$E =$	29000.0 ksi
Area of steel at endspan (effective flange)	$A_{se} =$	15.4 in <sup>2</sup>
Area of steel at midspan (effective flange)	$A_{sm} =$	0.0 in <sup>2</sup>
Area of temperature and shrinkage steel (12" width)	$A_s =$	0.0 in <sup>2</sup>

#### Cross-sectional Properties

##### NON-COMPOSITE BEAM

Area of cross-section of beam	$A =$	767.0 in <sup>2</sup>
Overall depth of beam	$H =$	72.0 in
Moment of Inertia	$I =$	440,915 in <sup>4</sup>
Distance from centroid to extreme <u>bottom</u> fiber	$y_b =$	40.3 in
Distance from centroid to extreme <u>top</u> fiber	$y_t =$	31.7 in
Section modulus for the extreme <u>bottom</u> fiber	$S_b =$	14915.0 in <sup>3</sup>
Section modulus for the extreme <u>top</u> fiber	$S_t =$	15421.0 in <sup>3</sup>
Weight	$W_t =$	799.0 plf
Modulus of Elasticity = $33000 \cdot (W_c^{1.5}) \cdot (\sqrt{f'_c})$		
cast-in-place concrete deck	$E_{cs} =$	3834 ksi
precast beam at release	$E_{ci} =$	4496 ksi
precast beam at service loads	$E_c =$	4914 ksi



**COMPOSITE BEAM AT MIDSPAN**

Effective Flange Width	$b_f =$	111.0 in	*min of three criteria
Modular Ratio = $E_{cf}/E_c$	$n =$	0.7803	
Transformed flange width	$=$	86.6 in	
Transformed flange area	$=$	649.6 in <sup>2</sup>	
Transformed haunch width	$=$	32.8 in	
Transformed haunch area	$=$	16.4 in <sup>2</sup>	

	Transformed Area	$y_b$	$Ay_b$	$A(y_{bc}-y_b)^2$	$I$	$I + A(y_{bc}-y_b)^2$
Beam	767.0 in <sup>2</sup>	40.31 in	30,917.8 in <sup>3</sup>	212,814 in <sup>4</sup>	440,915 in <sup>4</sup>	653,729 in <sup>4</sup>
Haunch	16.4 in <sup>2</sup>	72.25 in	1,183.9 in <sup>3</sup>	3,827 in <sup>4</sup>	0.33 in <sup>4</sup>	3,827 in <sup>4</sup>
Deck	649.6 in <sup>2</sup>	76.25 in	49,530.4 in <sup>3</sup>	241,530 in <sup>4</sup>	2,950 in <sup>4</sup>	244,479 in <sup>4</sup>
Total	1433.0 in <sup>2</sup>		81,632.0 in <sup>3</sup>			902,036 in <sup>4</sup>

Total area of Composite Section	$A_c =$	1433 in <sup>2</sup>
Overall Depth of the Composite Section	$h_c =$	80 in
Moment of Inertia	$I_c =$	902,036 in <sup>4</sup>
Distance from centroid to extreme <u>bottom</u> fiber of beam	$y_{bc} =$	56.97 in
Distance from centroid to extreme <u>top</u> fiber of beam	$y_{tg} =$	15.03 in
Distance from centroid to extreme <u>top</u> fiber of slab	$y_{tc} =$	23.03 in
Section modulus for the extreme <u>bottom</u> fiber of beam	$S_{bc} =$	15,834.3 in <sup>3</sup>
Section modulus for the extreme <u>top</u> fiber of beam	$S_{tg} =$	60,004.6 in <sup>3</sup>
Section modulus for the extreme <u>top</u> fiber slab	$S_{tc} =$	50,191.5 in <sup>3</sup>

**Shear Forces and Bending Moments**

**DEAD LOADS**

Beam self-weight	$w_{beam} =$	0.799 k/f
8 in. deck weight	$w_{deck} =$	1.200 k/f
1/2 in. haunch weight	$w_{haunch} =$	0.022 k/f

LRFD Specifications: Art. 4.6.2.2.1		
Width of Deck Constant		OK
Number of beams is not less than four $N_b =$	4	OK
Roadway part of the overhang, $d_o \leq 3.0$ ft, $d_o =$	1.5	OK
Curvature in plans is less than $4^\circ =$	0	OK
Cross-section of the bridge is consistent with one of the cross sections given by LRFD specs		OK

Barrier and wearing surface loads are equally distributed among the 4 beams

Barrier Wt	$W_t =$	0.150 k/f
Dead load of future wearing surface	$DW =$	0.263 k/f

**LIVE LOADS**

Fire truck live load front load (Point A)	$P_{live} =$	48.0 kips
Fire truck live load back load (Point B)	$P_{live} =$	22.0 kips
distance between two loads		19.2 ft
distance from nearest edge to point A	$x_a =$	59.0 ft
distance from nearest edge to point B	$x_b =$	39.8 ft

LRFD Specifications: Art. 4.6.2.2.1		
Width of Deck Constant		OK
Number of beams is not less than four $N_b =$	4	OK
Beams are parallel and approximately of the same stiffness		OK
Roadway part of the overhang, $d_o \leq 3.0$ ft, $d_o =$	1.5	OK
Curvature in plans is less than $4^\circ =$	0	OK

Barrier and wearing surface loads are equally distributed among the 4 beams

Bridge Type-- "k" (LRFD Table 4.6.2.2.1-1)		
Number of design lanes = $w/12$	$=$	3 lanes



**Distribution Factor for Bending Moment:**

Beams spacing	S =	12.0 ft
Depth of concrete slab	t <sub>s</sub> =	7.5 in
Beam Span	L =	120.0 ft
Number of Beams	N <sub>b</sub> =	4
Modular ratio between beam & deck materials	n =	1.2816
Longitudinal stiffness parameter	K <sub>g</sub> =	2,110,453.24 in <sup>4</sup>

at center span:

$$DFM = 0.75 + \left(\frac{S}{9.5}\right)^{0.6} + \left(\frac{S}{L}\right)^{0.2} + \left(\frac{K_g}{12 * L * t_s^3}\right)^{0.1}$$

DFM =	0.897 lanes/beam
-------	------------------

one design lane loaded:

$$DFM = 0.75 + \left(\frac{S}{14}\right)^{0.4} + \left(\frac{S}{L}\right)^{0.3} + \left(\frac{K_g}{12 * L * t_s^3}\right)^{0.1}$$

DFM =	0.609 lanes/beam
-------	------------------

0.905 Controls

**Distribution Factor for Shear Force**

both end spans and center span:

$$DFV = 0.2 + \left(\frac{S}{12}\right) - \left(\frac{S}{35}\right)^2$$

DFV =	1.082 lanes/beam
-------	------------------

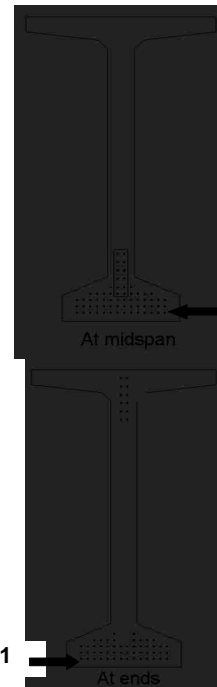
one design lane loaded:

$$DFV = 0.36 + \left(\frac{S}{25}\right)$$

DFV =	0.840 lanes/beam
-------	------------------

1.082 Controls

from bottom	At Midspan		At Ends	
	No. of	Distance from Bottom	No. of	Distance from Bottom
layer 1	14	2	14	2
layer 2	14	3.5	14	3.5
layer 3	14	5	14	5
layer 4	10	6.5	8	6.5
layer 5	4	8	2	8
layer 6	2	10	-	-
layer 7	2	12	-	-
layer 8	2	14	-	-
layer 9	2	16	2	60
layer 10	-	-	2	62
layer 11	-	-	2	64
layer 12	-	-	2	66
layer 13	-	-	2	68
layer 14	-	-	2	70
	64		64	
<b>Harped Strand Group (included in above totals)</b>				
layer 3	2	6		
layer 4	2	8		
layer 5	2	10		
layer 6	2	12		
layer 7	2	14		
layer 8	2	16		



distance from the center of gravity of strands to the bottom fiber of the beam = 7% of the beam depth  
strand eccentricity at midspan = (y<sub>b</sub> - y<sub>bs</sub>)

y <sub>bs</sub> =	5.44 in
e <sub>c</sub> =	34.87 in

layer 1

## Prestress Losses

### ELASTIC SHORTENING

assumed loss	=	6.00%
Force per strand at transfer		
layer 1	=	16.7 kips
layer 2	=	17.0 kips
layer 3	=	17.0 kips
layer 4	=	17.0 kips
layer 5	=	17.0 kips
layer 6	=	17.0 kips
layer 7	=	17.0 kips
layer 8	=	17.0 kips
layer 9	=	17.0 kips
layer 10	=	17.0 kips
layer 11	=	17.0 kips
layer 12	=	17.0 kips
layer 13	=	17.0 kips
layer 14	=	17.0 kips

		at midspan	at endspan
Total prestressing force at release	$P_i =$	1083.8 kips	1049.8 kips
Sum of concrete stresses at the center of gravity of prestressing tendons due to prestressing force at transfer and the self-weight of the member at sections of maximum moment	$f_{cgp} =$	3.082 ksi	2.944 ksi
Loss due to shortening		at midspan	at endspan
layer 1	$\Delta f_{pES} =$	19.2 ksi	18.3 ksi
layer 2	$\Delta f_{pES} =$	18.6 ksi	17.8 ksi
layer 3	$\Delta f_{pES} =$	18.5 ksi	17.6 ksi
layer 4	$\Delta f_{pES} =$	18.5 ksi	17.6 ksi
layer 5	$\Delta f_{pES} =$	18.3 ksi	17.5 ksi
layer 6	$\Delta f_{pES} =$	18.3 ksi	
layer 7	$\Delta f_{pES} =$	18.1 ksi	
layer 8	$\Delta f_{pES} =$	18.1 ksi	
layer 9	$\Delta f_{pES} =$	18.1 ksi	17.3 ksi
layer 10	$\Delta f_{pES} =$		17.0 ksi
layer 11	$\Delta f_{pES} =$		17.0 ksi
layer 12	$\Delta f_{pES} =$		17.0 ksi
layer 13	$\Delta f_{pES} =$		17.0 ksi
layer 14	$\Delta f_{pES} =$		17.0 ksi

### SHRINKAGE

Shrinkage = (17-0.15*Relative Humidity)	$\Delta f_{pSR} =$	6.5 ksi	← assume relative humidity = 70%
---	--------------------	---------	----------------------------------

### CREEP OF CONCRETE

Change of stresses at center of gravity of prestressing due to permanent loads except the loads acting at time of applying prestressing force, calculated at the same section as $f_{cgp}$	$\Delta f_{cdp} =$	2.156 ksi	
loss due to creep		at midspan	at endspan
	$\Delta f_{pCR} =$	21.9 ksi	20.2 ksi

**RELAXATION OF PRESTRESSING STRANDS**

loss due to relaxation after transfer		at midspan	at endspan
layer 1	$\Delta f_{pR2} =$	2.0 ksi	2.1 ksi
layer 2	$\Delta f_{pR2} =$	2.1 ksi	2.2 ksi
layer 3	$\Delta f_{pR2} =$	2.1 ksi	2.2 ksi
layer 4	$\Delta f_{pR2} =$	2.1 ksi	2.2 ksi
layer 5	$\Delta f_{pR2} =$	2.1 ksi	2.2 ksi
layer 6	$\Delta f_{pR2} =$	2.1 ksi	
layer 7	$\Delta f_{pR2} =$	2.1 ksi	
layer 8	$\Delta f_{pR2} =$	2.1 ksi	
layer 9	$\Delta f_{pR2} =$	2.1 ksi	2.2 ksi
layer 10	$\Delta f_{pR2} =$		2.3 ksi
layer 11	$\Delta f_{pR2} =$		2.3 ksi
layer 12	$\Delta f_{pR2} =$		2.3 ksi
layer 13	$\Delta f_{pR2} =$		2.3 ksi
layer 14	$\Delta f_{pR2} =$		2.3 ksi

**TOTAL LOSSES AT TRANSFER**

total loss  $\Delta f_{pES} = \Delta f_{pi}$

stress in tendons after transfer  $f_{pt} = f_{pi} - \Delta f_{pi}$

		at midspan	at endspan
layer 1	$f_{pt} =$	189.7 ksi	190.6 ksi
layer 2	$f_{pt} =$	194.5 ksi	195.3 ksi
layer 3	$f_{pt} =$	194.7 ksi	195.5 ksi
layer 4	$f_{pt} =$	194.7 ksi	195.5 ksi
layer 5	$f_{pt} =$	194.9 ksi	195.7 ksi
layer 6	$f_{pt} =$	194.9 ksi	
layer 7	$f_{pt} =$	195.0 ksi	
layer 8	$f_{pt} =$	195.0 ksi	
layer 9	$f_{pt} =$	195.0 ksi	195.9 ksi
layer 10	$f_{pt} =$		196.2 ksi
layer 11	$f_{pt} =$		196.2 ksi
layer 12	$f_{pt} =$		196.2 ksi
layer 13	$f_{pt} =$		196.2 ksi
layer 14	$f_{pt} =$		196.2 ksi

force per strand =  $f_{pt} \times$  strand area

		at midspan	at endspan
layer 1	=	16.1 kips	16.2 kips
layer 2	=	16.5 kips	16.6 kips
layer 3	=	16.5 kips	16.6 kips
layer 4	=	16.5 kips	16.6 kips
layer 5	=	16.6 kips	16.6 kips
layer 6	=	16.6 kips	
layer 7	=	16.6 kips	
layer 8	=	16.6 kips	
layer 9	=	16.6 kips	16.6 kips
layer 10	=		16.7 kips
layer 11	=		16.7 kips
layer 12	=		16.7 kips
layer 13	=		16.7 kips
layer 14	=		16.7 kips
Total prestressing force after transfer	$P_i =$	1018.4 kips	1024.6 kips

Initial loss =  $(\Delta f_{pi}) / (f_{pi})$

		at midspan	at endspan
layer 1	% =	9.2%	8.8%
layer 2	% =	8.7%	8.4%
layer 3	% =	8.7%	8.3%
layer 4	% =	8.7%	8.3%
layer 5	% =	8.6%	8.2%
layer 6	% =	8.6%	
layer 7	% =	8.5%	
layer 8	% =	8.5%	
layer 9	% =	8.5%	8.1%
layer 10	% =		8.0%
layer 11	% =		8.0%
layer 12	% =		8.0%
layer 13	% =		8.0%
layer 14	% =		8.0%

OK  
OK  
OK  
OK  
OK  
OK  
OK  
OK  
OK  
OK  
OK  
OK  
OK  
OK

**TOTAL LOSSES AT SERVICE LOADS**

Total Losses		at midspan	at endspan
layer 1	$\Delta f_{pT} =$	49.6 ksi	48.7 ksi
layer 2	$\Delta f_{pT} =$	49.0 ksi	48.2 ksi
layer 3	$\Delta f_{pT} =$	48.9 ksi	48.0 ksi
layer 4	$\Delta f_{pT} =$	48.9 ksi	48.0 ksi
layer 5	$\Delta f_{pT} =$	48.7 ksi	47.9 ksi
layer 6	$\Delta f_{pT} =$	48.7 ksi	
layer 7	$\Delta f_{pT} =$	48.5 ksi	
layer 8	$\Delta f_{pT} =$	48.5 ksi	
layer 9	$\Delta f_{pT} =$	48.5 ksi	47.7 ksi
layer 10	$\Delta f_{pT} =$		47.3 ksi
layer 11	$\Delta f_{pT} =$		47.3 ksi
layer 12	$\Delta f_{pT} =$		47.3 ksi
layer 13	$\Delta f_{pT} =$		47.3 ksi
layer 14	$\Delta f_{pT} =$		47.3 ksi

Stress in tendon after all losses =  $f_{pt} - \Delta f_{pt}$

		at midspan	at endspan
layer 1	$f_{pe} =$	159.3 ksi	160.2 ksi
layer 2	$f_{pe} =$	164.1 ksi	165.0 ksi
layer 3	$f_{pe} =$	164.3 ksi	165.1 ksi
layer 4	$f_{pe} =$	164.3 ksi	165.1 ksi
layer 5	$f_{pe} =$	164.5 ksi	165.3 ksi
layer 6	$f_{pe} =$	164.5 ksi	
layer 7	$f_{pe} =$	164.7 ksi	
layer 8	$f_{pe} =$	164.7 ksi	
layer 9	$f_{pe} =$	164.7 ksi	165.5 ksi
layer 10	$f_{pe} =$		165.8 ksi
layer 11	$f_{pe} =$		165.8 ksi
layer 12	$f_{pe} =$		165.8 ksi
layer 13	$f_{pe} =$		165.8 ksi
layer 14	$f_{pe} =$		165.8 ksi

check prestressing stress limit at service limit state:  $f_{pe} \leq 0.8 \cdot f_{py}$

layer 1	=	189.0 ksi
layer 2	=	199.3 ksi
layer 3	=	199.3 ksi
layer 4	=	201.3 ksi
layer 5	=	201.3 ksi
layer 6	=	201.3 ksi
layer 7	=	203.4 ksi
layer 8	=	203.4 ksi
layer 9	=	203.4 ksi
layer 10	=	205.4 ksi
layer 11	=	205.4 ksi
layer 12	=	205.4 ksi
layer 13	=	205.4 ksi
layer 14	=	205.4 ksi

OK  
OK  
OK  
OK  
OK  
OK  
OK  
OK  
OK  
OK  
OK  
OK  
OK  
OK

force per strand =  $f_{pe}$  \* strand area

		at midspan	at endspan
layer 1	=	13.5 kips	13.6 kips
layer 2	=	14.0 kips	14.0 kips
layer 3	=	14.0 kips	14.0 kips
layer 4	=	14.0 kips	14.0 kips
layer 5	=	14.0 kips	14.0 kips
layer 6	=	14.0 kips	
layer 7	=	14.0 kips	
layer 8	=	14.0 kips	
layer 9	=	14.0 kips	14.1 kips
layer 10	=		14.1 kips
layer 11	=		14.1 kips
layer 12	=		14.1 kips
layer 13	=		14.1 kips
layer 14	=		14.1 kips

Total prestressing force after all losses  $P_{pe} =$   
 Final losses, % =  $(\Delta f_{PT}) / (f_{pi})$

		at midspan	at endspan
$P_{pe} =$		887.9 kips	892.9 kips
layer 1	% =	23.7%	23.3%
layer 2	% =	23.5%	23.1%
layer 3	% =	23.4%	23.0%
layer 4	% =	23.4%	23.0%
layer 5	% =	23.3%	22.9%
layer 6	% =	23.3%	
layer 7	% =	23.2%	
layer 8	% =	23.2%	
layer 9	% =	23.2%	22.8%
layer 10	% =		22.7%
layer 11	% =		22.7%
layer 12	% =		22.7%
layer 13	% =		22.7%
layer 14	% =		22.7%
Average final losses, %	% =	23.4%	22.9%

### Stresses at Transfer

#### STRESS LIMITS FOR CONCRETE

Compression = $0.6f_{ci}$	$f_{ci} =$	3.300 ksi
Tension		
without bonded reinforcement = $-0.0948 \sqrt{f_{ci}} \leq -0.2$	$=$	-0.200 ksi
with bonded auxiliary reinforcement = $-0.22 \sqrt{f_{ci}}$	$=$	-0.016 ksi

#### STRESSES AT TRANSFER LENGTH SECTION

Transfer Length = $60 \times (\text{strand diameter})$	$=$	1.9 ft
Bending moment at transfer length	$M_g =$	87.7 ft-kips
center of 12 strands to top fiber of beam at the end	$=$	7.00 in
center of 12 strands to bottom fiber of beam at the harp point	$=$	11.00 in
center of 12 strands and top fiber of beam at transfer length	$=$	9.84 in
center of gravity of 32 strands and bottom fiber of beam	$=$	3.98 in
center of gravity of all strands and the bottom fiber of beam at transfer length	$=$	15.24 in
center of gravity of all strands and the bottom fiber of beam at the end	$=$	15.30 in
Eccentricity of the strand group at transfer length:	$e_h =$	25.07 in
Eccentricity at end of beam:	$e =$	25.01 in

Calcs for eccentricity (see 9.6.7.2)

$$f_t = \frac{P_1}{A} - \frac{P_1 e}{S_t} + \frac{M_g}{S_t}$$

$$f_b = \frac{P_1}{A} + \frac{P_1 e}{S_b} - \frac{M_g}{S_b}$$

		at midspan	at endspan
Top stress at top fiber of beam	$f_t =$	-0.259 ksi	-0.261 ksi
Bottom stress at bottom fiber of the beam	$f_b =$	3.164 ksi	3.164 ksi

OK  
OK

STRESSES AT HARP POINT			
Bending moment due to beam weight at 0.3L	$M_g =$	1188.0 ft-kips	
Top stress at top fiber of beam	$f_t =$	-0.051 ksi	-0.057 ksi
Bottom stress at bottom fiber of the beam	$f_b =$	2.991 ksi	2.776 ksi

OK  
OK

STRESSES AT MIDSPAN			
Bending moment due to beam weight at 0.5L	$M_g =$	1414.3 ft-kips	
Top stress at top fiber of beam	$f_t =$	0.063 ksi	0.119 ksi
Bottom stress at bottom fiber of the beam	$f_b =$	2.809 ksi	2.594 ksi

OK  
OK

#### HOLD-DOWN FORCES

assume stress in strand before losses =  $0.8f_u$

layer 1	=	222.8 ksi
layer 2	=	227.4 ksi
layer 3	=	227.4 ksi
layer 4	=	227.4 ksi
layer 5	=	227.4 ksi
layer 6	=	227.4 ksi
layer 7	=	227.4 ksi
layer 8	=	227.4 ksi
layer 9	=	227.4 ksi
layer 10	=	227.4 ksi
layer 11	=	227.4 ksi
layer 12	=	227.4 ksi
layer 13	=	227.4 ksi
layer 14	=	227.4 ksi

prestress force per strand before any losses:

layer 1	=	18.9 kips
layer 2	=	19.3 kips
layer 3	=	19.3 kips
layer 4	=	19.3 kips
layer 5	=	19.3 kips
layer 6	=	19.3 kips
layer 7	=	19.3 kips
layer 8	=	19.3 kips
layer 9	=	19.3 kips
layer 10	=	19.3 kips
layer 11	=	19.3 kips
layer 12	=	19.3 kips
layer 13	=	19.3 kips
layer 14	=	19.3 kips
Harp Angle	$\psi =$	7.2 °

Hold-down force/strand

layer 1	=	2.5 kips/strand
layer 2	=	2.5 kips/strand
layer 3	=	2.5 kips/strand
layer 4	=	2.5 kips/strand
layer 5	=	2.5 kips/strand
layer 6	=	2.5 kips/strand
layer 7	=	2.5 kips/strand
layer 8	=	2.5 kips/strand
layer 9	=	2.5 kips/strand
layer 10	=	2.5 kips/strand
layer 11	=	2.5 kips/strand
layer 12	=	2.5 kips/strand
layer 13	=	2.5 kips/strand
layer 14	=	2.5 kips/strand
Total hold-down force	=	30.45 kips

### Stresses at Service Loads

#### STRESS LIMITS FOR CONCRETE

##### Compression:

Due to permanent loads for load combination Service I

for the precast beam	=	2.957 ksi
for deck	=	1.800 ksi

Due to permanent and transient loads for load combination Service I

for the precast beam	=	3.942 ksi
for deck	=	2.400 ksi

##### Tension:

Load Combination Service III

for the precast beam	=	-0.015 ksi
----------------------	---	------------

#### STRESSES AT MIDSPAN

Compression stresses at top fiber of beam	at midspan	at endspan		
$f_i = \frac{P_{ps}}{A} - \frac{P_{ps}e}{S_i} + \frac{(M_D + M_L)}{S_i} + \frac{(M_{ps} + M_D)}{S_{ps}}$				
Due to permanent loads	$f_{i0} =$	1.927 ksi	1.922 ksi	OK
$f_{is} = \frac{P_{ps}}{A} - \frac{P_{ps}e}{S_i} + \frac{(M_D + M_L)}{S_i} + \frac{(M_{ps} + M_D)}{S_{ps}} + \frac{(M_{LL1})}{S_{ps}}$				
Due to permanent loads and transient loads	$f_{i0} =$	2.350 ksi	2.345 ksi	OK
Compression stresses at top fiber of deck	at midspan	at endspan		
$f_{tr} = \frac{(M_{ps} + M_D)}{S_{tr}}$				
Due to permanent loads	$f_{tr} =$	0.048 ksi	0.048 ksi	OK
$f_{tr} = \frac{(M_{ps} + M_D + M_{LL1})}{S_{tr}}$				
Due to permanent loads and transient loads	$f_{tr} =$	0.554 ksi	0.554 ksi	OK
Tension stresses at top fiber of deck	at midspan	at endspan		
$f_{tr} = \frac{P_{ps}}{A} + \frac{P_{ps}e}{S_i} - \frac{(M_D + M_L)}{S_i} - \frac{(M_{ps} + M_D + 0.8 * M_{LL1})}{S_{tr}}$				
Load Combination Service III	$f_{t0} =$	-1.031 ksi	-1.013 ksi	OK

### Strength Limit State

#### POSITIVE MOMENT SECTION

$M_u = 1.25DC + 1.5DW + 1.75(LL + IM)$	$M_u =$	8381.5 ft-kips
--	---------	----------------

effective length factor for compression members

layer 1	k =	0.38
layer 2	k =	0.33
layer 3	k =	0.33
layer 4	k =	0.31
layer 5	k =	0.31
layer 6	k =	0.31
layer 7	k =	0.29
layer 8	k =	0.29
layer 9	k =	0.29
layer 10	k =	0.27
layer 11	k =	0.27
layer 12	k =	0.27
layer 13	k =	0.27
layer 14	k =	0.27
	c =	4.6 ft-kips

average stress in prestressing steel

layer 1	$f_{ps} =$	271.9 ksi
layer 2	$f_{ps} =$	277.5 ksi
layer 3	$f_{ps} =$	277.5 ksi
layer 4	$f_{ps} =$	277.5 ksi
layer 5	$f_{ps} =$	277.5 ksi
layer 6	$f_{ps} =$	277.5 ksi
layer 7	$f_{ps} =$	277.5 ksi
layer 8	$f_{ps} =$	277.5 ksi
layer 9	$f_{ps} =$	277.5 ksi
layer 10	$f_{ps} =$	277.5 ksi
layer 11	$f_{ps} =$	277.5 ksi
layer 12	$f_{ps} =$	277.5 ksi
layer 13	$f_{ps} =$	277.5 ksi
layer 14	$f_{ps} =$	277.5 ksi

nominal flexure resistance

	$a =$	3.91 in	
$M_r = \Phi M_n, \Phi = 1.00$	$\Phi M_n =$	9091.4 ft-kips	OK
$M = DC + W + LL + IM$	$M =$	5833.6 ft-kips	OK
<b>NEGATIVE MOMENT SECTION</b>			
$M_u = 1.25DC + 1.5DW + 1.75(LL + IM)$	$M_u =$	4837.2 ft-kips	
	$a =$	6.11 in	
	$\Phi M_n =$	4866.5 ft-kips	OK
$M = DC + W + LL + IM$	$M =$	2869.7 ft-kips	OK

### Shear Design

#### CRITICAL SECTION AT 0.59

$V_u = 1.25DC + 1.5DW + 1.75(LL + IM)$	$V_u =$	405.0 kips
$M_u = 1.25DC + 1.5DW + 1.75(LL + IM)$	$M_u =$	-2684.4 ft-kips
or		
$V_u = 1.25DC + 1.5DW + 1.75(LL + IM)$	$V_u =$	364.8 kips
$M_u = 1.25DC + 1.5DW + 1.75(LL + IM)$	$M_u =$	-2877.0 ft-kips
max shear	$V_u =$	405.0 kips
max moment	$M_u =$	2877.0 ft-kips
Shear depth	$d_v =$	73.19 in
Applied factored normal force at the section	$N_u =$	0
Angle of diagonal compressive stresses	$\theta =$	36.00 °

#### STRAIN IN FLEXURAL TENSION REINFORCEMENT

$\epsilon_s = \frac{\frac{M_u}{d_v} + (1.5N_u + 0.5W_u \cos \theta) - A_{ps} f_{ps}}{E_s A_s + E_p A_{ps}} \leq 0.002$		
	at midspan	at endspan
resultant compressive stress at centroid	$f_{pc} =$	0.716 ksi
effective stress in prestressing strand after all losses		0.718 ksi

layer 1	$f_{po} =$	163.4 ksi	164.3 ksi
layer 2	$f_{po} =$	168.1 ksi	168.9 ksi
layer 3	$f_{po} =$	168.2 ksi	169.1 ksi
layer 4	$f_{po} =$	168.2 ksi	169.1 ksi
layer 5	$f_{po} =$	168.4 ksi	
layer 6	$f_{po} =$	168.4 ksi	
layer 7	$f_{po} =$	168.5 ksi	
layer 8	$f_{po} =$	168.5 ksi	
layer 9	$f_{po} =$		169.3 ksi
layer 10	$f_{po} =$		169.6 ksi
layer 11	$f_{po} =$		169.6 ksi
layer 12	$f_{po} =$		169.6 ksi
layer 13	$f_{po} =$		169.6 ksi
layer 14	$f_{po} =$		169.6 ksi



strain in flexural tension

		at midspan	at endspan
layer 1	$\epsilon_x =$	0.002000	0.002000
layer 2	$\epsilon_x =$	0.002000	0.002000
layer 3	$\epsilon_x =$	0.002000	0.002000
layer 4	$\epsilon_x =$	0.002000	0.002000
layer 5	$\epsilon_x =$	0.002000	
layer 6	$\epsilon_x =$	0.002000	
layer 7	$\epsilon_x =$	0.002000	
layer 8	$\epsilon_x =$	0.002000	
layer 9	$\epsilon_x =$		0.002000
layer 10	$\epsilon_x =$		0.002000
layer 11	$\epsilon_x =$		0.002000
layer 12	$\epsilon_x =$		0.002000
layer 13	$\epsilon_x =$		0.002000
layer 14	$\epsilon_x =$		0.002000

### Deflection and Camber

Deflection due to Prestressing Force at Transfer  
 Deflection due to Beam Self-Weight at Transfer  
 Deflection due to Beam Self-Weight at Erection  
 Deflection due to Haunch and Deck

		at midspan	at endspan
$\Delta_p =$		3.27 in	3.29 in
$\Delta_g =$		-1.82 in	
$\Delta_g =$		-1.61 in	
$\Delta_s =$		-2.46 in	

Deflection due to total self weight

$\Delta_{sw} =$		-0.80 in	
-----------------	--	----------	--

Total Deflection at transfer

$\Delta =$		1.45 in	1.47 in
------------	--	---------	---------

Total Deflection at erection

$\Delta =$		2.92 in	2.95 in
------------	--	---------	---------

Live load deflection limit = span/800

$=$		-1.80 in	
-----	--	----------	--

Deflection due to live load and impact

$\Delta_L =$		-0.99 in	
--------------	--	----------	--

OK

Deflection due to fire truck

$\Delta_L =$		-1.8262 in	
--------------	--	------------	--

Total Deflection after fire with fire truck

$\Delta =$		0.6518 in	
------------	--	-----------	--

NOT OK

**Location: Fire at Critical Positive Moment Sections**  
**Beam Design: 3/8" Strand**  
**Fire Exposure Status: 1-1/2 Hour**

(PCI Bridge Design Manual Section 9.6)

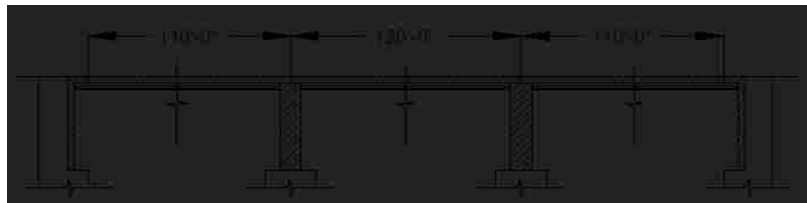


**Material Properties**

CAST-IN-PLACE SLAB			
Actual Thickness	$t_{as} =$		8.0 in
Wearing Surface	$=$		0.5 in
Structural thickness = Actual - Wearing Surface	$t_s =$		7.5 in
Compressive Strength	$f'_c =$		4 ksi
Unit Weight	$w_c =$		150.0 pcf
Stress factor of compression block	$\beta_1 =$		0.85

BEAMS: AASHTO-PCI, BT-72 BULB-TEE			
Strength at release	$f_{ci} =$		5.5 ksi
Strength at 28 days	$f'_c =$		6.41 ksi
Unit Weight	$w_c =$		150.0 pcf
Overall Beam Length:			
@ end spans	$L =$		110 ft
@ center span	$L =$		119 ft
Design Spans:			
Non-composite beam @ end spans	$L =$		109 ft
Non-composite beam @ center span	$L =$		118 ft
Composite beam @ end spans	$L =$		110 ft
Composite beam @ center span	$L =$		120 ft
Beam Spacing	$S =$		12 ft



**PRESTRESSING STRANDS**

Diameter of single strand	d =	0.4 in
Area of single strand	A =	0.085 in <sup>2</sup>

Temperature of Layer

layer 1 (bottom)	T =	700.00 °F
layer 2	T =	500.00 °F
layer 3	T =	400.00 °F
layer 4	T =	370.00 °F
layer 5	T =	345.00 °F
layer 6	T =	300.00 °F
layer 7	T =	280.00 °F
layer 8	T =	260.00 °F
layer 9	T =	245.00 °F
layer 10	T =	68.00 °F
layer 11	T =	68.00 °F
layer 12	T =	68.00 °F
layer 13	T =	68.00 °F
layer 14	T =	68.00 °F

Ultimate Strength

initial = 284 ksi

layer 1 (bottom)	f <sub>pu</sub> =	261 ksi
layer 2	f <sub>pu</sub> =	281 ksi
layer 3	f <sub>pu</sub> =	284 ksi
layer 4	f <sub>pu</sub> =	284 ksi
layer 5	f <sub>pu</sub> =	284 ksi
layer 6	f <sub>pu</sub> =	284 ksi
layer 7	f <sub>pu</sub> =	284 ksi
layer 8	f <sub>pu</sub> =	284 ksi
layer 9	f <sub>pu</sub> =	284 ksi
layer 10	f <sub>pu</sub> =	284 ksi
layer 11	f <sub>pu</sub> =	284 ksi
layer 12	f <sub>pu</sub> =	284 ksi
layer 13	f <sub>pu</sub> =	284 ksi
layer 14	f <sub>pu</sub> =	284 ksi

Yield Strength

initial = 257 ksi

layer 1 (bottom)	f <sub>py</sub> =	221 ksi
layer 2	f <sub>py</sub> =	244 ksi
layer 3	f <sub>py</sub> =	247 ksi
layer 4	f <sub>py</sub> =	249 ksi
layer 5	f <sub>py</sub> =	249 ksi
layer 6	f <sub>py</sub> =	252 ksi
layer 7	f <sub>py</sub> =	252 ksi
layer 8	f <sub>py</sub> =	252 ksi
layer 9	f <sub>py</sub> =	252 ksi
layer 10	f <sub>py</sub> =	257 ksi
layer 11	f <sub>py</sub> =	257 ksi
layer 12	f <sub>py</sub> =	257 ksi
layer 13	f <sub>py</sub> =	257 ksi
layer 14	f <sub>py</sub> =	257 ksi

**Stress Limits:**

before transfer ≤ 0.75f<sub>pu</sub> (initial = 202.5)

layer 1 (bottom)	f <sub>pl</sub> =	196.1 ksi
layer 2	f <sub>pl</sub> =	211.0 ksi
layer 3	f <sub>pl</sub> =	213.2 ksi
layer 4	f <sub>pl</sub> =	213.2 ksi
layer 5	f <sub>pl</sub> =	213.2 ksi
layer 6	f <sub>pl</sub> =	213.2 ksi
layer 7	f <sub>pl</sub> =	213.2 ksi
layer 8	f <sub>pl</sub> =	213.2 ksi
layer 9	f <sub>pl</sub> =	213.2 ksi
layer 10	f <sub>pl</sub> =	213.2 ksi
layer 11	f <sub>pl</sub> =	213.2 ksi
layer 12	f <sub>pl</sub> =	213.2 ksi
layer 13	f <sub>pl</sub> =	213.2 ksi
layer 14	f <sub>pl</sub> =	213.2 ksi



**COMPOSITE BEAM AT MIDSPAN**

Effective Flange Width	$b_f =$	111.0 in	*min of three criteria
Modular Ratio = $E_{cs}/E_c$	$n =$	0.7900	
Transformed flange width	$=$	87.7 in	
Transformed flange area	$=$	657.6 in <sup>2</sup>	
Transformed haunch width	$=$	33.2 in	
Transformed haunch area	$=$	16.6 in <sup>2</sup>	

	Transformed Area	$y_b$	$Ay_b$	$A(y_{bc}-y_b)^2$	I	$I + A(y_{bc}-y_b)^2$
Beam	767.0 in <sup>2</sup>	41.52 in	31,845.8 in <sup>3</sup>	201,319 in <sup>4</sup>	412,327 in <sup>4</sup>	613,646 in <sup>4</sup>
Haunch	16.6 in <sup>2</sup>	72.25 in	1,198.6 in <sup>3</sup>	3,502 in <sup>4</sup>	0.33 in <sup>4</sup>	3,502 in <sup>4</sup>
Deck	657.6 in <sup>2</sup>	76.25 in	50,144.7 in <sup>3</sup>	225,779 in <sup>4</sup>	2,950 in <sup>4</sup>	228,728 in <sup>4</sup>
Total	1441.2 in <sup>2</sup>		83,189.1 in <sup>3</sup>			845,877 in <sup>4</sup>

Total area of Composite Section	$A_c =$	1441 in <sup>2</sup>
Overall Depth of the Composite Section	$h_c =$	80 in
Moment of Inertia	$I_c =$	845,877 in <sup>4</sup>
Distance from centroid to extreme <u>bottom</u> fiber of beam	$y_{bc} =$	57.72 in
Distance from centroid to extreme <u>top</u> fiber of beam	$y_{tg} =$	14.28 in
Distance from centroid to extreme <u>top</u> fiber of slab	$y_{tc} =$	22.28 in
Section modulus for the extreme <u>bottom</u> fiber of beam	$S_{bc} =$	14,654.5 in <sup>3</sup>
Section modulus for the extreme <u>top</u> fiber of beam	$S_{tg} =$	59,239.7 in <sup>3</sup>
Section modulus for the extreme <u>top</u> fiber slab	$S_{tc} =$	48,063.2 in <sup>3</sup>

**Shear Forces and Bending Moments**

**DEAD LOADS**

Beam self-weight	$w_{beam} =$	0.799 k/f
8 in. deck weight	$w_{deck} =$	1.200 k/f
1/2 in. haunch weight	$w_{haunch} =$	0.022 k/f

LRFD Specifications: Art. 4.6.2.2.1

Width of Deck Constant		OK
Number of beams is not less than four $N_b =$	4	OK
Roadway part of the overhang, $d_o \leq 3.0$ ft, $d_o =$	1.5	OK
Curvature in plans is less than $4^\circ =$	0	OK
Cross-section of the bridge is consistent with one of the cross sections given by LRFD specs		OK

Barrier and wearing surface loads are equally distributed among the 4 beams

Barrier Wt	$Wt =$	0.150 k/f
Dead load of future wearing surface	$DW =$	0.263 k/f

**LIVE LOADS**

Fire truck live load front load (Point A)	$P_{live} =$	48.0 kips
Fire truck live load back load (Point B)	$P_{live} =$	22.0 kips
distance between two loads		19.2 ft
distance from nearest edge to point A	$x_a =$	59.0 ft
distance from nearest edge to point B	$x_b =$	39.8 ft

LRFD Specifications: Art. 4.6.2.2.1

Width of Deck Constant		OK
Number of beams is not less than four $N_b =$	4	OK
Beams are parallel and approximately of the same stiffness		OK
Roadway part of the overhang, $d_o \leq 3.0$ ft, $d_o =$	1.5	OK
Curvature in plans is less than $4^\circ =$	0	OK

Barrier and wearing surface loads are equally distributed among the 4 beams

Bridge Type-- "k" (LRFD Table 4.6.2.2.1-1)		
Number of design lanes = $w/12$	$=$	3 lanes

**Distribution Factor for Bending Moment:**

Beams spacing	S =	12.0 ft
Depth of concrete slab	t <sub>s</sub> =	7.5 in
Beam Span	L =	120.0 ft
Number of Beams	N <sub>b</sub> =	4
Modular ratio between beam & deck materials	n =	1.2659
Longitudinal stiffness parameter	K <sub>g</sub> =	2,048,407.27 in <sup>4</sup>

at center span:

$$DFM = 0.75 + \left(\frac{S}{9.5}\right)^{1.6} * \left(\frac{S}{L}\right)^{0.1} * \left(\frac{K_g}{12 * L * t_s^3}\right)^{0.1}$$

DFM =	0.895 lanes/beam
-------	------------------

one design lane loaded:

$$DFM = 0.75 + \left(\frac{S}{14}\right)^{1.6} * \left(\frac{S}{L}\right)^{0.1} * \left(\frac{K_g}{12 * L * t_s^3}\right)^{0.1}$$

DFM =	0.607 lanes/beam
-------	------------------

0.905 Controls

**Distribution Factor for Shear Force**

both end spans and center span:

$$DFV = 0.2 + \left(\frac{S}{12}\right) - \left(\frac{S}{35}\right)^2$$

DFV =	1.082 lanes/beam
-------	------------------

one design lane loaded:

$$DFV = 0.36 + \left(\frac{S}{25}\right)$$

DFV =	0.840 lanes/beam
-------	------------------

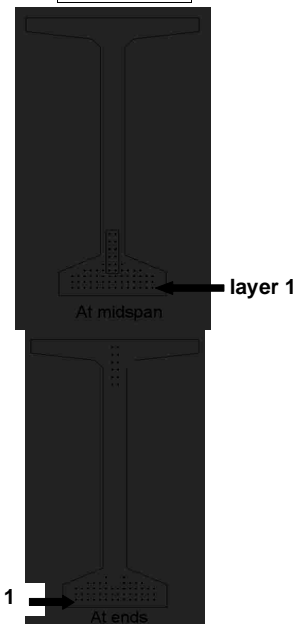
1.082 Controls

from bottom	At Midspan		At Ends	
	No. of	Distance from Bottom	No. of	Distance from Bottom
layer 1	14	2	14	2
layer 2	14	3.5	14	3.5
layer 3	14	5	14	5
layer 4	10	6.5	8	6.5
layer 5	4	8	2	8
layer 6	2	10	-	-
layer 7	2	12	-	-
layer 8	2	14	-	-
layer 9	2	16	2	60
layer 10	-	-	2	62
layer 11	-	-	2	64
layer 12	-	-	2	66
layer 13	-	-	2	68
layer 14	-	-	2	70
	64		64	
<b>Harped Strand Group (included in above totals)</b>				
layer 3	2	6		
layer 4	2	8		
layer 5	2	10		
layer 6	2	12		
layer 7	2	14		
layer 8	2	16		

distance from the center of gravity of strands to the bottom fiber of the beam = 7% of the beam depth  
strand eccentricity at midspan = (y<sub>c</sub> - y<sub>bs</sub>)

y <sub>bs</sub> =	5.44 in
e <sub>c</sub> =	36.08 in

layer 1



## Prestress Losses

### ELASTIC SHORTENING

assumed loss	=	6.00%
Force per strand at transfer		
layer 1	=	15.7 kips
layer 2	=	16.9 kips
layer 3	=	17.0 kips
layer 4	=	17.0 kips
layer 5	=	17.0 kips
layer 6	=	17.0 kips
layer 7	=	17.0 kips
layer 8	=	17.0 kips
layer 9	=	17.0 kips
layer 10	=	17.0 kips
layer 11	=	17.0 kips
layer 12	=	17.0 kips
layer 13	=	17.0 kips
layer 14	=	17.0 kips

		at midspan	at endspan
Total prestressing force at release	$P_i =$	1068.4 kips	1034.4 kips
Sum of concrete stresses at the center of gravity of prestressing tendons due to prestressing force at transfer and the self-weight of the member at sections of maximum moment	$f_{cgp} =$	3.306 ksi	3.154 ksi
Loss due to shortening		at midspan	at endspan
layer 1	$\Delta f_{pES} =$	20.4 ksi	19.4 ksi
layer 2	$\Delta f_{pES} =$	20.4 ksi	19.4 ksi
layer 3	$\Delta f_{pES} =$	20.2 ksi	19.3 ksi
layer 4	$\Delta f_{pES} =$	20.0 ksi	19.1 ksi
layer 5	$\Delta f_{pES} =$	20.0 ksi	19.1 ksi
layer 6	$\Delta f_{pES} =$	19.8 ksi	
layer 7	$\Delta f_{pES} =$	19.8 ksi	
layer 8	$\Delta f_{pES} =$	19.6 ksi	
layer 9	$\Delta f_{pES} =$	19.6 ksi	18.7 ksi
layer 10	$\Delta f_{pES} =$		18.2 ksi
layer 11	$\Delta f_{pES} =$		18.2 ksi
layer 12	$\Delta f_{pES} =$		18.2 ksi
layer 13	$\Delta f_{pES} =$		18.2 ksi
layer 14	$\Delta f_{pES} =$		18.2 ksi

### SHRINKAGE

Shrinkage = $(17 - 0.15 \cdot \text{Relative Humidity})$	$\Delta f_{pSR} =$	6.5 ksi	← assume relative humidity = 70%
--	--------------------	---------	----------------------------------

### CREEP OF CONCRETE

Change of stresses at center of gravity of prestressing due to permanent loads except the loads acting at time of applying prestressing force, calculated at the same section as $f_{cgp}$	$\Delta f_{cgp} =$	2.383 ksi	
loss due to creep	$\Delta f_{pCR} =$	at midspan 23.0 ksi	at endspan 21.2 ksi

**RELAXATION OF PRESTRESSING STRANDS**

loss due to relaxation after transfer		at midspan	at endspan
layer 1	$\Delta f_{PR2} =$	1.8 ksi	1.9 ksi
layer 2	$\Delta f_{PR2} =$	1.8 ksi	1.9 ksi
layer 3	$\Delta f_{PR2} =$	1.8 ksi	1.9 ksi
layer 4	$\Delta f_{PR2} =$	1.8 ksi	1.9 ksi
layer 5	$\Delta f_{PR2} =$	1.8 ksi	1.9 ksi
layer 6	$\Delta f_{PR2} =$	1.9 ksi	
layer 7	$\Delta f_{PR2} =$	1.9 ksi	
layer 8	$\Delta f_{PR2} =$	1.9 ksi	
layer 9	$\Delta f_{PR2} =$	1.9 ksi	2.0 ksi
layer 10	$\Delta f_{PR2} =$		2.0 ksi
layer 11	$\Delta f_{PR2} =$		2.0 ksi
layer 12	$\Delta f_{PR2} =$		2.0 ksi
layer 13	$\Delta f_{PR2} =$		2.0 ksi
layer 14	$\Delta f_{PR2} =$		2.0 ksi

**TOTAL LOSSES AT TRANSFER**

total loss  $\Delta f_{pES} = \Delta f_{pt}$

stress in tendons after transfer  $f_{pt} = f_{pr} - \Delta f_{pt}$

		at midspan	at endspan
layer 1	$f_{pt} =$	175.7 ksi	176.7 ksi
layer 2	$f_{pt} =$	190.6 ksi	191.6 ksi
layer 3	$f_{pt} =$	193.0 ksi	193.9 ksi
layer 4	$f_{pt} =$	193.2 ksi	194.1 ksi
layer 5	$f_{pt} =$	193.2 ksi	194.1 ksi
layer 6	$f_{pt} =$	193.3 ksi	
layer 7	$f_{pt} =$	193.3 ksi	
layer 8	$f_{pt} =$	193.5 ksi	
layer 9	$f_{pt} =$	193.5 ksi	194.4 ksi
layer 10	$f_{pt} =$		195.0 ksi
layer 11	$f_{pt} =$		195.0 ksi
layer 12	$f_{pt} =$		195.0 ksi
layer 13	$f_{pt} =$		195.0 ksi
layer 14	$f_{pt} =$		195.0 ksi

force per strand =  $f_{pt} \cdot \text{strand area}$

		at midspan	at endspan
layer 1	=	14.9 kips	15.0 kips
layer 2	=	16.2 kips	16.3 kips
layer 3	=	16.4 kips	16.5 kips
layer 4	=	16.4 kips	16.5 kips
layer 5	=	16.4 kips	16.5 kips
layer 6	=	16.4 kips	
layer 7	=	16.4 kips	
layer 8	=	16.5 kips	
layer 9	=	16.5 kips	16.5 kips
layer 10	=		16.6 kips
layer 11	=		16.6 kips
layer 12	=		16.6 kips
layer 13	=		16.6 kips
layer 14	=		16.6 kips

Total prestressing force after transfer  $P_i =$  993.2 kips 1000.2 kips



Initial loss =  $(\Delta f_p)/(f_{pi})$

		at midspan	at endspan
layer 1	% =	10.4%	9.9%
layer 2	% =	9.7%	9.2%
layer 3	% =	9.5%	9.0%
layer 4	% =	9.4%	9.0%
layer 5	% =	9.4%	9.0%
layer 6	% =	9.3%	
layer 7	% =	9.3%	
layer 8	% =	9.2%	
layer 9	% =	9.2%	8.8%
layer 10	% =		8.5%
layer 11	% =		8.5%
layer 12	% =		8.5%
layer 13	% =		8.5%
layer 14	% =		8.5%

OK  
OK  
OK  
OK  
OK  
OK  
OK  
OK  
OK  
OK  
OK  
OK  
OK

**TOTAL LOSSES AT SERVICE LOADS**

Total Losses		at midspan	at endspan
layer 1	$\Delta f_{pT} =$	51.7 ksi	50.7 ksi
layer 2	$\Delta f_{pT} =$	51.7 ksi	50.7 ksi
layer 3	$\Delta f_{pT} =$	51.5 ksi	50.5 ksi
layer 4	$\Delta f_{pT} =$	51.3 ksi	50.4 ksi
layer 5	$\Delta f_{pT} =$	51.3 ksi	50.4 ksi
layer 6	$\Delta f_{pT} =$	51.1 ksi	
layer 7	$\Delta f_{pT} =$	51.1 ksi	
layer 8	$\Delta f_{pT} =$	50.9 ksi	
layer 9	$\Delta f_{pT} =$	50.9 ksi	50.0 ksi
layer 10	$\Delta f_{pT} =$		49.5 ksi
layer 11	$\Delta f_{pT} =$		49.5 ksi
layer 12	$\Delta f_{pT} =$		49.5 ksi
layer 13	$\Delta f_{pT} =$		49.5 ksi
layer 14	$\Delta f_{pT} =$		49.5 ksi

Stress in tendon after all losses =  $f_{pe} = f_{pi} - \Delta f_{pT}$

		at midspan	at endspan
layer 1	$f_{pe} =$	144.4 ksi	145.4 ksi
layer 2	$f_{pe} =$	159.4 ksi	160.3 ksi
layer 3	$f_{pe} =$	161.7 ksi	162.6 ksi
layer 4	$f_{pe} =$	161.9 ksi	162.8 ksi
layer 5	$f_{pe} =$	161.9 ksi	162.8 ksi
layer 6	$f_{pe} =$	162.1 ksi	
layer 7	$f_{pe} =$	162.1 ksi	
layer 8	$f_{pe} =$	162.3 ksi	
layer 9	$f_{pe} =$	162.3 ksi	163.2 ksi
layer 10	$f_{pe} =$		163.7 ksi
layer 11	$f_{pe} =$		163.7 ksi
layer 12	$f_{pe} =$		163.7 ksi
layer 13	$f_{pe} =$		163.7 ksi
layer 14	$f_{pe} =$		163.7 ksi

check prestressing stress limit at service limit state:  $f_{pe} \leq 0.8 \cdot f_{py}$

layer 1	=	176.7 ksi
layer 2	=	195.2 ksi
layer 3	=	197.2 ksi
layer 4	=	199.3 ksi
layer 5	=	199.3 ksi
layer 6	=	201.3 ksi
layer 7	=	201.3 ksi
layer 8	=	201.3 ksi
layer 9	=	201.3 ksi
layer 10	=	205.4 ksi
layer 11	=	205.4 ksi
layer 12	=	205.4 ksi
layer 13	=	205.4 ksi
layer 14	=	205.4 ksi

OK  
OK  
OK  
OK  
OK  
OK  
OK  
OK  
OK  
OK  
OK  
OK  
OK  
OK

force per strand =  $f_{pe}$  \* strand area

		at midspan	at endspan
layer 1	=	12.3 kips	12.4 kips
layer 2	=	13.5 kips	13.6 kips
layer 3	=	13.7 kips	13.8 kips
layer 4	=	13.8 kips	13.8 kips
layer 5	=	13.8 kips	13.8 kips
layer 6	=	13.8 kips	
layer 7	=	13.8 kips	
layer 8	=	13.8 kips	
layer 9	=	13.8 kips	13.9 kips
layer 10	=		13.9 kips
layer 11	=		13.9 kips
layer 12	=		13.9 kips
layer 13	=		13.9 kips
layer 14	=		13.9 kips

Total prestressing force after all losses  
Final losses, % =  $(\Delta f_{pt}) / (f_{pi})$

		at midspan	at endspan
$P_{pe}$ =		856.8 kips	862.5 kips
layer 1	% =	26.3%	25.9%
layer 2	% =	26.3%	25.9%
layer 3	% =	26.2%	25.8%
layer 4	% =	26.1%	25.7%
layer 5	% =	26.1%	25.7%
layer 6	% =	26.1%	
layer 7	% =	26.1%	
layer 8	% =	26.0%	
layer 9	% =	26.0%	25.5%
layer 10	% =		25.2%
layer 11	% =		25.2%
layer 12	% =		25.2%
layer 13	% =		25.2%
layer 14	% =		25.2%
Average final losses, %	% =	26.1%	25.5%

### Stresses at Transfer

#### STRESS LIMITS FOR CONCRETE

Compression = $0.6f_{ci}$	$f_{ci}$ =	3.300 ksi
Tension		
without bonded reinforcement = $-0.0948\sqrt{f_{ci}} \leq -0.2$	=	-0.200 ksi
with bonded auxiliary reinforcement = $-0.22\sqrt{f_{ci}}$	=	-0.016 ksi

#### STRESSES AT TRANSFER LENGTH SECTION

Transfer Length = $60 \times$ (strand diameter)	=	1.9 ft	} Calcs for eccentricity (see 9.6.7.2)
Bending moment at transfer length	$M_g$ =	87.7 ft-kips	
center of 12 strands to top fiber of beam at the end	=	7.00 in	
center of 12 strands to bottom fiber of beam at the harp point	=	11.00 in	
center of 12 strands and top fiber of beam at transfer length	=	9.84 in	
center of gravity of 32 strands and bottom fiber of beam	=	3.98 in	
center of gravity of all strands and the bottom fiber of beam at transfer length	=	15.24 in	
center of gravity of all strands and the bottom fiber of beam at the end	=	15.30 in	
Eccentricity of the strand group at transfer length:	$e_n$ =	26.28 in	
Eccentricity at end of beam:	$e$ =	26.22 in	

$$f_t = \frac{P_i}{A} - \frac{P_i e}{S_t} + \frac{M_g}{S_t}$$

$$f_b = \frac{P_i}{A} + \frac{P_i e}{S_b} - \frac{M_g}{S_b}$$

		at midspan	at endspan
Top stress at top fiber of beam	$f_t$ =	-0.329 ksi	-0.332 ksi
Bottom stress at bottom fiber of the beam	$f_b$ =	3.205 ksi	3.205 ksi

OK  
OK

STRESSES AT HARP POINT			
Bending moment due to beam weight at 0.3L	$M_g =$	1188.0 ft-kips	
Top stress at top fiber of beam	$f_t =$	-0.105 ksi	-0.112 ksi
Bottom stress at bottom fiber of the beam	$f_b =$	3.022 ksi	2.768 ksi

OK  
OK

STRESSES AT MIDSPAN			
Bending moment due to beam weight at 0.5L	$M_g =$	1414.3 ft-kips	
Top stress at top fiber of beam	$f_t =$	-0.006 ksi	0.064 ksi
Bottom stress at bottom fiber of the beam	$f_b =$	2.840 ksi	2.586 ksi

OK  
OK

#### HOLD-DOWN FORCES

assume stress in strand before losses =  $0.8f_u$

layer 1	=	209.2 ksi
layer 2	=	225.1 ksi
layer 3	=	227.4 ksi
layer 4	=	227.4 ksi
layer 5	=	227.4 ksi
layer 6	=	227.4 ksi
layer 7	=	227.4 ksi
layer 8	=	227.4 ksi
layer 9	=	227.4 ksi
layer 10	=	227.4 ksi
layer 11	=	227.4 ksi
layer 12	=	227.4 ksi
layer 13	=	227.4 ksi
layer 14	=	227.4 ksi

prestress force per strand before any losses:

layer 1	=	17.8 kips
layer 2	=	19.1 kips
layer 3	=	19.3 kips
layer 4	=	19.3 kips
layer 5	=	19.3 kips
layer 6	=	19.3 kips
layer 7	=	19.3 kips
layer 8	=	19.3 kips
layer 9	=	19.3 kips
layer 10	=	19.3 kips
layer 11	=	19.3 kips
layer 12	=	19.3 kips
layer 13	=	19.3 kips
layer 14	=	19.3 kips
Harp Angle	$\psi =$	7.2 °

Hold-down force/strand

layer 1	=	2.3 kips/strand
layer 2	=	2.5 kips/strand
layer 3	=	2.5 kips/strand
layer 4	=	2.5 kips/strand
layer 5	=	2.5 kips/strand
layer 6	=	2.5 kips/strand
layer 7	=	2.5 kips/strand
layer 8	=	2.5 kips/strand
layer 9	=	2.5 kips/strand
layer 10	=	2.5 kips/strand
layer 11	=	2.5 kips/strand
layer 12	=	2.5 kips/strand
layer 13	=	2.5 kips/strand
layer 14	=	2.5 kips/strand
Total hold-down force	=	30.45 kips

### Stresses at Service Loads

#### STRESS LIMITS FOR CONCRETE

##### Compression:

Due to permanent loads for load combination Service I

for the precast beam	=	2.885 ksi
for deck	=	1.800 ksi

Due to permanent and transient loads for load combination Service I

for the precast beam	=	3.846 ksi
for deck	=	2.400 ksi

##### Tension:

Load Combination Service III

for the precast beam	=	-0.015 ksi
----------------------	---	------------

#### STRESSES AT MIDSPAN

Compression stresses at top fiber of beam	at midspan	at endspan		
$f_t = \frac{P_{ps}}{A} - \frac{P_{ps}e}{S_t} + \frac{(M_x + M_{s1})}{S_t} + \frac{(M_w + M_b)}{S_{tw}}$				
Due to permanent loads	$f_{tg} =$	1.890 ksi	1.884 ksi	OK
$f_{tr} = \frac{P_{ps}}{A} - \frac{P_{ps}e}{S_t} + \frac{(M_x + M_{s1})}{S_t} + \frac{(M_w - M_b)}{S_{tw}} + \frac{(M_{L+1})}{S_{tr}}$				
Due to permanent loads and transient loads	$f_{tg} =$	2.319 ksi	2.313 ksi	OK
Compression stresses at top fiber of deck	at midspan	at endspan		
$f_{tc} = \frac{(M_w + M_b)}{S_{tr}}$				
Due to permanent loads	$f_{tc} =$	0.050 ksi	0.050 ksi	OK
$f_{tr} = \frac{(M_w + M_b + M_{L+1})}{S_{tr}}$				
Due to permanent loads and transient loads	$f_{tc} =$	0.578 ksi	0.578 ksi	OK
Tension stresses at top fiber of deck	at midspan	at endspan		
$f_{tr} = \frac{P_{ps}}{A} + \frac{P_{ps}e}{S_b} - \frac{(M_x + M_{s1})}{S_b} - \frac{(M_w + M_b + 0.8 * M_{L+1})}{S_{tr}}$				
Load Combination Service III	$f_b =$	-1.190 ksi	-1.169 ksi	OK

### Strength Limit State

#### POSITIVE MOMENT SECTION

$M_u = 1.25DC + 1.5DW + 1.75(LL + IM)$	$M_u =$	8381.5 ft-kips
--	---------	----------------

effective length factor for compression members

layer 1	k =	0.39
layer 2	k =	0.35
layer 3	k =	0.35
layer 4	k =	0.33
layer 5	k =	0.33
layer 6	k =	0.31
layer 7	k =	0.31
layer 8	k =	0.31
layer 9	k =	0.31
layer 10	k =	0.27
layer 11	k =	0.27
layer 12	k =	0.27
layer 13	k =	0.27
layer 14	k =	0.27
c =		4.5 ft-kips

average stress in prestressing steel

layer 1	$f_{ps} =$	255.3 ksi
layer 2	$f_{ps} =$	274.7 ksi
layer 3	$f_{ps} =$	277.5 ksi
layer 4	$f_{ps} =$	277.5 ksi
layer 5	$f_{ps} =$	277.5 ksi
layer 6	$f_{ps} =$	277.5 ksi
layer 7	$f_{ps} =$	277.5 ksi
layer 8	$f_{ps} =$	277.5 ksi
layer 9	$f_{ps} =$	277.5 ksi
layer 10	$f_{ps} =$	277.5 ksi
layer 11	$f_{ps} =$	277.5 ksi
layer 12	$f_{ps} =$	277.5 ksi
layer 13	$f_{ps} =$	277.5 ksi
layer 14	$f_{ps} =$	277.5 ksi

nominal flexure resistance

	$a =$	3.85 in
$M_r = \Phi M_n, \Phi = 1.00$	$\Phi M_n =$	8948.7 ft-kips
$M = DC+W+LL+IM$	$M =$	5833.6 ft-kips

OK  
OK

**NEGATIVE MOMENT SECTION**

$M_u = 1.25DC+1.5DW+1.75(LL+IM)$	$M_u =$	4837.2 ft-kips
	$a =$	6.26 in
	$\Phi M_n =$	4861.4 ft-kips
$M = DC+W+LL+IM$	$M =$	2869.7 ft-kips

OK  
OK

**Shear Design**

**CRITICAL SECTION AT 0.59**

$V_u = 1.25DC+1.5DW+1.75(LL+IM)$	$V_u =$	405.0 kips
$M_u = 1.25DC+1.5DW+1.75(LL+IM)$	$M_u =$	-2684.4 ft-kips
or		
$V_u = 1.25DC+1.5DW+1.75(LL+IM)$	$V_u =$	364.8 kips
$M_u = 1.25DC+1.5DW+1.75(LL+IM)$	$M_u =$	-2877.0 ft-kips
max shear	$V_u =$	405.0 kips
max moment	$M_u =$	2877.0 ft-kips
Shear depth	$d_v =$	73.19 in
Applied factored normal force at the section	$N_u =$	0
Angle of diagonal compressive stresses	$\theta =$	36.00 °

**STRAIN IN FLEXURAL TENSION REINFORCEMENT**

$$\epsilon_s = \frac{\frac{M_u}{d_v} + 0.5N_u + 0.25V_u \cot \theta + A_{ps}j_{ps}}{E_s A_s + E_p A_{ps}} \leq 0.002$$

resultant compressive stress at centroid

	<b>at midspan</b>	<b>at endspan</b>
$f_{pc} =$	0.644 ksi	0.646 ksi

effective stress in prestressing strand after all losses

layer 1	$f_{po} =$	148.1 ksi	149.1 ksi
layer 2	$f_{po} =$	163.0 ksi	164.0 ksi
layer 3	$f_{po} =$	165.3 ksi	166.3 ksi
layer 4	$f_{po} =$	165.5 ksi	166.4 ksi
layer 5	$f_{po} =$	165.5 ksi	
layer 6	$f_{po} =$	165.6 ksi	
layer 7	$f_{po} =$	165.6 ksi	
layer 8	$f_{po} =$	165.8 ksi	
layer 9	$f_{po} =$		166.7 ksi
layer 10	$f_{po} =$		167.1 ksi
layer 11	$f_{po} =$		167.1 ksi
layer 12	$f_{po} =$		167.1 ksi
layer 13	$f_{po} =$		167.1 ksi
layer 14	$f_{po} =$		167.1 ksi

strain in flexural tension

		at midspan	at endspan
layer 1	$\epsilon_x =$	0.002000	0.002000
layer 2	$\epsilon_x =$	0.002000	0.002000
layer 3	$\epsilon_x =$	0.002000	0.002000
layer 4	$\epsilon_x =$	0.002000	0.002000
layer 5	$\epsilon_x =$	0.002000	
layer 6	$\epsilon_x =$	0.002000	
layer 7	$\epsilon_x =$	0.002000	
layer 8	$\epsilon_x =$	0.002000	
layer 9	$\epsilon_x =$		0.002000
layer 10	$\epsilon_x =$		0.002000
layer 11	$\epsilon_x =$		0.002000
layer 12	$\epsilon_x =$		0.002000
layer 13	$\epsilon_x =$		0.002000
layer 14	$\epsilon_x =$		0.002000

### Deflection and Camber

		at midspan	at endspan
Deflection due to Prestressing Force at Transfer	$\Delta_p =$	3.27 in	3.29 in
Deflection due to Beam Self-Weight at Transfer	$\Delta_g =$	-1.94 in	
Deflection due to Beam Self-Weight at Erection	$\Delta_g =$	-1.74 in	
Deflection due to Haunch and Deck	$\Delta_s =$	-2.66 in	
Deflection due to total self weight	$\Delta_{sw} =$	-1.13 in	
Total Deflection at transfer	$\Delta =$	1.33 in	1.35 in
Total Deflection at erection	$\Delta =$	2.67 in	2.71 in
Live load deflection limit = span/800	$=$	-1.80 in	
Deflection due to live load and impact	$\Delta_L =$	-1.07 in	
Deflection due to fire truck	$\Delta_L =$	-1.9771 in	
Total Deflection after fire with fire truck	$\Delta =$	0.1649 in	

OK

NOT OK

**Location: Fire at Critical Positive Moment Sections**  
**Beam Design: 3/8" Strand**  
**Fire Exposure Status: 2 Hour**

(PCI Bridge Design Manual Section 9.6)

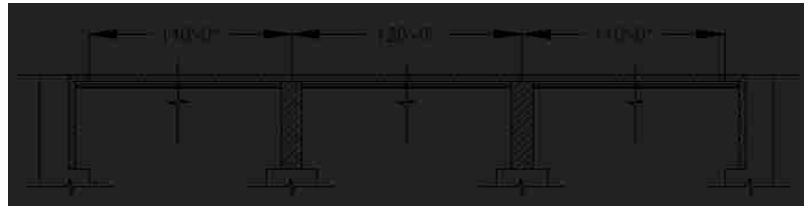


**Material Properties**

CAST-IN-PLACE SLAB			
Actual Thickness	$t_{as} =$		8.0 in
Wearing Surface	$=$		0.5 in
Structural thickness = Actual - Wearing Surface	$t_s =$		7.5 in
Compressive Strength	$f'_c =$		4 ksi
Unit Weight	$w_c =$		150.0 pcf
Stress factor of compression block	$\beta_1 =$		0.85

BEAMS: AASHTO-PCI, BT-72 BULB-TEE			
Strength at release	$f'_{ci} =$		5.5 ksi
Strength at 28 days	$f'_c =$		6.17 ksi
Unit Weight	$w_c =$		150.0 pcf
Overall Beam Length:			
@ end spans	$L =$		110 ft
@ center span	$L =$		119 ft
Design Spans:			
Non-composite beam @ end spans	$L =$		109 ft
Non-composite beam @ center span	$L =$		118 ft
Composite beam @ end spans	$L =$		110 ft
Composite beam @ center span	$L =$		120 ft
Beam Spacing	$S =$		12 ft



**PRESTRESSING STRANDS**

Diameter of single strand	d =	0.375 in
Area of single strand	A =	0.085 in <sup>2</sup>

Temperature of Layer	layer 1 (bottom)	T =	870.00 °F
	layer 2	T =	680.00 °F
	layer 3	T =	560.00 °F
	layer 4	T =	490.00 °F
	layer 5	T =	470.00 °F
	layer 6	T =	440.00 °F
	layer 7	T =	400.00 °F
	layer 8	T =	375.00 °F
	layer 9	T =	350.00 °F
	layer 10	T =	68.00 °F
	layer 11	T =	68.00 °F
	layer 12	T =	68.00 °F
	layer 13	T =	68.00 °F
	layer 14	T =	68.00 °F

Ultimate Strength initial = 284 ksi	layer 1 (bottom)	f <sub>pu</sub> =	230 ksi
	layer 2	f <sub>pu</sub> =	259 ksi
	layer 3	f <sub>pu</sub> =	276 ksi
	layer 4	f <sub>pu</sub> =	281 ksi
	layer 5	f <sub>pu</sub> =	281 ksi
	layer 6	f <sub>pu</sub> =	281 ksi
	layer 7	f <sub>pu</sub> =	284 ksi
	layer 8	f <sub>pu</sub> =	284 ksi
	layer 9	f <sub>pu</sub> =	284 ksi
	layer 10	f <sub>pu</sub> =	284 ksi
	layer 11	f <sub>pu</sub> =	284 ksi
	layer 12	f <sub>pu</sub> =	284 ksi
	layer 13	f <sub>pu</sub> =	284 ksi
	layer 14	f <sub>pu</sub> =	284 ksi

Yield Strength initial = 257 ksi	layer 1 (bottom)	f <sub>py</sub> =	203 ksi
	layer 2	f <sub>py</sub> =	223 ksi
	layer 3	f <sub>py</sub> =	236 ksi
	layer 4	f <sub>py</sub> =	244 ksi
	layer 5	f <sub>py</sub> =	244 ksi
	layer 6	f <sub>py</sub> =	247 ksi
	layer 7	f <sub>py</sub> =	247 ksi
	layer 8	f <sub>py</sub> =	249 ksi
	layer 9	f <sub>py</sub> =	249 ksi
	layer 10	f <sub>py</sub> =	257 ksi
	layer 11	f <sub>py</sub> =	257 ksi
	layer 12	f <sub>py</sub> =	257 ksi
	layer 13	f <sub>py</sub> =	257 ksi
	layer 14	f <sub>py</sub> =	257 ksi

**Stress Limits:**  
before transfer ≤ 0.75f<sub>pu</sub> (initial = 202.5)

layer 1 (bottom)	f <sub>pl</sub> =	172.7 ksi
layer 2	f <sub>pl</sub> =	194.0 ksi
layer 3	f <sub>pl</sub> =	206.8 ksi
layer 4	f <sub>pl</sub> =	211.0 ksi
layer 5	f <sub>pl</sub> =	211.0 ksi
layer 6	f <sub>pl</sub> =	211.0 ksi
layer 7	f <sub>pl</sub> =	213.2 ksi
layer 8	f <sub>pl</sub> =	213.2 ksi
layer 9	f <sub>pl</sub> =	213.2 ksi
layer 10	f <sub>pl</sub> =	213.2 ksi
layer 11	f <sub>pl</sub> =	213.2 ksi
layer 12	f <sub>pl</sub> =	213.2 ksi
layer 13	f <sub>pl</sub> =	213.2 ksi
layer 14	f <sub>pl</sub> =	213.2 ksi





**COMPOSITE BEAM AT MIDSPAN**

Effective Flange Width	$b_f =$	111.0 in	*min of three criteria
Modular Ratio = $E_{cs}/E_c$	$n =$	0.8052	
Transformed flange width	$=$	89.4 in	
Transformed flange area	$=$	670.3 in <sup>2</sup>	
Transformed haunch width	$=$	33.8 in	
Transformed haunch area	$=$	16.9 in <sup>2</sup>	

	Transformed Area	$y_b$	$Ay_b$	$A(y_{bc}-y_b)^2$	I	$I + A(y_{bc}-y_b)^2$
Beam	767.0 in <sup>2</sup>	43.67 in	33,494.9 in <sup>3</sup>	180,716 in <sup>4</sup>	363,218 in <sup>4</sup>	543,934 in <sup>4</sup>
Haunch	16.9 in <sup>2</sup>	72.25 in	1,221.6 in <sup>3</sup>	2,960 in <sup>4</sup>	0.33 in <sup>4</sup>	2,960 in <sup>4</sup>
Deck	670.3 in <sup>2</sup>	76.25 in	51,110.7 in <sup>3</sup>	199,002 in <sup>4</sup>	2,950 in <sup>4</sup>	201,951 in <sup>4</sup>
Total	1454.2 in <sup>2</sup>		85,827.2 in <sup>3</sup>			748,845 in <sup>4</sup>

Total area of Composite Section	$A_c =$	1454 in <sup>2</sup>
Overall Depth of the Composite Section	$h_c =$	80 in
Moment of Inertia	$I_c =$	748,845 in <sup>4</sup>
Distance from centroid to extreme <u>bottom</u> fiber of beam	$y_{bc} =$	59.02 in
Distance from centroid to extreme <u>top</u> fiber of beam	$y_{tb} =$	12.98 in
Distance from centroid to extreme <u>top</u> fiber of slab	$y_{tc} =$	20.98 in
Section modulus for the extreme <u>bottom</u> fiber of beam	$S_{bc} =$	12,688.0 in <sup>3</sup>
Section modulus for the extreme <u>top</u> fiber of beam	$S_{tb} =$	57,690.9 in <sup>3</sup>
Section modulus for the extreme <u>top</u> fiber slab	$S_{tc} =$	44,329.5 in <sup>3</sup>

**Shear Forces and Bending Moments**

**DEAD LOADS**

Beam self-weight	$w_{beam} =$	0.799 k/f
8 in. deck weight	$w_{deck} =$	1.200 k/f
1/2 in. haunch weight	$w_{haunch} =$	0.022 k/f

LRFD Specifications: Art. 4.6.2.2.1

Width of Deck Constant		OK
Number of beams is not less than four $N_b =$	4	OK
Roadway part of the overhang, $d_e \leq 3.0$ ft, $d_e =$	1.5	OK
Curvature in plans is less than $4^\circ =$	0	OK
Cross-section of the bridge is consistent with one of the cross sections given by LRFD specs		OK

Barrier and wearing surface loads are equally distributed among the 4 beams

Barrier Wt	$Wt =$	0.150 k/f
Dead load of future wearing surface	$DW =$	0.263 k/f

**LIVE LOADS**

Fire truck live load front load (Point A)	$P_{live} =$	48.0 kips
Fire truck live load back load (Point B)	$P_{live} =$	22.0 kips
distance between two loads		19.2 ft
distance from nearest edge to point A	$x_a =$	59.0 ft
distance from nearest edge to point B	$x_b =$	39.8 ft

LRFD Specifications: Art. 4.6.2.2.1

Width of Deck Constant		OK
Number of beams is not less than four $N_b =$	4	OK
Beams are parallel and approximately of the same stiffness		OK
Roadway part of the overhang, $d_e \leq 3.0$ ft, $d_e =$	1.5	OK
Curvature in plans is less than $4^\circ =$	0	OK

Barrier and wearing surface loads are equally distributed among the 4 beams

Bridge Type-- "k" (LRFD Table 4.6.2.2.1-1)

Number of design lanes = $w/12$	$=$	3 lanes
---------------------------------	-----	---------

**Distribution Factor for Bending Moment:**

Beams spacing	S =	12.0 ft
Depth of concrete slab	t <sub>s</sub> =	7.5 in
Beam Span	L =	120.0 ft
Number of Beams	N <sub>b</sub> =	4
Modular ratio between beam & deck materials	n =	1.2420
Longitudinal stiffness parameter	K <sub>g</sub> =	1,948,702.11 in <sup>4</sup>

at center span:

$$DFM = 0.75 + \left(\frac{S}{9.5}\right)^{0.6} * \left(\frac{S}{L}\right)^{1.2} * \left(\frac{K_g}{.2 * L * t_s^3}\right)^{0.1}$$

DFM =	0.891 lanes/beam
-------	------------------

one design lane loaded:

$$DFM = 0.75 + \left(\frac{N}{14}\right)^{1.4} * \left(\frac{N}{L}\right)^{0.3} * \left(\frac{K_g}{.13 * L * t_s^3}\right)^{0.1}$$

DFM =	0.604 lanes/beam
-------	------------------

0.905 Controls

**Distribution Factor for Shear Force**

both end spans and center span:

$$DFV = 0.2 + \left(\frac{N}{12}\right) - \left(\frac{S}{35}\right)^2$$

DFV =	1.082 lanes/beam
-------	------------------

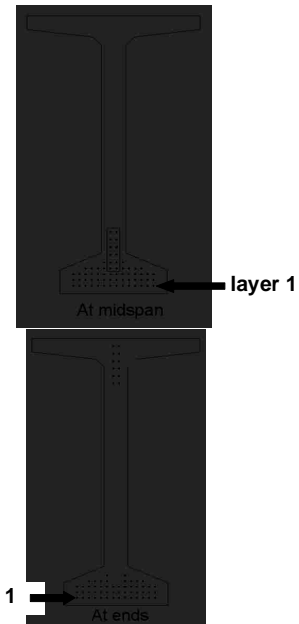
one design lane loaded:

$$DFV = 0.36 + \left(\frac{S}{25}\right)$$

DFV =	0.840 lanes/beam
-------	------------------

1.082 Controls

from bottom	At Midspan		At Ends	
	No. of	Distance from Bottom	No. of	Distance from Bottom
layer 1	14	2	14	2
layer 2	14	3.5	14	3.5
layer 3	14	5	14	5
layer 4	10	6.5	8	6.5
layer 5	4	8	2	8
layer 6	2	10	-	-
layer 7	2	12	-	-
layer 8	2	14	-	-
layer 9	2	16	2	60
layer 10	-	-	2	62
layer 11	-	-	2	64
layer 12	-	-	2	66
layer 13	-	-	2	68
layer 14	-	-	2	70
	64		64	
<b>Harped Strand Group (included in above totals)</b>				
layer 3	2	6		
layer 4	2	8		
layer 5	2	10		
layer 6	2	12		
layer 7	2	14		
layer 8	2	16		



distance from the center of gravity of strands to the bottom fiber of the beam = 7% of the beam depth  
strand eccentricity at midspan = (y<sub>c</sub> - y<sub>bs</sub>)

y <sub>bs</sub> =	5.44 in
e <sub>c</sub> =	38.23 in

layer 1

## Prestress Losses

### ELASTIC SHORTENING

assumed loss	=	6.00%
Force per strand at transfer		
layer 1	=	13.8 kips
layer 2	=	15.5 kips
layer 3	=	16.5 kips
layer 4	=	16.9 kips
layer 5	=	16.9 kips
layer 6	=	16.9 kips
layer 7	=	17.0 kips
layer 8	=	17.0 kips
layer 9	=	17.0 kips
layer 10	=	17.0 kips
layer 11	=	17.0 kips
layer 12	=	17.0 kips
layer 13	=	17.0 kips
layer 14	=	17.0 kips

Total prestressing force at release	$P_1 =$	at midspan 1013.6 kips	at endspan 980.4 kips
Sum of concrete stresses at the center of gravity of prestressing tendons due to prestressing force at transfer and the self-weight of the member at sections of maximum moment.	$f_{cgp} =$	3.644 ksi	3.467 ksi
Loss due to shortening		at midspan	at endspan
layer 1	$\Delta f_{pES} =$	22.0 ksi	21.0 ksi
layer 2	$\Delta f_{pES} =$	22.5 ksi	21.4 ksi
layer 3	$\Delta f_{pES} =$	22.5 ksi	21.4 ksi
layer 4	$\Delta f_{pES} =$	22.5 ksi	21.4 ksi
layer 5	$\Delta f_{pES} =$	22.5 ksi	21.4 ksi
layer 6	$\Delta f_{pES} =$	22.2 ksi	
layer 7	$\Delta f_{pES} =$	21.8 ksi	
layer 8	$\Delta f_{pES} =$	22.0 ksi	
layer 9	$\Delta f_{pES} =$	22.0 ksi	21.0 ksi
layer 10	$\Delta f_{pES} =$		20.0 ksi
layer 11	$\Delta f_{pES} =$		20.0 ksi
layer 12	$\Delta f_{pES} =$		20.0 ksi
layer 13	$\Delta f_{pES} =$		20.0 ksi
layer 14	$\Delta f_{pES} =$		20.0 ksi

### SHRINKAGE

Shrinkage = $(17 - 0.15 \cdot \text{Relative Humidity})$	$\Delta f_{pSR} =$	6.5 ksi	← assume relative humidity = 70%
--	--------------------	---------	----------------------------------

### CREEP OF CONCRETE

Change of stresses at center of gravity of prestressing due to permanent loads except the loads acting at time of applying prestressing force, calculated at the same section as $f_{cgp}$ .	$\Delta f_{cgp} =$	2.859 ksi	
loss due to creep	$\Delta f_{pCR} =$	at midspan 23.7 ksi	at endspan 21.6 ksi

**RELAXATION OF PRESTRESSING STRANDS**

loss due to relaxation after transfer		at midspan	at endspan
layer 1	$\Delta f_{pR2} =$	1.5 ksi	1.7 ksi
layer 2	$\Delta f_{pR2} =$	1.5 ksi	1.6 ksi
layer 3	$\Delta f_{pR2} =$	1.5 ksi	1.6 ksi
layer 4	$\Delta f_{pR2} =$	1.5 ksi	1.6 ksi
layer 5	$\Delta f_{pR2} =$	1.5 ksi	1.6 ksi
layer 6	$\Delta f_{pR2} =$	1.5 ksi	
layer 7	$\Delta f_{pR2} =$	1.6 ksi	
layer 8	$\Delta f_{pR2} =$	1.5 ksi	
layer 9	$\Delta f_{pR2} =$	1.5 ksi	1.7 ksi
layer 10	$\Delta f_{pR2} =$		1.8 ksi
layer 11	$\Delta f_{pR2} =$		1.8 ksi
layer 12	$\Delta f_{pR2} =$		1.8 ksi
layer 13	$\Delta f_{pR2} =$		1.8 ksi
layer 14	$\Delta f_{pR2} =$		1.8 ksi

**TOTAL LOSSES AT TRANSFER**

total loss  $\Delta f_{pES} = \Delta f_{pt}$

stress in tendons after transfer  $f_{pt} = f_{pr} - \Delta f_{pt}$

		at midspan	at endspan
layer 1	$f_{pt} =$	150.6 ksi	151.7 ksi
layer 2	$f_{pt} =$	171.5 ksi	172.6 ksi
layer 3	$f_{pt} =$	184.3 ksi	185.4 ksi
layer 4	$f_{pt} =$	188.6 ksi	189.6 ksi
layer 5	$f_{pt} =$	188.6 ksi	189.6 ksi
layer 6	$f_{pt} =$	188.8 ksi	
layer 7	$f_{pt} =$	191.3 ksi	
layer 8	$f_{pt} =$	191.1 ksi	
layer 9	$f_{pt} =$	191.1 ksi	192.2 ksi
layer 10	$f_{pt} =$		193.2 ksi
layer 11	$f_{pt} =$		193.2 ksi
layer 12	$f_{pt} =$		193.2 ksi
layer 13	$f_{pt} =$		193.2 ksi
layer 14	$f_{pt} =$		193.2 ksi

force per strand =  $f_{pt} \cdot \text{strand area}$

		at midspan	at endspan
layer 1	=	12.8 kips	12.9 kips
layer 2	=	14.6 kips	14.7 kips
layer 3	=	15.7 kips	15.8 kips
layer 4	=	16.0 kips	16.1 kips
layer 5	=	16.0 kips	16.1 kips
layer 6	=	16.0 kips	
layer 7	=	16.3 kips	
layer 8	=	16.2 kips	
layer 9	=	16.2 kips	16.3 kips
layer 10	=		16.4 kips
layer 11	=		16.4 kips
layer 12	=		16.4 kips
layer 13	=		16.4 kips
layer 14	=		16.4 kips
Total prestressing force after transfer	$P_1 =$	924.4 kips	933.0 kips

Initial loss =  $(\Delta f_p)/(f_{pi})$

		at midspan	at endspan
layer 1	% =	12.8%	12.1%
layer 2	% =	11.6%	11.0%
layer 3	% =	10.9%	10.3%
layer 4	% =	10.6%	10.1%
layer 5	% =	10.6%	10.1%
layer 6	% =	10.5%	
layer 7	% =	10.2%	
layer 8	% =	10.3%	
layer 9	% =	10.3%	9.8%
layer 10	% =		9.4%
layer 11	% =		9.4%
layer 12	% =		9.4%
layer 13	% =		9.4%
layer 14	% =		9.4%

OK  
OK  
OK  
OK  
OK  
OK  
OK  
OK  
OK  
OK  
OK  
OK  
OK  
OK

**TOTAL LOSSES AT SERVICE LOADS**

Total Losses		at midspan	at endspan
layer 1	$\Delta f_{pT} =$	53.8 ksi	52.7 ksi
layer 2	$\Delta f_{pT} =$	54.2 ksi	53.1 ksi
layer 3	$\Delta f_{pT} =$	54.2 ksi	53.1 ksi
layer 4	$\Delta f_{pT} =$	54.2 ksi	53.1 ksi
layer 5	$\Delta f_{pT} =$	54.2 ksi	53.1 ksi
layer 6	$\Delta f_{pT} =$	54.0 ksi	
layer 7	$\Delta f_{pT} =$	53.6 ksi	
layer 8	$\Delta f_{pT} =$	53.8 ksi	
layer 9	$\Delta f_{pT} =$	53.8 ksi	52.7 ksi
layer 10	$\Delta f_{pT} =$		51.7 ksi
layer 11	$\Delta f_{pT} =$		51.7 ksi
layer 12	$\Delta f_{pT} =$		51.7 ksi
layer 13	$\Delta f_{pT} =$		51.7 ksi
layer 14	$\Delta f_{pT} =$		51.7 ksi

Stress in tendon after all losses =  $f_{pi} - \Delta f_{pt}$

		at midspan	at endspan
layer 1	$f_{pe} =$	118.9 ksi	119.9 ksi
layer 2	$f_{pe} =$	139.8 ksi	140.8 ksi
layer 3	$f_{pe} =$	152.5 ksi	153.6 ksi
layer 4	$f_{pe} =$	156.8 ksi	157.9 ksi
layer 5	$f_{pe} =$	156.8 ksi	157.9 ksi
layer 6	$f_{pe} =$	157.0 ksi	
layer 7	$f_{pe} =$	159.6 ksi	
layer 8	$f_{pe} =$	159.4 ksi	
layer 9	$f_{pe} =$	159.4 ksi	160.4 ksi
layer 10	$f_{pe} =$		161.4 ksi
layer 11	$f_{pe} =$		161.4 ksi
layer 12	$f_{pe} =$		161.4 ksi
layer 13	$f_{pe} =$		161.4 ksi
layer 14	$f_{pe} =$		161.4 ksi

check prestressing stress limit at service limit state:  $f_{pe} \leq 0.8 \cdot f_{py}$

layer 1	=	162.3 ksi
layer 2	=	178.7 ksi
layer 3	=	189.0 ksi
layer 4	=	195.2 ksi
layer 5	=	195.2 ksi
layer 6	=	197.2 ksi
layer 7	=	197.2 ksi
layer 8	=	199.3 ksi
layer 9	=	199.3 ksi
layer 10	=	205.4 ksi
layer 11	=	205.4 ksi
layer 12	=	205.4 ksi
layer 13	=	205.4 ksi
layer 14	=	205.4 ksi

OK  
OK  
OK  
OK  
OK  
OK  
OK  
OK  
OK  
OK  
OK  
OK  
OK  
OK

force per strand =  $f_{pe}$  \* strand area

		at midspan	at endspan
layer 1	=	10.1 kips	10.2 kips
layer 2	=	11.9 kips	12.0 kips
layer 3	=	13.0 kips	13.1 kips
layer 4	=	13.3 kips	13.4 kips
layer 5	=	13.3 kips	13.4 kips
layer 6	=	13.3 kips	
layer 7	=	13.6 kips	
layer 8	=	13.5 kips	
layer 9	=	13.5 kips	13.6 kips
layer 10	=		13.7 kips
layer 11	=		13.7 kips
layer 12	=		13.7 kips
layer 13	=		13.7 kips
layer 14	=		13.7 kips

		at midspan	at endspan
Total prestressing force after all losses	$P_{pe}$ =	783.9 kips	791.8 kips

Final losses, % =  $(\Delta f_{pr}) / (f_{pi})$

layer 1	% =	31.2%	30.5%
layer 2	% =	31.4%	30.8%
layer 3	% =	31.4%	30.8%
layer 4	% =	31.4%	30.8%
layer 5	% =	31.4%	30.8%
layer 6	% =	31.3%	
layer 7	% =	31.0%	
layer 8	% =	31.2%	
layer 9	% =	31.2%	30.5%
layer 10	% =		30.0%
layer 11	% =		30.0%
layer 12	% =		30.0%
layer 13	% =		30.0%
layer 14	% =		30.0%
Average final losses, %	% =	31.3%	30.4%

### Stresses at Transfer

#### STRESS LIMITS FOR CONCRETE

Compression = $0.6f_{ci}$	$f_{ci}$ =	3.300 ksi
Tension		
without bonded reinforcement = $-0.0948 \sqrt{f_{ci}} \leq -0.2$	=	-0.200 ksi
with bonded auxiliary reinforcement = $-0.22 \sqrt{f_{ci}}$	=	-0.016 ksi

#### STRESSES AT TRANSFER LENGTH SECTION

Transfer Length = $60 \times$ (strand diameter)	=	1.9 ft	} Calcs for eccentricity (see 9.6.7.2)
Bending moment at transfer length	$M_g$ =	87.7 ft-kips	
center of 12 strands to top fiber of beam at the end	=	7.00 in	
center of 12 strands to bottom fiber of beam at the harp point	=	11.00 in	
center of 12 strands and top fiber of beam at transfer length	=	9.84 in	
center of gravity of 32 strands and bottom fiber of beam	=	3.98 in	
center of gravity of all strands and the bottom fiber of beam at transfer length	=	15.24 in	
center of gravity of all strands and the bottom fiber of beam at the end	=	15.30 in	
Eccentricity of the strand group at transfer length:	$e_n$ =	28.43 in	
Eccentricity at end of beam:	$e$ =	28.37 in	

$$f_t = \frac{P_i}{A} - \frac{P_i e}{S_t} + \frac{M_f}{S_t}$$

$$f_b = \frac{P_i}{A} + \frac{P_i e}{S_b} - \frac{M_f}{S_b}$$

		at midspan	at endspan
Top stress at top fiber of beam	$f_t$ =	-0.431 ksi	-0.435 ksi
Bottom stress at bottom fiber of the beam	$f_b$ =	3.183 ksi	3.183 ksi

OK  
OK

STRESSES AT HARP POINT			
Bending moment due to beam weight at 0.3L	$M_g =$	1188.0 ft-kips	
Top stress at top fiber of beam	$f_t =$	-0.162 ksi	-0.172 ksi
Bottom stress at bottom fiber of the beam	$f_b =$	2.964 ksi	2.652 ksi

OK  
OK

STRESSES AT MIDSPAN			
Bending moment due to beam weight at 0.5L	$M_g =$	1414.3 ft-kips	
Top stress at top fiber of beam	$f_t =$	-0.091 ksi	0.004 ksi
Bottom stress at bottom fiber of the beam	$f_b =$	2.782 ksi	2.470 ksi

OK  
OK

#### HOLD-DOWN FORCES

assume stress in strand before losses =  $0.8f_u$

layer 1	=	184.2 ksi
layer 2	=	206.9 ksi
layer 3	=	220.5 ksi
layer 4	=	225.1 ksi
layer 5	=	225.1 ksi
layer 6	=	225.1 ksi
layer 7	=	227.4 ksi
layer 8	=	227.4 ksi
layer 9	=	227.4 ksi
layer 10	=	227.4 ksi
layer 11	=	227.4 ksi
layer 12	=	227.4 ksi
layer 13	=	227.4 ksi
layer 14	=	227.4 ksi

prestress force per strand before any losses:

layer 1	=	15.7 kips
layer 2	=	17.6 kips
layer 3	=	18.7 kips
layer 4	=	19.1 kips
layer 5	=	19.1 kips
layer 6	=	19.1 kips
layer 7	=	19.3 kips
layer 8	=	19.3 kips
layer 9	=	19.3 kips
layer 10	=	19.3 kips
layer 11	=	19.3 kips
layer 12	=	19.3 kips
layer 13	=	19.3 kips
layer 14	=	19.3 kips
Harp Angle	$\psi =$	7.2 °

Hold-down force/strand

layer 1	=	2.1 kips/strand
layer 2	=	2.3 kips/strand
layer 3	=	2.5 kips/strand
layer 4	=	2.5 kips/strand
layer 5	=	2.5 kips/strand
layer 6	=	2.5 kips/strand
layer 7	=	2.5 kips/strand
layer 8	=	2.5 kips/strand
layer 9	=	2.5 kips/strand
layer 10	=	2.5 kips/strand
layer 11	=	2.5 kips/strand
layer 12	=	2.5 kips/strand
layer 13	=	2.5 kips/strand
layer 14	=	2.5 kips/strand
Total hold-down force	=	30.15 kips



### Stresses at Service Loads

#### STRESS LIMITS FOR CONCRETE

##### Compression:

Due to permanent loads for load combination Service I

for the precast beam	=	2.777 ksi
for deck	=	1.800 ksi

Due to permanent and transient loads for load combination Service I

for the precast beam	=	3.702 ksi
for deck	=	2.400 ksi

##### Tension:

Load Combination Service III

for the precast beam	=	-0.015 ksi
----------------------	---	------------

#### STRESSES AT MIDSPAN

Compression stresses at top fiber of beam	at midspan	at endspan		
$f_t = \frac{P_{ps}}{A} - \frac{P_{ps}e}{S_t} + \frac{(M_w + M_d)}{S_t} + \frac{(M_w + M_b)}{S_{tw}}$				
Due to permanent loads	$f_{t0} =$	1.858 ksi	1.848 ksi	OK
$f_{t1} = \frac{P_{ps}}{A} - \frac{P_{ps}e}{S_t} + \frac{(M_w + M_d)}{S_t} + \frac{(M_w - M_b)}{S_{tw}} + \frac{(M_{LL+1})}{S_{tw}}$				
Due to permanent loads and transient loads	$f_{t1} =$	2.298 ksi	2.288 ksi	OK
Compression stresses at top fiber of deck	at midspan	at endspan		
$f_{bc} = \frac{(M_w + M_d)}{S_x}$				
Due to permanent loads	$f_{bc} =$	0.054 ksi	0.054 ksi	OK
$f_{bc} = \frac{(M_w + M_d + M_{LL+1})}{S_x}$				
Due to permanent loads and transient loads	$f_{bc} =$	0.627 ksi	0.627 ksi	OK
Tension stresses at top fiber of deck	at midspan	at endspan		
$f_{t2} = \frac{P_{ps}}{A} - \frac{P_{ps}e}{S_t} - \frac{(M_w + M_d)}{S_b} - \frac{(M_w + M_b - 3.8 * M_{LL+1})}{S_{tw}}$				
Load Combination Service III	$f_{t0} =$	-1.589 ksi	-1.558 ksi	OK

### Strength Limit State

#### POSITIVE MOMENT SECTION

$M_u = 1.25DC + 1.5DW + 1.75(LL+IM)$	$M_u =$	8381.5 ft-kips
--------------------------------------	---------	----------------

effective length factor for compression members

layer 1	k =	0.32
layer 2	k =	0.35
layer 3	k =	0.37
layer 4	k =	0.35
layer 5	k =	0.35
layer 6	k =	0.33
layer 7	k =	0.35
layer 8	k =	0.33
layer 9	k =	0.33
layer 10	k =	0.27
layer 11	k =	0.27
layer 12	k =	0.27
layer 13	k =	0.27
layer 14	k =	0.27
c =		4.3 ft-kips

average stress in prestressing steel

layer 1	$f_{ps} =$	226.0 ksi
layer 2	$f_{ps} =$	253.9 ksi
layer 3	$f_{ps} =$	270.6 ksi
layer 4	$f_{ps} =$	276.2 ksi
layer 5	$f_{ps} =$	276.2 ksi
layer 6	$f_{ps} =$	276.2 ksi
layer 7	$f_{ps} =$	279.0 ksi
layer 8	$f_{ps} =$	279.0 ksi
layer 9	$f_{ps} =$	279.0 ksi
layer 10	$f_{ps} =$	279.0 ksi
layer 11	$f_{ps} =$	279.0 ksi
layer 12	$f_{ps} =$	279.0 ksi
layer 13	$f_{ps} =$	279.0 ksi
layer 14	$f_{ps} =$	279.0 ksi

nominal flexure resistance

$a =$	3.65 in
$M_r = \Phi M_n, \Phi = 1.00$	$\Phi M_n =$ 8530.6 ft-kips
$M = DC+W+LL+IM$	$M =$ 5833.6 ft-kips

OK  
OK

**NEGATIVE MOMENT SECTION**

$M_u = 1.25DC+1.5DW+1.75(LL+IM)$	$M_u =$ 4837.2 ft-kips
$a =$	6.50 in
$\Phi M_n =$	4853.4 ft-kips
$M = DC+W+LL+IM$	$M =$ 2869.7 ft-kips

OK  
OK

**Shear Design**

**CRITICAL SECTION AT 0.59**

$V_u = 1.25DC+1.5DW+1.75(LL+IM)$	$V_u =$ 405.0 kips
$M_u = 1.25DC+1.5DW+1.75(LL+IM)$	$M_u =$ -2684.4 ft-kips
or	
$V_u = 1.25DC+1.5DW+1.75(LL+IM)$	$V_u =$ 364.8 kips
$M_u = 1.25DC+1.5DW+1.75(LL+IM)$	$M_u =$ -2877.0 ft-kips
max shear	$V_u =$ 405.0 kips
max moment	$M_u =$ 2877.0 ft-kips
Shear depth	$d_v =$ 73.19 in
Applied factored normal force at the section	$N_u =$ 0
Angle of diagonal compressive stresses	$\theta =$ 36.00 °

**STRAIN IN FLEXURAL TENSION REINFORCEMENT**

$$\epsilon_s = \frac{\frac{M_u}{\phi_s} + 0.5A_s' + 0.5A_s' \cot \theta + A_{ps} f_{ps}}{E_s A_s + E_s A_s'} \leq 0.002$$

resultant compressive stress at centroid

$f_{dc} =$	at midspan	at endspan
	0.515 ksi	0.517 ksi

effective stress in prestressing strand after all losses

layer 1	$f_{po} =$	121.8 ksi	122.9 ksi
layer 2	$f_{po} =$	142.7 ksi	143.8 ksi
layer 3	$f_{po} =$	155.5 ksi	156.6 ksi
layer 4	$f_{po} =$	159.8 ksi	160.9 ksi
layer 5	$f_{po} =$	159.8 ksi	
layer 6	$f_{po} =$	160.0 ksi	
layer 7	$f_{po} =$	162.5 ksi	
layer 8	$f_{po} =$	162.3 ksi	
layer 9	$f_{po} =$		163.4 ksi
layer 10	$f_{po} =$		164.2 ksi
layer 11	$f_{po} =$		164.2 ksi
layer 12	$f_{po} =$		164.2 ksi
layer 13	$f_{po} =$		164.2 ksi
layer 14	$f_{po} =$		164.2 ksi

strain in flexural tension

		at midspan	at endspan
layer 1	$\epsilon_x =$	0.002000	0.002000
layer 2	$\epsilon_x =$	0.002000	0.002000
layer 3	$\epsilon_x =$	0.002000	0.002000
layer 4	$\epsilon_x =$	0.002000	0.002000
layer 5	$\epsilon_x =$	0.002000	
layer 6	$\epsilon_x =$	0.002000	
layer 7	$\epsilon_x =$	0.002000	
layer 8	$\epsilon_x =$	0.002000	
layer 9	$\epsilon_x =$		0.002000
layer 10	$\epsilon_x =$		0.002000
layer 11	$\epsilon_x =$		0.002000
layer 12	$\epsilon_x =$		0.002000
layer 13	$\epsilon_x =$		0.002000
layer 14	$\epsilon_x =$		0.002000

### Deflection and Camber

		at midspan	at endspan
Deflection due to Prestressing Force at Transfer	$\Delta_p =$	3.27 in	3.29 in
Deflection due to Beam Self-Weight at Transfer	$\Delta_g =$	-2.21 in	
Deflection due to Beam Self-Weight at Erection	$\Delta_{g_1} =$	-2.02 in	
Deflection due to Haunch and Deck	$\Delta_s =$	-3.08 in	
Deflection due to total self weight	$\Delta_{sw} =$	-1.82 in	
Total Deflection at transfer	$\Delta =$	1.07 in	1.09 in
Total Deflection at erection	$\Delta =$	2.16 in	2.20 in
Live load deflection limit = span/800	$=$	-1.80 in	
Deflection due to live load and impact	$\Delta_L =$	-1.23 in	
Deflection due to fire truck	$\Delta_L =$	-2.2876 in	
Total Deflection after fire with fire truck	$\Delta =$	-0.8375 in	

OK

NOT OK

**Location: Fire at Critical Positive Moment Sections**  
**Beam Design: 3/8" Strand**  
**Fire Exposure Status: 3 Hour**

(PCI Bridge Design Manual Section 9.6)

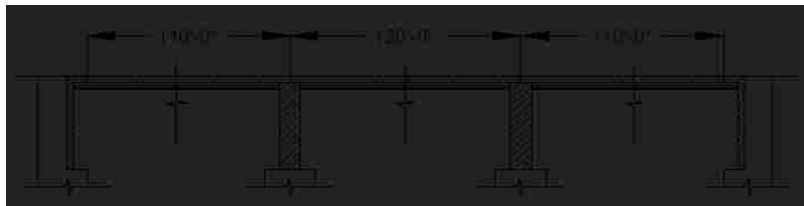


**Material Properties**

CAST-IN-PLACE SLAB			
Actual Thickness	$t_{as} =$		8.0 in
Wearing Surface	$=$		0.5 in
Structural thickness = Actual - Wearing Surface	$t_s =$		7.5 in
Compressive Strength	$f'_c =$		4 ksi
Unit Weight	$w_c =$		150.0 pcf
Stress factor of compression block	$\beta_1 =$		0.85

BEAMS: AASHTO-PCI, BT-72 BULB-TEE			
Strength at release	$f'_{ci} =$		5.5 ksi
Strength at 28 days	$f'_c =$		5.80 ksi
Unit Weight	$w_c =$		150.0 pcf
Overall Beam Length:			
@ end spans	$L =$		110 ft
@ center span	$L =$		119 ft
Design Spans:			
Non-composite beam @ end spans	$L =$		109 ft
Non-composite beam @ center span	$L =$		118 ft
Composite beam @ end spans	$L =$		110 ft
Composite beam @ center span	$L =$		120 ft
Beam Spacing	$S =$		12 ft



**PRESTRESSING STRANDS**

Diameter of single strand	d =	0.375 in
Area of single strand	A =	0.085 in <sup>2</sup>

Temperature of Layer

layer 1 (bottom)	T =	1030.00 °F
layer 2	T =	870.00 °F
layer 3	T =	790.00 °F
layer 4	T =	750.00 °F
layer 5	T =	698.00 °F
layer 6	T =	650.00 °F
layer 7	T =	610.00 °F
layer 8	T =	565.00 °F
layer 9	T =	530.00 °F
layer 10	T =	68.00 °F
layer 11	T =	68.00 °F
layer 12	T =	68.00 °F
layer 13	T =	68.00 °F
layer 14	T =	68.00 °F

Ultimate Strength

initial = 284 ksi

layer 1 (bottom)	f <sub>pu</sub> =	176 ksi
layer 2	f <sub>pu</sub> =	230 ksi
layer 3	f <sub>pu</sub> =	253 ksi
layer 4	f <sub>pu</sub> =	256 ksi
layer 5	f <sub>pu</sub> =	261 ksi
layer 6	f <sub>pu</sub> =	267 ksi
layer 7	f <sub>pu</sub> =	273 ksi
layer 8	f <sub>pu</sub> =	276 ksi
layer 9	f <sub>pu</sub> =	279 ksi
layer 10	f <sub>pu</sub> =	284 ksi
layer 11	f <sub>pu</sub> =	284 ksi
layer 12	f <sub>pu</sub> =	284 ksi
layer 13	f <sub>pu</sub> =	284 ksi
layer 14	f <sub>pu</sub> =	284 ksi

Yield Strength

initial = 257 ksi

layer 1 (bottom)	f <sub>py</sub> =	175 ksi
layer 2	f <sub>py</sub> =	203 ksi
layer 3	f <sub>py</sub> =	213 ksi
layer 4	f <sub>py</sub> =	216 ksi
layer 5	f <sub>py</sub> =	221 ksi
layer 6	f <sub>py</sub> =	229 ksi
layer 7	f <sub>py</sub> =	234 ksi
layer 8	f <sub>py</sub> =	236 ksi
layer 9	f <sub>py</sub> =	239 ksi
layer 10	f <sub>py</sub> =	257 ksi
layer 11	f <sub>py</sub> =	257 ksi
layer 12	f <sub>py</sub> =	257 ksi
layer 13	f <sub>py</sub> =	257 ksi
layer 14	f <sub>py</sub> =	257 ksi

**Stress Limits:**

before transfer ≤ 0.75f<sub>pu</sub> (initial = 202.5)

layer 1 (bottom)	f <sub>pi</sub> =	132.2 ksi
layer 2	f <sub>pi</sub> =	172.7 ksi
layer 3	f <sub>pi</sub> =	189.7 ksi
layer 4	f <sub>pi</sub> =	191.8 ksi
layer 5	f <sub>pi</sub> =	196.1 ksi
layer 6	f <sub>pi</sub> =	200.4 ksi
layer 7	f <sub>pi</sub> =	204.6 ksi
layer 8	f <sub>pi</sub> =	206.8 ksi
layer 9	f <sub>pi</sub> =	208.9 ksi
layer 10	f <sub>pi</sub> =	213.2 ksi
layer 11	f <sub>pi</sub> =	213.2 ksi
layer 12	f <sub>pi</sub> =	213.2 ksi
layer 13	f <sub>pi</sub> =	213.2 ksi
layer 14	f <sub>pi</sub> =	213.2 ksi



**COMPOSITE BEAM AT MIDSPAN**

Effective Flange Width	$b_f =$	111.0 in	*min of three criteria
Modular Ratio = $E_{cs}/E_c$	$n =$	0.8305	
Transformed flange width	$=$	92.2 in	
Transformed flange area	$=$	691.4 in <sup>2</sup>	
Transformed haunch width	$=$	34.9 in	
Transformed haunch area	$=$	17.4 in <sup>2</sup>	

	Transformed Area	$y_b$	$Ay_b$	$A(y_{bc}-y_b)^2$	I	$I + A(y_{bc}-y_b)^2$
Beam	767.0 in <sup>2</sup>	50.74 in	38,917.6 in <sup>3</sup>	114,248 in <sup>4</sup>	322,319 in <sup>4</sup>	436,566 in <sup>4</sup>
Haunch	17.4 in <sup>2</sup>	72.25 in	1,260.0 in <sup>3</sup>	1,510 in <sup>4</sup>	0.33 in <sup>4</sup>	1,510 in <sup>4</sup>
Deck	691.4 in <sup>2</sup>	76.25 in	52,715.7 in <sup>3</sup>	122,392 in <sup>4</sup>	2,950 in <sup>4</sup>	125,341 in <sup>4</sup>
Total	1475.8 in <sup>2</sup>		92,893.3 in <sup>3</sup>			563,418 in <sup>4</sup>

Total area of Composite Section	$A_c =$	1476 in <sup>2</sup>
Overall Depth of the Composite Section	$h_c =$	80 in
Moment of Inertia	$I_c =$	563,418 in <sup>4</sup>
Distance from centroid to extreme <u>bottom</u> fiber of beam	$y_{bc} =$	62.94 in
Distance from centroid to extreme <u>top</u> fiber of beam	$y_{tg} =$	9.06 in
Distance from centroid to extreme <u>top</u> fiber of slab	$y_{lc} =$	17.06 in
Section modulus for the extreme <u>bottom</u> fiber of beam	$S_{bc} =$	8,951.0 in <sup>3</sup>
Section modulus for the extreme <u>top</u> fiber of beam	$S_{tg} =$	62,219.4 in <sup>3</sup>
Section modulus for the extreme <u>top</u> fiber slab	$S_{lc} =$	39,779.1 in <sup>3</sup>

**Shear Forces and Bending Moments**

**DEAD LOADS**

Beam self-weight	$w_{beam} =$	0.799 k/f
8 in. deck weight	$w_{deck} =$	1.200 k/f
1/2 in. haunch weight	$w_{haunch} =$	0.022 k/f

LRFD Specifications: Art. 4.6.2.2.1

Width of Deck Constant		OK
Number of beams is not less than four $N_b =$	4	OK
Roadway part of the overhang, $d_o \leq 3.0$ ft, $d_e =$	1.5	OK
Curvature in plans is less than $4^\circ =$	0	OK
Cross-section of the bridge is consistent with one of the cross sections given by LRFD specs		OK

Barrier and wearing surface loads are equally distributed among the 4 beams

Barrier Wt	$Wt =$	0.150 k/f
Dead load of future wearing surface	$DW =$	0.263 k/f

**LIVE LOADS**

Fire truck live load front load (Point A)	$P_{live} =$	48.0 kips
Fire truck live load back load (Point B)	$P_{live} =$	22.0 kips
distance between two loads		19.2 ft
distance from nearest edge to point A	$x_a =$	59.0 ft
distance from nearest edge to point B	$x_b =$	39.8 ft

LRFD Specifications: Art. 4.6.2.2.1

Width of Deck Constant		OK
Number of beams is not less than four $N_b =$	4	OK
Beams are parallel and approximately of the same stiffness		OK
Roadway part of the overhang, $d_o \leq 3.0$ ft, $d_e =$	1.5	OK
Curvature in plans is less than $4^\circ =$	0	OK

Barrier and wearing surface loads are equally distributed among the 4 beams

Bridge Type-- "k" (LRFD Table 4.6.2.2.1-1)

Number of design lanes = $w/12$	$=$	3 lanes
---------------------------------	-----	---------

**Distribution Factor for Bending Moment:**

Beams spacing	S =	12.0 ft
Depth of concrete slab	t <sub>s</sub> =	7.5 in
Beam Span	L =	120.0 ft
Number of Beams	N <sub>b</sub> =	4
Modular ratio between beam & deck materials	n =	1.2042
Longitudinal stiffness parameter	K <sub>y</sub> =	1,840,120.45 in <sup>4</sup>

at center span:

$$DFM = 0.75 + \left(\frac{S}{9.5}\right)^{0.4} * \left(\frac{S}{L}\right)^{0.3} * \left(\frac{K_y}{12 * L * t_s^3}\right)^{0.1}$$

DFM =	0.886 lanes/beam
-------	------------------

one design lane loaded:

$$DFM = 0.75 + \left(\frac{S}{14}\right)^{0.4} * \left(\frac{S}{L}\right)^{0.3} * \left(\frac{K_y}{12 * L * t_s^3}\right)^{0.1}$$

DFM =	0.601 lanes/beam
-------	------------------

0.905 Controls

**Distribution Factor for Shear Force**

both end spans and center span:

$$DFV = 0.2 + \left(\frac{S'}{12}\right) - \left(\frac{S'}{35}\right)^2$$

DFV =	1.082 lanes/beam
-------	------------------

one design lane loaded:

$$DFV = 0.36 + \left(\frac{S'}{25}\right)$$

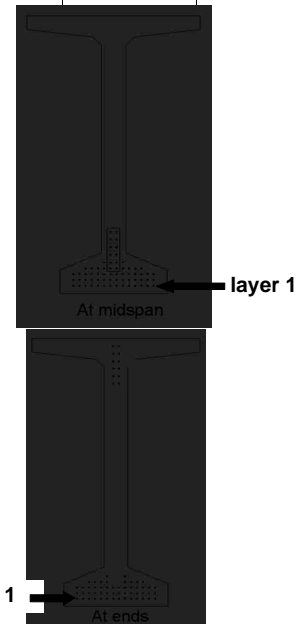
DFV =	0.840 lanes/beam
-------	------------------

1.082 Controls

from bottom	At Midspan		At Ends	
	No. of	Distance from Bottom	No. of	Distance from Bottom
layer 1	14	2	14	2
layer 2	14	3.5	14	3.5
layer 3	14	5	14	5
layer 4	10	6.5	8	6.5
layer 5	4	8	2	8
layer 6	2	10	-	-
layer 7	2	12	-	-
layer 8	2	14	-	-
layer 9	2	16	2	60
layer 10	-	-	2	62
layer 11	-	-	2	64
layer 12	-	-	2	66
layer 13	-	-	2	68
layer 14	-	-	2	70
	64		64	
<b>Harped Strand Group (included in above totals)</b>				
layer 3	2	6		
layer 4	2	8		
layer 5	2	10		
layer 6	2	12		
layer 7	2	14		
layer 8	2	16		

distance from the center of gravity of strands to the bottom fiber of the beam = 7% of the beam depth  
strand eccentricity at midspan = (y<sub>c</sub> - y<sub>bs</sub>)

y <sub>bs</sub> =	5.44 in
e <sub>c</sub> =	45.30 in





## Prestress Losses

### ELASTIC SHORTENING

assumed loss	=	6.00%
Force per strand at transfer		
layer 1	=	10.6 kips
layer 2	=	13.8 kips
layer 3	=	15.2 kips
layer 4	=	15.3 kips
layer 5	=	15.7 kips
layer 6	=	16.0 kips
layer 7	=	16.3 kips
layer 8	=	16.5 kips
layer 9	=	16.7 kips
layer 10	=	17.0 kips
layer 11	=	17.0 kips
layer 12	=	17.0 kips
layer 13	=	17.0 kips
layer 14	=	17.0 kips

Total prestressing force at release	$P_i =$	at midspan 901.2 kips	at endspan 880.2 kips
Sum of concrete stresses at the center of gravity of prestressing tendons due to prestressing force at transfer and the self-weight of the member at sections of maximum moment	$f_{cgp} =$	4.568 ksi	4.407 ksi
Loss due to shortening			
		at midspan	at endspan
layer 1	$\Delta f_{pES} =$	26.3 ksi	25.4 ksi
layer 2	$\Delta f_{pES} =$	27.6 ksi	26.7 ksi
layer 3	$\Delta f_{pES} =$	28.2 ksi	27.2 ksi
layer 4	$\Delta f_{pES} =$	28.2 ksi	27.2 ksi
layer 5	$\Delta f_{pES} =$	28.2 ksi	27.2 ksi
layer 6	$\Delta f_{pES} =$	28.2 ksi	
layer 7	$\Delta f_{pES} =$	28.2 ksi	
layer 8	$\Delta f_{pES} =$	28.2 ksi	
layer 9	$\Delta f_{pES} =$	28.2 ksi	27.2 ksi
layer 10	$\Delta f_{pES} =$		25.4 ksi
layer 11	$\Delta f_{pES} =$		25.4 ksi
layer 12	$\Delta f_{pES} =$		25.4 ksi
layer 13	$\Delta f_{pES} =$		25.4 ksi
layer 14	$\Delta f_{pES} =$		25.4 ksi

### SHRINKAGE

Shrinkage = $(17 - 0.15 \cdot \text{Relative Humidity})$	$\Delta f_{pSR} =$	6.5 ksi	← assume relative humidity = 70%
--	--------------------	---------	----------------------------------

### CREEP OF CONCRETE

Change of stresses at center of gravity of prestressing due to permanent loads except the loads acting at time of applying prestressing force, calculated at the same section as $f_{cgp}$	$\Delta f_{cgp} =$	3.833 ksi	
loss due to creep	$\Delta f_{pCR} =$	at midspan 28.0 ksi	at endspan 26.0 ksi

**RELAXATION OF PRESTRESSING STRANDS**

loss due to relaxation after transfer		at midspan	at endspan
layer 1	$\Delta f_{pR2} =$	0.8 ksi	0.9 ksi
layer 2	$\Delta f_{pR2} =$	0.6 ksi	0.7 ksi
layer 3	$\Delta f_{pR2} =$	0.6 ksi	0.7 ksi
layer 4	$\Delta f_{pR2} =$	0.6 ksi	0.7 ksi
layer 5	$\Delta f_{pR2} =$	0.6 ksi	0.7 ksi
layer 6	$\Delta f_{pR2} =$	0.6 ksi	
layer 7	$\Delta f_{pR2} =$	0.6 ksi	
layer 8	$\Delta f_{pR2} =$	0.6 ksi	
layer 9	$\Delta f_{pR2} =$	0.6 ksi	0.7 ksi
layer 10	$\Delta f_{pR2} =$		0.9 ksi
layer 11	$\Delta f_{pR2} =$		0.9 ksi
layer 12	$\Delta f_{pR2} =$		0.9 ksi
layer 13	$\Delta f_{pR2} =$		0.9 ksi
layer 14	$\Delta f_{pR2} =$		0.9 ksi

**TOTAL LOSSES AT TRANSFER**

total loss  $\Delta f_{pES} = \Delta f_{pt}$

stress in tendons after transfer  $f_{pt} = f_{pr} - \Delta f_{pt}$

		at midspan	at endspan
layer 1	$f_{pt} =$	105.8 ksi	106.8 ksi
layer 2	$f_{pt} =$	145.0 ksi	146.0 ksi
layer 3	$f_{pt} =$	161.6 ksi	162.5 ksi
layer 4	$f_{pt} =$	163.7 ksi	164.7 ksi
layer 5	$f_{pt} =$	167.9 ksi	168.9 ksi
layer 6	$f_{pt} =$	172.2 ksi	
layer 7	$f_{pt} =$	176.5 ksi	
layer 8	$f_{pt} =$	178.6 ksi	
layer 9	$f_{pt} =$	180.7 ksi	181.7 ksi
layer 10	$f_{pt} =$		187.8 ksi
layer 11	$f_{pt} =$		187.8 ksi
layer 12	$f_{pt} =$		187.8 ksi
layer 13	$f_{pt} =$		187.8 ksi
layer 14	$f_{pt} =$		187.8 ksi

force per strand =  $f_{pt} \cdot \text{strand area}$

		at midspan	at endspan
layer 1	=	9.0 kips	9.1 kips
layer 2	=	12.3 kips	12.4 kips
layer 3	=	13.7 kips	13.8 kips
layer 4	=	13.9 kips	14.0 kips
layer 5	=	14.3 kips	14.4 kips
layer 6	=	14.6 kips	
layer 7	=	15.0 kips	
layer 8	=	15.2 kips	
layer 9	=	15.4 kips	15.4 kips
layer 10	=		16.0 kips
layer 11	=		16.0 kips
layer 12	=		16.0 kips
layer 13	=		16.0 kips
layer 14	=		16.0 kips
Total prestressing force after transfer	$P_i =$	775.8 kips	797.0 kips

Initial loss =  $(\Delta f_p)/(f_{pi})$

		at midspan	at endspan
layer 1	% =	19.9%	19.2%
layer 2	% =	16.0%	15.4%
layer 3	% =	14.8%	14.3%
layer 4	% =	14.7%	14.2%
layer 5	% =	14.4%	13.8%
layer 6	% =	14.1%	
layer 7	% =	13.8%	
layer 8	% =	13.6%	
layer 9	% =	13.5%	13.0%
layer 10	% =		11.9%
layer 11	% =		11.9%
layer 12	% =		11.9%
layer 13	% =		11.9%
layer 14	% =		11.9%

OK  
OK  
OK  
OK  
OK  
OK  
OK  
OK  
OK  
OK  
OK  
OK  
OK

**TOTAL LOSSES AT SERVICE LOADS**

Total Losses		at midspan	at endspan
layer 1	$\Delta f_{pT} =$	61.6 ksi	60.6 ksi
layer 2	$\Delta f_{pT} =$	62.9 ksi	61.9 ksi
layer 3	$\Delta f_{pT} =$	63.4 ksi	62.4 ksi
layer 4	$\Delta f_{pT} =$	63.4 ksi	62.4 ksi
layer 5	$\Delta f_{pT} =$	63.4 ksi	62.4 ksi
layer 6	$\Delta f_{pT} =$	63.4 ksi	
layer 7	$\Delta f_{pT} =$	63.4 ksi	
layer 8	$\Delta f_{pT} =$	63.4 ksi	
layer 9	$\Delta f_{pT} =$	63.4 ksi	62.4 ksi
layer 10	$\Delta f_{pT} =$		60.6 ksi
layer 11	$\Delta f_{pT} =$		60.6 ksi
layer 12	$\Delta f_{pT} =$		60.6 ksi
layer 13	$\Delta f_{pT} =$		60.6 ksi
layer 14	$\Delta f_{pT} =$		60.6 ksi

Stress in tendon after all losses =  $f_{pi} - \Delta f_{pT}$

		at midspan	at endspan
layer 1	$f_{pe} =$	70.6 ksi	71.5 ksi
layer 2	$f_{pe} =$	109.8 ksi	110.7 ksi
layer 3	$f_{pe} =$	126.3 ksi	127.3 ksi
layer 4	$f_{pe} =$	128.4 ksi	129.4 ksi
layer 5	$f_{pe} =$	132.7 ksi	133.7 ksi
layer 6	$f_{pe} =$	137.0 ksi	
layer 7	$f_{pe} =$	141.2 ksi	
layer 8	$f_{pe} =$	143.4 ksi	
layer 9	$f_{pe} =$	145.5 ksi	146.5 ksi
layer 10	$f_{pe} =$		152.5 ksi
layer 11	$f_{pe} =$		152.5 ksi
layer 12	$f_{pe} =$		152.5 ksi
layer 13	$f_{pe} =$		152.5 ksi
layer 14	$f_{pe} =$		152.5 ksi

check prestressing stress limit at service limit state:  $f_{pe} \leq 0.8 \cdot f_{py}$

layer 1	=	139.7 ksi
layer 2	=	162.3 ksi
layer 3	=	170.5 ksi
layer 4	=	172.6 ksi
layer 5	=	176.7 ksi
layer 6	=	182.8 ksi
layer 7	=	187.0 ksi
layer 8	=	189.0 ksi
layer 9	=	191.1 ksi
layer 10	=	205.4 ksi
layer 11	=	205.4 ksi
layer 12	=	205.4 ksi
layer 13	=	205.4 ksi
layer 14	=	205.4 ksi

OK  
OK  
OK  
OK  
OK  
OK  
OK  
OK  
OK  
OK  
OK  
OK  
OK  
OK

force per strand =  $f_{pe}$  \* strand area

		at midspan	at endspan
layer 1	=	6.0 kips	6.1 kips
layer 2	=	9.3 kips	9.4 kips
layer 3	=	10.7 kips	10.8 kips
layer 4	=	10.9 kips	11.0 kips
layer 5	=	11.3 kips	11.4 kips
layer 6	=	11.6 kips	
layer 7	=	12.0 kips	
layer 8	=	12.2 kips	
layer 9	=	12.4 kips	12.5 kips
layer 10	=		13.0 kips
layer 11	=		13.0 kips
layer 12	=		13.0 kips
layer 13	=		13.0 kips
layer 14	=		13.0 kips

Total prestressing force after all losses  $P_{pe}$  =  
 Final losses, % =  $(\Delta f_{pr}) / (f_{pi})$

		at midspan	at endspan
$P_{pe}$ =		615.6 kips	633.7 kips
layer 1	% =	46.6%	45.9%
layer 2	% =	47.6%	46.8%
layer 3	% =	48.0%	47.2%
layer 4	% =	48.0%	47.2%
layer 5	% =	48.0%	47.2%
layer 6	% =	48.0%	
layer 7	% =	48.0%	
layer 8	% =	48.0%	
layer 9	% =	48.0%	47.2%
layer 10	% =		45.9%
layer 11	% =		45.9%
layer 12	% =		45.9%
layer 13	% =		45.9%
layer 14	% =		45.9%
Average final losses, %	% =	47.8%	46.5%

### Stresses at Transfer

#### STRESS LIMITS FOR CONCRETE

Compression = $0.6f_{ci}$	$f_{ci}$ =	3.300 ksi
Tension		
without bonded reinforcement = $-0.0948 \sqrt{f_{ci}} \leq -0.2$	=	-0.200 ksi
with bonded auxiliary reinforcement = $-0.22 \sqrt{f_{ci}}$	=	-0.016 ksi

#### STRESSES AT TRANSFER LENGTH SECTION

Transfer Length = $60 \times$ (strand diameter)	=	1.9 ft	} Calcs for eccentricity (see 9.6.7.2)
Bending moment at transfer length	$M_g$ =	87.7 ft-kips	
center of 12 strands to top fiber of beam at the end	=	7.00 in	
center of 12 strands to bottom fiber of beam at the harp point	=	11.00 in	
center of 12 strands and top fiber of beam at transfer length	=	9.84 in	
center of gravity of 32 strands and bottom fiber of beam	=	3.98 in	
center of gravity of all strands and the bottom fiber of beam at transfer length	=	15.24 in	
center of gravity of all strands and the bottom fiber of beam at the end	=	15.30 in	
Eccentricity of the strand group at transfer length:	$e_n$ =	35.50 in	
Eccentricity at end of beam:	$e$ =	35.44 in	

$$f_t = \frac{P_i}{A} - \frac{P_i e}{S_t} + \frac{M_f}{S_t}$$

$$f_b = \frac{P_i}{A} + \frac{P_i e}{S_b} - \frac{M_f}{S_b}$$

		at midspan	at endspan
Top stress at top fiber of beam	$f_t$ =	-0.706 ksi	-0.727 ksi
Bottom stress at bottom fiber of the beam	$f_b$ =	3.249 ksi	3.249 ksi

OK  
OK

STRESSES AT HARP POINT			
Bending moment due to beam weight at 0.3L	$M_g =$	1188.0 ft-kips	
Top stress at top fiber of beam	$f_t =$	-0.343 ksi	-0.378 ksi
Bottom stress at bottom fiber of the beam	$f_b =$	2.956 ksi	2.504 ksi

OK  
OK

STRESSES AT MIDSPAN			
Bending moment due to beam weight at 0.5L	$M_g =$	1414.3 ft-kips	
Top stress at top fiber of beam	$f_t =$	-0.372 ksi	-0.202 ksi
Bottom stress at bottom fiber of the beam	$f_b =$	2.774 ksi	2.322 ksi

OK  
OK

#### HOLD-DOWN FORCES

assume stress in strand before losses =  $0.8f_u$

layer 1	=	141.0 ksi
layer 2	=	184.2 ksi
layer 3	=	202.4 ksi
layer 4	=	204.6 ksi
layer 5	=	209.2 ksi
layer 6	=	213.7 ksi
layer 7	=	218.3 ksi
layer 8	=	220.5 ksi
layer 9	=	222.8 ksi
layer 10	=	227.4 ksi
layer 11	=	227.4 ksi
layer 12	=	227.4 ksi
layer 13	=	227.4 ksi
layer 14	=	227.4 ksi

prestress force per strand before any losses:

layer 1	=	12.0 kips
layer 2	=	15.7 kips
layer 3	=	17.2 kips
layer 4	=	17.4 kips
layer 5	=	17.8 kips
layer 6	=	18.2 kips
layer 7	=	18.6 kips
layer 8	=	18.7 kips
layer 9	=	18.9 kips
layer 10	=	19.3 kips
layer 11	=	19.3 kips
layer 12	=	19.3 kips
layer 13	=	19.3 kips
layer 14	=	19.3 kips
Harp Angle	$\psi =$	7.2 °

Hold-down force/strand

layer 1	=	1.6 kips/strand
layer 2	=	2.1 kips/strand
layer 3	=	2.3 kips/strand
layer 4	=	2.3 kips/strand
layer 5	=	2.3 kips/strand
layer 6	=	2.4 kips/strand
layer 7	=	2.4 kips/strand
layer 8	=	2.5 kips/strand
layer 9	=	2.5 kips/strand
layer 10	=	2.5 kips/strand
layer 11	=	2.5 kips/strand
layer 12	=	2.5 kips/strand
layer 13	=	2.5 kips/strand
layer 14	=	2.5 kips/strand
Total hold-down force	=	28.32 kips

**Stresses at Service Loads**

**STRESS LIMITS FOR CONCRETE**

**Compression:**

Due to permanent loads for load combination Service I

for the precast beam	=	2.610 ksi
for deck	=	1.800 ksi

Due to permanent and transient loads for load combination Service I

for the precast beam	=	3.480 ksi
for deck	=	2.400 ksi

**Tension:**

Load Combination Service III

for the precast beam	=	-0.014 ksi
----------------------	---	------------

**STRESSES AT MIDSPAN**

Compression stresses at top fiber of beam	at midspan	at endspan
$f_t = \frac{P_{ps}}{A} - \frac{P_{ps}e}{S_t} + \frac{(M_w + M_d)}{S_t} + \frac{(M_w + M_d)}{S_{yt}}$		
Due to permanent loads	$f_{t0} =$	1.770 ksi
		1.741 ksi
$f_{ty} = \frac{P_{ps}}{A} - \frac{P_{ps}e}{S_t} + \frac{(M_w + M_d)}{S_t} + \frac{(M_w + M_d)}{S_{yt}} + \frac{(M_{LL1})}{S_{yt}}$		
Due to permanent loads and transient loads	$f_{ty} =$	2.178 ksi
		2.149 ksi
Compression stresses at top fiber of deck	at midspan	at endspan
$f_{ts} = \frac{(M_w + M_d)}{S_{ts}}$		
Due to permanent loads	$f_{t0} =$	0.061 ksi
		0.061 ksi
$f_{ty} = \frac{(M_w + M_d + M_{LL1})}{S_{ts}}$		
Due to permanent loads and transient loads	$f_{ty} =$	0.699 ksi
		0.699 ksi
Tension stresses at top fiber of deck	at midspan	at endspan
$f_{ty} = \frac{P_{ps}}{A} + \frac{P_{ps}e}{S_b} - \frac{(M_w + M_d)}{S_b} - \frac{(M_w + M_d + 0.8 * M_{LL1})}{S_b}$		
Load Combination Service III	$f_{t0} =$	-2.695 ksi
		-2.617 ksi

OK

OK

OK

OK

OK

**Strength Limit State**

**POSITIVE MOMENT SECTION**

$M_u = 1.25DC + 1.5DW + 1.75(LL+IM)$	$M_u =$	8381.5 ft-kips
--------------------------------------	---------	----------------

effective length factor for compression members

layer 1	k =	0.10
layer 2	k =	0.32
layer 3	k =	0.39
layer 4	k =	0.39
layer 5	k =	0.39
layer 6	k =	0.37
layer 7	k =	0.37
layer 8	k =	0.37
layer 9	k =	0.37
layer 10	k =	0.27
layer 11	k =	0.27
layer 12	k =	0.27
layer 13	k =	0.27
layer 14	k =	0.27
c =		3.8 ft-kips

average stress in prestressing steel

layer 1	$f_{ps} =$	175.3 ksi
layer 2	$f_{ps} =$	229.0 ksi
layer 3	$f_{ps} =$	251.7 ksi
layer 4	$f_{ps} =$	254.5 ksi
layer 5	$f_{ps} =$	260.2 ksi
layer 6	$f_{ps} =$	265.8 ksi
layer 7	$f_{ps} =$	271.5 ksi
layer 8	$f_{ps} =$	274.3 ksi
layer 9	$f_{ps} =$	277.1 ksi
layer 10	$f_{ps} =$	282.8 ksi
layer 11	$f_{ps} =$	282.8 ksi
layer 12	$f_{ps} =$	282.8 ksi
layer 13	$f_{ps} =$	282.8 ksi
layer 14	$f_{ps} =$	282.8 ksi

nominal flexure resistance

$a =$	3.24 in
$M_r = \Phi M_n, \Phi = 1.00$	$\Phi M_n =$ 7682.2 ft-kips
$M = DC+W+LL+IM$	$M =$ 5833.6 ft-kips

NOT OK  
OK

**NEGATIVE MOMENT SECTION**

$M_u = 1.25DC+1.5DW+1.75(LL+IM)$	$M_u =$ 4837.2 ft-kips
$a =$	6.92 in
$\Phi M_n =$	4839.6 ft-kips
$M = DC+W+LL+IM$	$M =$ 2869.7 ft-kips

OK  
OK

**Shear Design**

**CRITICAL SECTION AT 0.59**

$V_u = 1.25DC+1.5DW+1.75(LL+IM)$	$V_u =$ 405.0 kips
$M_u = 1.25DC+1.5DW+1.75(LL+IM)$	$M_u =$ -2684.4 ft-kips
or	
$V_u = 1.25DC+1.5DW+1.75(LL+IM)$	$V_u =$ 364.8 kips
$M_u = 1.25DC+1.5DW+1.75(LL+IM)$	$M_u =$ -2877.0 ft-kips
max shear	$V_u =$ 405.0 kips
max moment	$M_u =$ 2877.0 ft-kips
Shear depth	$d_v =$ 73.19 in
Applied factored normal force at the section	$N_u =$ 0
Angle of diagonal compressive stresses	$\theta =$ 36.00 °

**STRAIN IN FLEXURAL TENSION REINFORCEMENT**

$$\epsilon_s = \frac{\frac{M_u}{d_v} + 0.5A'_s + 0.5V_u \cot \theta}{E_s A_s + E_s A'_s} \leq 0.002$$

resultant compressive stress at centroid

$f_{dc} =$	at midspan	at endspan
	0.348 ksi	0.349 ksi

effective stress in prestressing strand after all losses

layer 1	$f_{po} =$	72.5 ksi	73.5 ksi
layer 2	$f_{po} =$	111.8 ksi	112.8 ksi
layer 3	$f_{po} =$	128.4 ksi	129.4 ksi
layer 4	$f_{po} =$	130.5 ksi	131.5 ksi
layer 5	$f_{po} =$	134.8 ksi	
layer 6	$f_{po} =$	139.0 ksi	
layer 7	$f_{po} =$	143.3 ksi	
layer 8	$f_{po} =$	145.4 ksi	
layer 9	$f_{po} =$		148.6 ksi
layer 10	$f_{po} =$		154.5 ksi
layer 11	$f_{po} =$		154.5 ksi
layer 12	$f_{po} =$		154.5 ksi
layer 13	$f_{po} =$		154.5 ksi
layer 14	$f_{po} =$		154.5 ksi

strain in flexural tension

		at midspan	at endspan
layer 1	$\epsilon_x =$	0.002000	0.002000
layer 2	$\epsilon_x =$	0.002000	0.002000
layer 3	$\epsilon_x =$	0.002000	0.002000
layer 4	$\epsilon_x =$	0.002000	0.002000
layer 5	$\epsilon_x =$	0.002000	
layer 6	$\epsilon_x =$	0.002000	
layer 7	$\epsilon_x =$	0.002000	
layer 8	$\epsilon_x =$	0.002000	
layer 9	$\epsilon_x =$		0.002000
layer 10	$\epsilon_x =$		0.002000
layer 11	$\epsilon_x =$		0.002000
layer 12	$\epsilon_x =$		0.002000
layer 13	$\epsilon_x =$		0.002000
layer 14	$\epsilon_x =$		0.002000

### Deflection and Camber

Deflection due to Prestressing Force at Transfer  
 Deflection due to Beam Self-Weight at Transfer  
 Deflection due to Beam Self-Weight at Erection  
 Deflection due to Haunch and Deck

	at midspan	at endspan
$\Delta_p =$	3.27 in	3.29 in
$\Delta_g =$	-2.49 in	
$\Delta_{gs} =$	-2.34 in	
$\Delta_s =$	-3.58 in	

Deflection due to total self weight

$\Delta_{sw} =$	-2.65 in
-----------------	----------

Total Deflection at transfer

$\Delta =$	0.79 in	0.81 in
------------	---------	---------

Total Deflection at erection

$\Delta =$	1.56 in	1.59 in
------------	---------	---------

Live load deflection limit = span/800

$=$	-1.80 in
-----	----------

Deflection due to live load and impact

$\Delta_L =$	-1.69 in
--------------	----------

OK

Deflection due to fire truck

$\Delta_L =$	-2.6588 in
--------------	------------

NOT OK

Total Deflection after fire with fire truck

$\Delta =$	-2.0358 in
------------	------------



**Location: Fire at Critical Positive Moment Sections**  
**Beam Design: 3/8" Strand**  
**Fire Exposure Status: 4 Hour**

(PCI Bridge Design Manual Section 9.6)

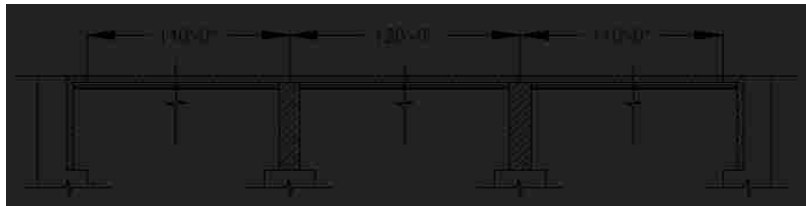


**Material Properties**

CAST-IN-PLACE SLAB			
Actual Thickness	$t_{as} =$		8.0 in
Wearing Surface	$=$		0.5 in
Structural thickness = Actual - Wearing Surface	$t_s =$		7.5 in
Compressive Strength	$f'_c =$		4 ksi
Unit Weight	$w_c =$		150.0 pcf
Stress factor of compression block	$\beta_1 =$		0.85

BEAMS: AASHTO-PCI, BT-72 BULB-TEE			
Strength at release	$f'_{ci} =$		5.5 ksi
Strength at 28 days	$f'_c =$		5.46 ksi
Unit Weight	$w_c =$		150.0 pcf
Overall Beam Length:			
@ end spans	$L =$		110 ft
@ center span	$L =$		119 ft
Design Spans:			
Non-composite beam @ end spans	$L =$		109 ft
Non-composite beam @ center span	$L =$		118 ft
Composite beam @ end spans	$L =$		110 ft
Composite beam @ center span	$L =$		120 ft
Beam Spacing	$S =$		12 ft



**PRESTRESSING STRANDS**

Diameter of single strand	d =	0.375 in
Area of single strand	A =	0.085 in <sup>2</sup>

Temperature of Layer	layer 1 (bottom)	T =	1100.00 °F
	layer 2	T =	980.00 °F
	layer 3	T =	890.00 °F
	layer 4	T =	850.00 °F
	layer 5	T =	800.00 °F
	layer 6	T =	770.00 °F
	layer 7	T =	735.00 °F
	layer 8	T =	700.00 °F
	layer 9	T =	675.00 °F
	layer 10	T =	68.00 °F
	layer 11	T =	68.00 °F
	layer 12	T =	68.00 °F
	layer 13	T =	68.00 °F
	layer 14	T =	68.00 °F

Ultimate Strength initial = 284 ksi	layer 1 (bottom)	f <sub>pu</sub> =	151 ksi
	layer 2	f <sub>pu</sub> =	193 ksi
	layer 3	f <sub>pu</sub> =	225 ksi
	layer 4	f <sub>pu</sub> =	236 ksi
	layer 5	f <sub>pu</sub> =	250 ksi
	layer 6	f <sub>pu</sub> =	256 ksi
	layer 7	f <sub>pu</sub> =	259 ksi
	layer 8	f <sub>pu</sub> =	264 ksi
	layer 9	f <sub>pu</sub> =	267 ksi
	layer 10	f <sub>pu</sub> =	284 ksi
	layer 11	f <sub>pu</sub> =	284 ksi
	layer 12	f <sub>pu</sub> =	284 ksi
	layer 13	f <sub>pu</sub> =	284 ksi
	layer 14	f <sub>pu</sub> =	284 ksi

Yield Strength initial = 257 ksi	layer 1 (bottom)	f <sub>py</sub> =	154 ksi
	layer 2	f <sub>py</sub> =	190 ksi
	layer 3	f <sub>py</sub> =	200 ksi
	layer 4	f <sub>py</sub> =	205 ksi
	layer 5	f <sub>py</sub> =	211 ksi
	layer 6	f <sub>py</sub> =	213 ksi
	layer 7	f <sub>py</sub> =	216 ksi
	layer 8	f <sub>py</sub> =	247 ksi
	layer 9	f <sub>py</sub> =	226 ksi
	layer 10	f <sub>py</sub> =	257 ksi
	layer 11	f <sub>py</sub> =	257 ksi
	layer 12	f <sub>py</sub> =	257 ksi
	layer 13	f <sub>py</sub> =	257 ksi
	layer 14	f <sub>py</sub> =	257 ksi

<b>Stress Limits:</b> before transfer ≤ 0.75f <sub>pu</sub> (initial = 202.5)	layer 1 (bottom)	f <sub>pi</sub> =	113.0 ksi
	layer 2	f <sub>pi</sub> =	144.9 ksi
	layer 3	f <sub>pi</sub> =	168.4 ksi
	layer 4	f <sub>pi</sub> =	176.9 ksi
	layer 5	f <sub>pi</sub> =	187.6 ksi
	layer 6	f <sub>pi</sub> =	191.8 ksi
	layer 7	f <sub>pi</sub> =	194.0 ksi
	layer 8	f <sub>pi</sub> =	198.2 ksi
	layer 9	f <sub>pi</sub> =	200.4 ksi
	layer 10	f <sub>pi</sub> =	213.2 ksi
	layer 11	f <sub>pi</sub> =	213.2 ksi
	layer 12	f <sub>pi</sub> =	213.2 ksi
	layer 13	f <sub>pi</sub> =	213.2 ksi
	layer 14	f <sub>pi</sub> =	213.2 ksi

at service limit state (after all losses)  $\leq 0.80f_{py}$  (initial = 194.4)

layer 1 (bottom)	$f_{pe} =$	123.3 ksi
layer 2	$f_{pe} =$	152.0 ksi
layer 3	$f_{pe} =$	160.2 ksi
layer 4	$f_{pe} =$	164.4 ksi
layer 5	$f_{pe} =$	168.5 ksi
layer 6	$f_{pe} =$	170.5 ksi
layer 7	$f_{pe} =$	172.6 ksi
layer 8	$f_{pe} =$	197.2 ksi
layer 9	$f_{pe} =$	180.8 ksi
layer 10	$f_{pe} =$	205.4 ksi
layer 11	$f_{pe} =$	205.4 ksi
layer 12	$f_{pe} =$	205.4 ksi
layer 13	$f_{pe} =$	205.4 ksi
layer 14	$f_{pe} =$	205.4 ksi

Modulus of Elasticity

initial = 25898 ksi

layer 1 (bottom)	E =	25898.0 ksi
layer 2	E =	26157.0 ksi
layer 3	E =	26933.9 ksi
layer 4	E =	27451.9 ksi
layer 5	E =	27710.9 ksi
layer 6	E =	27710.9 ksi
layer 7	E =	27710.9 ksi
layer 8	E =	27710.9 ksi
layer 9	E =	27710.9 ksi
layer 10	E =	25898.0 ksi
layer 11	E =	25898.0 ksi
layer 12	E =	25898.0 ksi
layer 13	E =	25898.0 ksi
layer 14	E =	25898.0 ksi

#### REINFORCING BARS

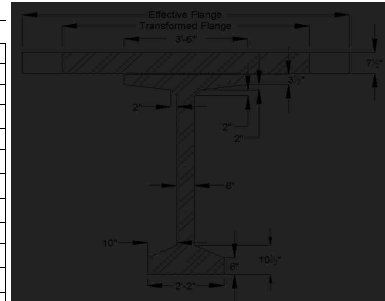
Yield Strength	$f_y =$	57.6 ksi
Modulus of Elasticity	E =	29000.0 ksi

Area of steel at endspan (effective flange)	$A_{se} =$	15.4 in <sup>2</sup>
Area of steel at midspan (effective flange)	$A_{sm} =$	0.0 in <sup>2</sup>
Area of temperature and shrinkage steel (12" width)	$A_{st} =$	0.0 in <sup>2</sup>

#### Cross-sectional Properties

##### NON-COMPOSITE BEAM

Area of cross-section of beam	A =	767.0 in <sup>2</sup>
Overall depth of beam	H =	72.0 in
Moment of Inertia	I =	211,427 in <sup>4</sup>
Distance from centroid to extreme <b>bottom</b> fiber	$y_b =$	51.1 in
Distance from centroid to extreme <b>top</b> fiber	$y_t =$	20.9 in
Section modulus for the extreme <b>bottom</b> fiber	$S_b =$	14915.0 in <sup>3</sup>
Section modulus for the extreme <b>top</b> fiber	$S_t =$	15421.0 in <sup>3</sup>
Weight	$W_t =$	799.0 plf
Modulus of Elasticity = $33000 \cdot (W_c^{1.5}) \cdot (\sqrt{f_c})$		
cast-in-place concrete deck	$E_{cs} =$	3834 ksi
precast beam at release	$E_{ci} =$	4496 ksi
precast beam at service loads	$E_c =$	4480 ksi



**COMPOSITE BEAM AT MIDSPAN**

Effective Flange Width	$b_f =$	111.0 in	*min of three criteria
Modular Ratio = $E_{cs}/E_c$	$n =$	0.8559	
Transformed flange width	$=$	95.0 in	
Transformed flange area	$=$	712.6 in <sup>2</sup>	
Transformed haunch width	$=$	35.9 in	
Transformed haunch area	$=$	18.0 in <sup>2</sup>	

	Transformed Area	$y_b$	$Ay_b$	$A(y_{bc}-y_b)^2$	I	$I + A(y_{bc}-y_b)^2$
Beam	767.0 in <sup>2</sup>	51.14 in	39,224.4 in <sup>3</sup>	114,183 in <sup>4</sup>	211,427 in <sup>4</sup>	325,610 in <sup>4</sup>
Haunch	18.0 in <sup>2</sup>	72.25 in	1,298.6 in <sup>3</sup>	1,427 in <sup>4</sup>	0.33 in <sup>4</sup>	1,427 in <sup>4</sup>
Deck	712.6 in <sup>2</sup>	76.25 in	54,332.3 in <sup>3</sup>	118,738 in <sup>4</sup>	2,950 in <sup>4</sup>	121,687 in <sup>4</sup>
Total	1497.5 in <sup>2</sup>		94,855.3 in <sup>3</sup>			448,724 in <sup>4</sup>

Total area of Composite Section	$A_c =$	1498 in <sup>2</sup>
Overall Depth of the Composite Section	$h_c =$	80 in
Moment of Inertia	$I_c =$	448,724 in <sup>4</sup>
Distance from centroid to extreme <u>bottom</u> fiber of beam	$y_{bc} =$	63.34 in
Distance from centroid to extreme <u>top</u> fiber of beam	$y_{tb} =$	8.66 in
Distance from centroid to extreme <u>top</u> fiber of slab	$y_{tc} =$	16.66 in
Section modulus for the extreme <u>bottom</u> fiber of beam	$S_{bc} =$	7,084.2 in <sup>3</sup>
Section modulus for the extreme <u>top</u> fiber of beam	$S_{tb} =$	51,823.0 in <sup>3</sup>
Section modulus for the extreme <u>top</u> fiber slab	$S_{tc} =$	31,470.4 in <sup>3</sup>

**Shear Forces and Bending Moments**

**DEAD LOADS**

Beam self-weight	$w_{beam} =$	0.799 k/f
8 in. deck weight	$w_{deck} =$	1.200 k/f
1/2 in. haunch weight	$w_{haunch} =$	0.022 k/f

LRFD Specifications: Art. 4.6.2.2.1

Width of Deck Constant		OK
Number of beams is not less than four $N_b =$	4	OK
Roadway part of the overhang, $d_o \leq 3.0$ ft, $d_o =$	1.5	OK
Curvature in plans is less than $4^\circ =$	0	OK
Cross-section of the bridge is consistent with one of the cross sections given by LRFD specs		OK

Barrier and wearing surface loads are equally distributed among the 4 beams

Barrier Wt	$Wt =$	0.150 k/f
Dead load of future wearing surface	$DW =$	0.263 k/f

**LIVE LOADS**

Fire truck live load front load (Point A)	$P_{live} =$	48.0 kips
Fire truck live load back load (Point B)	$P_{live} =$	22.0 kips
distance between two loads		19.2 ft
distance from nearest edge to point A	$x_a =$	59.0 ft
distance from nearest edge to point B	$x_b =$	39.8 ft

LRFD Specifications: Art. 4.6.2.2.1

Width of Deck Constant		OK
Number of beams is not less than four $N_b =$	4	OK
Beams are parallel and approximately of the same stiffness		OK
Roadway part of the overhang, $d_o \leq 3.0$ ft, $d_o =$	1.5	OK
Curvature in plans is less than $4^\circ =$	0	OK

Barrier and wearing surface loads are equally distributed among the 4 beams

Bridge Type-- "k" (LRFD Table 4.6.2.2.1-1)

Number of design lanes = $w/12$	$=$	3 lanes
---------------------------------	-----	---------

**Distribution Factor for Bending Moment:**

Beams spacing	S =	12.0 ft
Depth of concrete slab	t <sub>s</sub> =	7.5 in
Beam Span	L =	120.0 ft
Number of Beams	N <sub>b</sub> =	4
Modular ratio between beam & deck materials	n =	1.1683
Longitudinal stiffness parameter	K <sub>g</sub> =	1,655,812.84 in <sup>4</sup>

at center span:

$$DFM = 0.75 + \left(\frac{S}{9.5}\right)^{0.4} * \left(\frac{S}{L}\right)^{0.3} * \left(\frac{K_g}{12 * L * t_s^3}\right)^{0.1}$$

DFM =	0.877 lanes/beam
-------	------------------

one design lane loaded:

$$DFM = 0.75 - \left(\frac{S}{14}\right)^{0.4} * \left(\frac{S}{L}\right)^{0.3} * \left(\frac{K_g}{12 * L * t_s^3}\right)^{0.1}$$

DFM =	0.596 lanes/beam
-------	------------------

0.905 Controls

**Distribution Factor for Shear Force**

both end spans and center span:

$$DFV = 0.2 + \left(\frac{S}{12}\right) - \left(\frac{S}{35}\right)^2$$

DFV =	1.082 lanes/beam
-------	------------------

one design lane loaded:

$$DFV = 0.36 \left(\frac{S}{25}\right)$$

DFV =	0.840 lanes/beam
-------	------------------

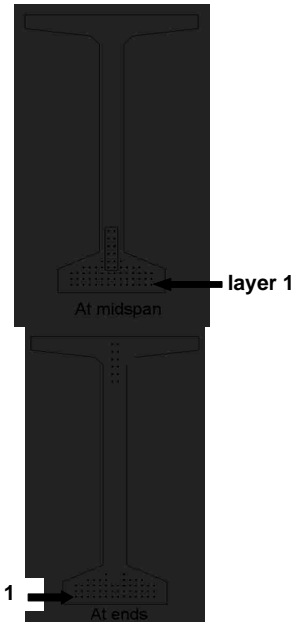
1.082 Controls

from bottom	At Midspan		At Ends	
	No. of	Distance from Bottom	No. of	Distance from Bottom
layer 1	14	2	14	2
layer 2	14	3.5	14	3.5
layer 3	14	5	14	5
layer 4	10	6.5	8	6.5
layer 5	4	8	2	8
layer 6	2	10	-	-
layer 7	2	12	-	-
layer 8	2	14	-	-
layer 9	2	16	2	60
layer 10	-	-	2	62
layer 11	-	-	2	64
layer 12	-	-	2	66
layer 13	-	-	2	68
layer 14	-	-	2	70
	64		64	
<b>Harped Strand Group (included in above totals)</b>				
layer 3	2	6		
layer 4	2	8		
layer 5	2	10		
layer 6	2	12		
layer 7	2	14		
layer 8	2	16		

distance from the center of gravity of strands to the bottom fiber of the beam = 7% of the beam depth  
strand eccentricity at midspan = (y<sub>c</sub> - y<sub>bs</sub>)

y <sub>bs</sub> =	5.44 in
e <sub>c</sub> =	45.70 in

layer 1



## Prestress Losses

### ELASTIC SHORTENING

assumed loss	=	6.00%
Force per strand at transfer		
layer 1	=	9.0 kips
layer 2	=	11.6 kips
layer 3	=	13.5 kips
layer 4	=	14.1 kips
layer 5	=	15.0 kips
layer 6	=	15.3 kips
layer 7	=	15.5 kips
layer 8	=	15.8 kips
layer 9	=	16.0 kips
layer 10	=	17.0 kips
layer 11	=	17.0 kips
layer 12	=	17.0 kips
layer 13	=	17.0 kips
layer 14	=	17.0 kips

Total prestressing force at release	$P_1 =$	at midspan 803.6 kips	at endspan 792.2 kips
Sum of concrete stresses at the center of gravity of prestressing tendons due to prestressing force at transfer and the self-weight of the member at sections of maximum moment	$f_{cgp} =$	5.379 ksi	5.252 ksi
Loss due to shortening		at midspan	at endspan
layer 1	$\Delta f_{pES} =$	31.0 ksi	30.3 ksi
layer 2	$\Delta f_{pES} =$	31.3 ksi	30.6 ksi
layer 3	$\Delta f_{pES} =$	32.2 ksi	31.5 ksi
layer 4	$\Delta f_{pES} =$	32.8 ksi	32.1 ksi
layer 5	$\Delta f_{pES} =$	33.2 ksi	32.4 ksi
layer 6	$\Delta f_{pES} =$	33.2 ksi	
layer 7	$\Delta f_{pES} =$	33.2 ksi	
layer 8	$\Delta f_{pES} =$	33.2 ksi	
layer 9	$\Delta f_{pES} =$	33.2 ksi	32.4 ksi
layer 10	$\Delta f_{pES} =$		30.3 ksi
layer 11	$\Delta f_{pES} =$		30.3 ksi
layer 12	$\Delta f_{pES} =$		30.3 ksi
layer 13	$\Delta f_{pES} =$		30.3 ksi
layer 14	$\Delta f_{pES} =$		30.3 ksi

### SHRINKAGE

Shrinkage = $(17 - 0.15 \cdot \text{Relative Humidity})$	$\Delta f_{pSR} =$	6.5 ksi	← assume relative humidity = 70%
--	--------------------	---------	----------------------------------

### CREEP OF CONCRETE

Change of stresses at center of gravity of prestressing due to permanent loads except the loads acting at time of applying prestressing force, calculated at the same section as $f_{cgp}$	$\Delta f_{cgp} =$	5.828 ksi	
loss due to creep	$\Delta f_{pCR} =$	at midspan 23.8 ksi	at endspan 22.2 ksi

**RELAXATION OF PRESTRESSING STRANDS**

loss due to relaxation after transfer		at midspan	at endspan
layer 1	$\Delta f_{pR2} =$	0.5 ksi	0.6 ksi
layer 2	$\Delta f_{pR2} =$	0.4 ksi	0.5 ksi
layer 3	$\Delta f_{pR2} =$	0.3 ksi	0.4 ksi
layer 4	$\Delta f_{pR2} =$	0.2 ksi	0.3 ksi
layer 5	$\Delta f_{pR2} =$	0.2 ksi	0.3 ksi
layer 6	$\Delta f_{pR2} =$	0.2 ksi	
layer 7	$\Delta f_{pR2} =$	0.2 ksi	
layer 8	$\Delta f_{pR2} =$	0.2 ksi	
layer 9	$\Delta f_{pR2} =$	0.2 ksi	0.3 ksi
layer 10	$\Delta f_{pR2} =$		0.6 ksi
layer 11	$\Delta f_{pR2} =$		0.6 ksi
layer 12	$\Delta f_{pR2} =$		0.6 ksi
layer 13	$\Delta f_{pR2} =$		0.6 ksi
layer 14	$\Delta f_{pR2} =$		0.6 ksi

**TOTAL LOSSES AT TRANSFER**

total loss  $\Delta f_{pES} = \Delta f_{pt}$

stress in tendons after transfer  $f_{pt} = f_{pr} - \Delta f_{pt}$

		at midspan	at endspan
layer 1	$f_{pt} =$	82.0 ksi	82.7 ksi
layer 2	$f_{pt} =$	113.6 ksi	114.4 ksi
layer 3	$f_{pt} =$	136.2 ksi	136.9 ksi
layer 4	$f_{pt} =$	144.1 ksi	144.8 ksi
layer 5	$f_{pt} =$	154.4 ksi	155.2 ksi
layer 6	$f_{pt} =$	158.7 ksi	
layer 7	$f_{pt} =$	160.8 ksi	
layer 8	$f_{pt} =$	165.1 ksi	
layer 9	$f_{pt} =$	167.2 ksi	168.0 ksi
layer 10	$f_{pt} =$		182.9 ksi
layer 11	$f_{pt} =$		182.9 ksi
layer 12	$f_{pt} =$		182.9 ksi
layer 13	$f_{pt} =$		182.9 ksi
layer 14	$f_{pt} =$		182.9 ksi

force per strand =  $f_{pt} \cdot \text{strand area}$

		at midspan	at endspan
layer 1	=	7.0 kips	7.0 kips
layer 2	=	9.7 kips	9.7 kips
layer 3	=	11.6 kips	11.6 kips
layer 4	=	12.2 kips	12.3 kips
layer 5	=	13.1 kips	13.2 kips
layer 6	=	13.5 kips	
layer 7	=	13.7 kips	
layer 8	=	14.0 kips	
layer 9	=	14.2 kips	14.3 kips
layer 10	=		15.5 kips
layer 11	=		15.5 kips
layer 12	=		15.5 kips
layer 13	=		15.5 kips
layer 14	=		15.5 kips

Total prestressing force after transfer  $P_1 =$  653.0 kips      678.2 kips

Initial loss =  $(\Delta f_p)/(f_{pi})$

		at midspan	at endspan
layer 1	% =	27.4%	26.8%
layer 2	% =	21.6%	21.1%
layer 3	% =	19.1%	18.7%
layer 4	% =	18.6%	18.1%
layer 5	% =	17.7%	17.3%
layer 6	% =	17.3%	
layer 7	% =	17.1%	
layer 8	% =	16.7%	
layer 9	% =	16.5%	16.2%
layer 10	% =		14.2%
layer 11	% =		14.2%
layer 12	% =		14.2%
layer 13	% =		14.2%
layer 14	% =		14.2%

OK  
OK  
OK  
OK  
OK  
OK  
OK  
OK  
OK  
OK  
OK  
OK  
OK

**TOTAL LOSSES AT SERVICE LOADS**

Total Losses		at midspan	at endspan
layer 1	$\Delta f_{pT} =$	61.7 ksi	61.0 ksi
layer 2	$\Delta f_{pT} =$	62.0 ksi	61.3 ksi
layer 3	$\Delta f_{pT} =$	62.9 ksi	62.2 ksi
layer 4	$\Delta f_{pT} =$	63.6 ksi	62.8 ksi
layer 5	$\Delta f_{pT} =$	63.9 ksi	63.1 ksi
layer 6	$\Delta f_{pT} =$	63.9 ksi	
layer 7	$\Delta f_{pT} =$	63.9 ksi	
layer 8	$\Delta f_{pT} =$	63.9 ksi	
layer 9	$\Delta f_{pT} =$	63.9 ksi	63.1 ksi
layer 10	$\Delta f_{pT} =$		61.0 ksi
layer 11	$\Delta f_{pT} =$		61.0 ksi
layer 12	$\Delta f_{pT} =$		61.0 ksi
layer 13	$\Delta f_{pT} =$		61.0 ksi
layer 14	$\Delta f_{pT} =$		61.0 ksi

Stress in tendon after all losses =  $f_{pi} - \Delta f_{pt}$

		at midspan	at endspan
layer 1	$f_{pe} =$	51.3 ksi	52.0 ksi
layer 2	$f_{pe} =$	82.9 ksi	83.7 ksi
layer 3	$f_{pe} =$	105.4 ksi	106.2 ksi
layer 4	$f_{pe} =$	113.4 ksi	114.1 ksi
layer 5	$f_{pe} =$	123.7 ksi	124.5 ksi
layer 6	$f_{pe} =$	128.0 ksi	
layer 7	$f_{pe} =$	130.1 ksi	
layer 8	$f_{pe} =$	134.4 ksi	
layer 9	$f_{pe} =$	136.5 ksi	137.3 ksi
layer 10	$f_{pe} =$		152.2 ksi
layer 11	$f_{pe} =$		152.2 ksi
layer 12	$f_{pe} =$		152.2 ksi
layer 13	$f_{pe} =$		152.2 ksi
layer 14	$f_{pe} =$		152.2 ksi

check prestressing stress limit at service limit state:  $f_{pe} \leq 0.8 \cdot f_{py}$

layer 1	=	123.3 ksi
layer 2	=	152.0 ksi
layer 3	=	160.2 ksi
layer 4	=	164.4 ksi
layer 5	=	168.5 ksi
layer 6	=	170.5 ksi
layer 7	=	172.6 ksi
layer 8	=	197.2 ksi
layer 9	=	180.8 ksi
layer 10	=	205.4 ksi
layer 11	=	205.4 ksi
layer 12	=	205.4 ksi
layer 13	=	205.4 ksi
layer 14	=	205.4 ksi

OK  
OK  
OK  
OK  
OK  
OK  
OK  
OK  
OK  
OK  
OK  
OK  
OK  
OK



force per strand =  $f_{pe}$  \* strand area

		at midspan	at endspan
layer 1	=	4.4 kips	4.4 kips
layer 2	=	7.0 kips	7.1 kips
layer 3	=	9.0 kips	9.0 kips
layer 4	=	9.6 kips	9.7 kips
layer 5	=	10.5 kips	10.6 kips
layer 6	=	10.9 kips	
layer 7	=	11.1 kips	
layer 8	=	11.4 kips	
layer 9	=	11.6 kips	11.7 kips
layer 10	=		12.9 kips
layer 11	=		12.9 kips
layer 12	=		12.9 kips
layer 13	=		12.9 kips
layer 14	=		12.9 kips

		at midspan	at endspan
Total prestressing force after all losses	$P_{pe}$ =	513.5 kips	539.3 kips

Final losses, % =  $(\Delta f_{pr}) / (f_{pi})$

layer 1	% =	54.6%	54.0%
layer 2	% =	54.9%	54.2%
layer 3	% =	55.7%	55.0%
layer 4	% =	56.3%	55.6%
layer 5	% =	56.5%	55.8%
layer 6	% =	56.5%	
layer 7	% =	56.5%	
layer 8	% =	56.5%	
layer 9	% =	56.5%	55.8%
layer 10	% =		54.0%
layer 11	% =		54.0%
layer 12	% =		54.0%
layer 13	% =		54.0%
layer 14	% =		54.0%
Average final losses, %	% =	56.0%	54.6%

### Stresses at Transfer

#### STRESS LIMITS FOR CONCRETE

Compression = $0.6f_{ci}$	$f_{ci}$ =	3.300 ksi
Tension		
without bonded reinforcement = $-0.0948\sqrt{f_{ci}} \leq -0.2$	=	-0.200 ksi
with bonded auxiliary reinforcement = $-0.22\sqrt{f_{ci}}$	=	-0.016 ksi

#### STRESSES AT TRANSFER LENGTH SECTION

Transfer Length = $60 \times$ (strand diameter)	=	1.9 ft
Bending moment at transfer length	$M_g$ =	87.7 ft-kips
center of 12 strands to top fiber of beam at the end	=	7.00 in
center of 12 strands to bottom fiber of beam at the harp point	=	11.00 in
center of 12 strands and top fiber of beam at transfer length	=	9.84 in
center of gravity of 32 strands and bottom fiber of beam	=	3.98 in
center of gravity of all strands and the bottom fiber of beam at transfer length	=	15.24 in
center of gravity of all strands and the bottom fiber of beam at the end	=	15.30 in
Eccentricity of the strand group at transfer length:	$e_n$ =	35.90 in
Eccentricity at end of beam:	$e$ =	35.84 in

} Calcs for eccentricity (see 9.6.7.2)

$$f_t = \frac{P_i}{A} - \frac{P_i e}{S_t} + \frac{M_g}{S_t}$$

$$f_b = \frac{P_i}{A} + \frac{P_i e}{S_b} - \frac{M_g}{S_b}$$

		at midspan	at endspan
Top stress at top fiber of beam	$f_t$ =	-0.600 ksi	-0.626 ksi
Bottom stress at bottom fiber of the beam	$f_b$ =	2.911 ksi	2.911 ksi

OK  
OK

STRESSES AT HARP POINT			
Bending moment due to beam weight at 0.3L	$M_g =$	1188.0 ft-kips	
Top stress at top fiber of beam	$f_t =$	-0.159 ksi	-0.201 ksi
Bottom stress at bottom fiber of the beam	$f_b =$	2.554 ksi	2.007 ksi

OK  
OK

STRESSES AT MIDSPAN			
Bending moment due to beam weight at 0.5L	$M_g =$	1414.3 ft-kips	
Top stress at top fiber of beam	$f_t =$	-0.233 ksi	-0.025 ksi
Bottom stress at bottom fiber of the beam	$f_b =$	2.372 ksi	1.824 ksi

OK  
OK

#### HOLD-DOWN FORCES

assume stress in strand before losses =  $0.8f_u$

layer 1	=	120.5 ksi
layer 2	=	154.6 ksi
layer 3	=	179.6 ksi
layer 4	=	188.7 ksi
layer 5	=	200.1 ksi
layer 6	=	204.6 ksi
layer 7	=	206.9 ksi
layer 8	=	211.4 ksi
layer 9	=	213.7 ksi
layer 10	=	227.4 ksi
layer 11	=	227.4 ksi
layer 12	=	227.4 ksi
layer 13	=	227.4 ksi
layer 14	=	227.4 ksi

prestress force per strand before any losses:

layer 1	=	10.2 kips
layer 2	=	13.1 kips
layer 3	=	15.3 kips
layer 4	=	16.0 kips
layer 5	=	17.0 kips
layer 6	=	17.4 kips
layer 7	=	17.6 kips
layer 8	=	18.0 kips
layer 9	=	18.2 kips
layer 10	=	19.3 kips
layer 11	=	19.3 kips
layer 12	=	19.3 kips
layer 13	=	19.3 kips
layer 14	=	19.3 kips
Harp Angle	$\psi =$	7.2 °

Hold-down force/strand

layer 1	=	1.3 kips/strand
layer 2	=	1.7 kips/strand
layer 3	=	2.0 kips/strand
layer 4	=	2.1 kips/strand
layer 5	=	2.2 kips/strand
layer 6	=	2.3 kips/strand
layer 7	=	2.3 kips/strand
layer 8	=	2.4 kips/strand
layer 9	=	2.4 kips/strand
layer 10	=	2.5 kips/strand
layer 11	=	2.5 kips/strand
layer 12	=	2.5 kips/strand
layer 13	=	2.5 kips/strand
layer 14	=	2.5 kips/strand
Total hold-down force	=	26.60 kips

### Stresses at Service Loads

#### STRESS LIMITS FOR CONCRETE

##### Compression:

Due to permanent loads for load combination Service I

for the precast beam	=	2.457 ksi
for deck	=	1.800 ksi

Due to permanent and transient loads for load combination Service I

for the precast beam	=	3.276 ksi
for deck	=	2.400 ksi

##### Tension:

Load Combination Service III

for the precast beam	=	-0.014 ksi
----------------------	---	------------

#### STRESSES AT MIDSPAN

Compression stresses at top fiber of beam	at midspan	at endspan		
$f_t = \frac{P_{ps}}{A} - \frac{P_{ps}e}{S_t} + \frac{(M_D + M_{D'})}{S_t} + \frac{(M_{ws} + M_D)}{S_{tw}}$				
Due to permanent loads	$f_{t0} =$	1.931 ksi	1.889 ksi	OK
$f_{tw} = \frac{P_{ps}}{A} - \frac{P_{ps}e}{S_t} + \frac{(M_D + M_{D'})}{S_t} + \frac{(M_{ws} + M_D)}{S_{tw}} + \frac{(M_{LL+I})}{S_{tw}}$				
Due to permanent loads and transient loads	$f_{tw} =$	2.421 ksi	2.378 ksi	OK
Compression stresses at top fiber of deck	at midspan	at endspan		
$f_{tc} = \frac{(M_{ws} + M_D)}{S_{tr}}$				
Due to permanent loads	$f_{tc} =$	0.077 ksi	0.077 ksi	OK
$f_{tw} = \frac{(M_{ws} + M_D + M_{LL+I})}{S_{tr}}$				
Due to permanent loads and transient loads	$f_{tw} =$	0.883 ksi	0.883 ksi	OK
Tension stresses at top fiber of deck	at midspan	at endspan		
$f_{tr} = \frac{P_{ps}}{A} + \frac{P_{ps}e}{S_b} - \frac{(M_D + M_{D'})}{S_b} - \frac{(M_{ws} + M_D + 0.8 * M_{LL+I})}{S_{tr}}$				
Load Combination Service III	$f_b =$	-3.794 ksi	-3.681 ksi	OK

### Strength Limit State

#### POSITIVE MOMENT SECTION

$M_u = 1.25DC + 1.5DW + 1.75(LL+IM)$	$M_u =$	8381.5 ft-kips
--------------------------------------	---------	----------------

effective length factor for compression members

layer 1	k =	0.03
layer 2	k =	0.11
layer 3	k =	0.30
layer 4	k =	0.34
layer 5	k =	0.40
layer 6	k =	0.41
layer 7	k =	0.41
layer 8	k =	0.21
layer 9	k =	0.39
layer 10	k =	0.27
layer 11	k =	0.27
layer 12	k =	0.27
layer 13	k =	0.27
layer 14	k =	0.27
c =		3.4 ft-kips

average stress in prestressing steel

layer 1	$f_{ps} =$	150.4 ksi
layer 2	$f_{ps} =$	193.0 ksi
layer 3	$f_{ps} =$	224.2 ksi
layer 4	$f_{ps} =$	235.5 ksi
layer 5	$f_{ps} =$	249.7 ksi
layer 6	$f_{ps} =$	255.4 ksi
layer 7	$f_{ps} =$	258.2 ksi
layer 8	$f_{ps} =$	263.9 ksi
layer 9	$f_{ps} =$	266.7 ksi
layer 10	$f_{ps} =$	283.8 ksi
layer 11	$f_{ps} =$	283.8 ksi
layer 12	$f_{ps} =$	283.8 ksi
layer 13	$f_{ps} =$	283.8 ksi
layer 14	$f_{ps} =$	283.8 ksi

nominal flexure resistance

$a =$	2.87 in
$\Phi M_n =$	6884.6 ft-kips
$M = DC+W+LL+IM$	5833.6 ft-kips

NOT OK  
OK

**NEGATIVE MOMENT SECTION**

$M_u = 1.25DC+1.5DW+1.75(LL+IM)$	$M_u =$	4837.2 ft-kips
	$a =$	7.35 in
	$\Phi M_n =$	4825.3 ft-kips
$M = DC+W+LL+IM$	$M =$	2869.7 ft-kips

NOT OK  
OK

**Shear Design**

**CRITICAL SECTION AT 0.59**

$V_u = 1.25DC+1.5DW+1.75(LL+IM)$	$V_u =$	405.0 kips
$M_u = 1.25DC+1.5DW+1.75(LL+IM)$	$M_u =$	-2684.4 ft-kips
or		
$V_u = 1.25DC+1.5DW+1.75(LL+IM)$	$V_u =$	364.8 kips
$M_u = 1.25DC+1.5DW+1.75(LL+IM)$	$M_u =$	-2877.0 ft-kips
max shear	$V_u =$	405.0 kips
max moment	$M_u =$	2877.0 ft-kips
Shear depth	$d_v =$	73.19 in
Applied factored normal force at the section	$N_u =$	0
Angle of diagonal compressive stresses	$\theta =$	36.00 °

**STRAIN IN FLEXURAL TENSION REINFORCEMENT**

$$\epsilon_s = \frac{\frac{M_u}{d_s} + 0.5M_u + 0.5M_u \cot \theta + A_{ps} f_{pr}}{E_s d_s + E_s d_{ps}} \leq 0.002$$

resultant compressive stress at centroid

	at midspan	at endspan
$f_{pc} =$	0.160 ksi	0.144 ksi

effective stress in prestressing strand after all losses

layer 1	$f_{po} =$	52.2 ksi	52.8 ksi
layer 2	$f_{po} =$	83.9 ksi	84.5 ksi
layer 3	$f_{po} =$	106.4 ksi	107.1 ksi
layer 4	$f_{po} =$	114.3 ksi	115.0 ksi
layer 5	$f_{po} =$	124.7 ksi	
layer 6	$f_{po} =$	128.9 ksi	
layer 7	$f_{po} =$	131.1 ksi	
layer 8	$f_{po} =$	135.3 ksi	
layer 9	$f_{po} =$		138.2 ksi
layer 10	$f_{po} =$		153.0 ksi
layer 11	$f_{po} =$		153.0 ksi
layer 12	$f_{po} =$		153.0 ksi
layer 13	$f_{po} =$		153.0 ksi
layer 14	$f_{po} =$		153.0 ksi

strain in flexural tension

	at midspan	at endspan
layer 1	$\epsilon_x = 0.001475$	0.001473
layer 2	$\epsilon_x = 0.001406$	0.001404
layer 3	$\epsilon_x = 0.001355$	0.001353
layer 4	$\epsilon_x = 0.001336$	0.001335
layer 5	$\epsilon_x = 0.001313$	
layer 6	$\epsilon_x = 0.001304$	
layer 7	$\epsilon_x = 0.001299$	
layer 8	$\epsilon_x = 0.001290$	
layer 9	$\epsilon_x =$	0.001284
layer 10	$\epsilon_x =$	0.001257
layer 11	$\epsilon_x =$	0.001257
layer 12	$\epsilon_x =$	0.001257
layer 13	$\epsilon_x =$	0.001257
layer 14	$\epsilon_x =$	0.001257

### Deflection and Camber

	at midspan	at endspan
Deflection due to Prestressing Force at Transfer	$\Delta_p = 3.27$ in	3.29 in
Deflection due to Beam Self-Weight at Transfer	$\Delta_{sw} = -3.79$ in	
Deflection due to Beam Self-Weight at Erection	$\Delta_{sw} = -3.68$ in	
Deflection due to Haunch and Deck	$\Delta_s = -5.63$ in	
Deflection due to total self weight	$\Delta_{sw} = -6.03$ in	
Total Deflection at transfer	$\Delta = -0.52$ in	-0.50 in
Total Deflection at erection	$\Delta = -0.92$ in	-0.88 in
Live load deflection limit = span/800	= -1.80 in	
Deflection due to live load and impact	$\Delta_L = -2.18$ in	
Deflection due to fire truck	$\Delta_L = -4.1776$ in	
Total Deflection after fire with fire truck	$\Delta = -6.9386$ in	

NOT OK

NOT OK

**Location: Fire at Critical Negative Moment Sections**  
**Beam Design: 1/2" Strand**  
**Fire Exposure Status: Undamaged**

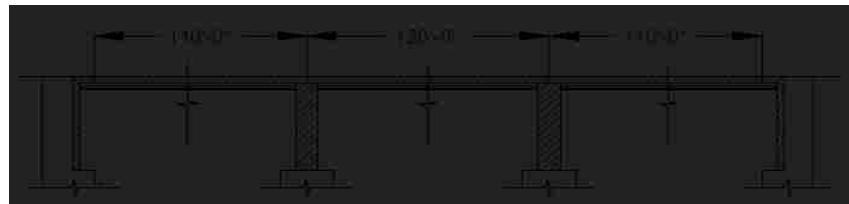
(PCI Bridge Design Manual Section 9.6)



**Material Properties**

CAST-IN-PLACE SLAB		
Actual Thickness	$t_{as} =$	8.0 in
Wearing Surface	$=$	0.5 in
Structural thickness = Actual - Wearing Surface	$t_s =$	7.5 in
Compressive Strength	$f'_c =$	4.00 ksi
Unit Weight	$w_c =$	150.0 pcf
Stress factor of compression block	$\beta_1 =$	0.85

BEAMS: AASHTO-PCI, BT-72 BULB-TEE		
Strength at release	$f'_{ci} =$	5.5 ksi
Strength at 28 days	$f'_c =$	7 ksi
Unit Weight	$w_c =$	150.0 pcf
Overall Beam Length:		
@ end spans	$L =$	110 ft
@ center span	$L =$	119 ft
Design Spans:		
Non-composite beam @ end spans	$L =$	109 ft
Non-composite beam @ center span	$L =$	118 ft
Composite beam @ end spans	$L =$	110 ft
Composite beam @ center span	$L =$	120 ft
Beam Spacing	$S =$	12 ft



**PRESTRESSING STRANDS**

Diameter of single strand	d =	0.5 in
Area of single strand	A =	0.153 in <sup>2</sup>

Temperature of Layer

layer 1 (bottom)	T =	68.00 °F
layer 2	T =	68.00 °F
layer 3	T =	68.00 °F
layer 4	T =	68.00 °F
layer 5	T =	68.00 °F
layer 6	T =	68.00 °F
layer 7	T =	68.00 °F
layer 8	T =	68.00 °F
layer 9	T =	68.00 °F
layer 10	T =	68.00 °F
layer 11	T =	68.00 °F
layer 12	T =	68.00 °F
layer 13	T =	68.00 °F
layer 14	T =	68.00 °F

Ultimate Strength

initial = 277 ksi

layer 1 (bottom)	$f_{pu}$ =	277 ksi
layer 2	$f_{pu}$ =	277 ksi
layer 3	$f_{pu}$ =	277 ksi
layer 4	$f_{pu}$ =	277 ksi
layer 5	$f_{pu}$ =	277 ksi
layer 6	$f_{pu}$ =	277 ksi
layer 7	$f_{pu}$ =	277 ksi
layer 8	$f_{pu}$ =	277 ksi
layer 9	$f_{pu}$ =	277 ksi
layer 10	$f_{pu}$ =	277 ksi
layer 11	$f_{pu}$ =	277 ksi
layer 12	$f_{pu}$ =	277 ksi
layer 13	$f_{pu}$ =	277 ksi
layer 14	$f_{pu}$ =	277 ksi

Yield Strength

initial = 250 ksi

layer 1 (bottom)	$f_{py}$ =	250 ksi
layer 2	$f_{py}$ =	250 ksi
layer 3	$f_{py}$ =	250 ksi
layer 4	$f_{py}$ =	250 ksi
layer 5	$f_{py}$ =	250 ksi
layer 6	$f_{py}$ =	250 ksi
layer 7	$f_{py}$ =	250 ksi
layer 8	$f_{py}$ =	250 ksi
layer 9	$f_{py}$ =	250 ksi
layer 10	$f_{py}$ =	250 ksi
layer 11	$f_{py}$ =	250 ksi
layer 12	$f_{py}$ =	250 ksi
layer 13	$f_{py}$ =	250 ksi
layer 14	$f_{py}$ =	250 ksi

Stress Limits:

before transfer  $\leq 0.75f_{pu}$  (initial = 207.6)

layer 1 (bottom)	$f_{pi}$ =	207.6 ksi
layer 2	$f_{pi}$ =	207.6 ksi
layer 3	$f_{pi}$ =	207.6 ksi
layer 4	$f_{pi}$ =	207.6 ksi
layer 5	$f_{pi}$ =	207.6 ksi
layer 6	$f_{pi}$ =	207.6 ksi
layer 7	$f_{pi}$ =	207.6 ksi
layer 8	$f_{pi}$ =	207.6 ksi
layer 9	$f_{pi}$ =	207.6 ksi
layer 10	$f_{pi}$ =	207.6 ksi
layer 11	$f_{pi}$ =	207.6 ksi
layer 12	$f_{pi}$ =	207.6 ksi
layer 13	$f_{pi}$ =	207.6 ksi
layer 14	$f_{pi}$ =	207.6 ksi

at service limit state (after all losses)  $\leq 0.80f_{py}$  (initial = 199.7)

layer 1 (bottom)	$f_{pe} =$	199.7 ksi
layer 2	$f_{pe} =$	199.7 ksi
layer 3	$f_{pe} =$	199.7 ksi
layer 4	$f_{pe} =$	199.7 ksi
layer 5	$f_{pe} =$	199.7 ksi
layer 6	$f_{pe} =$	199.7 ksi
layer 7	$f_{pe} =$	199.7 ksi
layer 8	$f_{pe} =$	199.7 ksi
layer 9	$f_{pe} =$	199.7 ksi
layer 10	$f_{pe} =$	199.7 ksi
layer 11	$f_{pe} =$	199.7 ksi
layer 12	$f_{pe} =$	199.7 ksi
layer 13	$f_{pe} =$	199.7 ksi
layer 14	$f_{pe} =$	199.7 ksi

Modulus of Elasticity

initial = 25982 ksi

layer 1 (bottom)	E =	25982.0 ksi
layer 2	E =	25982.0 ksi
layer 3	E =	25982.0 ksi
layer 4	E =	25982.0 ksi
layer 5	E =	25982.0 ksi
layer 6	E =	25982.0 ksi
layer 7	E =	25982.0 ksi
layer 8	E =	25982.0 ksi
layer 9	E =	25982.0 ksi
layer 10	E =	25982.0 ksi
layer 11	E =	25982.0 ksi
layer 12	E =	25982.0 ksi
layer 13	E =	25982.0 ksi
layer 14	E =	25982.0 ksi

### MILD STEEL REINFORCING BARS

Yield Strength

Layer 1 (Bottom)	$f_y =$	60.0 ksi	68.00 °F
Layer 2 (Top)	$f_y =$	60.0 ksi	68.00 °F

Modulus of Elasticity

E =	29000.0 ksi
-----	-------------

Layer 1 (Bottom)

Area of steel at midspan (effective flange)	$A_{sm} =$	2.79 in <sup>2</sup>
Area of steel at endspan (effective flange)	$A_{se} =$	2.48 in <sup>2</sup>
Area of temperature and shrinkage steel (12" width)	$A_s =$	0.31 in <sup>2</sup>

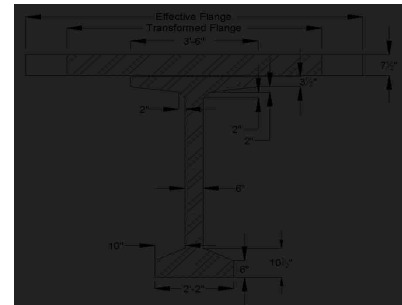
Layer 2 (Top)

Area of steel at midspan (effective flange)	$A_{sm} =$	12.6 in <sup>2</sup>
Area of steel at endspan (effective flange)	$A_{se} =$	12.4 in <sup>2</sup>
Area of temperature and shrinkage steel (12" width)	$A_s =$	0.2 in <sup>2</sup>

### Cross-sectional Properties

#### NON-COMPOSITE BEAM

Area of cross-section of beam	A =	767.0 in <sup>2</sup>
Overall depth of beam	H =	72.0 in
Moment of Inertia	I =	539,947 in <sup>4</sup>
Distance from centroid to extreme bottom fiber	$y_b =$	36.6 in
Distance from centroid to extreme top fiber	$y_t =$	35.4 in
Section modulus for the extreme bottom fiber	$S_b =$	14915.0 in <sup>3</sup>
Section modulus for the extreme top fiber	$S_t =$	15421.0 in <sup>3</sup>
Weight	$W_t =$	799.0 plf
Modulus of Elasticity = $33000 \cdot (W_c^{1.5}) \cdot (\sqrt{f_c})$		
cast-in-place concrete deck	$E_{cs} =$	3834 ksi
precast beam at release	$E_{ci} =$	4496 ksi
precast beam at service loads	$E_c =$	5072 ksi





### COMPOSITE BEAM AT MIDSPAN

Effective Flange Width	$b_f =$	111.0 in	*min of three criteria
Modular Ratio = $E_{cs}/E_c$	$n =$	0.7559	
Transformed flange width	$=$	83.9 in	
Transformed flange area	$=$	629.3 in <sup>2</sup>	
Transformed haunch width	$=$	31.7 in	
Transformed haunch area	$=$	15.9 in <sup>2</sup>	
Deck-distance to top fiber	$y_t =$	3.75 in	

	Transformed Area	$y_b$	$Ay_b$	$A(y_{bc}-y_b)^2$	$I$	$I + A(y_{bc}-y_b)^2$
Beam	767.0 in <sup>2</sup>	36.60 in	28,072.2 in <sup>3</sup>	250,443 in <sup>4</sup>	539,947 in <sup>4</sup>	790,390 in <sup>4</sup>
Haunch	15.9 in <sup>2</sup>	72.25 in	1,146.9 in <sup>3</sup>	4,906 in <sup>4</sup>	0.33 in <sup>4</sup>	4,906 in <sup>4</sup>
Deck	629.3 in <sup>2</sup>	76.25 in	47,985.0 in <sup>3</sup>	293,069 in <sup>4</sup>	2,950 in <sup>4</sup>	296,019 in <sup>4</sup>
Total	1412.2 in <sup>2</sup>		77,204.1 in <sup>3</sup>			1,091,316 in <sup>4</sup>

Total area of Composite Section	$A_c =$	1412 in <sup>2</sup>
Overall Depth of the Composite Section	$h_c =$	80 in
Moment of Inertia	$I_c =$	1,091,316 in <sup>4</sup>
Distance from centroid to extreme <u>bottom</u> fiber of beam	$y_{bc} =$	54.67 in
Distance from centroid to extreme <u>top</u> fiber of beam	$y_{tg} =$	17.33 in
Distance from centroid to extreme <u>top</u> fiber of slab	$y_{tc} =$	25.33 in
Section modulus for the extreme <u>bottom</u> fiber of beam	$S_{bc} =$	19,961.9 in <sup>3</sup>
Section modulus for the extreme <u>top</u> fiber of beam	$S_{tg} =$	62,972.4 in <sup>3</sup>
Section modulus for the extreme <u>top</u> fiber slab	$S_{tc} =$	56,994.5 in <sup>3</sup>

### COMPOSITE BEAM AT ENDSPAN

Effective Flange Width	$b_f =$	106.6 in	*min of three criteria
Modular Ratio = $E_{cs}/E_c$	$n =$	0.7559	
Transformed flange width	$=$	80.6 in	
Transformed flange area	$=$	604.4 in <sup>2</sup>	
Transformed haunch width	$=$	31.7 in	
Transformed haunch area	$=$	15.9 in <sup>2</sup>	
Deck-distance to top fiber	$y_{td} =$	3.75 in	

	Transformed Area	$y_t$	$Ay_t$	$A(y_{bc}-y_t)^2$	$I$	$I + A(y_{tc}-y_t)^2$
Beam	767.0 in <sup>2</sup>	36.60 in	28,072.2 in <sup>3</sup>	273,455 in <sup>4</sup>	539,947 in <sup>4</sup>	813,402 in <sup>4</sup>
Haunch	15.9 in <sup>2</sup>	72.25 in	1,146.9 in <sup>3</sup>	5,660 in <sup>4</sup>	0.33 in <sup>4</sup>	5,660 in <sup>4</sup>
Deck	604.4 in <sup>2</sup>	76.25 in	46,082.8 in <sup>3</sup>	215,472 in <sup>4</sup>	2,833 in <sup>4</sup>	218,305 in <sup>4</sup>
Total	1387.2 in <sup>2</sup>		75,302.0 in <sup>3</sup>			1,037,366 in <sup>4</sup>

Total area of Composite Section	$A_c =$	1387 in <sup>2</sup>
Overall Depth of the Composite Section	$h_c =$	80 in
Moment of Inertia	$I_c =$	1,037,366 in <sup>4</sup>
Distance from centroid to extreme <u>bottom</u> fiber of beam	$y_{bc} =$	54.28 in
Distance from centroid to extreme <u>top</u> fiber of beam	$y_{tg} =$	17.72 in
Distance from centroid to extreme <u>top</u> fiber of slab	$y_{tc} =$	25.72 in
Section modulus for the extreme <u>bottom</u> fiber of beam	$S_{bc} =$	19,110.7 in <sup>3</sup>
Section modulus for the extreme <u>top</u> fiber of beam	$S_{tg} =$	58,548.3 in <sup>3</sup>
Section modulus for the extreme <u>top</u> fiber slab	$S_{tc} =$	40,336.0 in <sup>3</sup>

### Shear Forces and Bending Moments

#### DEAD LOADS

Beam self-weight	$w_{beam} =$	0.799 k/f
8 in. deck weight	$w_{deck} =$	1.200 k/f
1/2 in. haunch weight	$w_{haunch} =$	0.022 k/f

#### LRFD Specifications: Art. 4.6.2.2.1

Width of Deck Constant		OK
Number of beams is not less than four $N_b =$	4	OK
Roadway part of the overhang, $d_o \leq 3.0$ ft, $d_o =$	1.5	OK
Curvature in plans is less than $4^\circ =$	0	OK
Cross-section of the bridge is consistent with one of the cross sections given by LRFD specs		OK

Barrier and wearing surface loads are equally distributed among the 4 beams

Barrier Wt	$W_t =$	0.150 k/f
Dead load of future wearing surface	$DW =$	0.263 k/f

### LIVE LOADS

Fire truck live load front load (Point A)	$P_{live} =$	48.0 kips
Fire truck live load back load (Point B)	$P_{live} =$	22.0 kips
distance between two loads		19.2 ft
distance from nearest edge to point A	$x_a =$	59.0 ft
distance from nearest edge to point B	$x_b =$	39.8 ft
LRFD Specifications: Art. 4.6.2.2.1		
Width of Deck Constant		OK
Number of beams is not less than four $N_b =$	4	OK
Beams are parallel and approximately of the same stiffness		OK
Roadway part of the overhang, $d_o \leq 3.0$ ft, $d_o =$	1.5	OK
Curvature in plans is less than $4^\circ =$	0	OK

Barrier and wearing surface loads are equally distributed among the 4 beams

Bridge Type-- "k" (LRFD Table 4.6.2.2.1-1)

Number of design lanes = $w/12$	=	3 lanes
---------------------------------	---	---------

### Distribution Factor for Bending Moment:

Beams spacing	$S =$	12.0 ft
Depth of concrete slab	$t_s =$	7.5 in
Beam Span	$L =$	120.0 ft
Number of Beams	$N_b =$	4
Modular ratio between beam & deck materials	$n =$	1.3229
Longitudinal stiffness parameter	$K_g =$	2,309,429.79 in <sup>4</sup>

at center span:

$$DFM = 0.75 + \left(\frac{S}{9.5}\right)^{0.6} * \left(\frac{S}{L}\right)^{0.2} * \left(\frac{K_g}{12 * L * t_s^3}\right)^{0.1}$$

DFM =	0.905 lanes/beam
-------	------------------

0.905 Controls

one design lane loaded:

$$DFM = 0.75 + \left(\frac{S}{14}\right)^{0.4} * \left(\frac{S}{L}\right)^{0.2} * \left(\frac{K_g}{12 * L * t_s^3}\right)^{0.2}$$

DFM =	0.614 lanes/beam
-------	------------------

### Distribution Factor for Shear Force

both end spans and center span:

$$DFV = 0.2 + \left(\frac{S}{12}\right) - \left(\frac{S}{35}\right)^2$$

DFV =	1.082 lanes/beam
-------	------------------

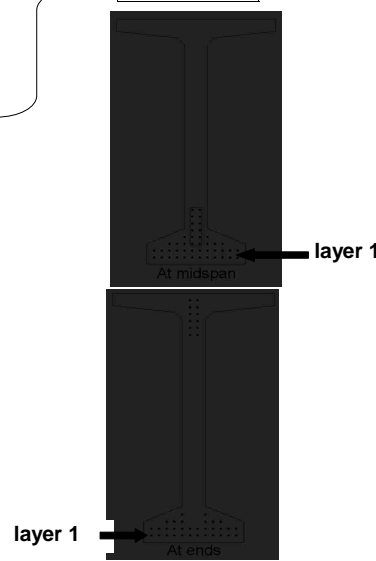
1.082 Controls

one design lane loaded:

$$DFV = 0.36 + \left(\frac{S}{25}\right)$$

DFV =	0.840 lanes/beam
-------	------------------

	At Midspan		At Ends	
from bottom	No. of	Distance from Bottom	No. of	Distance from Bottom
layer 1	12	2	12	2
layer 2	12	4	12	4
layer 3	8	6	6	6
layer 4	4	8	2	8
layer 5	2	10	-	-
layer 6	2	12	-	-
layer 7	2	14	-	-
layer 8	2	16	-	-
layer 9	-	-	2	60
layer 10	-	-	2	62
layer 11	-	-	2	64
layer 12	-	-	2	66
layer 13	-	-	2	68
layer 14	-	-	2	70
<b>Harped Strand Group (included in above totals)</b>				
layer 3	2	6		
layer 4	2	8		
layer 5	2	10		
layer 6	2	12		
layer 7	2	14		
layer 8	2	16		



distance from the center of gravity of strands to the bottom fiber of the beam = 7% of the beam depth  
strand eccentricity at midspan =  $(y_t - y_{bs})$

$y_{bs} =$	5.82 in
$e_c =$	30.78 in

### Prestress Losses

#### ELASTIC SHORTENING

assumed loss	=	9.00%
Force per strand at transfer		
layer 1	=	28.9 kips
layer 2	=	28.9 kips
layer 3	=	28.9 kips
layer 4	=	28.9 kips
layer 5	=	28.9 kips
layer 6	=	28.9 kips
layer 7	=	28.9 kips
layer 8	=	28.9 kips
layer 9	=	28.9 kips
layer 10	=	28.9 kips
layer 11	=	28.9 kips
layer 12	=	28.9 kips
layer 13	=	28.9 kips
layer 14	=	28.9 kips

		at midspan	at endspan
Total prestressing force at release	$P_i =$	1271.6 kips	1271.6 kips
Sum of concrete stresses at the center of gravity of prestressing tendons due to prestressing force at transfer and the self-weight of the member at sections of maximum moment	$f_{cgp} =$	2.938 ksi	2.938 ksi
Loss due to shortening		at midspan	at endspan
layer 1	$\Delta f_{PES} =$	17.0 ksi	17.0 ksi
layer 2	$\Delta f_{PES} =$	17.0 ksi	17.0 ksi
layer 3	$\Delta f_{PES} =$	17.0 ksi	17.0 ksi
layer 4	$\Delta f_{PES} =$	17.0 ksi	17.0 ksi
layer 5	$\Delta f_{PES} =$	17.0 ksi	
layer 6	$\Delta f_{PES} =$	17.0 ksi	
layer 7	$\Delta f_{PES} =$	17.0 ksi	
layer 8	$\Delta f_{PES} =$	17.0 ksi	
layer 9	$\Delta f_{PES} =$		17.0 ksi
layer 10	$\Delta f_{PES} =$		17.0 ksi
layer 11	$\Delta f_{PES} =$		17.0 ksi
layer 12	$\Delta f_{PES} =$		17.0 ksi
layer 13	$\Delta f_{PES} =$		17.0 ksi
layer 14	$\Delta f_{PES} =$		17.0 ksi

#### SHRINKAGE

Shrinkage =  $(17 - 0.15 \times \text{Relative Humidity})$   $\Delta f_{PSR} =$  6.5 ksi ← assume relative humidity = 70%

#### CREEP OF CONCRETE

Change of stresses at center of gravity of prestressing due to permanent loads except the loads acting at time of applying prestressing force, calculated at the same section as $f_{cgp}$	$\Delta f_{cdp} =$	1.563 ksi	
loss due to creep	$\Delta f_{PCR} =$	at midspan 24.3 ksi	at endspan 24.3 ksi

**RELAXATION OF PRESTRESSING STRANDS**

loss due to relaxation after transfer		at midspan	at endspan
layer 1	$\Delta f_{pR2} =$	2.1 ksi	2.1 ksi
layer 2	$\Delta f_{pR2} =$	2.1 ksi	2.1 ksi
layer 3	$\Delta f_{pR2} =$	2.1 ksi	2.1 ksi
layer 4	$\Delta f_{pR2} =$	2.1 ksi	2.1 ksi
layer 5	$\Delta f_{pR2} =$	2.1 ksi	
layer 6	$\Delta f_{pR2} =$	2.1 ksi	
layer 7	$\Delta f_{pR2} =$	2.1 ksi	
layer 8	$\Delta f_{pR2} =$	2.1 ksi	
layer 9	$\Delta f_{pR2} =$		2.1 ksi
layer 10	$\Delta f_{pR2} =$		2.1 ksi
layer 11	$\Delta f_{pR2} =$		2.1 ksi
layer 12	$\Delta f_{pR2} =$		2.1 ksi
layer 13	$\Delta f_{pR2} =$		2.1 ksi
layer 14	$\Delta f_{pR2} =$		2.1 ksi

**TOTAL LOSSES AT TRANSFER**

total loss $\Delta f_{pES} = \Delta f_{pi}$		at midspan	at endspan
stress in tendons after transfer $f_{pt} = f_{pi} - \Delta f_{pi}$			
layer 1	$f_{pt} =$	190.6 ksi	190.6 ksi
layer 2	$f_{pt} =$	190.6 ksi	190.6 ksi
layer 3	$f_{pt} =$	190.6 ksi	190.6 ksi
layer 4	$f_{pt} =$	190.6 ksi	190.6 ksi
layer 5	$f_{pt} =$	190.6 ksi	
layer 6	$f_{pt} =$	190.6 ksi	
layer 7	$f_{pt} =$	190.6 ksi	
layer 8	$f_{pt} =$	190.6 ksi	
layer 9	$f_{pt} =$		190.6 ksi
layer 10	$f_{pt} =$		190.6 ksi
layer 11	$f_{pt} =$		190.6 ksi
layer 12	$f_{pt} =$		190.6 ksi
layer 13	$f_{pt} =$		190.6 ksi
layer 14	$f_{pt} =$		190.6 ksi
force per strand = $f_{pt} \times \text{strand area}$			
		at midspan	at endspan
layer 1	=	29.2 kips	29.2 kips
layer 2	=	29.2 kips	29.2 kips
layer 3	=	29.2 kips	29.2 kips
layer 4	=	29.2 kips	29.2 kips
layer 5	=	29.2 kips	
layer 6	=	29.2 kips	
layer 7	=	29.2 kips	
layer 8	=	29.2 kips	
layer 9	=		29.2 kips
layer 10	=		29.2 kips
layer 11	=		29.2 kips
layer 12	=		29.2 kips
layer 13	=		29.2 kips
layer 14	=		29.2 kips
Total prestressing force after transfer		$P_t =$	1284.8 kips
Initial loss = $(\Delta f_{pi}) / (f_{pi})$			
		at midspan	at endspan
layer 1	% =	8.2%	8.2%
layer 2	% =	8.2%	8.2%
layer 3	% =	8.2%	8.2%
layer 4	% =	8.2%	8.2%
layer 5	% =	8.2%	
layer 6	% =	8.2%	
layer 7	% =	8.2%	
layer 8	% =	8.2%	
layer 9	% =		8.2%
layer 10	% =		8.2%
layer 11	% =		8.2%
layer 12	% =		8.2%
layer 13	% =		8.2%
layer 14	% =		8.2%

OK  
OK  
OK  
OK  
OK  
OK  
OK  
OK  
OK  
OK  
OK  
OK  
OK  
OK

**TOTAL LOSSES AT SERVICE LOADS**

Total Losses		at midspan	at endspan
layer 1	$\Delta f_{pT} =$	49.9 ksi	49.9 ksi
layer 2	$\Delta f_{pT} =$	49.9 ksi	49.9 ksi
layer 3	$\Delta f_{pT} =$	49.9 ksi	49.9 ksi
layer 4	$\Delta f_{pT} =$	49.9 ksi	49.9 ksi
layer 5	$\Delta f_{pT} =$	49.9 ksi	
layer 6	$\Delta f_{pT} =$	49.9 ksi	
layer 7	$\Delta f_{pT} =$	49.9 ksi	
layer 8	$\Delta f_{pT} =$	49.9 ksi	
layer 9	$\Delta f_{pT} =$		49.9 ksi
layer 10	$\Delta f_{pT} =$		49.9 ksi
layer 11	$\Delta f_{pT} =$		49.9 ksi
layer 12	$\Delta f_{pT} =$		49.9 ksi
layer 13	$\Delta f_{pT} =$		49.9 ksi
layer 14	$\Delta f_{pT} =$		49.9 ksi

Stress in tendon after all losses =  $f_{pe} - \Delta f_{pT}$

		at midspan	at endspan
layer 1	$f_{pe} =$	157.7 ksi	157.7 ksi
layer 2	$f_{pe} =$	157.7 ksi	157.7 ksi
layer 3	$f_{pe} =$	157.7 ksi	157.7 ksi
layer 4	$f_{pe} =$	157.7 ksi	157.7 ksi
layer 5	$f_{pe} =$	157.7 ksi	
layer 6	$f_{pe} =$	157.7 ksi	
layer 7	$f_{pe} =$	157.7 ksi	
layer 8	$f_{pe} =$	157.7 ksi	
layer 9	$f_{pe} =$		157.7 ksi
layer 10	$f_{pe} =$		157.7 ksi
layer 11	$f_{pe} =$		157.7 ksi
layer 12	$f_{pe} =$		157.7 ksi
layer 13	$f_{pe} =$		157.7 ksi
layer 14	$f_{pe} =$		157.7 ksi

check prestressing stress limit at service limit state:  $f_{pe} \leq 0.8 \cdot f_{py}$

layer 1	=	199.7 ksi
layer 2	=	199.7 ksi
layer 3	=	199.7 ksi
layer 4	=	199.7 ksi
layer 5	=	199.7 ksi
layer 6	=	199.7 ksi
layer 7	=	199.7 ksi
layer 8	=	199.7 ksi
layer 9	=	199.7 ksi
layer 10	=	199.7 ksi
layer 11	=	199.7 ksi
layer 12	=	199.7 ksi
layer 13	=	199.7 ksi
layer 14	=	199.7 ksi

OK  
OK  
OK  
OK  
OK  
OK  
OK  
OK  
OK  
OK  
OK  
OK  
OK  
OK

force per strand =  $f_{pe} \cdot \text{strand area}$

		at midspan	at endspan
layer 1	=	24.1 kips	24.1 kips
layer 2	=	24.1 kips	24.1 kips
layer 3	=	24.1 kips	24.1 kips
layer 4	=	24.1 kips	24.1 kips
layer 5	=	24.1 kips	
layer 6	=	24.1 kips	
layer 7	=	24.1 kips	
layer 8	=	24.1 kips	
layer 9	=		24.1 kips
layer 10	=		24.1 kips
layer 11	=		24.1 kips
layer 12	=		24.1 kips
layer 13	=		24.1 kips
layer 14	=		24.1 kips

		at midspan	at endspan
Total prestressing force after all losses	$P_{pe} =$	1061.6 kips	1061.6 kips
Final losses, % = $(\Delta f_{PT})/f_{pi}$			
layer 1	% =	24.0%	24.0%
layer 2	% =	24.0%	24.0%
layer 3	% =	24.0%	24.0%
layer 4	% =	24.0%	24.0%
layer 5	% =	24.0%	
layer 6	% =	24.0%	
layer 7	% =	24.0%	
layer 8	% =	24.0%	
layer 9	% =		24.0%
layer 10	% =		24.0%
layer 11	% =		24.0%
layer 12	% =		24.0%
layer 13	% =		24.0%
layer 14	% =		24.0%
Average final losses, %	% =	24.0%	24.0%

### Stresses at Transfer

#### STRESS LIMITS FOR CONCRETE

Compression = $0.6f_{ci}$	$f_{ci} =$	3.300 ksi
Tension		
without bonded reinforcement = $-0.0948\sqrt{f_{ci}} \leq -0.2$	=	-0.200 ksi
with bonded auxiliary reinforcement = $-0.22\sqrt{f_{ci}}$	=	-0.016 ksi

#### STRESSES AT TRANSFER LENGTH SECTION

Transfer Length = $60 \times (\text{strand diameter})$	=	2.5 ft	} Calcs for eccentricity (see 9.6.7.2)
Bending moment at transfer length	$M_D =$	116.4 ft-kips	
center of 12 strands to top fiber of beam at the end	=	7.00 in	
center of 12 strands to bottom fiber of beam at the harp point	=	11.00 in	
center of 12 strands and top fiber of beam at transfer length	=	10.78 in	
center of gravity of 32 strands and bottom fiber of beam	=	3.88 in	
center of gravity of all strands and the bottom fiber of beam at transfer length	=	19.51 in	
center of gravity of all strands and the bottom fiber of beam at the end	=	20.55 in	
Eccentricity of the strand group at transfer length:	$e_n =$	17.09 in	}
Eccentricity at end of beam:	$e =$	16.05 in	

$$f_t = \frac{P_i}{A} - \frac{P_{is}}{S_t} + \frac{M_D}{S_t}$$

$$f_b = \frac{P_i}{A} + \frac{P_{is}}{S_b} - \frac{M_D}{S_b}$$

		at midspan	at endspan	
Top stress at top fiber of beam	$f_t =$	0.342 ksi	0.342 ksi	OK
Bottom stress at bottom fiber of the beam	$f_b =$	3.021 ksi	3.021 ksi	OK

#### STRESSES AT HARP POINT

Bending moment due to beam weight at 0.3L	$M_D =$	1184.2 ft-kips		
Top stress at top fiber of beam	$f_t =$	0.032 ksi	0.032 ksi	OK
Bottom stress at bottom fiber of the beam	$f_b =$	3.300 ksi	3.300 ksi	OK

#### STRESSES AT MIDSPAN

Bending moment due to beam weight at 0.5L	$M_D =$	1414.3 ft-kips		
Top stress at top fiber of beam	$f_t =$	0.220 ksi	0.211 ksi	OK
Bottom stress at bottom fiber of the beam	$f_b =$	3.144 ksi	3.189 ksi	OK

#### HOLD-DOWN FORCES

assume stress in strand before losses =  $0.8f_u$

layer 1	=	221.4 ksi
layer 2	=	221.4 ksi
layer 3	=	221.4 ksi
layer 4	=	221.4 ksi
layer 5	=	221.4 ksi
layer 6	=	221.4 ksi
layer 7	=	221.4 ksi
layer 8	=	221.4 ksi
layer 9	=	221.4 ksi
layer 10	=	221.4 ksi
layer 11	=	221.4 ksi
layer 12	=	221.4 ksi
layer 13	=	221.4 ksi
layer 14	=	221.4 ksi

prestress force per strand before any losses:

layer 1	=	33.9 kips
layer 2	=	33.9 kips
layer 3	=	33.9 kips
layer 4	=	33.9 kips
layer 5	=	33.9 kips
layer 6	=	33.9 kips
layer 7	=	33.9 kips
layer 8	=	33.9 kips
layer 9	=	33.9 kips
layer 10	=	33.9 kips
layer 11	=	33.9 kips
layer 12	=	33.9 kips
layer 13	=	33.9 kips
layer 14	=	33.9 kips
Harp Angle	$\psi =$	7.2 °

Hold-down force/strand

layer 1	=	4.4 kips/strand
layer 2	=	4.4 kips/strand
layer 3	=	4.4 kips/strand
layer 4	=	4.4 kips/strand
layer 5	=	4.4 kips/strand
layer 6	=	4.4 kips/strand
layer 7	=	4.4 kips/strand
layer 8	=	4.4 kips/strand
layer 9	=	4.4 kips/strand
layer 10	=	4.4 kips/strand
layer 11	=	4.4 kips/strand
layer 12	=	4.4 kips/strand
layer 13	=	4.4 kips/strand
layer 14	=	4.4 kips/strand
Total hold-down force	=	53.39 kips

### Stresses at Service Loads

#### STRESS LIMITS FOR CONCRETE

Compression:

Due to permanent loads for load combination Service I

for the precast beam	=	3.150 ksi
for deck	=	1.800 ksi

Due to permanent and transient loads for load combination Service I

for the precast beam	=	4.200 ksi
for deck	=	2.400 ksi

Tension:

Load Combination Service III

for the precast beam	=	-0.016 ksi
----------------------	---	------------

#### STRESSES AT MIDSPAN

Compression stresses at top fiber of beam	at midspan	at endspan	
$f_t = \frac{P_{pe}}{A} - \frac{P_{pe}e}{S_t} + \frac{(M_D + M_L)}{S_t} + \frac{(M_{ws} + M_b)}{S_{tr}}$			
Due to permanent loads	$f_{t0} =$	2.041 ksi	2.041 ksi
$f_{tr} = \frac{P_{pe}}{A} - \frac{P_{pe}e}{S_t} + \frac{(M_D + M_L)}{S_t} + \frac{(M_{ws} + M_b)}{S_{tr}} + \frac{(M_{LL+I})}{S_{tr}}$			
Due to permanent loads and transient loads	$f_{t0} =$	2.444 ksi	2.444 ksi
Compression stresses at top fiber of deck	at midspan	at endspan	
$f_{tc} = \frac{(M_{ws} + M_b)}{S_{tr}}$			
Due to permanent loads	$f_{tc} =$	0.042 ksi	0.042 ksi
$f_{tr} = \frac{(M_{ws} + M_b + M_{LL+I})}{S_{tr}}$			
Due to permanent loads and transient loads	$f_{tc} =$	0.488 ksi	0.488 ksi
Tension stresses at top fiber of deck	at midspan	at endspan	
$f_{tr} = \frac{P_{pe}}{A} + \frac{P_{pe}e}{S_t} - \frac{(M_D + M_L)}{S_b} - \frac{(M_{ws} + M_b + 0.8 * M_{LL+I})}{S_{tr}}$			
Load Combination Service III	$f_b =$	-0.393 ksi	-0.393 ksi

OK

OK

OK

OK

OK

**Strength Limit State**

POSITIVE MOMENT SECTION		
$M_u = 1.25DC+1.5DW+1.75(LL+IM)$	$M_u =$	8381.5 ft-kips
effective length factor for compression members		
layer 1	k =	0.28
layer 2	k =	0.28
layer 3	k =	0.28
layer 4	k =	0.28
layer 5	k =	0.28
layer 6	k =	0.28
layer 7	k =	0.28
layer 8	k =	0.28
layer 9	k =	0.28
layer 10	k =	0.28
layer 11	k =	0.28
layer 12	k =	0.28
layer 13	k =	0.28
layer 14	k =	0.28
	c =	5.7 ft-kips
average stress in prestressing steel		
layer 1	$f_{ps} =$	270.9 ksi
layer 2	$f_{ps} =$	270.9 ksi
layer 3	$f_{ps} =$	270.9 ksi
layer 4	$f_{ps} =$	270.9 ksi
layer 5	$f_{ps} =$	270.9 ksi
layer 6	$f_{ps} =$	270.9 ksi
layer 7	$f_{ps} =$	270.9 ksi
layer 8	$f_{ps} =$	270.9 ksi
layer 9	$f_{ps} =$	270.9 ksi
layer 10	$f_{ps} =$	270.9 ksi
layer 11	$f_{ps} =$	270.9 ksi
layer 12	$f_{ps} =$	270.9 ksi
layer 13	$f_{ps} =$	270.9 ksi
layer 14	$f_{ps} =$	270.9 ksi
nominal flexure resistance		
	a =	4.85 in
$M_r = \Phi M_n, \Phi = 1.00$	$\Phi M_n =$	10906.2 ft-kips
M=DC+W+LL+IM	M =	5833.6 ft-kips
NEGATIVE MOMENT SECTION		
$M_u = 1.25DC+1.5DW+1.75(LL+IM)$	$M_u =$	-4837.2 ft-kips
	a =	5.97 in
	$\Phi M_n =$	4905.9 ft-kips
M=DC+W+LL+IM	M =	-2869.7 ft-kips

OK  
OK

OK  
OK

**Shear Design**

CRITICAL SECTION AT 0.59		
$V_u = 1.25DC+1.5DW+1.75(LL+IM)$	$V_u =$	405.0 kips
$M_u = 1.25DC+1.5DW+1.75(LL+IM)$	$M_u =$	-2684.4 ft-kips
or		
$V_u = 1.25DC+1.5DW+1.75(LL+IM)$	$V_u =$	364.8 kips
$M_u = 1.25DC+1.5DW+1.75(LL+IM)$	$M_u =$	-2877.0 ft-kips
max shear	$V_u =$	405.0 kips
max moment	$M_u =$	2877.0 ft-kips
Shear depth	$d_v =$	73.19 in
Applied factored normal force at the section	$N_u =$	0
Angle of diagonal compressive stresses	$\theta =$	36.00 °



### STRAIN IN FLEXURAL TENSION REINFORCEMENT

$$\epsilon_x = \frac{\frac{M}{d_v} + 0.5N_u + 0.5P_u \cot \theta - A_{ps}f_{po}}{E_s A_s + E_p A_{ps}} \leq 0.002$$

	at midspan	at endspan
resultant compressive stress at centroid $f_{pc} =$	0.994 ksi	0.994 ksi
effective stress in prestressing strand after all losses		
layer 1 $f_{po} =$	162.8 ksi	162.8 ksi
layer 2 $f_{po} =$	162.8 ksi	162.8 ksi
layer 3 $f_{po} =$	162.8 ksi	162.8 ksi
layer 4 $f_{po} =$	162.8 ksi	162.8 ksi
layer 5 $f_{po} =$	162.8 ksi	
layer 6 $f_{po} =$	162.8 ksi	
layer 7 $f_{po} =$	162.8 ksi	
layer 8 $f_{po} =$	162.8 ksi	
layer 9 $f_{po} =$		162.8 ksi
layer 10 $f_{po} =$		162.8 ksi
layer 11 $f_{po} =$		162.8 ksi
layer 12 $f_{po} =$		162.8 ksi
layer 13 $f_{po} =$		162.8 ksi
layer 14 $f_{po} =$		162.8 ksi

	at midspan	at endspan
strain in flexural tension		
layer 1 $\epsilon_x =$	0.002000	0.002000
layer 2 $\epsilon_x =$	0.002000	0.002000
layer 3 $\epsilon_x =$	0.002000	0.002000
layer 4 $\epsilon_x =$	0.002000	0.002000
layer 5 $\epsilon_x =$	0.002000	
layer 6 $\epsilon_x =$	0.002000	
layer 7 $\epsilon_x =$	0.002000	
layer 8 $\epsilon_x =$	0.002000	
layer 9 $\epsilon_x =$		0.002000
layer 10 $\epsilon_x =$		0.002000
layer 11 $\epsilon_x =$		0.002000
layer 12 $\epsilon_x =$		0.002000
layer 13 $\epsilon_x =$		0.002000
layer 14 $\epsilon_x =$		0.002000

### Deflection and Camber

	at midspan	at endspan
Deflection due to Prestressing Force at Transfer $\Delta_p =$	3.97 in	3.97 in
Deflection due to Beam Self-Weight at Transfer $\Delta_g =$	-1.49 in	
Deflection due to Beam Self-Weight at Erection $\Delta_g =$	-1.44 in	
Deflection due to Haunch and Deck $\Delta_g =$	-1.95 in	
Deflection due to total self weight $\Delta_{sw} =$	0.59 in	
Total Deflection at transfer $\Delta =$	2.48 in	2.48 in
Total Deflection at erection $\Delta =$	4.49 in	4.49 in
Live load deflection limit = span/800 = $\Delta_L =$	1.80 in	
Deflection due to live load and impact $\Delta_L =$	-0.83 in	
Deflection due to fire truck $\Delta_L =$	-0.7520 in	
Total Deflection after fire with fire truck $\Delta =$	3.8033 in	

OK

OK

**Location: Fire at Critical Negative Moment Sections**  
**Beam Design: 1/2" Strand**  
**Fire Exposure Status: 1/2 Hour**

(PCI Bridge Design Manual Section 9.6)



**Material Properties**

CAST-IN-PLACE SLAB		
Actual Thickness	$t_{as} =$	8.0 in
Wearing Surface	=	0.5 in
Structural thickness = Actual - Wearing Surface	$t_s =$	7.5 in
Compressive Strength	$f_c =$	3.74 ksi
Unit Weight	$w_c =$	150.0 pcf
Stress factor of compression block	$\beta_1 =$	0.85

BEAMS: AASHTO-PCI, BT-72 BULB-TEE		
Strength at release	$f_{ci} =$	5.5 ksi
Strength at 28 days	$f_c =$	7 ksi
Unit Weight	$w_c =$	150.0 pcf
Overall Beam Length:		
@ end spans	L =	110 ft
@ center span	L =	119 ft
Design Spans:		
Non-composite beam @ end spans	L =	109 ft
Non-composite beam @ center span	L =	118 ft
Composite beam @ end spans	L =	110 ft
Composite beam @ center span	L =	120 ft
Beam Spacing	S =	12 ft



**PRESTRESSING STRANDS**

Diameter of single strand	d =	0.5 in
Area of single strand	A =	0.153 in <sup>2</sup>

Temperature of Layer	layer 1 (bottom)	T =	68.00 °F
	layer 2	T =	68.00 °F
	layer 3	T =	68.00 °F
	layer 4	T =	68.00 °F
	layer 5	T =	68.00 °F
	layer 6	T =	68.00 °F
	layer 7	T =	68.00 °F
	layer 8	T =	68.00 °F
	layer 9	T =	68.00 °F
	layer 10	T =	68.00 °F
	layer 11	T =	68.00 °F
	layer 12	T =	68.00 °F
	layer 13	T =	68.00 °F
	layer 14	T =	68.00 °F

Ultimate Strength initial = 277 ksi	layer 1 (bottom)	$f_{pu}$ =	277 ksi
	layer 2	$f_{pu}$ =	277 ksi
	layer 3	$f_{pu}$ =	277 ksi
	layer 4	$f_{pu}$ =	277 ksi
	layer 5	$f_{pu}$ =	277 ksi
	layer 6	$f_{pu}$ =	277 ksi
	layer 7	$f_{pu}$ =	277 ksi
	layer 8	$f_{pu}$ =	277 ksi
	layer 9	$f_{pu}$ =	277 ksi
	layer 10	$f_{pu}$ =	277 ksi
	layer 11	$f_{pu}$ =	277 ksi
	layer 12	$f_{pu}$ =	277 ksi
	layer 13	$f_{pu}$ =	277 ksi
	layer 14	$f_{pu}$ =	277 ksi

Yield Strength initial = 250 ksi	layer 1 (bottom)	$f_{py}$ =	250 ksi
	layer 2	$f_{py}$ =	250 ksi
	layer 3	$f_{py}$ =	250 ksi
	layer 4	$f_{py}$ =	250 ksi
	layer 5	$f_{py}$ =	250 ksi
	layer 6	$f_{py}$ =	250 ksi
	layer 7	$f_{py}$ =	250 ksi
	layer 8	$f_{py}$ =	250 ksi
	layer 9	$f_{py}$ =	250 ksi
	layer 10	$f_{py}$ =	250 ksi
	layer 11	$f_{py}$ =	250 ksi
	layer 12	$f_{py}$ =	250 ksi
	layer 13	$f_{py}$ =	250 ksi
	layer 14	$f_{py}$ =	250 ksi

<b>Stress Limits:</b> before transfer $\leq 0.75f_{pu}$ (initial = 207.6)	layer 1 (bottom)	$f_{pi}$ =	207.6 ksi
	layer 2	$f_{pi}$ =	207.6 ksi
	layer 3	$f_{pi}$ =	207.6 ksi
	layer 4	$f_{pi}$ =	207.6 ksi
	layer 5	$f_{pi}$ =	207.6 ksi
	layer 6	$f_{pi}$ =	207.6 ksi
	layer 7	$f_{pi}$ =	207.6 ksi
	layer 8	$f_{pi}$ =	207.6 ksi
	layer 9	$f_{pi}$ =	207.6 ksi
	layer 10	$f_{pi}$ =	207.6 ksi
	layer 11	$f_{pi}$ =	207.6 ksi
	layer 12	$f_{pi}$ =	207.6 ksi
	layer 13	$f_{pi}$ =	207.6 ksi
	layer 14	$f_{pi}$ =	207.6 ksi

at service limit state (after all losses)  $\leq 0.80f_{py}$  (initial = 199.7)

layer 1 (bottom)	$f_{pe} =$	199.7 ksi
layer 2	$f_{pe} =$	199.7 ksi
layer 3	$f_{pe} =$	199.7 ksi
layer 4	$f_{pe} =$	199.7 ksi
layer 5	$f_{pe} =$	199.7 ksi
layer 6	$f_{pe} =$	199.7 ksi
layer 7	$f_{pe} =$	199.7 ksi
layer 8	$f_{pe} =$	199.7 ksi
layer 9	$f_{pe} =$	199.7 ksi
layer 10	$f_{pe} =$	199.7 ksi
layer 11	$f_{pe} =$	199.7 ksi
layer 12	$f_{pe} =$	199.7 ksi
layer 13	$f_{pe} =$	199.7 ksi
layer 14	$f_{pe} =$	199.7 ksi

Modulus of Elasticity

initial = 25982 ksi

layer 1 (bottom)	E =	25982.0 ksi
layer 2	E =	25982.0 ksi
layer 3	E =	25982.0 ksi
layer 4	E =	25982.0 ksi
layer 5	E =	25982.0 ksi
layer 6	E =	25982.0 ksi
layer 7	E =	25982.0 ksi
layer 8	E =	25982.0 ksi
layer 9	E =	25982.0 ksi
layer 10	E =	25982.0 ksi
layer 11	E =	25982.0 ksi
layer 12	E =	25982.0 ksi
layer 13	E =	25982.0 ksi
layer 14	E =	25982.0 ksi

### MILD STEEL REINFORCING BARS

Yield Strength

Layer 1 (Bottom)	$f_y =$	60.0 ksi	68.00 °F
Layer 2 (Top)	$f_y =$	58.2 ksi	550.00 °F

Modulus of Elasticity

E =	29000.0 ksi
-----	-------------

Layer 1 (Bottom)

Area of steel at midspan (effective flange)	$A_{sm} =$	2.79 in <sup>2</sup>
Area of steel at endspan (effective flange)	$A_{se} =$	2.48 in <sup>2</sup>
Area of temperature and shrinkage steel (12" width)	$A_s =$	0.31 in <sup>2</sup>

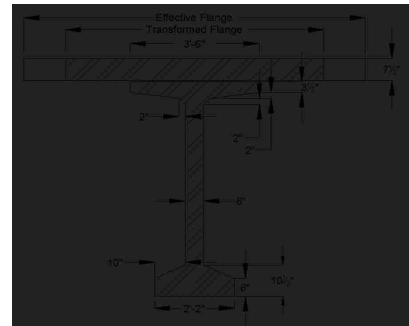
Layer 2 (Top)

Area of steel at midspan (effective flange)	$A_{sm} =$	12.6 in <sup>2</sup>
Area of steel at endspan (effective flange)	$A_{se} =$	12.4 in <sup>2</sup>
Area of temperature and shrinkage steel (12" width)	$A_s =$	0.2 in <sup>2</sup>

### Cross-sectional Properties

#### NON-COMPOSITE BEAM

Area of cross-section of beam	A =	767.0 in <sup>2</sup>
Overall depth of beam	H =	72.0 in
Moment of Inertia	I =	539,947 in <sup>4</sup>
Distance from centroid to extreme bottom fiber	$y_b =$	36.6 in
Distance from centroid to extreme top fiber	$y_t =$	35.4 in
Section modulus for the extreme bottom fiber	$S_b =$	14915.0 in <sup>3</sup>
Section modulus for the extreme top fiber	$S_t =$	15421.0 in <sup>3</sup>
Weight	$W_1 =$	799.0 plf
Modulus of Elasticity = $33000 \cdot (W_c^{1.5}) \cdot (\sqrt{f_c})$		
cast-in-place concrete deck	$E_{cp} =$	3708 ksi
precast beam at release	$E_{ci} =$	4496 ksi
precast beam at service loads	$E_c =$	5072 ksi



### COMPOSITE BEAM AT MIDSPAN

Effective Flange Width	$b_f =$	111.0 in	*min of three criteria
Modular Ratio = $E_{cf}/E_c$	$n =$	0.7309	
Transformed flange width	$=$	81.1 in	
Transformed flange area	$=$	608.5 in <sup>2</sup>	
Transformed haunch width	$=$	30.7 in	
Transformed haunch area	$=$	15.3 in <sup>2</sup>	
Deck-distance to top fiber	$y_t =$	4.56 in	

	Transformed Area	$y_b$	$Ay_b$	$A(y_{bc}-y_b)^2$	$I$	$I + A(y_{bc}-y_b)^2$
Beam	767.0 in <sup>2</sup>	36.60 in	28,072.2 in <sup>3</sup>	231,850 in <sup>4</sup>	539,947 in <sup>4</sup>	771,797 in <sup>4</sup>
Haunch	15.3 in <sup>2</sup>	72.25 in	1,109.0 in <sup>3</sup>	5,120 in <sup>4</sup>	0.33 in <sup>4</sup>	5,121 in <sup>4</sup>
Deck	608.5 in <sup>2</sup>	75.44 in	45,906.3 in <sup>3</sup>	280,077 in <sup>4</sup>	2,268 in <sup>4</sup>	282,345 in <sup>4</sup>
Total	1390.9 in <sup>2</sup>		75,087.6 in <sup>3</sup>			1,059,263 in <sup>4</sup>

Total area of Composite Section	$A_c =$	1391 in <sup>2</sup>
Overall Depth of the Composite Section	$h_c =$	80 in
Moment of Inertia	$I_c =$	1,059,263 in <sup>4</sup>
Distance from centroid to extreme <u>bottom</u> fiber of beam	$y_{bc} =$	53.99 in
Distance from centroid to extreme <u>top</u> fiber of beam	$y_{tg} =$	18.01 in
Distance from centroid to extreme <u>top</u> fiber of slab	$y_{tc} =$	26.01 in
Section modulus for the extreme <u>bottom</u> fiber of beam	$S_{bc} =$	19,621.0 in <sup>3</sup>
Section modulus for the extreme <u>top</u> fiber of beam	$S_{tg} =$	58,803.0 in <sup>3</sup>
Section modulus for the extreme <u>top</u> fiber slab	$S_{tc} =$	55,707.6 in <sup>3</sup>

### COMPOSITE BEAM AT ENDSpan

Effective Flange Width	$b_f =$	106.6 in	*min of three criteria
Modular Ratio = $E_{cf}/E_c$	$n =$	0.7309	
Transformed flange width	$=$	77.9 in	
Transformed flange area	$=$	584.4 in <sup>2</sup>	
Transformed haunch width	$=$	30.7 in	
Transformed haunch area	$=$	15.3 in <sup>2</sup>	
Deck-distance to top fiber	$y_{td} =$	4.56 in	

	Transformed Area	$y_t$	$Ay_t$	$A(y_{tc}-y_t)^2$	$I$	$I + A(y_{tc}-y_t)^2$
Beam	767.0 in <sup>2</sup>	36.60 in	28,072.2 in <sup>3</sup>	273,989 in <sup>4</sup>	539,947 in <sup>4</sup>	813,936 in <sup>4</sup>
Haunch	15.3 in <sup>2</sup>	72.25 in	1,109.0 in <sup>3</sup>	5,483 in <sup>4</sup>	0.32 in <sup>4</sup>	5,484 in <sup>4</sup>
Deck	584.4 in <sup>2</sup>	77.06 in	45,033.3 in <sup>3</sup>	208,758 in <sup>4</sup>	2,182 in <sup>4</sup>	210,940 in <sup>4</sup>
Total	1366.7 in <sup>2</sup>		74,214.6 in <sup>3</sup>			1,030,360 in <sup>4</sup>

Total area of Composite Section	$A_c =$	1367 in <sup>2</sup>
Overall Depth of the Composite Section	$h_c =$	80 in
Moment of Inertia	$I_c =$	1,030,360 in <sup>4</sup>
Distance from centroid to extreme <u>bottom</u> fiber of beam	$y_{bc} =$	54.30 in
Distance from centroid to extreme <u>top</u> fiber of beam	$y_{tg} =$	17.70 in
Distance from centroid to extreme <u>top</u> fiber of slab	$y_{tc} =$	25.70 in
Section modulus for the extreme <u>bottom</u> fiber of beam	$S_{bc} =$	18,975.2 in <sup>3</sup>
Section modulus for the extreme <u>top</u> fiber of beam	$S_{tg} =$	58,213.4 in <sup>3</sup>
Section modulus for the extreme <u>top</u> fiber slab	$S_{tc} =$	40,092.3 in <sup>3</sup>

### Shear Forces and Bending Moments

#### DEAD LOADS

Beam self-weight	$W_{beam} =$	0.799 k/f
8 in. deck weight	$W_{deck} =$	1.200 k/f
1/2 in. haunch weight	$W_{haunch} =$	0.022 k/f

#### LRFD Specifications: Art. 4.6.2.2.1

Width of Deck Constant		OK
Number of beams is not less than four $N_b =$	4	OK
Roadway part of the overhang, $d_o \leq 3.0$ ft, $d_o =$	1.5	OK
Curvature in plans is less than $4^\circ =$	0	OK
Cross-section of the bridge is consistent with one of the cross sections given by LRFD specs		OK

Barrier and wearing surface loads are equally distributed among the 4 beams

Barrier Wt	$W_t =$	0.150 k/f
Dead load of future wearing surface	$DW =$	0.263 k/f

LIVE LOADS		
Fire truck live load front load (Point A)	$P_{live} =$	48.0 kips
Fire truck live load back load (Point B)	$P_{live} =$	22.0 kips
distance between two loads		19.2 ft
distance from nearest edge to point A	$x_a =$	59.0 ft
distance from nearest edge to point B	$x_b =$	39.8 ft
LRFD Specifications: Art. 4.6.2.2.1		
Width of Deck Constant		OK
Number of beams is not less than four $N_b =$	4	OK
Beams are parallel and approximately of the same stiffness		OK
Roadway part of the overhang, $d_o \leq 3.0$ ft, $d_o =$	1.5	OK
Curvature in plans is less than $4^\circ =$	0	OK

Barrier and wearing surface loads are equally distributed among the 4 beams

Bridge Type-- "k" (LRFD Table 4.6.2.2.1-1)

Number of design lanes = w/12	=	3 lanes
-------------------------------	---	---------

**Distribution Factor for Bending Moment:**

Beams spacing	$S =$	12.0 ft
Depth of concrete slab	$t_s =$	7.5 in
Beam Span	$L =$	120.0 ft
Number of Beams	$N_b =$	4
Modular ratio between beam & deck materials	$n =$	1.3681
Longitudinal stiffness parameter	$K_B =$	2,388,355.61 in <sup>4</sup>

at center span:

$$DFM = 0.75 + \left(\frac{S}{9.5}\right)^{0.6} * \left(\frac{S}{L}\right)^{0.2} * \left(\frac{K_B}{12 * L * t_s^3}\right)^{0.1}$$

DFM =	0.907 lanes/beam
-------	------------------

0.905 Controls

one design lane loaded:

$$DFM = 0.75 + \left(\frac{S}{14}\right)^{0.4} * \left(\frac{S}{L}\right)^{0.2} * \left(\frac{K_B}{12 * L * t_s^3}\right)^{0.1}$$

DFM =	0.615 lanes/beam
-------	------------------

**Distribution Factor for Shear Force**

both end spans and center span:

$$DFV = 0.2 + \left(\frac{S}{12}\right) - \left(\frac{S}{35}\right)^2$$

DFV =	1.082 lanes/beam
-------	------------------

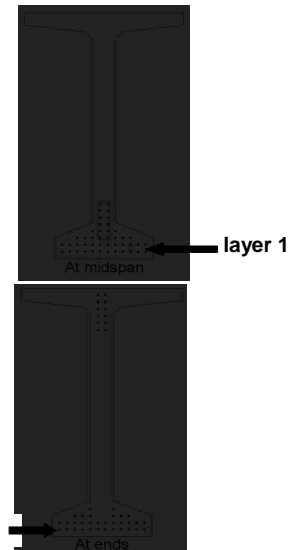
1.082 Controls

one design lane loaded:

$$DFV = 0.36 + \left(\frac{S}{25}\right)$$

DFV =	0.840 lanes/beam
-------	------------------

	At Midspan		At Ends	
from bottom	No. of	Distance from Bottom	No. of	Distance from Bottom
layer 1	12	2	12	2
layer 2	12	4	12	4
layer 3	8	6	6	6
layer 4	4	8	2	8
layer 5	2	10	-	-
layer 6	2	12	-	-
layer 7	2	14	-	-
layer 8	2	16	-	-
layer 9	-	-	2	60
layer 10	-	-	2	62
layer 11	-	-	2	64
layer 12	-	-	2	66
layer 13	-	-	2	68
layer 14	-	-	2	70
<b>Harped Strand Group (included in above totals)</b>				
layer 3	2	6		
layer 4	2	8		
layer 5	2	10		
layer 6	2	12		
layer 7	2	14		
layer 8	2	16		



distance from the center of gravity of strands to the bottom fiber of the beam = 7% of the beam depth	$y_{bs} =$	5.82 in
strand eccentricity at midspan = $(y_c - y_{bs})$	$e_c =$	30.78 in

**Prestress Losses**

**ELASTIC SHORTENING**

assumed loss	=	9.00%
Force per strand at transfer		
layer 1	=	28.9 kips
layer 2	=	28.9 kips
layer 3	=	28.9 kips
layer 4	=	28.9 kips
layer 5	=	28.9 kips
layer 6	=	28.9 kips
layer 7	=	28.9 kips
layer 8	=	28.9 kips
layer 9	=	28.9 kips
layer 10	=	28.9 kips
layer 11	=	28.9 kips
layer 12	=	28.9 kips
layer 13	=	28.9 kips
layer 14	=	28.9 kips
		<b>at midspan</b>
		<b>at endspan</b>
Total prestressing force at release	$P_i =$	1271.6 kips
		1271.6 kips
Sum of concrete stresses at the center of gravity of prestressing tendons due to prestressing force at transfer and the self-weight of the member at sections of maximum moment	$f_{cgp} =$	2.938 ksi
		2.938 ksi
		<b>at midspan</b>
		<b>at endspan</b>
Loss due to shortening		
layer 1	$\Delta f_{PES} =$	17.0 ksi
layer 2	$\Delta f_{PES} =$	17.0 ksi
layer 3	$\Delta f_{PES} =$	17.0 ksi
layer 4	$\Delta f_{PES} =$	17.0 ksi
layer 5	$\Delta f_{PES} =$	17.0 ksi
layer 6	$\Delta f_{PES} =$	17.0 ksi
layer 7	$\Delta f_{PES} =$	17.0 ksi
layer 8	$\Delta f_{PES} =$	17.0 ksi
layer 9	$\Delta f_{PES} =$	17.0 ksi
layer 10	$\Delta f_{PES} =$	17.0 ksi
layer 11	$\Delta f_{PES} =$	17.0 ksi
layer 12	$\Delta f_{PES} =$	17.0 ksi
layer 13	$\Delta f_{PES} =$	17.0 ksi
layer 14	$\Delta f_{PES} =$	17.0 ksi

**SHRINKAGE**

Shrinkage = (17-0.15*Relative Humidity)	$\Delta f_{PSR} =$	6.5 ksi	← assume relative humidity = 70%
---	--------------------	---------	----------------------------------

**CREEP OF CONCRETE**

Change of stresses at center of gravity of prestressing due to permanent loads except the loads acting at time of applying prestressing force, calculated at the same section as $f_{cgp}$	$\Delta f_{cdp} =$	1.565 ksi
		<b>at midspan</b>
		<b>at endspan</b>
loss due to creep	$\Delta f_{PCR} =$	24.3 ksi
		24.3 ksi

**RELAXATION OF PRESTRESSING STRANDS**

loss due to relaxation after transfer		<b>at midspan</b>	<b>at endspan</b>
layer 1	$\Delta f_{PR2} =$	2.1 ksi	2.1 ksi
layer 2	$\Delta f_{PR2} =$	2.1 ksi	2.1 ksi
layer 3	$\Delta f_{PR2} =$	2.1 ksi	2.1 ksi
layer 4	$\Delta f_{PR2} =$	2.1 ksi	2.1 ksi
layer 5	$\Delta f_{PR2} =$	2.1 ksi	
layer 6	$\Delta f_{PR2} =$	2.1 ksi	
layer 7	$\Delta f_{PR2} =$	2.1 ksi	
layer 8	$\Delta f_{PR2} =$	2.1 ksi	
layer 9	$\Delta f_{PR2} =$		2.1 ksi
layer 10	$\Delta f_{PR2} =$		2.1 ksi
layer 11	$\Delta f_{PR2} =$		2.1 ksi
layer 12	$\Delta f_{PR2} =$		2.1 ksi
layer 13	$\Delta f_{PR2} =$		2.1 ksi
layer 14	$\Delta f_{PR2} =$		2.1 ksi

**TOTAL LOSSES AT TRANSFER**

total loss  $\Delta f_{pES} = \Delta f_{pi}$

stress in tendons after transfer  $f_{pi} = f_{pr} - \Delta f_{pi}$

		at midspan	at endspan
layer 1	$f_{pi} =$	190.6 ksi	190.6 ksi
layer 2	$f_{pi} =$	190.6 ksi	190.6 ksi
layer 3	$f_{pi} =$	190.6 ksi	190.6 ksi
layer 4	$f_{pi} =$	190.6 ksi	190.6 ksi
layer 5	$f_{pi} =$	190.6 ksi	
layer 6	$f_{pi} =$	190.6 ksi	
layer 7	$f_{pi} =$	190.6 ksi	
layer 8	$f_{pi} =$	190.6 ksi	
layer 9	$f_{pi} =$		190.6 ksi
layer 10	$f_{pi} =$		190.6 ksi
layer 11	$f_{pi} =$		190.6 ksi
layer 12	$f_{pi} =$		190.6 ksi
layer 13	$f_{pi} =$		190.6 ksi
layer 14	$f_{pi} =$		190.6 ksi

force per strand =  $f_{pi}$  \* strand area

		at midspan	at endspan
layer 1	=	29.2 kips	29.2 kips
layer 2	=	29.2 kips	29.2 kips
layer 3	=	29.2 kips	29.2 kips
layer 4	=	29.2 kips	29.2 kips
layer 5	=	29.2 kips	
layer 6	=	29.2 kips	
layer 7	=	29.2 kips	
layer 8	=	29.2 kips	
layer 9	=		29.2 kips
layer 10	=		29.2 kips
layer 11	=		29.2 kips
layer 12	=		29.2 kips
layer 13	=		29.2 kips
layer 14	=		29.2 kips
Total prestressing force after transfer	$P_i =$	1284.8 kips	1284.8 kips

Initial loss =  $(\Delta f_{pi}) / (f_{pi})$

		at midspan	at endspan
layer 1	% =	8.2%	8.2%
layer 2	% =	8.2%	8.2%
layer 3	% =	8.2%	8.2%
layer 4	% =	8.2%	8.2%
layer 5	% =	8.2%	
layer 6	% =	8.2%	
layer 7	% =	8.2%	
layer 8	% =	8.2%	
layer 9	% =		8.2%
layer 10	% =		8.2%
layer 11	% =		8.2%
layer 12	% =		8.2%
layer 13	% =		8.2%
layer 14	% =		8.2%

OK  
OK  
OK  
OK  
OK  
OK  
OK  
OK  
OK  
OK  
OK  
OK  
OK  
OK

**TOTAL LOSSES AT SERVICE LOADS**

Total Losses

		at midspan	at endspan
layer 1	$\Delta f_{pT} =$	49.9 ksi	49.9 ksi
layer 2	$\Delta f_{pT} =$	49.9 ksi	49.9 ksi
layer 3	$\Delta f_{pT} =$	49.9 ksi	49.9 ksi
layer 4	$\Delta f_{pT} =$	49.9 ksi	49.9 ksi
layer 5	$\Delta f_{pT} =$	49.9 ksi	
layer 6	$\Delta f_{pT} =$	49.9 ksi	
layer 7	$\Delta f_{pT} =$	49.9 ksi	
layer 8	$\Delta f_{pT} =$	49.9 ksi	
layer 9	$\Delta f_{pT} =$		49.9 ksi
layer 10	$\Delta f_{pT} =$		49.9 ksi
layer 11	$\Delta f_{pT} =$		49.9 ksi
layer 12	$\Delta f_{pT} =$		49.9 ksi
layer 13	$\Delta f_{pT} =$		49.9 ksi
layer 14	$\Delta f_{pT} =$		49.9 ksi



Stress in tendon after all losses =  $f_{pe} - \Delta f_{pt}$

		at midspan	at endspan
layer 1	$f_{pe} =$	157.7 ksi	157.7 ksi
layer 2	$f_{pe} =$	157.7 ksi	157.7 ksi
layer 3	$f_{pe} =$	157.7 ksi	157.7 ksi
layer 4	$f_{pe} =$	157.7 ksi	157.7 ksi
layer 5	$f_{pe} =$	157.7 ksi	
layer 6	$f_{pe} =$	157.7 ksi	
layer 7	$f_{pe} =$	157.7 ksi	
layer 8	$f_{pe} =$	157.7 ksi	
layer 9	$f_{pe} =$		157.7 ksi
layer 10	$f_{pe} =$		157.7 ksi
layer 11	$f_{pe} =$		157.7 ksi
layer 12	$f_{pe} =$		157.7 ksi
layer 13	$f_{pe} =$		157.7 ksi
layer 14	$f_{pe} =$		157.7 ksi

check prestressing stress limit at service limit state:  $f_{pe} \leq 0.8 \cdot f_{py}$

layer 1	=	199.7 ksi
layer 2	=	199.7 ksi
layer 3	=	199.7 ksi
layer 4	=	199.7 ksi
layer 5	=	199.7 ksi
layer 6	=	199.7 ksi
layer 7	=	199.7 ksi
layer 8	=	199.7 ksi
layer 9	=	199.7 ksi
layer 10	=	199.7 ksi
layer 11	=	199.7 ksi
layer 12	=	199.7 ksi
layer 13	=	199.7 ksi
layer 14	=	199.7 ksi

OK  
OK  
OK  
OK  
OK  
OK  
OK  
OK  
OK  
OK  
OK  
OK  
OK  
OK

force per strand =  $f_{pe} \cdot \text{strand area}$

		at midspan	at endspan
layer 1	=	24.1 kips	24.1 kips
layer 2	=	24.1 kips	24.1 kips
layer 3	=	24.1 kips	24.1 kips
layer 4	=	24.1 kips	24.1 kips
layer 5	=	24.1 kips	
layer 6	=	24.1 kips	
layer 7	=	24.1 kips	
layer 8	=	24.1 kips	
layer 9	=		24.1 kips
layer 10	=		24.1 kips
layer 11	=		24.1 kips
layer 12	=		24.1 kips
layer 13	=		24.1 kips
layer 14	=		24.1 kips

Total prestressing force after all losses

		at midspan	at endspan
$P_{pe} =$		1061.7 kips	1061.7 kips

Final losses, % =  $(\Delta f_{pt}) / (f_{pi})$

layer 1	% =	24.0%	24.0%
layer 2	% =	24.0%	24.0%
layer 3	% =	24.0%	24.0%
layer 4	% =	24.0%	24.0%
layer 5	% =	24.0%	
layer 6	% =	24.0%	
layer 7	% =	24.0%	
layer 8	% =	24.0%	
layer 9	% =		24.0%
layer 10	% =		24.0%
layer 11	% =		24.0%
layer 12	% =		24.0%
layer 13	% =		24.0%
layer 14	% =		24.0%
Average final losses, %	% =	24.0%	24.0%

### Stresses at Transfer

#### STRESS LIMITS FOR CONCRETE

Compression = $0.6f_{ci}$	$f_{ci} =$	3.300 ksi
Tension		
without bonded reinforcement = $-0.0948 \sqrt{f_{ci}} \leq -0.2$	=	-0.200 ksi
with bonded auxiliary reinforcement = $-0.22 \sqrt{f_{ci}}$	=	-0.016 ksi

#### STRESSES AT TRANSFER LENGTH SECTION

Transfer Length = $60 \times (\text{strand diameter})$	=	2.5 ft	} Calcs for eccentricity (see 9.6.7.2)
Bending moment at transfer length	$M_g =$	116.4 ft-kips	
center of 12 strands to top fiber of beam at the end	=	7.00 in	
center of 12 strands to bottom fiber of beam at the harp point	=	11.00 in	
center of 12 strands and top fiber of beam at transfer length	=	10.78 in	
center of gravity of 32 strands and bottom fiber of beam	=	3.88 in	
center of gravity of all strands and the bottom fiber of beam at transfer length	=	19.51 in	
center of gravity of all strands and the bottom fiber of beam at the end	=	20.55 in	
Eccentricity of the strand group at transfer length:	$e_n =$	17.09 in	
Eccentricity at end of beam:	$e =$	16.05 in	

$$f_t = \frac{P_i}{A} - \frac{P_i e}{S_t} + \frac{M_g}{S_t} \qquad f_b = \frac{P_i}{A} + \frac{P_i e}{S_b} - \frac{M_g}{S_b}$$

		at midspan	at endspan	
Top stress at top fiber of beam	$f_t =$	0.342 ksi	0.342 ksi	OK
Bottom stress at bottom fiber of the beam	$f_b =$	3.021 ksi	3.021 ksi	OK

#### STRESSES AT HARP POINT

Bending moment due to beam weight at 0.3L	$M_g =$	1188.0 ft-kips		
Top stress at top fiber of beam	$f_t =$	0.035 ksi	0.035 ksi	OK
Bottom stress at bottom fiber of the beam	$f_b =$	3.300 ksi	3.300 ksi	OK

#### STRESSES AT MIDSPAN

Bending moment due to beam weight at 0.5L	$M_g =$	1414.3 ft-kips		
Top stress at top fiber of beam	$f_t =$	0.220 ksi	0.211 ksi	OK
Bottom stress at bottom fiber of the beam	$f_b =$	3.144 ksi	3.189 ksi	OK

#### HOLD-DOWN FORCES

assume stress in strand before losses =  $0.8f_u$

layer 1	=	221.4 ksi
layer 2	=	221.4 ksi
layer 3	=	221.4 ksi
layer 4	=	221.4 ksi
layer 5	=	221.4 ksi
layer 6	=	221.4 ksi
layer 7	=	221.4 ksi
layer 8	=	221.4 ksi
layer 9	=	221.4 ksi
layer 10	=	221.4 ksi
layer 11	=	221.4 ksi
layer 12	=	221.4 ksi
layer 13	=	221.4 ksi
layer 14	=	221.4 ksi

prestress force per strand before any losses:

layer 1	=	33.9 kips
layer 2	=	33.9 kips
layer 3	=	33.9 kips
layer 4	=	33.9 kips
layer 5	=	33.9 kips
layer 6	=	33.9 kips
layer 7	=	33.9 kips
layer 8	=	33.9 kips
layer 9	=	33.9 kips
layer 10	=	33.9 kips
layer 11	=	33.9 kips
layer 12	=	33.9 kips
layer 13	=	33.9 kips
layer 14	=	33.9 kips
Harp Angle	$\psi =$	7.2 °

Hold-down force/strand

layer 1	=	4.4 kips/strand
layer 2	=	4.4 kips/strand
layer 3	=	4.4 kips/strand
layer 4	=	4.4 kips/strand
layer 5	=	4.4 kips/strand
layer 6	=	4.4 kips/strand
layer 7	=	4.4 kips/strand
layer 8	=	4.4 kips/strand
layer 9	=	4.4 kips/strand
layer 10	=	4.4 kips/strand
layer 11	=	4.4 kips/strand
layer 12	=	4.4 kips/strand
layer 13	=	4.4 kips/strand
layer 14	=	4.4 kips/strand
Total hold-down force	=	53.39 kips

**Stresses at Service Loads**

**STRESS LIMITS FOR CONCRETE**

**Compression:**

Due to permanent loads for load combination Service I

for the precast beam	=	3.150 ksi
for deck	=	1.683 ksi

Due to permanent and transient loads for load combination Service I

for the precast beam	=	4.200 ksi
for deck	=	2.244 ksi

**Tension:**

Load Combination Service III

for the precast beam	=	-0.016 ksi
----------------------	---	------------

**STRESSES AT MIDSPAN**

Compression stresses at top fiber of beam	at midspan	at endspan	
$f_t = \frac{P_{ps}}{A} - \frac{P_{ps}e}{S_t} + \frac{(M_p + M_s)}{S_t} + \frac{(M_{ws} + M_d)}{S_{tr}}$			
Due to permanent loads	$f_{t0} =$	2.043 ksi	2.043 ksi
$f_{tr} = \frac{P_{ps}}{A} - \frac{P_{ps}e}{S_t} + \frac{(M_p + M_s)}{S_t} + \frac{(M_{ws} + M_d)}{S_{tr}} + \frac{(M_{LL+I})}{S_{tr}}$			
Due to permanent loads and transient loads	$f_{t0} =$	2.475 ksi	2.475 ksi
<b>Compression stresses at top fiber of deck</b>	<b>at midspan</b>	<b>at endspan</b>	
$f_{tc} = \frac{(M_{ws} + M_d)}{S_{tr}}$			
Due to permanent loads	$f_{tc} =$	0.043 ksi	0.043 ksi
$f_{tc} = \frac{(M_{ws} + M_d + M_{LL+I})}{S_{tr}}$			
Due to permanent loads and transient loads	$f_{tc} =$	0.499 ksi	0.499 ksi
<b>Tension stresses at top fiber of deck</b>	<b>at midspan</b>	<b>at endspan</b>	
$f_{tr} = \frac{P_{ps}}{A} - \frac{P_{ps}e}{S_t} - \frac{(M_p + M_s)}{S_t} - \frac{(M_{ws} + M_d + C.8 * M_{LL+I})}{S_{tr}}$			
Load Combination Service III	$f_{tr} =$	-0.413 ksi	-0.413 ksi

OK

OK

OK

OK

OK

**Strength Limit State**

POSITIVE MOMENT SECTION		
$M_u = 1.25DC+1.5DW+1.75(LL+IM)$	$M_u =$	8381.5 ft-kips

effective length factor for compression members

layer 1	k =	0.28
layer 2	k =	0.28
layer 3	k =	0.28
layer 4	k =	0.28
layer 5	k =	0.28
layer 6	k =	0.28
layer 7	k =	0.28
layer 8	k =	0.28
layer 9	k =	0.28
layer 10	k =	0.28
layer 11	k =	0.28
layer 12	k =	0.28
layer 13	k =	0.28
layer 14	k =	0.28
	c =	6.1 ft-kips

average stress in prestressing steel

layer 1	$f_{ps} =$	270.5 ksi
layer 2	$f_{ps} =$	270.5 ksi
layer 3	$f_{ps} =$	270.5 ksi
layer 4	$f_{ps} =$	270.5 ksi
layer 5	$f_{ps} =$	270.5 ksi
layer 6	$f_{ps} =$	270.5 ksi
layer 7	$f_{ps} =$	270.5 ksi
layer 8	$f_{ps} =$	270.5 ksi
layer 9	$f_{ps} =$	270.5 ksi
layer 10	$f_{ps} =$	270.5 ksi
layer 11	$f_{ps} =$	270.5 ksi
layer 12	$f_{ps} =$	270.5 ksi
layer 13	$f_{ps} =$	270.5 ksi
layer 14	$f_{ps} =$	270.5 ksi

nominal flexure resistance

	a =	5.18 in
$M_r = \Phi M_n, \Phi = 1.00$	$\Phi M_n =$	10865.1 ft-kips
M=DC+W+LL+IM	M =	5833.6 ft-kips

OK  
OK

NEGATIVE MOMENT SECTION		
$M_u = 1.25DC+1.5DW+1.75(LL+IM)$	$M_u =$	-4837.2 ft-kips

	a =	5.82 in
	$\Phi M_n =$	4788.0 ft-kips
M=DC+W+LL+IM	M =	-2869.7 ft-kips

NOT OK  
OK

**Shear Design**

CRITICAL SECTION AT 0.59		
$V_u = 1.25DC+1.5DW+1.75(LL+IM)$	$V_u =$	405.0 kips
$M_u = 1.25DC+1.5DW+1.75(LL+IM)$	$M_u =$	-2684.4 ft-kips

or

$V_u = 1.25DC+1.5DW+1.75(LL+IM)$	$V_u =$	364.8 kips
$M_u = 1.25DC+1.5DW+1.75(LL+IM)$	$M_u =$	-2877.0 ft-kips

max shear	$V_u =$	405.0 kips
max moment	$M_u =$	2877.0 ft-kips
Shear depth	$d_v =$	73.19 in
Applied factored normal force at the section	$N_u =$	0
Angle of diagonal compressive stresses	$\theta =$	36.00 °

**STRAIN IN FLEXURAL TENSION REINFORCEMENT**

$$\epsilon_x = \frac{\frac{M}{d_v} + 0.5N_u + 0.5V_u \cot \theta - A_{ps} f_{ps}}{E_s A_s + E_p A_{ps}} \leq 0.002$$

	<b>at midspan</b>	<b>at endspan</b>
resultant compressive stress at centroid effective stress in prestressing strand after all losses	$f_{pc} =$ 1.008 ksi	1.008 ksi

layer 1	$f_{po} =$	162.9 ksi	162.9 ksi
layer 2	$f_{po} =$	162.9 ksi	162.9 ksi
layer 3	$f_{po} =$	162.9 ksi	162.9 ksi
layer 4	$f_{po} =$	162.9 ksi	162.9 ksi
layer 5	$f_{po} =$	162.9 ksi	
layer 6	$f_{po} =$	162.9 ksi	
layer 7	$f_{po} =$	162.9 ksi	
layer 8	$f_{po} =$	162.9 ksi	
layer 9	$f_{po} =$		162.9 ksi
layer 10	$f_{po} =$		162.9 ksi
layer 11	$f_{po} =$		162.9 ksi
layer 12	$f_{po} =$		162.9 ksi
layer 13	$f_{po} =$		162.9 ksi
layer 14	$f_{po} =$		162.9 ksi

		<b>at midspan</b>	<b>at endspan</b>
strain in flexural tension	layer 1	$\epsilon_x =$ 0.002000	0.002000
	layer 2	$\epsilon_x =$ 0.002000	0.002000
	layer 3	$\epsilon_x =$ 0.002000	0.002000
	layer 4	$\epsilon_x =$ 0.002000	0.002000
	layer 5	$\epsilon_x =$ 0.002000	
	layer 6	$\epsilon_x =$ 0.002000	
	layer 7	$\epsilon_x =$ 0.002000	
	layer 8	$\epsilon_x =$ 0.002000	
	layer 9	$\epsilon_x =$	0.002000
	layer 10	$\epsilon_x =$	0.002000
	layer 11	$\epsilon_x =$	0.002000
	layer 12	$\epsilon_x =$	0.002000
	layer 13	$\epsilon_x =$	0.002000
	layer 14	$\epsilon_x =$	0.002000

**Deflection and Camber**

		<b>at midspan</b>	<b>at endspan</b>
Deflection due to Prestressing Force at Transfer	$\Delta_p =$	3.97 in	3.97 in
Deflection due to Beam Self-Weight at Transfer	$\Delta_g =$	-1.49 in	
Deflection due to Beam Self-Weight at Erection	$\Delta_g =$	-1.44 in	
Deflection due to Haunch and Deck	$\Delta_g =$	-1.95 in	

Deflection due to total self weight	$\Delta_{sw} =$	0.59 in
-------------------------------------	-----------------	---------

Total Deflection at transfer	$\Delta =$	2.48 in	2.48 in
Total Deflection at erection	$\Delta =$	4.49 in	4.49 in

Live load deflection limit = span/800	$=$	1.80 in
Deflection due to live load and impact	$\Delta_L =$	-0.84 in

OK

Deflection due to fire truck	$\Delta_L =$	-0.7571 in
Total Deflection after fire with fire truck	$\Delta =$	3.7982 in

OK

**Location: Fire at Critical Negative Moment Sections**  
**Beam Design: 1/2" Strand**  
**Fire Exposure Status: 1 Hour**

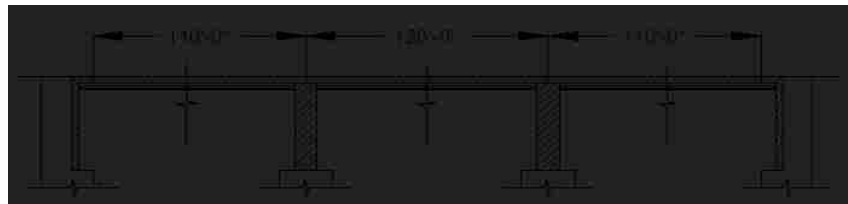
(PCI Bridge Design Manual Section 9.6)



**Material Properties**

CAST-IN-PLACE SLAB		
Actual Thickness	$t_{as} =$	8.0 in
Wearing Surface	$=$	0.5 in
Structural thickness = Actual - Wearing Surface	$t_s =$	7.5 in
Compressive Strength	$f'_c =$	3.57 ksi
Unit Weight	$w_c =$	150.0 pcf
Stress factor of compression block	$\beta_1 =$	0.85

BEAMS: AASHTO-PCI, BT-72 BULB-TEE		
Strength at release	$f'_{ci} =$	5.5 ksi
Strength at 28 days	$f'_c =$	7 ksi
Unit Weight	$w_c =$	150.0 pcf
Overall Beam Length:		
@ end spans	$L =$	110 ft
@ center span	$L =$	119 ft
Design Spans:		
Non-composite beam @ end spans	$L =$	109 ft
Non-composite beam @ center span	$L =$	118 ft
Composite beam @ end spans	$L =$	110 ft
Composite beam @ center span	$L =$	120 ft
Beam Spacing	$S =$	12 ft



**PRESTRESSING STRANDS**

Diameter of single strand	d =	0.5 in
Area of single strand	A =	0.153 in <sup>2</sup>

Temperature of Layer

layer 1 (bottom)	T =	68.00 °F
layer 2	T =	68.00 °F
layer 3	T =	68.00 °F
layer 4	T =	68.00 °F
layer 5	T =	68.00 °F
layer 6	T =	68.00 °F
layer 7	T =	68.00 °F
layer 8	T =	68.00 °F
layer 9	T =	68.00 °F
layer 10	T =	68.00 °F
layer 11	T =	68.00 °F
layer 12	T =	68.00 °F
layer 13	T =	68.00 °F
layer 14	T =	68.00 °F

Ultimate Strength

initial = 277 ksi

layer 1 (bottom)	$f_{pu}$ =	277 ksi
layer 2	$f_{pu}$ =	277 ksi
layer 3	$f_{pu}$ =	277 ksi
layer 4	$f_{pu}$ =	277 ksi
layer 5	$f_{pu}$ =	277 ksi
layer 6	$f_{pu}$ =	277 ksi
layer 7	$f_{pu}$ =	277 ksi
layer 8	$f_{pu}$ =	277 ksi
layer 9	$f_{pu}$ =	277 ksi
layer 10	$f_{pu}$ =	277 ksi
layer 11	$f_{pu}$ =	277 ksi
layer 12	$f_{pu}$ =	277 ksi
layer 13	$f_{pu}$ =	277 ksi
layer 14	$f_{pu}$ =	277 ksi

Yield Strength

initial = 250 ksi

layer 1 (bottom)	$f_{py}$ =	250 ksi
layer 2	$f_{py}$ =	250 ksi
layer 3	$f_{py}$ =	250 ksi
layer 4	$f_{py}$ =	250 ksi
layer 5	$f_{py}$ =	250 ksi
layer 6	$f_{py}$ =	250 ksi
layer 7	$f_{py}$ =	250 ksi
layer 8	$f_{py}$ =	250 ksi
layer 9	$f_{py}$ =	250 ksi
layer 10	$f_{py}$ =	250 ksi
layer 11	$f_{py}$ =	250 ksi
layer 12	$f_{py}$ =	250 ksi
layer 13	$f_{py}$ =	250 ksi
layer 14	$f_{py}$ =	250 ksi

Stress Limits:

before transfer  $\leq 0.75f_{pu}$  (initial = 207.6)

layer 1 (bottom)	$f_{pi}$ =	207.6 ksi
layer 2	$f_{pi}$ =	207.6 ksi
layer 3	$f_{pi}$ =	207.6 ksi
layer 4	$f_{pi}$ =	207.6 ksi
layer 5	$f_{pi}$ =	207.6 ksi
layer 6	$f_{pi}$ =	207.6 ksi
layer 7	$f_{pi}$ =	207.6 ksi
layer 8	$f_{pi}$ =	207.6 ksi
layer 9	$f_{pi}$ =	207.6 ksi
layer 10	$f_{pi}$ =	207.6 ksi
layer 11	$f_{pi}$ =	207.6 ksi
layer 12	$f_{pi}$ =	207.6 ksi
layer 13	$f_{pi}$ =	207.6 ksi
layer 14	$f_{pi}$ =	207.6 ksi

at service limit state (after all losses)  $\leq 0.80f_{py}$  (initial = 199.7)

layer 1 (bottom)	$f_{ps} =$	199.7 ksi
layer 2	$f_{ps} =$	199.7 ksi
layer 3	$f_{ps} =$	199.7 ksi
layer 4	$f_{ps} =$	199.7 ksi
layer 5	$f_{ps} =$	199.7 ksi
layer 6	$f_{ps} =$	199.7 ksi
layer 7	$f_{ps} =$	199.7 ksi
layer 8	$f_{ps} =$	199.7 ksi
layer 9	$f_{ps} =$	199.7 ksi
layer 10	$f_{ps} =$	199.7 ksi
layer 11	$f_{ps} =$	199.7 ksi
layer 12	$f_{ps} =$	199.7 ksi
layer 13	$f_{ps} =$	199.7 ksi
layer 14	$f_{ps} =$	199.7 ksi

Modulus of Elasticity

initial = 25982 ksi

layer 1 (bottom)	E =	25982.0 ksi
layer 2	E =	25982.0 ksi
layer 3	E =	25982.0 ksi
layer 4	E =	25982.0 ksi
layer 5	E =	25982.0 ksi
layer 6	E =	25982.0 ksi
layer 7	E =	25982.0 ksi
layer 8	E =	25982.0 ksi
layer 9	E =	25982.0 ksi
layer 10	E =	25982.0 ksi
layer 11	E =	25982.0 ksi
layer 12	E =	25982.0 ksi
layer 13	E =	25982.0 ksi
layer 14	E =	25982.0 ksi

### MILD STEEL REINFORCING BARS

Yield Strength

Layer 1 (Bottom)	$f_y =$	60.0 ksi	68.00 °F
Layer 2 (Top)	$f_y =$	57.6 ksi	820.00 °F

Modulus of Elasticity

E =	29000.0 ksi
-----	-------------

Layer 1 (Bottom)

Area of steel at midspan (effective flange)	$A_{sm} =$	2.79 in <sup>2</sup>
Area of steel at endspan (effective flange)	$A_{se} =$	2.48 in <sup>2</sup>
Area of temperature and shrinkage steel (12" width)	$A_s =$	0.31 in <sup>2</sup>

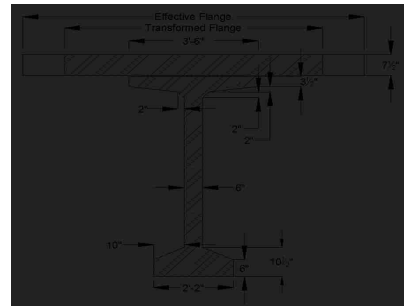
Layer 2 (Top)

Area of steel at midspan (effective flange)	$A_{sm} =$	12.6 in <sup>2</sup>
Area of steel at endspan (effective flange)	$A_{se} =$	12.4 in <sup>2</sup>
Area of temperature and shrinkage steel (12" width)	$A_s =$	0.2 in <sup>2</sup>

### Cross-sectional Properties

#### NON-COMPOSITE BEAM

Area of cross-section of beam	A =	767.0 in <sup>2</sup>
Overall depth of beam	H =	72.0 in
Moment of Inertia	I =	539,947 in <sup>4</sup>
Distance from centroid to extreme bottom fiber	$y_b =$	36.6 in
Distance from centroid to extreme top fiber	$y_t =$	35.4 in
Section modulus for the extreme bottom fiber	$S_b =$	14915.0 in <sup>3</sup>
Section modulus for the extreme top fiber	$S_t =$	15421.0 in <sup>3</sup>
Weight	$W_t =$	799.0 plf
Modulus of Elasticity = $33000 \cdot (W_c^{1.5}) \cdot (\sqrt{f_c})$		
cast-in-place concrete deck	$E_{cs} =$	3622 ksi
precast beam at release	$E_{ci} =$	4496 ksi
precast beam at service loads	$E_c =$	5072 ksi





### COMPOSITE BEAM AT MIDSPAN

Effective Flange Width	$b_f =$	111.0 in	*min of three criteria
Modular Ratio = $E_{cs}/E_c$	$n =$	0.7141	
Transformed flange width	$=$	79.3 in	
Transformed flange area	$=$	594.5 in <sup>2</sup>	
Transformed haunch width	$=$	30.0 in	
Transformed haunch area	$=$	15.0 in <sup>2</sup>	
Deck-distance to top fiber	$y_t =$	4.89 in	

	Transformed Area	$y_b$	$Ay_b$	$A(y_{bc}-y_b)^2$	$I$	$I+A(y_{bc}-y_b)^2$
Beam	767.0 in <sup>2</sup>	36.60 in	28,072.2 in <sup>3</sup>	222,211 in <sup>4</sup>	539,947 in <sup>4</sup>	762,158 in <sup>4</sup>
Haunch	15.0 in <sup>2</sup>	72.25 in	1,083.5 in <sup>3</sup>	5,205 in <sup>4</sup>	0.33 in <sup>4</sup>	5,205 in <sup>4</sup>
Deck	594.5 in <sup>2</sup>	75.11 in	44,654.7 in <sup>3</sup>	274,538 in <sup>4</sup>	1,743 in <sup>4</sup>	276,281 in <sup>4</sup>
Total	1376.5 in <sup>2</sup>		73,810.4 in <sup>3</sup>			1,043,643 in <sup>4</sup>

Total area of Composite Section	$A_c =$	1377 in <sup>2</sup>
Overall Depth of the Composite Section	$h_c =$	80 in
Moment of Inertia	$I_c =$	1,043,643 in <sup>4</sup>
Distance from centroid to extreme <u>bottom</u> fiber of beam	$y_{bc} =$	53.62 in
Distance from centroid to extreme <u>top</u> fiber of beam	$y_{tg} =$	18.38 in
Distance from centroid to extreme <u>top</u> fiber of slab	$y_{tc} =$	26.38 in
Section modulus for the extreme <u>bottom</u> fiber of beam	$S_{bc} =$	19,463.3 in <sup>3</sup>
Section modulus for the extreme <u>top</u> fiber of beam	$S_{tg} =$	56,784.5 in <sup>3</sup>
Section modulus for the extreme <u>top</u> fiber slab	$S_{tc} =$	55,399.9 in <sup>3</sup>

### COMPOSITE BEAM AT ENDSPAN

Effective Flange Width	$b_f =$	106.6 in	*min of three criteria
Modular Ratio = $E_{cs}/E_c$	$n =$	0.7141	
Transformed flange width	$=$	76.1 in	
Transformed flange area	$=$	571.0 in <sup>2</sup>	
Transformed haunch width	$=$	30.0 in	
Transformed haunch area	$=$	15.0 in <sup>2</sup>	
Deck-distance to top fiber	$y_{td} =$	4.89 in	

	Transformed Area	$y_t$	$Ay_t$	$A(y_{tc}-y_t)^2$	$I$	$I+A(y_{tc}-y_t)^2$
Beam	767.0 in <sup>2</sup>	36.60 in	28,072.2 in <sup>3</sup>	271,344 in <sup>4</sup>	539,947 in <sup>4</sup>	811,291 in <sup>4</sup>
Haunch	15.0 in <sup>2</sup>	72.25 in	1,083.5 in <sup>3</sup>	5,306 in <sup>4</sup>	0.31 in <sup>4</sup>	5,306 in <sup>4</sup>
Deck	571.0 in <sup>2</sup>	77.39 in	44,186.4 in <sup>3</sup>	201,989 in <sup>4</sup>	1,677 in <sup>4</sup>	203,666 in <sup>4</sup>
Total	1353.0 in <sup>2</sup>		73,342.1 in <sup>3</sup>			1,020,264 in <sup>4</sup>

Total area of Composite Section	$A_c =$	1353 in <sup>2</sup>
Overall Depth of the Composite Section	$h_c =$	80 in
Moment of Inertia	$I_c =$	1,020,264 in <sup>4</sup>
Distance from centroid to extreme <u>bottom</u> fiber of beam	$y_{bc} =$	54.21 in
Distance from centroid to extreme <u>top</u> fiber of beam	$y_{tg} =$	17.79 in
Distance from centroid to extreme <u>top</u> fiber of slab	$y_{tc} =$	25.79 in
Section modulus for the extreme <u>bottom</u> fiber of beam	$S_{bc} =$	18,821.0 in <sup>3</sup>
Section modulus for the extreme <u>top</u> fiber of beam	$S_{tg} =$	57,346.7 in <sup>3</sup>
Section modulus for the extreme <u>top</u> fiber slab	$S_{tc} =$	39,558.7 in <sup>3</sup>

### Shear Forces and Bending Moments

#### DEAD LOADS

Beam self-weight	$w_{beam} =$	0.799 k/f
8 in. deck weight	$w_{deck} =$	1.200 k/f
1/2 in. haunch weight	$w_{haunch} =$	0.022 k/f

#### LRFD Specifications: Art. 4.6.2.2.1

Width of Deck Constant		OK
Number of beams is not less than four $N_b =$	4	OK
Roadway part of the overhang, $d_o \leq 3.0$ ft, $d_o =$	1.5	OK
Curvature in plans is less than $4^\circ =$	0	OK
Cross-section of the bridge is consistent with one of the cross sections given by LRFD specs		OK

Barrier and wearing surface loads are equally distributed among the 4 beams

Barrier Wt	$W_t =$	0.150 k/f
Dead load of future wearing surface	$DW =$	0.263 k/f

### LIVE LOADS

Fire truck live load front load (Point A)	$P_{live} =$	48.0 kips
Fire truck live load back load (Point B)	$P_{live} =$	22.0 kips
distance between two loads		19.2 ft
distance from nearest edge to point A	$x_a =$	59.0 ft
distance from nearest edge to point B	$x_b =$	39.8 ft
LRFD Specifications: Art. 4.6.2.2.1		
Width of Deck Constant		OK
Number of beams is not less than four $N_b =$	4	OK
Beams are parallel and approximately of the same stiffness		OK
Roadway part of the overhang, $d_o \leq 3.0$ ft, $d_o =$	1.5	OK
Curvature in plans is less than $4^\circ =$	0	OK

Barrier and wearing surface loads are equally distributed among the 4 beams

Bridge Type-- "k" (LRFD Table 4.6.2.1-1)

Number of design lanes = $w/12$	=	3 lanes
---------------------------------	---	---------

### Distribution Factor for Bending Moment:

Beams spacing	$S =$	12.0 ft
Depth of concrete slab	$t_s =$	7.5 in
Beam Span	$L =$	120.0 ft
Number of Beams	$N_b =$	4
Modular ratio between beam & deck materials	$n =$	1.4003
Longitudinal stiffness parameter	$K_g =$	2,444,559.90 in <sup>4</sup>

at center span:

$$DFM = 0.75 + \left(\frac{S}{9.5}\right)^{0.6} * \left(\frac{S}{L}\right)^{0.2} * \left(\frac{K_g}{12 * L * t_s^3}\right)^{0.1}$$

DFM =	0.909 lanes/beam
-------	------------------

0.905 Controls

one design lane loaded:

$$DFM = 0.75 + \left(\frac{S}{14}\right)^{0.4} * \left(\frac{S}{L}\right)^{0.2} * \left(\frac{K_g}{12 * L * t_s^3}\right)^{0.1}$$

DFM =	0.617 lanes/beam
-------	------------------

### Distribution Factor for Shear Force

both end spans and center span:

$$DFV = 0.2 + \left(\frac{S}{12}\right) - \left(\frac{S}{35}\right)^2$$

DFV =	1.082 lanes/beam
-------	------------------

1.082 Controls

one design lane loaded:

$$DFV = 0.36 + \left(\frac{S}{25}\right)$$

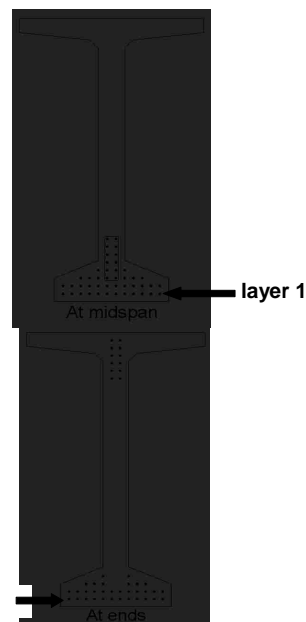
DFV =	0.840 lanes/beam
-------	------------------

	At Midspan		At Ends	
from bottom	No. of	Distance from Bottom	No. of	Distance from Bottom
layer 1	12	2	12	2
layer 2	12	4	12	4
layer 3	8	6	6	6
layer 4	4	8	2	8
layer 5	2	10	-	-
layer 6	2	12	-	-
layer 7	2	14	-	-
layer 8	2	16	-	-
layer 9	-	-	2	60
layer 10	-	-	2	62
layer 11	-	-	2	64
layer 12	-	-	2	66
layer 13	-	-	2	68
layer 14	-	-	2	70
<b>Harped Strand Group (included in above totals)</b>				
layer 3	2	6		
layer 4	2	8		
layer 5	2	10		
layer 6	2	12		
layer 7	2	14		
layer 8	2	16		

distance from the center of gravity of strands to the bottom fiber of the beam = 7% of the beam depth  
strand eccentricity at midspan =  $(y_b - y_{bs})$

$y_{bs} =$	5.82 in
$e_c =$	30.78 in

layer 1



**Prestress Losses**

**ELASTIC SHORTENING**

assumed loss	=	9.00%
Force per strand at transfer		
layer 1	=	28.9 kips
layer 2	=	28.9 kips
layer 3	=	28.9 kips
layer 4	=	28.9 kips
layer 5	=	28.9 kips
layer 6	=	28.9 kips
layer 7	=	28.9 kips
layer 8	=	28.9 kips
layer 9	=	28.9 kips
layer 10	=	28.9 kips
layer 11	=	28.9 kips
layer 12	=	28.9 kips
layer 13	=	28.9 kips
layer 14	=	28.9 kips

		<b>at midspan</b>	<b>at endspan</b>
Total prestressing force at release	$P_i =$	1271.6 kips	1271.6 kips
Sum of concrete stresses at the center of gravity of prestressing tendons due to prestressing force at transfer and the self-weight of the member at sections of maximum moment	$f_{cgp} =$	2.938 ksi	2.938 ksi
Loss due to shortening		<b>at midspan</b>	<b>at endspan</b>
layer 1	$\Delta f_{PES} =$	17.0 ksi	17.0 ksi
layer 2	$\Delta f_{PES} =$	17.0 ksi	17.0 ksi
layer 3	$\Delta f_{PES} =$	17.0 ksi	17.0 ksi
layer 4	$\Delta f_{PES} =$	17.0 ksi	17.0 ksi
layer 5	$\Delta f_{PES} =$	17.0 ksi	
layer 6	$\Delta f_{PES} =$	17.0 ksi	
layer 7	$\Delta f_{PES} =$	17.0 ksi	
layer 8	$\Delta f_{PES} =$	17.0 ksi	
layer 9	$\Delta f_{PES} =$		17.0 ksi
layer 10	$\Delta f_{PES} =$		17.0 ksi
layer 11	$\Delta f_{PES} =$		17.0 ksi
layer 12	$\Delta f_{PES} =$		17.0 ksi
layer 13	$\Delta f_{PES} =$		17.0 ksi
layer 14	$\Delta f_{PES} =$		17.0 ksi

**SHRINKAGE**

Shrinkage = (17-0.15*Relative Humidity)	$\Delta f_{PSR} =$	6.5 ksi	← assume relative humidity = 70%
---	--------------------	---------	----------------------------------

**CREEP OF CONCRETE**

Change of stresses at center of gravity of prestressing due to permanent loads except the loads acting at time of applying prestressing force, calculated at the same section as $f_{cgp}$	$\Delta f_{cdp} =$	1.566 ksi	
loss due to creep	$\Delta f_{PCR} =$	24.3 ksi	24.3 ksi

**RELAXATION OF PRESTRESSING STRANDS**

loss due to relaxation after transfer		<b>at midspan</b>	<b>at endspan</b>
layer 1	$\Delta f_{PR2} =$	2.1 ksi	2.1 ksi
layer 2	$\Delta f_{PR2} =$	2.1 ksi	2.1 ksi
layer 3	$\Delta f_{PR2} =$	2.1 ksi	2.1 ksi
layer 4	$\Delta f_{PR2} =$	2.1 ksi	2.1 ksi
layer 5	$\Delta f_{PR2} =$	2.1 ksi	
layer 6	$\Delta f_{PR2} =$	2.1 ksi	
layer 7	$\Delta f_{PR2} =$	2.1 ksi	
layer 8	$\Delta f_{PR2} =$	2.1 ksi	
layer 9	$\Delta f_{PR2} =$		2.1 ksi
layer 10	$\Delta f_{PR2} =$		2.1 ksi
layer 11	$\Delta f_{PR2} =$		2.1 ksi
layer 12	$\Delta f_{PR2} =$		2.1 ksi
layer 13	$\Delta f_{PR2} =$		2.1 ksi
layer 14	$\Delta f_{PR2} =$		2.1 ksi

**TOTAL LOSSES AT TRANSFER**

total loss  $\Delta f_{pES} = \Delta f_{pi}$

stress in tendons after transfer  $f_{pi} = f_{pr} - \Delta f_{pi}$

		at midspan	at endspan
layer 1	$f_{pi} =$	190.6 ksi	190.6 ksi
layer 2	$f_{pi} =$	190.6 ksi	190.6 ksi
layer 3	$f_{pi} =$	190.6 ksi	190.6 ksi
layer 4	$f_{pi} =$	190.6 ksi	190.6 ksi
layer 5	$f_{pi} =$	190.6 ksi	
layer 6	$f_{pi} =$	190.6 ksi	
layer 7	$f_{pi} =$	190.6 ksi	
layer 8	$f_{pi} =$	190.6 ksi	
layer 9	$f_{pi} =$		190.6 ksi
layer 10	$f_{pi} =$		190.6 ksi
layer 11	$f_{pi} =$		190.6 ksi
layer 12	$f_{pi} =$		190.6 ksi
layer 13	$f_{pi} =$		190.6 ksi
layer 14	$f_{pi} =$		190.6 ksi

force per strand =  $f_{pi} \times \text{strand area}$

		at midspan	at endspan
layer 1	=	29.2 kips	29.2 kips
layer 2	=	29.2 kips	29.2 kips
layer 3	=	29.2 kips	29.2 kips
layer 4	=	29.2 kips	29.2 kips
layer 5	=	29.2 kips	
layer 6	=	29.2 kips	
layer 7	=	29.2 kips	
layer 8	=	29.2 kips	
layer 9	=		29.2 kips
layer 10	=		29.2 kips
layer 11	=		29.2 kips
layer 12	=		29.2 kips
layer 13	=		29.2 kips
layer 14	=		29.2 kips

Total prestressing force after transfer

Initial loss =  $(\Delta f_{pi}) / (f_{pi})$

		at midspan	at endspan
layer 1	% =	8.2%	8.2%
layer 2	% =	8.2%	8.2%
layer 3	% =	8.2%	8.2%
layer 4	% =	8.2%	8.2%
layer 5	% =	8.2%	
layer 6	% =	8.2%	
layer 7	% =	8.2%	
layer 8	% =	8.2%	
layer 9	% =		8.2%
layer 10	% =		8.2%
layer 11	% =		8.2%
layer 12	% =		8.2%
layer 13	% =		8.2%
layer 14	% =		8.2%

OK  
OK  
OK  
OK  
OK  
OK  
OK  
OK  
OK  
OK  
OK  
OK  
OK  
OK

**TOTAL LOSSES AT SERVICE LOADS**

Total Losses

		at midspan	at endspan
layer 1	$\Delta f_{pT} =$	49.9 ksi	49.9 ksi
layer 2	$\Delta f_{pT} =$	49.9 ksi	49.9 ksi
layer 3	$\Delta f_{pT} =$	49.9 ksi	49.9 ksi
layer 4	$\Delta f_{pT} =$	49.9 ksi	49.9 ksi
layer 5	$\Delta f_{pT} =$	49.9 ksi	
layer 6	$\Delta f_{pT} =$	49.9 ksi	
layer 7	$\Delta f_{pT} =$	49.9 ksi	
layer 8	$\Delta f_{pT} =$	49.9 ksi	
layer 9	$\Delta f_{pT} =$		49.9 ksi
layer 10	$\Delta f_{pT} =$		49.9 ksi
layer 11	$\Delta f_{pT} =$		49.9 ksi
layer 12	$\Delta f_{pT} =$		49.9 ksi
layer 13	$\Delta f_{pT} =$		49.9 ksi
layer 14	$\Delta f_{pT} =$		49.9 ksi

Stress in tendon after all losses =  $f_{pe} - \Delta f_{pt}$

		at midspan	at endspan
layer 1	$f_{pe} =$	157.7 ksi	157.7 ksi
layer 2	$f_{pe} =$	157.7 ksi	157.7 ksi
layer 3	$f_{pe} =$	157.7 ksi	157.7 ksi
layer 4	$f_{pe} =$	157.7 ksi	157.7 ksi
layer 5	$f_{pe} =$	157.7 ksi	
layer 6	$f_{pe} =$	157.7 ksi	
layer 7	$f_{pe} =$	157.7 ksi	
layer 8	$f_{pe} =$	157.7 ksi	
layer 9	$f_{pe} =$		157.7 ksi
layer 10	$f_{pe} =$		157.7 ksi
layer 11	$f_{pe} =$		157.7 ksi
layer 12	$f_{pe} =$		157.7 ksi
layer 13	$f_{pe} =$		157.7 ksi
layer 14	$f_{pe} =$		157.7 ksi

check prestressing stress limit at service limit state:  $f_{pe} \leq 0.8 \cdot f_{py}$

layer 1	=	199.7 ksi
layer 2	=	199.7 ksi
layer 3	=	199.7 ksi
layer 4	=	199.7 ksi
layer 5	=	199.7 ksi
layer 6	=	199.7 ksi
layer 7	=	199.7 ksi
layer 8	=	199.7 ksi
layer 9	=	199.7 ksi
layer 10	=	199.7 ksi
layer 11	=	199.7 ksi
layer 12	=	199.7 ksi
layer 13	=	199.7 ksi
layer 14	=	199.7 ksi

OK  
OK  
OK  
OK  
OK  
OK  
OK  
OK  
OK  
OK  
OK  
OK  
OK  
OK

force per strand =  $f_{pe} \cdot \text{strand area}$

		at midspan	at endspan
layer 1	=	24.1 kips	24.1 kips
layer 2	=	24.1 kips	24.1 kips
layer 3	=	24.1 kips	24.1 kips
layer 4	=	24.1 kips	24.1 kips
layer 5	=	24.1 kips	
layer 6	=	24.1 kips	
layer 7	=	24.1 kips	
layer 8	=	24.1 kips	
layer 9	=		24.1 kips
layer 10	=		24.1 kips
layer 11	=		24.1 kips
layer 12	=		24.1 kips
layer 13	=		24.1 kips
layer 14	=		24.1 kips

Total prestressing force after all losses

		at midspan	at endspan
$P_{pe} =$		1061.7 kips	1061.7 kips

Final losses, % =  $(\Delta f_{pt}) / (f_{pi})$

layer 1	% =	24.0%	24.0%
layer 2	% =	24.0%	24.0%
layer 3	% =	24.0%	24.0%
layer 4	% =	24.0%	24.0%
layer 5	% =	24.0%	
layer 6	% =	24.0%	
layer 7	% =	24.0%	
layer 8	% =	24.0%	
layer 9	% =		24.0%
layer 10	% =		24.0%
layer 11	% =		24.0%
layer 12	% =		24.0%
layer 13	% =		24.0%
layer 14	% =		24.0%
Average final losses, %	% =	24.0%	24.0%

## Stresses at Transfer

### STRESS LIMITS FOR CONCRETE

Compression = $0.6f_{ci}$	$f_{ci} =$	3.300 ksi
Tension		
without bonded reinforcement = $-0.0948\sqrt{f_{ci}} \leq -0.2$	=	-0.200 ksi
with bonded auxiliary reinforcement = $-0.22\sqrt{f_{ci}}$	=	-0.016 ksi

### STRESSES AT TRANSFER LENGTH SECTION

Transfer Length = $60 \times (\text{strand diameter})$	=	2.5 ft	} Calcs for eccentricity (see 9.6.7.2)
Bending moment at transfer length	$M_0 =$	116.4 ft-kips	
center of 12 strands to top fiber of beam at the end	=	7.00 in	
center of 12 strands to bottom fiber of beam at the harp point	=	11.00 in	
center of 12 strands and top fiber of beam at transfer length	=	10.78 in	
center of gravity of 32 strands and bottom fiber of beam	=	3.88 in	
center of gravity of all strands and the bottom fiber of beam at transfer length	=	19.51 in	
center of gravity of all strands and the bottom fiber of beam at the end	=	20.55 in	
Eccentricity of the strand group at transfer length:	$e_n =$	17.09 in	
Eccentricity at end of beam:	$e =$	16.05 in	

$$f_t = \frac{P_i}{A} - \frac{P_i e}{S_t} + \frac{M_f}{S_t} \qquad f_b = \frac{P_i}{A} + \frac{P_i e}{S_b} - \frac{M_f}{S_b}$$

		at midspan	at endspan	
Top stress at top fiber of beam	$f_t =$	0.342 ksi	0.342 ksi	OK
Bottom stress at bottom fiber of the beam	$f_b =$	3.021 ksi	3.021 ksi	OK

### STRESSES AT HARP POINT

Bending moment due to beam weight at 0.3L	$M_0 =$	1188.0 ft-kips		
Top stress at top fiber of beam	$f_t =$	0.035 ksi	0.035 ksi	OK
Bottom stress at bottom fiber of the beam	$f_b =$	3.300 ksi	3.300 ksi	OK

### STRESSES AT MIDSPAN

Bending moment due to beam weight at 0.5L	$M_0 =$	1414.3 ft-kips		
Top stress at top fiber of beam	$f_t =$	0.220 ksi	0.211 ksi	OK
Bottom stress at bottom fiber of the beam	$f_b =$	3.144 ksi	3.189 ksi	OK

### HOLD-DOWN FORCES

assume stress in strand before losses =  $0.8f_u$

layer 1	=	221.4 ksi
layer 2	=	221.4 ksi
layer 3	=	221.4 ksi
layer 4	=	221.4 ksi
layer 5	=	221.4 ksi
layer 6	=	221.4 ksi
layer 7	=	221.4 ksi
layer 8	=	221.4 ksi
layer 9	=	221.4 ksi
layer 10	=	221.4 ksi
layer 11	=	221.4 ksi
layer 12	=	221.4 ksi
layer 13	=	221.4 ksi
layer 14	=	221.4 ksi

prestress force per strand before any losses:

layer 1	=	33.9 kips
layer 2	=	33.9 kips
layer 3	=	33.9 kips
layer 4	=	33.9 kips
layer 5	=	33.9 kips
layer 6	=	33.9 kips
layer 7	=	33.9 kips
layer 8	=	33.9 kips
layer 9	=	33.9 kips
layer 10	=	33.9 kips
layer 11	=	33.9 kips
layer 12	=	33.9 kips
layer 13	=	33.9 kips
layer 14	=	33.9 kips
Harp Angle	$\psi =$	7.2 °

Hold-down force/strand

layer 1	=	4.4 kips/strand
layer 2	=	4.4 kips/strand
layer 3	=	4.4 kips/strand
layer 4	=	4.4 kips/strand
layer 5	=	4.4 kips/strand
layer 6	=	4.4 kips/strand
layer 7	=	4.4 kips/strand
layer 8	=	4.4 kips/strand
layer 9	=	4.4 kips/strand
layer 10	=	4.4 kips/strand
layer 11	=	4.4 kips/strand
layer 12	=	4.4 kips/strand
layer 13	=	4.4 kips/strand
layer 14	=	4.4 kips/strand
Total hold-down force	=	53.39 kips

**Stresses at Service Loads**

**STRESS LIMITS FOR CONCRETE**

**Compression:**

Due to permanent loads for load combination Service I

for the precast beam	=	3.150 ksi
for deck	=	1.607 ksi

Due to permanent and transient loads for load combination Service I

for the precast beam	=	4.200 ksi
for deck	=	2.142 ksi

**Tension:**

Load Combination Service III

for the precast beam	=	-0.016 ksi
----------------------	---	------------

**STRESSES AT MIDSPAN**

Compression stresses at top fiber of beam	at midspan	at endspan		
$f_t = \frac{P_{ps}}{A} - \frac{P_{ps}e}{S_t} + \frac{(M_D + M_L)}{S_t} + \frac{(M_{ws} + M_B)}{S_{tr}}$				
Due to permanent loads	$f_{t0} =$	2.045 ksi	2.045 ksi	OK
$f_{tr} = \frac{P_{ps}}{A} - \frac{P_{ps}e}{S_t} + \frac{(M_D + M_L)}{S_t} + \frac{(M_{ws} + M_B)}{S_{tr}} + \frac{(M_{LL+1})}{S_{tr}}$				
Due to permanent loads and transient loads	$f_{t0} =$	2.492 ksi	2.492 ksi	OK
Compression stresses at top fiber of deck	at midspan	at endspan		
$f_{tc} = \frac{(M_{ws} + M_B)}{S_{tr}}$				
Due to permanent loads	$f_{tc} =$	0.044 ksi	0.044 ksi	OK
$f_{tr} = \frac{(M_{ws} + M_B + M_{LL+1})}{S_{tr}}$				
Due to permanent loads and transient loads	$f_{tc} =$	0.502 ksi	0.502 ksi	OK
Tension stresses at top fiber of deck	at midspan	at endspan		
$f_{tr} = \frac{P_{ps}}{A} + \frac{P_{ps}e}{S_t} - \frac{(M_D + M_L)}{S_t} - \frac{(M_{ws} + M_B + 0.8 * M_{LL+1})}{S_{tr}}$				
Load Combination Service III	$f_b =$	-0.422 ksi	-0.422 ksi	OK

**Strength Limit State**

POSITIVE MOMENT SECTION		
$M_u = 1.25DC+1.5DW+1.75(LL+IM)$	$M_u =$	8381.5 ft-kips

effective length factor for compression members

layer 1	k =	0.28
layer 2	k =	0.28
layer 3	k =	0.28
layer 4	k =	0.28
layer 5	k =	0.28
layer 6	k =	0.28
layer 7	k =	0.28
layer 8	k =	0.28
layer 9	k =	0.28
layer 10	k =	0.28
layer 11	k =	0.28
layer 12	k =	0.28
layer 13	k =	0.28
layer 14	k =	0.28
	c =	6.4 ft-kips

average stress in prestressing steel

layer 1	$f_{ps} =$	270.2 ksi
layer 2	$f_{ps} =$	270.2 ksi
layer 3	$f_{ps} =$	270.2 ksi
layer 4	$f_{ps} =$	270.2 ksi
layer 5	$f_{ps} =$	270.2 ksi
layer 6	$f_{ps} =$	270.2 ksi
layer 7	$f_{ps} =$	270.2 ksi
layer 8	$f_{ps} =$	270.2 ksi
layer 9	$f_{ps} =$	270.2 ksi
layer 10	$f_{ps} =$	270.2 ksi
layer 11	$f_{ps} =$	270.2 ksi
layer 12	$f_{ps} =$	270.2 ksi
layer 13	$f_{ps} =$	270.2 ksi
layer 14	$f_{ps} =$	270.2 ksi

nominal flexure resistance

	a =	5.42 in
$M_r = \Phi M_n, \Phi = 1.00$	$\Phi M_n =$	10835.1 ft-kips
M=DC+W+LL+IM	M =	5833.6 ft-kips

OK

OK

NEGATIVE MOMENT SECTION		
$M_u = 1.25DC+1.5DW+1.75(LL+IM)$	$M_u =$	-4837.2 ft-kips

	a =	5.77 in
	$\Phi M_n =$	4748.7 ft-kips
M=DC+W+LL+IM	M =	-2869.7 ft-kips

NOT OK

OK



## Shear Design

CRITICAL SECTION AT 0.59			
$V_u = 1.25DC + 1.5DW + 1.75(LL + IM)$	$V_u =$	405.0 kips	
$M_u = 1.25DC + 1.5DW + 1.75(LL + IM)$	$M_u =$	-2684.4 ft-kips	
or			
$V_u = 1.25DC + 1.5DW + 1.75(LL + IM)$	$V_u =$	364.8 kips	
$M_u = 1.25DC + 1.5DW + 1.75(LL + IM)$	$M_u =$	-2877.0 ft-kips	
max shear	$V_u =$	405.0 kips	
max moment	$M_u =$	2877.0 ft-kips	
Shear depth	$d_v =$	73.19 in	
Applied factored normal force at the section	$N_u =$	0	
Angle of diagonal compressive stresses	$\theta =$	36.00 °	

### STRAIN IN FLEXURAL TENSION REINFORCEMENT

$$\epsilon_x = \frac{\frac{I}{d_v} + 0.5N_u + 0.5V_u \cot \theta - A_{ps} f_{ps}}{E_s A_s + E_p A_p} \leq 0.002$$

	at midspan	at endspan	
resultant compressive stress at centroid	$f_{pc} =$	1.016 ksi	1.016 ksi

effective stress in prestressing strand after all losses

	at midspan	at endspan
layer 1	$f_{po} =$	162.9 ksi
layer 2	$f_{po} =$	162.9 ksi
layer 3	$f_{po} =$	162.9 ksi
layer 4	$f_{po} =$	162.9 ksi
layer 5	$f_{po} =$	
layer 6	$f_{po} =$	
layer 7	$f_{po} =$	
layer 8	$f_{po} =$	
layer 9	$f_{po} =$	162.9 ksi
layer 10	$f_{po} =$	162.9 ksi
layer 11	$f_{po} =$	162.9 ksi
layer 12	$f_{po} =$	162.9 ksi
layer 13	$f_{po} =$	162.9 ksi
layer 14	$f_{po} =$	162.9 ksi

strain in flexural tension

	at midspan	at endspan
layer 1	$\epsilon_x =$	0.002000
layer 2	$\epsilon_x =$	0.002000
layer 3	$\epsilon_x =$	0.002000
layer 4	$\epsilon_x =$	0.002000
layer 5	$\epsilon_x =$	
layer 6	$\epsilon_x =$	
layer 7	$\epsilon_x =$	
layer 8	$\epsilon_x =$	
layer 9	$\epsilon_x =$	0.002000
layer 10	$\epsilon_x =$	0.002000
layer 11	$\epsilon_x =$	0.002000
layer 12	$\epsilon_x =$	0.002000
layer 13	$\epsilon_x =$	0.002000
layer 14	$\epsilon_x =$	0.002000

## Deflection and Camber

	at midspan	at endspan
Deflection due to Prestressing Force at Transfer	$\Delta_p =$	3.97 in
Deflection due to Beam Self-Weight at Transfer	$\Delta_g =$	-1.49 in
Deflection due to Beam Self-Weight at Erection	$\Delta_g =$	-1.44 in
Deflection due to Haunch and Deck	$\Delta_g =$	-1.95 in

Deflection due to total self weight

$\Delta_{sw} =$	0.59 in
-----------------	---------

Total Deflection at transfer

$\Delta =$	2.48 in	2.48 in
------------	---------	---------

Total Deflection at erection

$\Delta =$	4.49 in	4.49 in
------------	---------	---------

Live load deflection limit = span/800

$=$	1.80 in
-----	---------

Deflection due to live load and impact

$\Delta_L =$	-0.85 in
--------------	----------

OK

Deflection due to fire truck

$\Delta_L =$	-0.7646 in
--------------	------------

OK

Total Deflection after fire with fire truck

$\Delta =$	3.7907 in
------------	-----------

**Location: Fire at Critical Negative Moment Sections**  
**Beam Design: 1/2" Strand**  
**Fire Exposure Status: 1-1/2 Hour**

(PCI Bridge Design Manual Section 9.6)



**Material Properties**

CAST-IN-PLACE SLAB		
Actual Thickness	$t_{as} =$	8.0 in
Wearing Surface	$=$	0.5 in
Structural thickness = Actual - Wearing Surface	$t_s =$	7.5 in
Compressive Strength	$f_c =$	3.39 ksi
Unit Weight	$w_c =$	150.0 pcf
Stress factor of compression block	$\beta_1 =$	0.85

BEAMS: AASHTO-PCI, BT-72 BULB-TEE		
Strength at release	$f'_{ci} =$	5.5 ksi
Strength at 28 days	$f'_c =$	7 ksi
Unit Weight	$w_c =$	150.0 pcf
Overall Beam Length:		
@ end spans	$L =$	110 ft
@ center span	$L =$	119 ft
Design Spans:		
Non-composite beam @ end spans	$L =$	109 ft
Non-composite beam @ center span	$L =$	118 ft
Composite beam @ end spans	$L =$	110 ft
Composite beam @ center span	$L =$	120 ft
Beam Spacing	$S =$	12 ft



**PRESTRESSING STRANDS**

Diameter of single strand	d =	0.5 in
Area of single strand	A =	0.153 in <sup>2</sup>

Temperature of Layer	layer 1 (bottom)	T =	68.00 °F
	layer 2	T =	68.00 °F
	layer 3	T =	68.00 °F
	layer 4	T =	68.00 °F
	layer 5	T =	68.00 °F
	layer 6	T =	68.00 °F
	layer 7	T =	68.00 °F
	layer 8	T =	68.00 °F
	layer 9	T =	68.00 °F
	layer 10	T =	68.00 °F
	layer 11	T =	68.00 °F
	layer 12	T =	68.00 °F
	layer 13	T =	68.00 °F
	layer 14	T =	68.00 °F

Ultimate Strength initial = 277 ksi	layer 1 (bottom)	$f_{pu}$ =	277 ksi
	layer 2	$f_{pu}$ =	277 ksi
	layer 3	$f_{pu}$ =	277 ksi
	layer 4	$f_{pu}$ =	277 ksi
	layer 5	$f_{pu}$ =	277 ksi
	layer 6	$f_{pu}$ =	277 ksi
	layer 7	$f_{pu}$ =	277 ksi
	layer 8	$f_{pu}$ =	277 ksi
	layer 9	$f_{pu}$ =	277 ksi
	layer 10	$f_{pu}$ =	277 ksi
	layer 11	$f_{pu}$ =	277 ksi
	layer 12	$f_{pu}$ =	277 ksi
	layer 13	$f_{pu}$ =	277 ksi
	layer 14	$f_{pu}$ =	277 ksi

Yield Strength initial = 250 ksi	layer 1 (bottom)	$f_{py}$ =	250 ksi
	layer 2	$f_{py}$ =	250 ksi
	layer 3	$f_{py}$ =	250 ksi
	layer 4	$f_{py}$ =	250 ksi
	layer 5	$f_{py}$ =	250 ksi
	layer 6	$f_{py}$ =	250 ksi
	layer 7	$f_{py}$ =	250 ksi
	layer 8	$f_{py}$ =	250 ksi
	layer 9	$f_{py}$ =	250 ksi
	layer 10	$f_{py}$ =	250 ksi
	layer 11	$f_{py}$ =	250 ksi
	layer 12	$f_{py}$ =	250 ksi
	layer 13	$f_{py}$ =	250 ksi
	layer 14	$f_{py}$ =	250 ksi

<b>Stress Limits:</b> before transfer $\leq 0.75f_{pu}$ (initial = 207.6)	layer 1 (bottom)	$f_{pi}$ =	207.6 ksi
	layer 2	$f_{pi}$ =	207.6 ksi
	layer 3	$f_{pi}$ =	207.6 ksi
	layer 4	$f_{pi}$ =	207.6 ksi
	layer 5	$f_{pi}$ =	207.6 ksi
	layer 6	$f_{pi}$ =	207.6 ksi
	layer 7	$f_{pi}$ =	207.6 ksi
	layer 8	$f_{pi}$ =	207.6 ksi
	layer 9	$f_{pi}$ =	207.6 ksi
	layer 10	$f_{pi}$ =	207.6 ksi
	layer 11	$f_{pi}$ =	207.6 ksi
	layer 12	$f_{pi}$ =	207.6 ksi
	layer 13	$f_{pi}$ =	207.6 ksi
	layer 14	$f_{pi}$ =	207.6 ksi

at service limit state (after all losses)  $\leq 0.80f_{py}$  (initial = 199.7)

layer 1 (bottom)	$f_{pe} =$	199.7 ksi
layer 2	$f_{pe} =$	199.7 ksi
layer 3	$f_{pe} =$	199.7 ksi
layer 4	$f_{pe} =$	199.7 ksi
layer 5	$f_{pe} =$	199.7 ksi
layer 6	$f_{pe} =$	199.7 ksi
layer 7	$f_{pe} =$	199.7 ksi
layer 8	$f_{pe} =$	199.7 ksi
layer 9	$f_{pe} =$	199.7 ksi
layer 10	$f_{pe} =$	199.7 ksi
layer 11	$f_{pe} =$	199.7 ksi
layer 12	$f_{pe} =$	199.7 ksi
layer 13	$f_{pe} =$	199.7 ksi
layer 14	$f_{pe} =$	199.7 ksi

Modulus of Elasticity

initial = 25982 ksi

layer 1 (bottom)	E =	25982.0 ksi
layer 2	E =	25982.0 ksi
layer 3	E =	25982.0 ksi
layer 4	E =	25982.0 ksi
layer 5	E =	25982.0 ksi
layer 6	E =	25982.0 ksi
layer 7	E =	25982.0 ksi
layer 8	E =	25982.0 ksi
layer 9	E =	25982.0 ksi
layer 10	E =	25982.0 ksi
layer 11	E =	25982.0 ksi
layer 12	E =	25982.0 ksi
layer 13	E =	25982.0 ksi
layer 14	E =	25982.0 ksi

### MILD STEEL REINFORCING BARS

Yield Strength

Layer 1 (Bottom)	$f_y =$	60.0 ksi	68.00 °F
Layer 2 (Top)	$f_y =$	55.4 ksi	1010.00 °F

Modulus of Elasticity

E =	29000.0 ksi
-----	-------------

Layer 1 (Bottom)

Area of steel at midspan (effective flange)	$A_{sm} =$	2.79 in <sup>2</sup>
Area of steel at endspan (effective flange)	$A_{se} =$	2.48 in <sup>2</sup>
Area of temperature and shrinkage steel (12" width)	$A_s =$	0.31 in <sup>2</sup>

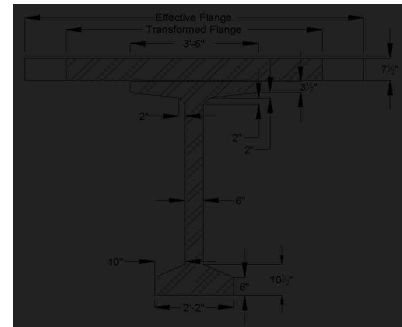
Layer 2 (Top)

Area of steel at midspan (effective flange)	$A_{sm} =$	12.6 in <sup>2</sup>
Area of steel at endspan (effective flange)	$A_{se} =$	12.4 in <sup>2</sup>
Area of temperature and shrinkage steel (12" width)	$A_s =$	0.2 in <sup>2</sup>

### Cross-sectional Properties

#### NON-COMPOSITE BEAM

Area of cross-section of beam	A =	767.0 in <sup>2</sup>
Overall depth of beam	H =	72.0 in
Moment of Inertia	I =	539,947 in <sup>4</sup>
Distance from centroid to extreme bottom fiber	$y_b =$	36.6 in
Distance from centroid to extreme top fiber	$y_t =$	35.4 in
Section modulus for the extreme bottom fiber	$S_b =$	14915.0 in <sup>3</sup>
Section modulus for the extreme top fiber	$S_t =$	15421.0 in <sup>3</sup>
Weight	$W_1 =$	799.0 plf
Modulus of Elasticity = $33000 \cdot (W_c^{1.5}) \cdot (\sqrt{f_c})$		
cast-in-place concrete deck	$E_{cp} =$	3530 ksi
precast beam at release	$E_{ci} =$	4496 ksi
precast beam at service loads	$E_c =$	5072 ksi



### COMPOSITE BEAM AT MIDSPAN

Effective Flange Width	$b_f =$	111.0 in	*min of three criteria
Modular Ratio = $E_{cf}/E_c$	$n =$	0.6959	
Transformed flange width	$=$	77.2 in	
Transformed flange area	$=$	579.3 in <sup>2</sup>	
Transformed haunch width	$=$	29.2 in	
Transformed haunch area	$=$	14.6 in <sup>2</sup>	
Deck-distance to top fiber	$y_t =$	5.14 in	

	Transformed Area	$y_b$	$Ay_b$	$A(y_{bc}-y_b)^2$	I	$I + A(y_{bc}-y_b)^2$
Beam	767.0 in <sup>2</sup>	36.60 in	28,072.2 in <sup>3</sup>	213,131 in <sup>4</sup>	539,947 in <sup>4</sup>	753,078 in <sup>4</sup>
Haunch	14.6 in <sup>2</sup>	72.25 in	1,055.9 in <sup>3</sup>	5,265 in <sup>4</sup>	0.30 in <sup>4</sup>	5,265 in <sup>4</sup>
Deck	579.3 in <sup>2</sup>	74.86 in	43,369.5 in <sup>3</sup>	270,057 in <sup>4</sup>	1,399 in <sup>4</sup>	271,456 in <sup>4</sup>
Total	1361.0 in <sup>2</sup>		72,497.6 in <sup>3</sup>			1,029,799 in <sup>4</sup>

Total area of Composite Section	$A_c =$	1361 in <sup>2</sup>
Overall Depth of the Composite Section	$h_c =$	80 in
Moment of Inertia	$I_c =$	1,029,799 in <sup>4</sup>
Distance from centroid to extreme <u>bottom</u> fiber of beam	$y_{bc} =$	53.27 in
Distance from centroid to extreme <u>top</u> fiber of beam	$y_{tc} =$	18.73 in
Distance from centroid to extreme <u>top</u> fiber of slab	$y_{ts} =$	26.73 in
Section modulus for the extreme <u>bottom</u> fiber of beam	$S_{bc} =$	19,331.8 in <sup>3</sup>
Section modulus for the extreme <u>top</u> fiber of beam	$S_{tc} =$	54,980.1 in <sup>3</sup>
Section modulus for the extreme <u>top</u> fiber slab	$S_{ts} =$	55,360.1 in <sup>3</sup>

### COMPOSITE BEAM AT ENDSpan

Effective Flange Width	$b_f =$	106.6 in	*min of three criteria
Modular Ratio = $E_{cf}/E_c$	$n =$	0.6959	
Transformed flange width	$=$	74.2 in	
Transformed flange area	$=$	556.4 in <sup>2</sup>	
Transformed haunch width	$=$	29.2 in	
Transformed haunch area	$=$	14.6 in <sup>2</sup>	
Deck-distance to top fiber	$y_{td} =$	5.14 in	

	Transformed Area	$y_t$	$Ay_t$	$A(y_{tc}-y_t)^2$	I	$I + A(y_{tc}-y_t)^2$
Beam	767.0 in <sup>2</sup>	36.60 in	28,072.2 in <sup>3</sup>	266,924 in <sup>4</sup>	539,947 in <sup>4</sup>	806,871 in <sup>4</sup>
Haunch	14.6 in <sup>2</sup>	72.25 in	1,055.9 in <sup>3</sup>	5,086 in <sup>4</sup>	0.30 in <sup>4</sup>	5,086 in <sup>4</sup>
Deck	556.4 in <sup>2</sup>	77.64 in	43,197.1 in <sup>3</sup>	193,625 in <sup>4</sup>	1,346 in <sup>4</sup>	194,971 in <sup>4</sup>
Total	1338.0 in <sup>2</sup>		72,325.2 in <sup>3</sup>			1,006,929 in <sup>4</sup>

Total area of Composite Section	$A_c =$	1338 in <sup>2</sup>
Overall Depth of the Composite Section	$h_c =$	80 in
Moment of Inertia	$I_c =$	1,006,929 in <sup>4</sup>
Distance from centroid to extreme <u>bottom</u> fiber of beam	$y_{bc} =$	54.06 in
Distance from centroid to extreme <u>top</u> fiber of beam	$y_{tc} =$	17.94 in
Distance from centroid to extreme <u>top</u> fiber of slab	$y_{ts} =$	25.94 in
Section modulus for the extreme <u>bottom</u> fiber of beam	$S_{bc} =$	18,627.8 in <sup>3</sup>
Section modulus for the extreme <u>top</u> fiber of beam	$S_{tc} =$	56,112.1 in <sup>3</sup>
Section modulus for the extreme <u>top</u> fiber slab	$S_{ts} =$	38,810.2 in <sup>3</sup>

### Shear Forces and Bending Moments

#### DEAD LOADS

Beam self-weight	$W_{beam} =$	0.799 k/f
8 in. deck weight	$W_{deck} =$	1.200 k/f
1/2 in. haunch weight	$W_{haunch} =$	0.022 k/f

#### LRFD Specifications: Art. 4.6.2.2.1

Width of Deck Constant		OK
Number of beams is not less than four $N_b =$	4	OK
Roadway part of the overhang, $d_o \leq 3.0$ ft, $d_o =$	1.5	OK
Curvature in plans is less than $4^\circ =$	0	OK
Cross-section of the bridge is consistent with one of the cross sections given by LRFD specs		OK

Barrier and wearing surface loads are equally distributed among the 4 beams

Barrier Wt	$W_t =$	0.150 k/f
Dead load of future wearing surface	$DW =$	0.263 k/f

LIVE LOADS		
Fire truck live load front load (Point A)	$P_{live} =$	48.0 kips
Fire truck live load back load (Point B)	$P_{live} =$	22.0 kips
distance between two loads		19.2 ft
distance from nearest edge to point A	$x_a =$	59.0 ft
distance from nearest edge to point B	$x_b =$	39.8 ft
LRFD Specifications: Art. 4.6.2.2.1		
Width of Deck Constant		OK
Number of beams is not less than four $N_b =$	4	OK
Beams are parallel and approximately of the same stiffness		OK
Roadway part of the overhang, $d_o \leq 3.0$ ft, $d_o =$	1.5	OK
Curvature in plans is less than $4^\circ =$	0	OK

Barrier and wearing surface loads are equally distributed among the 4 beams

Bridge Type-- "k" (LRFD Table 4.6.2.2.1-1)

Number of design lanes = w/12	=	3 lanes
-------------------------------	---	---------

**Distribution Factor for Bending Moment:**

Beams spacing	S =	12.0 ft
Depth of concrete slab	$t_s =$	7.5 in
Beam Span	L =	120.0 ft
Number of Beams	$N_b =$	4
Modular ratio between beam & deck materials	n =	1.4370
Longitudinal stiffness parameter	$K_B =$	2,508,620.36 in <sup>4</sup>

at center span:

$$DFM = 0.75 + \left(\frac{S}{9.5}\right)^{0.6} * \left(\frac{S}{L}\right)^{0.2} * \left(\frac{K_B}{12 * L * t_s^3}\right)^{0.1}$$

DFM =	0.911 lanes/beam
-------	------------------

0.905 Controls

one design lane loaded:

$$DFM = 0.75 + \left(\frac{S}{14}\right)^{0.4} * \left(\frac{S}{L}\right)^{0.2} * \left(\frac{K_B}{12 * L * t_s^3}\right)^{0.1}$$

DFM =	0.618 lanes/beam
-------	------------------

**Distribution Factor for Shear Force**

both end spans and center span:

$$DFV = 0.2 + \left(\frac{S}{12}\right) - \left(\frac{S}{35}\right)^2$$

DFV =	1.082 lanes/beam
-------	------------------

1.082 Controls

one design lane loaded:

$$DFV = 0.36 + \left(\frac{S}{25}\right)$$

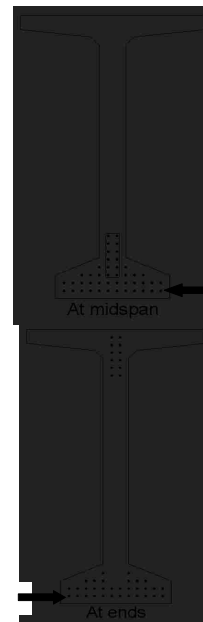
DFV =	0.840 lanes/beam
-------	------------------

	At Midspan		At Ends	
from bottom	No. of	Distance from Bottom	No. of	Distance from Bottom
layer 1	12	2	12	2
layer 2	12	4	12	4
layer 3	8	6	6	6
layer 4	4	8	2	8
layer 5	2	10	-	-
layer 6	2	12	-	-
layer 7	2	14	-	-
layer 8	2	16	-	-
layer 9	-	-	2	60
layer 10	-	-	2	62
layer 11	-	-	2	64
layer 12	-	-	2	66
layer 13	-	-	2	68
layer 14	-	-	2	70
<b>Harped Strand Group (included in above totals)</b>				
layer 3	2	6		
layer 4	2	8		
layer 5	2	10		
layer 6	2	12		
layer 7	2	14		
layer 8	2	16		

distance from the center of gravity of strands to the bottom fiber of the beam = 7% of the beam depth

strand eccentricity at midspan =  $(y_c - y_{bs})$

$y_{bs} =$	5.82 in
$e_c =$	30.78 in



**Prestress Losses**

**ELASTIC SHORTENING**

assumed loss	=	9.00%
Force per strand at transfer		
layer 1	=	28.9 kips
layer 2	=	28.9 kips
layer 3	=	28.9 kips
layer 4	=	28.9 kips
layer 5	=	28.9 kips
layer 6	=	28.9 kips
layer 7	=	28.9 kips
layer 8	=	28.9 kips
layer 9	=	28.9 kips
layer 10	=	28.9 kips
layer 11	=	28.9 kips
layer 12	=	28.9 kips
layer 13	=	28.9 kips
layer 14	=	28.9 kips

Total prestressing force at release	$P_i =$	at midspan 1271.6 kips	at endspan 1271.6 kips
	Sum of concrete stresses at the center of gravity of prestressing tendons due to prestressing force at transfer and the self-weight of the member at sections of maximum moment $f_{cgp} =$	2.938 ksi	2.938 ksi
Loss due to shortening		at midspan	at endspan
	layer 1 $\Delta f_{PES} =$	17.0 ksi	17.0 ksi
layer 2 $\Delta f_{PES} =$	17.0 ksi	17.0 ksi	17.0 ksi
layer 3 $\Delta f_{PES} =$	17.0 ksi	17.0 ksi	17.0 ksi
layer 4 $\Delta f_{PES} =$	17.0 ksi	17.0 ksi	17.0 ksi
layer 5 $\Delta f_{PES} =$	17.0 ksi		
layer 6 $\Delta f_{PES} =$	17.0 ksi		
layer 7 $\Delta f_{PES} =$	17.0 ksi		
layer 8 $\Delta f_{PES} =$	17.0 ksi		
layer 9 $\Delta f_{PES} =$			17.0 ksi
layer 10 $\Delta f_{PES} =$			17.0 ksi
layer 11 $\Delta f_{PES} =$			17.0 ksi
layer 12 $\Delta f_{PES} =$			17.0 ksi
layer 13 $\Delta f_{PES} =$			17.0 ksi
layer 14 $\Delta f_{PES} =$			17.0 ksi

**SHRINKAGE**

Shrinkage = (17-0.15*Relative Humidity)	$\Delta f_{PSR} =$	6.5 ksi	← assume relative humidity = 70%
---	--------------------	---------	----------------------------------

**CREEP OF CONCRETE**

Change of stresses at center of gravity of prestressing due to permanent loads except the loads acting at time of applying prestressing force, calculated at the same section as $f_{cgp}$	$\Delta f_{cdp} =$	1.566 ksi	
	loss due to creep $\Delta f_{PCR} =$	at midspan 24.3 ksi	at endspan 24.3 ksi

**RELAXATION OF PRESTRESSING STRANDS**

loss due to relaxation after transfer		at midspan	at endspan
	layer 1 $\Delta f_{PR2} =$	2.1 ksi	2.1 ksi
layer 2 $\Delta f_{PR2} =$	2.1 ksi	2.1 ksi	2.1 ksi
layer 3 $\Delta f_{PR2} =$	2.1 ksi	2.1 ksi	2.1 ksi
layer 4 $\Delta f_{PR2} =$	2.1 ksi	2.1 ksi	2.1 ksi
layer 5 $\Delta f_{PR2} =$	2.1 ksi		
layer 6 $\Delta f_{PR2} =$	2.1 ksi		
layer 7 $\Delta f_{PR2} =$	2.1 ksi		
layer 8 $\Delta f_{PR2} =$	2.1 ksi		
layer 9 $\Delta f_{PR2} =$			2.1 ksi
layer 10 $\Delta f_{PR2} =$			2.1 ksi
layer 11 $\Delta f_{PR2} =$			2.1 ksi
layer 12 $\Delta f_{PR2} =$			2.1 ksi
layer 13 $\Delta f_{PR2} =$			2.1 ksi
layer 14 $\Delta f_{PR2} =$			2.1 ksi

**TOTAL LOSSES AT TRANSFER**

total loss  $\Delta f_{pES} = \Delta f_{pi}$

stress in tendons after transfer  $f_{pi} = f_{pr} - \Delta f_{pi}$

		at midspan	at endspan
layer 1	$f_{pi} =$	190.6 ksi	190.6 ksi
layer 2	$f_{pi} =$	190.6 ksi	190.6 ksi
layer 3	$f_{pi} =$	190.6 ksi	190.6 ksi
layer 4	$f_{pi} =$	190.6 ksi	190.6 ksi
layer 5	$f_{pi} =$	190.6 ksi	
layer 6	$f_{pi} =$	190.6 ksi	
layer 7	$f_{pi} =$	190.6 ksi	
layer 8	$f_{pi} =$	190.6 ksi	
layer 9	$f_{pi} =$		190.6 ksi
layer 10	$f_{pi} =$		190.6 ksi
layer 11	$f_{pi} =$		190.6 ksi
layer 12	$f_{pi} =$		190.6 ksi
layer 13	$f_{pi} =$		190.6 ksi
layer 14	$f_{pi} =$		190.6 ksi

force per strand =  $f_{pi}$  \* strand area

		at midspan	at endspan
layer 1	=	29.2 kips	29.2 kips
layer 2	=	29.2 kips	29.2 kips
layer 3	=	29.2 kips	29.2 kips
layer 4	=	29.2 kips	29.2 kips
layer 5	=	29.2 kips	
layer 6	=	29.2 kips	
layer 7	=	29.2 kips	
layer 8	=	29.2 kips	
layer 9	=		29.2 kips
layer 10	=		29.2 kips
layer 11	=		29.2 kips
layer 12	=		29.2 kips
layer 13	=		29.2 kips
layer 14	=		29.2 kips
Total prestressing force after transfer	$P_i =$	1284.8 kips	1284.8 kips

Initial loss =  $(\Delta f_{pi}) / (f_{pi})$

		at midspan	at endspan
layer 1	% =	8.2%	8.2%
layer 2	% =	8.2%	8.2%
layer 3	% =	8.2%	8.2%
layer 4	% =	8.2%	8.2%
layer 5	% =	8.2%	
layer 6	% =	8.2%	
layer 7	% =	8.2%	
layer 8	% =	8.2%	
layer 9	% =		8.2%
layer 10	% =		8.2%
layer 11	% =		8.2%
layer 12	% =		8.2%
layer 13	% =		8.2%
layer 14	% =		8.2%

OK  
OK  
OK  
OK  
OK  
OK  
OK  
OK  
OK  
OK  
OK  
OK  
OK  
OK

**TOTAL LOSSES AT SERVICE LOADS**

Total Losses

		at midspan	at endspan
layer 1	$\Delta f_{pT} =$	49.9 ksi	49.9 ksi
layer 2	$\Delta f_{pT} =$	49.9 ksi	49.9 ksi
layer 3	$\Delta f_{pT} =$	49.9 ksi	49.9 ksi
layer 4	$\Delta f_{pT} =$	49.9 ksi	49.9 ksi
layer 5	$\Delta f_{pT} =$	49.9 ksi	
layer 6	$\Delta f_{pT} =$	49.9 ksi	
layer 7	$\Delta f_{pT} =$	49.9 ksi	
layer 8	$\Delta f_{pT} =$	49.9 ksi	
layer 9	$\Delta f_{pT} =$		49.9 ksi
layer 10	$\Delta f_{pT} =$		49.9 ksi
layer 11	$\Delta f_{pT} =$		49.9 ksi
layer 12	$\Delta f_{pT} =$		49.9 ksi
layer 13	$\Delta f_{pT} =$		49.9 ksi
layer 14	$\Delta f_{pT} =$		49.9 ksi



Stress in tendon after all losses =  $f_{pe} - \Delta f_{pt}$

		at midspan	at endspan
layer 1	$f_{pe} =$	157.7 ksi	157.7 ksi
layer 2	$f_{pe} =$	157.7 ksi	157.7 ksi
layer 3	$f_{pe} =$	157.7 ksi	157.7 ksi
layer 4	$f_{pe} =$	157.7 ksi	157.7 ksi
layer 5	$f_{pe} =$	157.7 ksi	
layer 6	$f_{pe} =$	157.7 ksi	
layer 7	$f_{pe} =$	157.7 ksi	
layer 8	$f_{pe} =$	157.7 ksi	
layer 9	$f_{pe} =$		157.7 ksi
layer 10	$f_{pe} =$		157.7 ksi
layer 11	$f_{pe} =$		157.7 ksi
layer 12	$f_{pe} =$		157.7 ksi
layer 13	$f_{pe} =$		157.7 ksi
layer 14	$f_{pe} =$		157.7 ksi

check prestressing stress limit at service limit state:  $f_{pe} \leq 0.8 \cdot f_{py}$

layer 1	=	199.7 ksi
layer 2	=	199.7 ksi
layer 3	=	199.7 ksi
layer 4	=	199.7 ksi
layer 5	=	199.7 ksi
layer 6	=	199.7 ksi
layer 7	=	199.7 ksi
layer 8	=	199.7 ksi
layer 9	=	199.7 ksi
layer 10	=	199.7 ksi
layer 11	=	199.7 ksi
layer 12	=	199.7 ksi
layer 13	=	199.7 ksi
layer 14	=	199.7 ksi

OK  
OK  
OK  
OK  
OK  
OK  
OK  
OK  
OK  
OK  
OK  
OK  
OK  
OK

force per strand =  $f_{pe} \cdot \text{strand area}$

		at midspan	at endspan
layer 1	=	24.1 kips	24.1 kips
layer 2	=	24.1 kips	24.1 kips
layer 3	=	24.1 kips	24.1 kips
layer 4	=	24.1 kips	24.1 kips
layer 5	=	24.1 kips	
layer 6	=	24.1 kips	
layer 7	=	24.1 kips	
layer 8	=	24.1 kips	
layer 9	=		24.1 kips
layer 10	=		24.1 kips
layer 11	=		24.1 kips
layer 12	=		24.1 kips
layer 13	=		24.1 kips
layer 14	=		24.1 kips

Total prestressing force after all losses

		at midspan	at endspan
$P_{pe} =$		1061.7 kips	1061.7 kips

Final losses, % =  $(\Delta f_{pt}) / (f_{pi})$

layer 1	% =	24.0%	24.0%
layer 2	% =	24.0%	24.0%
layer 3	% =	24.0%	24.0%
layer 4	% =	24.0%	24.0%
layer 5	% =	24.0%	
layer 6	% =	24.0%	
layer 7	% =	24.0%	
layer 8	% =	24.0%	
layer 9	% =		24.0%
layer 10	% =		24.0%
layer 11	% =		24.0%
layer 12	% =		24.0%
layer 13	% =		24.0%
layer 14	% =		24.0%
Average final losses, %	% =	24.0%	24.0%

### Stresses at Transfer

#### STRESS LIMITS FOR CONCRETE

Compression = $0.6f_{ci}$	$f_{ci} =$	3.300 ksi
Tension		
without bonded reinforcement = $-0.0948 \sqrt{f_{ci}} \leq -0.2$	=	-0.200 ksi
with bonded auxiliary reinforcement = $-0.22 \sqrt{f_{ci}}$	=	-0.016 ksi

#### STRESSES AT TRANSFER LENGTH SECTION

Transfer Length = $60 \times (\text{strand diameter})$	=	2.5 ft	} Calcs for eccentricity (see 9.6.7.2)
Bending moment at transfer length	$M_D =$	116.4 ft-kips	
center of 12 strands to top fiber of beam at the end	=	7.00 in	
center of 12 strands to bottom fiber of beam at the harp point	=	11.00 in	
center of 12 strands and top fiber of beam at transfer length	=	10.78 in	
center of gravity of 32 strands and bottom fiber of beam	=	3.88 in	
center of gravity of all strands and the bottom fiber of beam at transfer length	=	19.51 in	
center of gravity of all strands and the bottom fiber of beam at the end	=	20.55 in	
Eccentricity of the strand group at transfer length:	$e_n =$	17.09 in	
Eccentricity at end of beam:	$e =$	16.05 in	

$$f_t = \frac{P_i}{A} - \frac{P_i e}{S_t} + \frac{M_D}{S_t}$$

$$f_b = \frac{P_i}{A} + \frac{P_i e}{S_b} - \frac{M_D}{S_b}$$

		at midspan	at endspan	
Top stress at top fiber of beam	$f_t =$	0.342 ksi	0.342 ksi	OK
Bottom stress at bottom fiber of the beam	$f_b =$	3.021 ksi	3.021 ksi	OK

#### STRESSES AT HARP POINT

Bending moment due to beam weight at 0.3L	$M_D =$	1188.0 ft-kips		
Top stress at top fiber of beam	$f_t =$	0.035 ksi	0.035 ksi	OK
Bottom stress at bottom fiber of the beam	$f_b =$	3.300 ksi	3.300 ksi	OK

#### STRESSES AT MIDSPAN

Bending moment due to beam weight at 0.5L	$M_D =$	1414.3 ft-kips		
Top stress at top fiber of beam	$f_t =$	0.220 ksi	0.211 ksi	OK
Bottom stress at bottom fiber of the beam	$f_b =$	3.144 ksi	3.189 ksi	OK

#### HOLD-DOWN FORCES

assume stress in strand before losses =  $0.8f_u$

layer 1	=	221.4 ksi
layer 2	=	221.4 ksi
layer 3	=	221.4 ksi
layer 4	=	221.4 ksi
layer 5	=	221.4 ksi
layer 6	=	221.4 ksi
layer 7	=	221.4 ksi
layer 8	=	221.4 ksi
layer 9	=	221.4 ksi
layer 10	=	221.4 ksi
layer 11	=	221.4 ksi
layer 12	=	221.4 ksi
layer 13	=	221.4 ksi
layer 14	=	221.4 ksi

prestress force per strand before any losses:

layer 1	=	33.9 kips
layer 2	=	33.9 kips
layer 3	=	33.9 kips
layer 4	=	33.9 kips
layer 5	=	33.9 kips
layer 6	=	33.9 kips
layer 7	=	33.9 kips
layer 8	=	33.9 kips
layer 9	=	33.9 kips
layer 10	=	33.9 kips
layer 11	=	33.9 kips
layer 12	=	33.9 kips
layer 13	=	33.9 kips
layer 14	=	33.9 kips
Harp Angle	$\psi =$	7.2°

Hold-down force/strand

layer 1	=	4.4 kips/strand
layer 2	=	4.4 kips/strand
layer 3	=	4.4 kips/strand
layer 4	=	4.4 kips/strand
layer 5	=	4.4 kips/strand
layer 6	=	4.4 kips/strand
layer 7	=	4.4 kips/strand
layer 8	=	4.4 kips/strand
layer 9	=	4.4 kips/strand
layer 10	=	4.4 kips/strand
layer 11	=	4.4 kips/strand
layer 12	=	4.4 kips/strand
layer 13	=	4.4 kips/strand
layer 14	=	4.4 kips/strand
Total hold-down force	=	53.39 kips

**Stresses at Service Loads**

**STRESS LIMITS FOR CONCRETE**

**Compression:**

Due to permanent loads for load combination Service I

for the precast beam	=	3.150 ksi
for deck	=	1.526 ksi

Due to permanent and transient loads for load combination Service I

for the precast beam	=	4.200 ksi
for deck	=	2.034 ksi

**Tension:**

Load Combination Service III

for the precast beam	=	-0.016 ksi
----------------------	---	------------

**STRESSES AT MIDSPAN**

Compression stresses at top fiber of beam	at midspan	at endspan	
$f_t = \frac{P_{ps}}{A} - \frac{P_{ps}e}{S_t} + \frac{(M_g + M_s)}{S_t} + \frac{(M_{ws} + M_d)}{S_{tr}}$			
Due to permanent loads	$f_{t9} =$	2.046 ksi	2.046 ksi
$f_{tr} = \frac{P_{ps}}{A} - \frac{P_{ps}e}{S_t} + \frac{(M_g + M_s)}{S_t} + \frac{(M_{ws} + M_d)}{S_{tr}} + \frac{(M_{LL+I})}{S_{tr}}$			
Due to permanent loads and transient loads	$f_{t9} =$	2.508 ksi	2.508 ksi
<b>Compression stresses at top fiber of deck</b>	<b>at midspan</b>	<b>at endspan</b>	
$f_{tc} = \frac{(M_{ws} + M_d)}{S_{tr}}$			
Due to permanent loads	$f_{tc} =$	0.044 ksi	0.044 ksi
$f_{tc} = \frac{(M_{ws} + M_d + M_{LL+I})}{S_{tr}}$			
Due to permanent loads and transient loads	$f_{tc} =$	0.502 ksi	0.502 ksi
<b>Tension stresses at top fiber of deck</b>	<b>at midspan</b>	<b>at endspan</b>	
$f_{tr} = \frac{P_{ps}}{A} - \frac{P_{ps}e}{S_t} - \frac{(M_g + M_s)}{S_t} - \frac{(M_{ws} + M_d + C.8 * M_{LL+I})}{S_{tr}}$			
Load Combination Service III	$f_b =$	-0.430 ksi	-0.430 ksi

OK

OK

OK

OK

OK

**Strength Limit State**

**POSITIVE MOMENT SECTION**

$M_u = 1.25DC+1.5DW+1.75(LL+IM)$	$M_u =$	8381.5 ft-kips
----------------------------------	---------	----------------

effective length factor for compression members

layer 1	k =	0.28
layer 2	k =	0.28
layer 3	k =	0.28
layer 4	k =	0.28
layer 5	k =	0.28
layer 6	k =	0.28
layer 7	k =	0.28
layer 8	k =	0.28
layer 9	k =	0.28
layer 10	k =	0.28
layer 11	k =	0.28
layer 12	k =	0.28
layer 13	k =	0.28
layer 14	k =	0.28
	c =	6.7 ft-kips

average stress in prestressing steel

layer 1	$f_{ps} =$	269.9 ksi
layer 2	$f_{ps} =$	269.9 ksi
layer 3	$f_{ps} =$	269.9 ksi
layer 4	$f_{ps} =$	269.9 ksi
layer 5	$f_{ps} =$	269.9 ksi
layer 6	$f_{ps} =$	269.9 ksi
layer 7	$f_{ps} =$	269.9 ksi
layer 8	$f_{ps} =$	269.9 ksi
layer 9	$f_{ps} =$	269.9 ksi
layer 10	$f_{ps} =$	269.9 ksi
layer 11	$f_{ps} =$	269.9 ksi
layer 12	$f_{ps} =$	269.9 ksi
layer 13	$f_{ps} =$	269.9 ksi
layer 14	$f_{ps} =$	269.9 ksi

nominal flexure resistance

	a =	5.70 in
$M_r = \phi M_n, \phi = 1.00$	$\phi M_n =$	10800.2 ft-kips
M=DC+W+LL+IM	M =	5833.6 ft-kips

OK  
OK

**NEGATIVE MOMENT SECTION**

$M_u = 1.25DC+1.5DW+1.75(LL+IM)$	$M_u =$	-4837.2 ft-kips
----------------------------------	---------	-----------------

	a =	5.60 in
	$\phi M_n =$	4606.8 ft-kips
M=DC+W+LL+IM	M =	-2869.7 ft-kips

NOT OK  
OK

## Shear Design

CRITICAL SECTION AT 0.59		
$V_u = 1.25DC + 1.5DW + 1.75(LL + IM)$	$V_u =$	405.0 kips
$M_u = 1.25DC + 1.5DW + 1.75(LL + IM)$	$M_u =$	-2684.4 ft-kips
or		
$V_u = 1.25DC + 1.5DW + 1.75(LL + IM)$	$V_u =$	364.8 kips
$M_u = 1.25DC + 1.5DW + 1.75(LL + IM)$	$M_u =$	-2877.0 ft-kips
max shear	$V_u =$	405.0 kips
max moment	$M_u =$	2877.0 ft-kips
Shear depth	$d_v =$	73.19 in
Applied factored normal force at the section	$N_u =$	0
Angle of diagonal compressive stresses	$\theta =$	36.00 °

### STRAIN IN FLEXURAL TENSION REINFORCEMENT

$$\epsilon_x = \frac{\frac{M_u}{d_v} + 0.5N_u + 0.5V_u \cot \theta - A_{ps}f_{ps}}{E_s A_s + E_p A_{ps}} \leq 0.002$$

	at midspan	at endspan	
resultant compressive stress at centroid	$f_{pc} =$	1.024 ksi	1.024 ksi

effective stress in prestressing strand after all losses

layer 1	$f_{po} =$	163.0 ksi	163.0 ksi
layer 2	$f_{po} =$	163.0 ksi	163.0 ksi
layer 3	$f_{po} =$	163.0 ksi	163.0 ksi
layer 4	$f_{po} =$	163.0 ksi	163.0 ksi
layer 5	$f_{po} =$	163.0 ksi	
layer 6	$f_{po} =$	163.0 ksi	
layer 7	$f_{po} =$	163.0 ksi	
layer 8	$f_{po} =$	163.0 ksi	
layer 9	$f_{po} =$		163.0 ksi
layer 10	$f_{po} =$		163.0 ksi
layer 11	$f_{po} =$		163.0 ksi
layer 12	$f_{po} =$		163.0 ksi
layer 13	$f_{po} =$		163.0 ksi
layer 14	$f_{po} =$		163.0 ksi

strain in flexural tension

	at midspan	at endspan	
layer 1	$\epsilon_x =$	0.002000	0.002000
layer 2	$\epsilon_x =$	0.002000	0.002000
layer 3	$\epsilon_x =$	0.002000	0.002000
layer 4	$\epsilon_x =$	0.002000	0.002000
layer 5	$\epsilon_x =$	0.002000	
layer 6	$\epsilon_x =$	0.002000	
layer 7	$\epsilon_x =$	0.002000	
layer 8	$\epsilon_x =$	0.002000	
layer 9	$\epsilon_x =$		0.002000
layer 10	$\epsilon_x =$		0.002000
layer 11	$\epsilon_x =$		0.002000
layer 12	$\epsilon_x =$		0.002000
layer 13	$\epsilon_x =$		0.002000
layer 14	$\epsilon_x =$		0.002000

## Deflection and Camber

	at midspan	at endspan	
Deflection due to Prestressing Force at Transfer	$\Delta_p =$	3.97 in	3.97 in
Deflection due to Beam Self-Weight at Transfer	$\Delta_{q1} =$	-1.49 in	
Deflection due to Beam Self-Weight at Erection	$\Delta_{q2} =$	-1.44 in	
Deflection due to Haunch and Deck	$\Delta_g =$	-1.95 in	

Deflection due to total self weight

$\Delta_{sw} =$	0.59 in
-----------------	---------

Total Deflection at transfer

$\Delta =$	2.48 in	2.48 in
------------	---------	---------

Total Deflection at erection

$\Delta =$	4.49 in	4.49 in
------------	---------	---------

Live load deflection limit = span/800

$=$	1.80 in
-----	---------

Deflection due to live load and impact

$\Delta_L =$	-0.86 in
--------------	----------

OK

Deflection due to fire truck

$\Delta_L =$	-0.7747 in
--------------	------------

OK

Total Deflection after fire with fire truck

$\Delta =$	3.7806 in
------------	-----------

**Location: Fire at Critical Negative Moment Sections**  
**Beam Design: 1/2" Strand**  
**Fire Exposure Status: 2 Hour**

(PCI Bridge Design Manual Section 9.6)



**Material Properties**

CAST-IN-PLACE SLAB		
Actual Thickness	$t_{as} =$	8.0 in
Wearing Surface	=	0.5 in
Structural thickness = Actual - Wearing Surface	$t_s =$	7.5 in
Compressive Strength	$f'_c =$	3.25 ksi
Unit Weight	$w_c =$	150.0 pcf
Stress factor of compression block	$\beta_1 =$	0.85

BEAMS: AASHTO-PCI, BT-72 BULB-TEE		
Strength at release	$f'_{ci} =$	5.5 ksi
Strength at 28 days	$f'_c =$	7 ksi
Unit Weight	$w_c =$	150.0 pcf
Overall Beam Length:		
@ end spans	L =	110 ft
@ center span	L =	119 ft
Design Spans:		
Non-composite beam @ end spans	L =	109 ft
Non-composite beam @ center span	L =	118 ft
Composite beam @ end spans	L =	110 ft
Composite beam @ center span	L =	120 ft
Beam Spacing	S =	12 ft



**PRESTRESSING STRANDS**

Diameter of single strand	d =	0.5 in
Area of single strand	A =	0.153 in <sup>2</sup>

Temperature of Layer

layer 1 (bottom)	T =	68.00 °F
layer 2	T =	68.00 °F
layer 3	T =	68.00 °F
layer 4	T =	68.00 °F
layer 5	T =	68.00 °F
layer 6	T =	68.00 °F
layer 7	T =	68.00 °F
layer 8	T =	68.00 °F
layer 9	T =	68.00 °F
layer 10	T =	68.00 °F
layer 11	T =	68.00 °F
layer 12	T =	68.00 °F
layer 13	T =	68.00 °F
layer 14	T =	68.00 °F

Ultimate Strength

initial = 277 ksi

layer 1 (bottom)	f <sub>pu</sub> =	277 ksi
layer 2	f <sub>pu</sub> =	277 ksi
layer 3	f <sub>pu</sub> =	277 ksi
layer 4	f <sub>pu</sub> =	277 ksi
layer 5	f <sub>pu</sub> =	277 ksi
layer 6	f <sub>pu</sub> =	277 ksi
layer 7	f <sub>pu</sub> =	277 ksi
layer 8	f <sub>pu</sub> =	277 ksi
layer 9	f <sub>pu</sub> =	277 ksi
layer 10	f <sub>pu</sub> =	277 ksi
layer 11	f <sub>pu</sub> =	277 ksi
layer 12	f <sub>pu</sub> =	277 ksi
layer 13	f <sub>pu</sub> =	277 ksi
layer 14	f <sub>pu</sub> =	277 ksi

Yield Strength

initial = 250 ksi

layer 1 (bottom)	f <sub>py</sub> =	250 ksi
layer 2	f <sub>py</sub> =	250 ksi
layer 3	f <sub>py</sub> =	250 ksi
layer 4	f <sub>py</sub> =	250 ksi
layer 5	f <sub>py</sub> =	250 ksi
layer 6	f <sub>py</sub> =	250 ksi
layer 7	f <sub>py</sub> =	250 ksi
layer 8	f <sub>py</sub> =	250 ksi
layer 9	f <sub>py</sub> =	250 ksi
layer 10	f <sub>py</sub> =	250 ksi
layer 11	f <sub>py</sub> =	250 ksi
layer 12	f <sub>py</sub> =	250 ksi
layer 13	f <sub>py</sub> =	250 ksi
layer 14	f <sub>py</sub> =	250 ksi

Stress Limits:

before transfer ≤ 0.75f<sub>pu</sub> (initial = 207.6)

layer 1 (bottom)	f <sub>pi</sub> =	207.6 ksi
layer 2	f <sub>pi</sub> =	207.6 ksi
layer 3	f <sub>pi</sub> =	207.6 ksi
layer 4	f <sub>pi</sub> =	207.6 ksi
layer 5	f <sub>pi</sub> =	207.6 ksi
layer 6	f <sub>pi</sub> =	207.6 ksi
layer 7	f <sub>pi</sub> =	207.6 ksi
layer 8	f <sub>pi</sub> =	207.6 ksi
layer 9	f <sub>pi</sub> =	207.6 ksi
layer 10	f <sub>pi</sub> =	207.6 ksi
layer 11	f <sub>pi</sub> =	207.6 ksi
layer 12	f <sub>pi</sub> =	207.6 ksi
layer 13	f <sub>pi</sub> =	207.6 ksi
layer 14	f <sub>pi</sub> =	207.6 ksi

at service limit state (after all losses)  $\leq 0.80f_{py}$  (initial = 199.7)

layer 1 (bottom)	$f_{pe} =$	199.7 ksi
layer 2	$f_{pe} =$	199.7 ksi
layer 3	$f_{pe} =$	199.7 ksi
layer 4	$f_{pe} =$	199.7 ksi
layer 5	$f_{pe} =$	199.7 ksi
layer 6	$f_{pe} =$	199.7 ksi
layer 7	$f_{pe} =$	199.7 ksi
layer 8	$f_{pe} =$	199.7 ksi
layer 9	$f_{pe} =$	199.7 ksi
layer 10	$f_{pe} =$	199.7 ksi
layer 11	$f_{pe} =$	199.7 ksi
layer 12	$f_{pe} =$	199.7 ksi
layer 13	$f_{pe} =$	199.7 ksi
layer 14	$f_{pe} =$	199.7 ksi

Modulus of Elasticity

initial = 25982 ksi

layer 1 (bottom)	E =	25982.0 ksi
layer 2	E =	25982.0 ksi
layer 3	E =	25982.0 ksi
layer 4	E =	25982.0 ksi
layer 5	E =	25982.0 ksi
layer 6	E =	25982.0 ksi
layer 7	E =	25982.0 ksi
layer 8	E =	25982.0 ksi
layer 9	E =	25982.0 ksi
layer 10	E =	25982.0 ksi
layer 11	E =	25982.0 ksi
layer 12	E =	25982.0 ksi
layer 13	E =	25982.0 ksi
layer 14	E =	25982.0 ksi

### MILD STEEL REINFORCING BARS

Yield Strength

Layer 1 (Bottom)	$f_y =$	60.0 ksi	68.00 °F
Layer 2 (Top)	$f_y =$	53.3 ksi	1120.00 °F

Modulus of Elasticity

E =	29000.0 ksi
-----	-------------

Layer 1 (Bottom)

Area of steel at midspan (effective flange)	$A_{sm} =$	2.79 in <sup>2</sup>
Area of steel at endspan (effective flange)	$A_{se} =$	2.48 in <sup>2</sup>
Area of temperature and shrinkage steel (12" width)	$A_s =$	0.31 in <sup>2</sup>

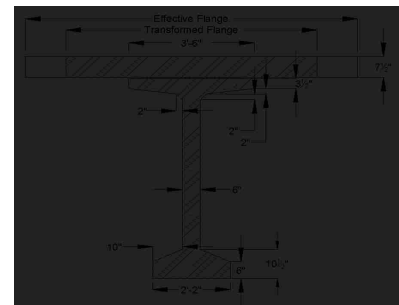
Layer 2 (Top)

Area of steel at midspan (effective flange)	$A_{sm} =$	12.6 in <sup>2</sup>
Area of steel at endspan (effective flange)	$A_{se} =$	12.4 in <sup>2</sup>
Area of temperature and shrinkage steel (12" width)	$A_s =$	0.2 in <sup>2</sup>

### Cross-sectional Properties

#### NON-COMPOSITE BEAM

Area of cross-section of beam	A =	767.0 in <sup>2</sup>
Overall depth of beam	H =	72.0 in
Moment of Inertia	I =	539,947 in <sup>4</sup>
Distance from centroid to extreme bottom fiber	$y_b =$	36.6 in
Distance from centroid to extreme top fiber	$y_t =$	35.4 in
Section modulus for the extreme bottom fiber	$S_b =$	14915.0 in <sup>3</sup>
Section modulus for the extreme top fiber	$S_t =$	15421.0 in <sup>3</sup>
Weight	$W_t =$	799.0 plf
Modulus of Elasticity = $33000 \cdot (W_c^{1.5}) \cdot (\sqrt{f_c})$		
cast-in-place concrete deck	$E_{cp} =$	3456 ksi
precast beam at release	$E_{pr} =$	4496 ksi
precast beam at service loads	$E_c =$	5072 ksi





### COMPOSITE BEAM AT MIDSPAN

Effective Flange Width	$b_f =$	111.0 in	*min of three criteria
Modular Ratio = $E_{cf}/E_c$	$n =$	0.6814	
Transformed flange width	$=$	75.6 in	
Transformed flange area	$=$	567.3 in <sup>2</sup>	
Transformed haunch width	$=$	28.6 in	
Transformed haunch area	$=$	14.3 in <sup>2</sup>	
Deck-distance to top fiber	$y_t =$	5.34 in	

	Transformed Area	$y_b$	$Ay_b$	$A(y_{bc}-y_b)^2$	I	$I + A(y_{bc}-y_b)^2$
Beam	767.0 in <sup>2</sup>	36.60 in	28,072.2 in <sup>3</sup>	205,982 in <sup>4</sup>	539,947 in <sup>4</sup>	745,929 in <sup>4</sup>
Haunch	14.3 in <sup>2</sup>	72.25 in	1,033.8 in <sup>3</sup>	5,309 in <sup>4</sup>	0.33 in <sup>4</sup>	5,310 in <sup>4</sup>
Deck	567.3 in <sup>2</sup>	74.66 in	42,351.1 in <sup>3</sup>	266,433 in <sup>4</sup>	1,163 in <sup>4</sup>	267,597 in <sup>4</sup>
Total	1348.6 in <sup>2</sup>		71,457.2 in <sup>3</sup>			1,018,835 in <sup>4</sup>

Total area of Composite Section	$A_c =$	1349 in <sup>2</sup>
Overall Depth of the Composite Section	$h_c =$	80 in
Moment of Inertia	$I_c =$	1,018,835 in <sup>4</sup>
Distance from centroid to extreme <u>bottom</u> fiber of beam	$y_{bc} =$	52.99 in
Distance from centroid to extreme <u>top</u> fiber of beam	$y_{tc} =$	19.01 in
Distance from centroid to extreme <u>top</u> fiber of slab	$y_{ts} =$	27.01 in
Section modulus for the extreme <u>bottom</u> fiber of beam	$S_{bc} =$	19,227.8 in <sup>3</sup>
Section modulus for the extreme <u>top</u> fiber of beam	$S_{tc} =$	53,588.1 in <sup>3</sup>
Section modulus for the extreme <u>top</u> fiber slab	$S_{ts} =$	55,354.0 in <sup>3</sup>

### COMPOSITE BEAM AT ENDSPAN

Effective Flange Width	$b_f =$	106.6 in	*min of three criteria
Modular Ratio = $E_{cf}/E_c$	$n =$	0.6814	
Transformed flange width	$=$	72.6 in	
Transformed flange area	$=$	544.8 in <sup>2</sup>	
Transformed haunch width	$=$	28.6 in	
Transformed haunch area	$=$	14.3 in <sup>2</sup>	
Deck-distance to top fiber	$y_{td} =$	5.34 in	

	Transformed Area	$y_t$	$Ay_t$	$A(y_{tc}-y_t)^2$	I	$I + A(y_{tc}-y_t)^2$
Beam	767.0 in <sup>2</sup>	36.60 in	28,072.2 in <sup>3</sup>	263,260 in <sup>4</sup>	539,947 in <sup>4</sup>	803,207 in <sup>4</sup>
Haunch	14.3 in <sup>2</sup>	72.25 in	1,033.8 in <sup>3</sup>	4,911 in <sup>4</sup>	0.30 in <sup>4</sup>	4,912 in <sup>4</sup>
Deck	544.8 in <sup>2</sup>	77.84 in	42,404.7 in <sup>3</sup>	186,982 in <sup>4</sup>	2,554 in <sup>4</sup>	189,536 in <sup>4</sup>
Total	1326.1 in <sup>2</sup>		71,510.7 in <sup>3</sup>			997,654 in <sup>4</sup>

Total area of Composite Section	$A_c =$	1326 in <sup>2</sup>
Overall Depth of the Composite Section	$h_c =$	80 in
Moment of Inertia	$I_c =$	997,654 in <sup>4</sup>
Distance from centroid to extreme <u>bottom</u> fiber of beam	$y_{bc} =$	53.93 in
Distance from centroid to extreme <u>top</u> fiber of beam	$y_{tc} =$	18.07 in
Distance from centroid to extreme <u>top</u> fiber of slab	$y_{ts} =$	26.07 in
Section modulus for the extreme <u>bottom</u> fiber of beam	$S_{bc} =$	18,500.2 in <sup>3</sup>
Section modulus for the extreme <u>top</u> fiber of beam	$S_{tc} =$	55,200.0 in <sup>3</sup>
Section modulus for the extreme <u>top</u> fiber slab	$S_{ts} =$	38,263.2 in <sup>3</sup>

### Shear Forces and Bending Moments

#### DEAD LOADS

Beam self-weight	$W_{beam} =$	0.799 k/f
8 in. deck weight	$W_{deck} =$	1.200 k/f
1/2 in. haunch weight	$W_{haunch} =$	0.022 k/f

#### LRFD Specifications: Art. 4.6.2.2.1

Width of Deck Constant		OK
Number of beams is not less than four $N_b =$	4	OK
Roadway part of the overhang, $d_o \leq 3.0$ ft, $d_o =$	1.5	OK
Curvature in plans is less than $4^\circ =$	0	OK
Cross-section of the bridge is consistent with one of the cross sections given by LRFD specs		OK

Barrier and wearing surface loads are equally distributed among the 4 beams

Barrier Wt	$W_t =$	0.150 k/f
Dead load of future wearing surface	$DW =$	0.263 k/f

LIVE LOADS		
Fire truck live load front load (Point A)	$P_{live} =$	48.0 kips
Fire truck live load back load (Point B)	$P_{live} =$	22.0 kips
distance between two loads		19.2 ft
distance from nearest edge to point A	$x_a =$	59.0 ft
distance from nearest edge to point B	$x_b =$	39.8 ft
LRFD Specifications: Art. 4.6.2.2.1		
Width of Deck Constant		OK
Number of beams is not less than four $N_b =$	4	OK
Beams are parallel and approximately of the same stiffness		OK
Roadway part of the overhang, $d_o \leq 3.0$ ft, $d_o =$	1.5	OK
Curvature in plans is less than $4^\circ =$	0	OK

Barrier and wearing surface loads are equally distributed among the 4 beams

Bridge Type-- "k" (LRFD Table 4.6.2.2.1-1)

Number of design lanes = w/12	=	3 lanes
-------------------------------	---	---------

**Distribution Factor for Bending Moment:**

Beams spacing	$S =$	12.0 ft
Depth of concrete slab	$t_s =$	7.5 in
Beam Span	$L =$	120.0 ft
Number of Beams	$N_b =$	4
Modular ratio between beam & deck materials	$n =$	1.4676
Longitudinal stiffness parameter	$K_y =$	2,562,082.51 in <sup>4</sup>

at center span:

$$DFM = 0.75 + \left(\frac{S}{9.5}\right)^{0.6} * \left(\frac{S}{L}\right)^{0.2} * \left(\frac{K_y}{12 * L * n * t_s^3}\right)^{0.1}$$

DFM =	0.913 lanes/beam
-------	------------------

0.905 Controls

one design lane loaded:

$$DFM = 0.75 + \left(\frac{S}{14}\right)^{0.4} * \left(\frac{S}{L}\right)^{0.2} * \left(\frac{K_y}{12 * L * n * t_s^3}\right)^{0.1}$$

DFM =	0.619 lanes/beam
-------	------------------

**Distribution Factor for Shear Force**

both end spans and center span:

$$DFV = 0.2 + \left(\frac{S}{12}\right) - \left(\frac{S}{35}\right)^2$$

DFV =	1.082 lanes/beam
-------	------------------

1.082 Controls

one design lane loaded:

$$DFV = 0.36 + \left(\frac{S}{25}\right)$$

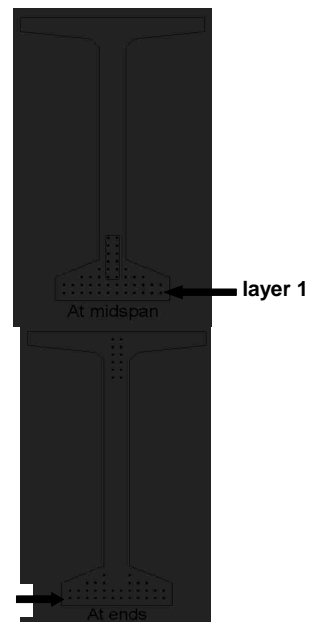
DFV =	0.840 lanes/beam
-------	------------------

	At Midspan		At Ends	
from bottom	No. of	Distance from Bottom	No. of	Distance from Bottom
layer 1	12	2	12	2
layer 2	12	4	12	4
layer 3	8	6	6	6
layer 4	4	8	2	8
layer 5	2	10	-	-
layer 6	2	12	-	-
layer 7	2	14	-	-
layer 8	2	16	-	-
layer 9	-	-	2	60
layer 10	-	-	2	62
layer 11	-	-	2	64
layer 12	-	-	2	66
layer 13	-	-	2	68
layer 14	-	-	2	70
<b>Harped Strand Group (included in above totals)</b>				
layer 3	2	6		
layer 4	2	8		
layer 5	2	10		
layer 6	2	12		
layer 7	2	14		
layer 8	2	16		

distance from the center of gravity of strands to the bottom fiber of the beam = 7% of the beam depth  
strand eccentricity at midspan =  $(y_c - y_{bs})$

$y_{bs} =$	5.82 in
$e_c =$	30.78 in

layer 1



**Prestress Losses**

**ELASTIC SHORTENING**

assumed loss	=	9.00%
Force per strand at transfer		
layer 1	=	28.9 kips
layer 2	=	28.9 kips
layer 3	=	28.9 kips
layer 4	=	28.9 kips
layer 5	=	28.9 kips
layer 6	=	28.9 kips
layer 7	=	28.9 kips
layer 8	=	28.9 kips
layer 9	=	28.9 kips
layer 10	=	28.9 kips
layer 11	=	28.9 kips
layer 12	=	28.9 kips
layer 13	=	28.9 kips
layer 14	=	28.9 kips

Total prestressing force at release	$P_i =$	at midspan 1271.6 kips	at endspan 1271.6 kips
	Sum of concrete stresses at the center of gravity of prestressing tendons due to prestressing force at transfer and the self-weight of the member at sections of maximum moment $f_{cgp} =$	2.938 ksi	2.938 ksi
Loss due to shortening		at midspan	at endspan
	layer 1 $\Delta f_{PES} =$	17.0 ksi	17.0 ksi
layer 2 $\Delta f_{PES} =$	17.0 ksi	17.0 ksi	
layer 3 $\Delta f_{PES} =$	17.0 ksi	17.0 ksi	
layer 4 $\Delta f_{PES} =$	17.0 ksi	17.0 ksi	
layer 5 $\Delta f_{PES} =$	17.0 ksi		
layer 6 $\Delta f_{PES} =$	17.0 ksi		
layer 7 $\Delta f_{PES} =$	17.0 ksi		
layer 8 $\Delta f_{PES} =$	17.0 ksi		
layer 9 $\Delta f_{PES} =$			17.0 ksi
layer 10 $\Delta f_{PES} =$			17.0 ksi
layer 11 $\Delta f_{PES} =$			17.0 ksi
layer 12 $\Delta f_{PES} =$			17.0 ksi
layer 13 $\Delta f_{PES} =$			17.0 ksi
layer 14 $\Delta f_{PES} =$			17.0 ksi

**SHRINKAGE**

Shrinkage = (17-0.15*Relative Humidity)	$\Delta f_{PSR} =$	6.5 ksi	← assume relative humidity = 70%
---	--------------------	---------	----------------------------------

**CREEP OF CONCRETE**

Change of stresses at center of gravity of prestressing due to permanent loads except the loads acting at time of applying prestressing force, calculated at the same section as $f_{cgp}$	$\Delta f_{cdp} =$	1.567 ksi	
	loss due to creep $\Delta f_{PCR} =$	at midspan 24.3 ksi	at endspan 24.3 ksi

**RELAXATION OF PRESTRESSING STRANDS**

loss due to relaxation after transfer		at midspan	at endspan
	layer 1 $\Delta f_{PR2} =$	2.1 ksi	2.1 ksi
layer 2 $\Delta f_{PR2} =$	2.1 ksi	2.1 ksi	
layer 3 $\Delta f_{PR2} =$	2.1 ksi	2.1 ksi	
layer 4 $\Delta f_{PR2} =$	2.1 ksi	2.1 ksi	
layer 5 $\Delta f_{PR2} =$	2.1 ksi		
layer 6 $\Delta f_{PR2} =$	2.1 ksi		
layer 7 $\Delta f_{PR2} =$	2.1 ksi		
layer 8 $\Delta f_{PR2} =$	2.1 ksi		
layer 9 $\Delta f_{PR2} =$			2.1 ksi
layer 10 $\Delta f_{PR2} =$			2.1 ksi
layer 11 $\Delta f_{PR2} =$			2.1 ksi
layer 12 $\Delta f_{PR2} =$			2.1 ksi
layer 13 $\Delta f_{PR2} =$			2.1 ksi
layer 14 $\Delta f_{PR2} =$			2.1 ksi

**TOTAL LOSSES AT TRANSFER**

total loss  $\Delta f_{pES} = \Delta f_{pi}$

stress in tendons after transfer  $f_{pi} = f_{pr} - \Delta f_{pi}$

		at midspan	at endspan
layer 1	$f_{pi} =$	190.6 ksi	190.6 ksi
layer 2	$f_{pi} =$	190.6 ksi	190.6 ksi
layer 3	$f_{pi} =$	190.6 ksi	190.6 ksi
layer 4	$f_{pi} =$	190.6 ksi	190.6 ksi
layer 5	$f_{pi} =$	190.6 ksi	
layer 6	$f_{pi} =$	190.6 ksi	
layer 7	$f_{pi} =$	190.6 ksi	
layer 8	$f_{pi} =$	190.6 ksi	
layer 9	$f_{pi} =$		190.6 ksi
layer 10	$f_{pi} =$		190.6 ksi
layer 11	$f_{pi} =$		190.6 ksi
layer 12	$f_{pi} =$		190.6 ksi
layer 13	$f_{pi} =$		190.6 ksi
layer 14	$f_{pi} =$		190.6 ksi

force per strand =  $f_{pi}$  \* strand area

		at midspan	at endspan
layer 1	=	29.2 kips	29.2 kips
layer 2	=	29.2 kips	29.2 kips
layer 3	=	29.2 kips	29.2 kips
layer 4	=	29.2 kips	29.2 kips
layer 5	=	29.2 kips	
layer 6	=	29.2 kips	
layer 7	=	29.2 kips	
layer 8	=	29.2 kips	
layer 9	=		29.2 kips
layer 10	=		29.2 kips
layer 11	=		29.2 kips
layer 12	=		29.2 kips
layer 13	=		29.2 kips
layer 14	=		29.2 kips
	$P_i =$	1284.8 kips	1284.8 kips

Total prestressing force after transfer

Initial loss =  $(\Delta f_{pi}) / (f_{pi})$

		at midspan	at endspan
layer 1	% =	8.2%	8.2%
layer 2	% =	8.2%	8.2%
layer 3	% =	8.2%	8.2%
layer 4	% =	8.2%	8.2%
layer 5	% =	8.2%	
layer 6	% =	8.2%	
layer 7	% =	8.2%	
layer 8	% =	8.2%	
layer 9	% =		8.2%
layer 10	% =		8.2%
layer 11	% =		8.2%
layer 12	% =		8.2%
layer 13	% =		8.2%
layer 14	% =		8.2%

OK  
OK  
OK  
OK  
OK  
OK  
OK  
OK  
OK  
OK  
OK  
OK  
OK  
OK

**TOTAL LOSSES AT SERVICE LOADS**

Total Losses

		at midspan	at endspan
layer 1	$\Delta f_{pT} =$	49.9 ksi	49.9 ksi
layer 2	$\Delta f_{pT} =$	49.9 ksi	49.9 ksi
layer 3	$\Delta f_{pT} =$	49.9 ksi	49.9 ksi
layer 4	$\Delta f_{pT} =$	49.9 ksi	49.9 ksi
layer 5	$\Delta f_{pT} =$	49.9 ksi	
layer 6	$\Delta f_{pT} =$	49.9 ksi	
layer 7	$\Delta f_{pT} =$	49.9 ksi	
layer 8	$\Delta f_{pT} =$	49.9 ksi	
layer 9	$\Delta f_{pT} =$		49.9 ksi
layer 10	$\Delta f_{pT} =$		49.9 ksi
layer 11	$\Delta f_{pT} =$		49.9 ksi
layer 12	$\Delta f_{pT} =$		49.9 ksi
layer 13	$\Delta f_{pT} =$		49.9 ksi
layer 14	$\Delta f_{pT} =$		49.9 ksi

Stress in tendon after all losses =  $f_{pe} - \Delta f_{pt}$

		at midspan	at endspan
layer 1	$f_{pe} =$	157.7 ksi	157.7 ksi
layer 2	$f_{pe} =$	157.7 ksi	157.7 ksi
layer 3	$f_{pe} =$	157.7 ksi	157.7 ksi
layer 4	$f_{pe} =$	157.7 ksi	157.7 ksi
layer 5	$f_{pe} =$	157.7 ksi	
layer 6	$f_{pe} =$	157.7 ksi	
layer 7	$f_{pe} =$	157.7 ksi	
layer 8	$f_{pe} =$	157.7 ksi	
layer 9	$f_{pe} =$		157.7 ksi
layer 10	$f_{pe} =$		157.7 ksi
layer 11	$f_{pe} =$		157.7 ksi
layer 12	$f_{pe} =$		157.7 ksi
layer 13	$f_{pe} =$		157.7 ksi
layer 14	$f_{pe} =$		157.7 ksi

check prestressing stress limit at service limit state:  $f_{pe} \leq 0.8 \cdot f_{py}$

layer 1	=	199.7 ksi
layer 2	=	199.7 ksi
layer 3	=	199.7 ksi
layer 4	=	199.7 ksi
layer 5	=	199.7 ksi
layer 6	=	199.7 ksi
layer 7	=	199.7 ksi
layer 8	=	199.7 ksi
layer 9	=	199.7 ksi
layer 10	=	199.7 ksi
layer 11	=	199.7 ksi
layer 12	=	199.7 ksi
layer 13	=	199.7 ksi
layer 14	=	199.7 ksi

OK  
OK  
OK  
OK  
OK  
OK  
OK  
OK  
OK  
OK  
OK  
OK  
OK  
OK

force per strand =  $f_{pe} \cdot \text{strand area}$

		at midspan	at endspan
layer 1	=	24.1 kips	24.1 kips
layer 2	=	24.1 kips	24.1 kips
layer 3	=	24.1 kips	24.1 kips
layer 4	=	24.1 kips	24.1 kips
layer 5	=	24.1 kips	
layer 6	=	24.1 kips	
layer 7	=	24.1 kips	
layer 8	=	24.1 kips	
layer 9	=		24.1 kips
layer 10	=		24.1 kips
layer 11	=		24.1 kips
layer 12	=		24.1 kips
layer 13	=		24.1 kips
layer 14	=		24.1 kips

Total prestressing force after all losses

		at midspan	at endspan
$P_{pe} =$		1061.8 kips	1061.8 kips

Final losses, % =  $(\Delta f_{pt}) / (f_{pi})$

layer 1	% =	24.0%	24.0%
layer 2	% =	24.0%	24.0%
layer 3	% =	24.0%	24.0%
layer 4	% =	24.0%	24.0%
layer 5	% =	24.0%	
layer 6	% =	24.0%	
layer 7	% =	24.0%	
layer 8	% =	24.0%	
layer 9	% =		24.0%
layer 10	% =		24.0%
layer 11	% =		24.0%
layer 12	% =		24.0%
layer 13	% =		24.0%
layer 14	% =		24.0%
Average final losses, %	% =	24.0%	24.0%

### Stresses at Transfer

#### STRESS LIMITS FOR CONCRETE

Compression = $0.6f_{ci}$	$f_{ci} =$	3.300 ksi
Tension		
without bonded reinforcement = $-0.0948 \sqrt{f_{ci}} \leq -0.2$	=	-0.200 ksi
with bonded auxiliary reinforcement = $-0.22 \sqrt{f_{ci}}$	=	-0.016 ksi

#### STRESSES AT TRANSFER LENGTH SECTION

Transfer Length = $60 \times (\text{strand diameter})$	=	2.5 ft	} Calcs for eccentricity (see 9.6.7.2)
Bending moment at transfer length	$M_D =$	116.4 ft-kips	
center of 12 strands to top fiber of beam at the end	=	7.00 in	
center of 12 strands to bottom fiber of beam at the harp point	=	11.00 in	
center of 12 strands and top fiber of beam at transfer length	=	10.78 in	
center of gravity of 32 strands and bottom fiber of beam	=	3.88 in	
center of gravity of all strands and the bottom fiber of beam at transfer length	=	19.51 in	
center of gravity of all strands and the bottom fiber of beam at the end	=	20.55 in	
Eccentricity of the strand group at transfer length:	$e_n =$	17.09 in	
Eccentricity at end of beam:	$e =$	16.05 in	

$$f_t = \frac{P_i}{A} - \frac{P_i e}{S_t} + \frac{M_D}{S_t} \qquad f_b = \frac{P_i}{A} + \frac{P_i e}{S_b} - \frac{M_D}{S_b}$$

		at midspan	at endspan	
Top stress at top fiber of beam	$f_t =$	0.342 ksi	0.342 ksi	OK
Bottom stress at bottom fiber of the beam	$f_b =$	3.021 ksi	3.021 ksi	OK

#### STRESSES AT HARP POINT

Bending moment due to beam weight at 0.3L	$M_D =$	1188.0 ft-kips		
Top stress at top fiber of beam	$f_t =$	0.035 ksi	0.035 ksi	OK
Bottom stress at bottom fiber of the beam	$f_b =$	3.300 ksi	3.300 ksi	OK

#### STRESSES AT MIDSPAN

Bending moment due to beam weight at 0.5L	$M_D =$	1414.3 ft-kips		
Top stress at top fiber of beam	$f_t =$	0.220 ksi	0.211 ksi	OK
Bottom stress at bottom fiber of the beam	$f_b =$	3.144 ksi	3.189 ksi	OK

#### HOLD-DOWN FORCES

assume stress in strand before losses =  $0.8f_u$

layer 1	=	221.4 ksi
layer 2	=	221.4 ksi
layer 3	=	221.4 ksi
layer 4	=	221.4 ksi
layer 5	=	221.4 ksi
layer 6	=	221.4 ksi
layer 7	=	221.4 ksi
layer 8	=	221.4 ksi
layer 9	=	221.4 ksi
layer 10	=	221.4 ksi
layer 11	=	221.4 ksi
layer 12	=	221.4 ksi
layer 13	=	221.4 ksi
layer 14	=	221.4 ksi

prestress force per strand before any losses:

layer 1	=	33.9 kips
layer 2	=	33.9 kips
layer 3	=	33.9 kips
layer 4	=	33.9 kips
layer 5	=	33.9 kips
layer 6	=	33.9 kips
layer 7	=	33.9 kips
layer 8	=	33.9 kips
layer 9	=	33.9 kips
layer 10	=	33.9 kips
layer 11	=	33.9 kips
layer 12	=	33.9 kips
layer 13	=	33.9 kips
layer 14	=	33.9 kips
Harp Angle	$\psi =$	7.2°

Hold-down force/strand

layer 1	=	4.4 kips/strand
layer 2	=	4.4 kips/strand
layer 3	=	4.4 kips/strand
layer 4	=	4.4 kips/strand
layer 5	=	4.4 kips/strand
layer 6	=	4.4 kips/strand
layer 7	=	4.4 kips/strand
layer 8	=	4.4 kips/strand
layer 9	=	4.4 kips/strand
layer 10	=	4.4 kips/strand
layer 11	=	4.4 kips/strand
layer 12	=	4.4 kips/strand
layer 13	=	4.4 kips/strand
layer 14	=	4.4 kips/strand
Total hold-down force	=	53.39 kips

**Stresses at Service Loads**

**STRESS LIMITS FOR CONCRETE**

**Compression:**

Due to permanent loads for load combination Service I

for the precast beam	=	3.150 ksi
for deck	=	1.463 ksi

Due to permanent and transient loads for load combination Service I

for the precast beam	=	4.200 ksi
for deck	=	1.950 ksi

**Tension:**

Load Combination Service III

for the precast beam	=	-0.016 ksi
----------------------	---	------------

**STRESSES AT MIDSPAN**

Compression stresses at top fiber of beam	at midspan	at endspan	
$f_c = \frac{P_{ps}}{A} - \frac{P_{ps}e}{S_x} + \frac{(M_y + M_s)}{S_x} + \frac{(M_{ws} + M_d)}{S_{tr}}$			
Due to permanent loads	$f_{ig} =$	2.047 ksi	2.047 ksi
$f_{tr} = \frac{P_{ps}}{A} - \frac{P_{ps}e}{S_x} + \frac{(M_y + M_s)}{S_x} + \frac{(M_{ws} + M_d)}{S_{tr}} + \frac{(M_{LL+I})}{S_{tr}}$			
Due to permanent loads and transient loads	$f_{ig} =$	2.521 ksi	2.521 ksi
<b>Compression stresses at top fiber of deck</b>	<b>at midspan</b>	<b>at endspan</b>	
$f_c = \frac{(M_{ws} + M_d)}{S_{tr}}$			
Due to permanent loads	$f_{ic} =$	0.044 ksi	0.044 ksi
$f_c = \frac{(M_{ws} + M_d + M_{LL+I})}{S_{tr}}$			
Due to permanent loads and transient loads	$f_{ic} =$	0.502 ksi	0.502 ksi
<b>Tension stresses at top fiber of deck</b>	<b>at midspan</b>	<b>at endspan</b>	
$f_{tr} = \frac{P_{ps}}{A} - \frac{P_{ps}e}{S_x} - \frac{(M_y + M_s)}{S_x} - \frac{(M_{ws} + M_d + 0.8 * M_{LL+I})}{S_{tr}}$			
Load Combination Service III	$f_b =$	-0.436 ksi	-0.436 ksi

OK

OK

OK

OK

OK

**Strength Limit State**

POSITIVE MOMENT SECTION		
$M_u = 1.25DC+1.5DW+1.75(LL+IM)$	$M_u =$	8381.5 ft-kips

effective length factor for compression members

layer 1	k =	0.28
layer 2	k =	0.28
layer 3	k =	0.28
layer 4	k =	0.28
layer 5	k =	0.28
layer 6	k =	0.28
layer 7	k =	0.28
layer 8	k =	0.28
layer 9	k =	0.28
layer 10	k =	0.28
layer 11	k =	0.28
layer 12	k =	0.28
layer 13	k =	0.28
layer 14	k =	0.28
	c =	7.0 ft-kips

average stress in prestressing steel

layer 1	$f_{ps} =$	269.6 ksi
layer 2	$f_{ps} =$	269.6 ksi
layer 3	$f_{ps} =$	269.6 ksi
layer 4	$f_{ps} =$	269.6 ksi
layer 5	$f_{ps} =$	269.6 ksi
layer 6	$f_{ps} =$	269.6 ksi
layer 7	$f_{ps} =$	269.6 ksi
layer 8	$f_{ps} =$	269.6 ksi
layer 9	$f_{ps} =$	269.6 ksi
layer 10	$f_{ps} =$	269.6 ksi
layer 11	$f_{ps} =$	269.6 ksi
layer 12	$f_{ps} =$	269.6 ksi
layer 13	$f_{ps} =$	269.6 ksi
layer 14	$f_{ps} =$	269.6 ksi

nominal flexure resistance

	a =	5.94 in
$M_r = \phi M_n, \phi = 1.00$	$\phi M_n =$	10770.5 ft-kips
M=DC+W+LL+IM	M =	5833.6 ft-kips

OK

OK

NEGATIVE MOMENT SECTION		
$M_u = 1.25DC+1.5DW+1.75(LL+IM)$	$M_u =$	-4837.2 ft-kips

	a =	5.43 in
	$\phi M_n =$	4468.5 ft-kips
M=DC+W+LL+IM	M =	-2869.7 ft-kips

NOT OK

OK



### Shear Design

CRITICAL SECTION AT 0.59		
$V_u = 1.25DC + 1.5DW + 1.75(LL + IM)$	$V_u =$	405.0 kips
$M_u = 1.25DC + 1.5DW + 1.75(LL + IM)$	$M_u =$	-2684.4 ft-kips
or		
$V_u = 1.25DC + 1.5DW + 1.75(LL + IM)$	$V_u =$	364.8 kips
$M_u = 1.25DC + 1.5DW + 1.75(LL + IM)$	$M_u =$	-2877.0 ft-kips
max shear	$V_u =$	405.0 kips
max moment	$M_u =$	2877.0 ft-kips
Shear depth	$d_v =$	73.19 in
Applied factored normal force at the section	$N_u =$	0
Angle of diagonal compressive stresses	$\theta =$	36.00 °

### STRAIN IN FLEXURAL TENSION REINFORCEMENT

$$\epsilon_x = \frac{\frac{M}{d_v} + 0.5N_u + 0.5V_u \cot \theta - A_{ps}f_{ps}}{E_s A_s + E_p A_{ps}} \leq 0.002$$

	at midspan	at endspan	
resultant compressive stress at centroid	$f_{pc} =$	1.030 ksi	1.030 ksi

effective stress in prestressing strand after all losses

layer 1	$f_{po} =$	163.0 ksi	163.0 ksi
layer 2	$f_{po} =$	163.0 ksi	163.0 ksi
layer 3	$f_{po} =$	163.0 ksi	163.0 ksi
layer 4	$f_{po} =$	163.0 ksi	163.0 ksi
layer 5	$f_{po} =$	163.0 ksi	
layer 6	$f_{po} =$	163.0 ksi	
layer 7	$f_{po} =$	163.0 ksi	
layer 8	$f_{po} =$	163.0 ksi	
layer 9	$f_{po} =$		163.0 ksi
layer 10	$f_{po} =$		163.0 ksi
layer 11	$f_{po} =$		163.0 ksi
layer 12	$f_{po} =$		163.0 ksi
layer 13	$f_{po} =$		163.0 ksi
layer 14	$f_{po} =$		163.0 ksi

strain in flexural tension

	at midspan	at endspan	
layer 1	$\epsilon_x =$	0.002000	0.002000
layer 2	$\epsilon_x =$	0.002000	0.002000
layer 3	$\epsilon_x =$	0.002000	0.002000
layer 4	$\epsilon_x =$	0.002000	0.002000
layer 5	$\epsilon_x =$	0.002000	
layer 6	$\epsilon_x =$	0.002000	
layer 7	$\epsilon_x =$	0.002000	
layer 8	$\epsilon_x =$	0.002000	
layer 9	$\epsilon_x =$		0.002000
layer 10	$\epsilon_x =$		0.002000
layer 11	$\epsilon_x =$		0.002000
layer 12	$\epsilon_x =$		0.002000
layer 13	$\epsilon_x =$		0.002000
layer 14	$\epsilon_x =$		0.002000

### Deflection and Camber

	at midspan	at endspan	
Deflection due to Prestressing Force at Transfer	$\Delta_p =$	3.97 in	3.97 in
Deflection due to Beam Self-Weight at Transfer	$\Delta_{q1} =$	-1.49 in	
Deflection due to Beam Self-Weight at Erection	$\Delta_{q2} =$	-1.44 in	
Deflection due to Haunch and Deck	$\Delta_g =$	-1.95 in	

Deflection due to total self weight

$\Delta_{sw} =$	0.59 in
-----------------	---------

Total Deflection at transfer

$\Delta =$	2.48 in	2.48 in
------------	---------	---------

Total Deflection at erection

$\Delta =$	4.49 in	4.49 in
------------	---------	---------

Live load deflection limit = span/800

$=$	1.80 in
-----	---------

Deflection due to live load and impact

$\Delta_L =$	-0.87 in
--------------	----------

OK

Deflection due to fire truck

$\Delta_L =$	-0.7819 in
--------------	------------

OK

Total Deflection after fire with fire truck

$\Delta =$	3.7734 in
------------	-----------

**Location: Fire at Critical Negative Moment Sections**  
**Beam Design: 1/2" Strand**  
**Fire Exposure Status: 3 Hour**

(PCI Bridge Design Manual Section 9.6)

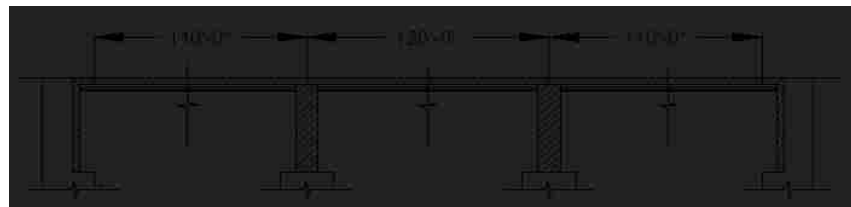


**Material Properties**

CAST-IN-PLACE SLAB		
Actual Thickness	$t_{sl} =$	8.0 in
Wearing Surface	=	0.5 in
Structural thickness = Actual - Wearing Surface	$t_s =$	7.5 in
Compressive Strength	$f'_c =$	3.02 ksi
Unit Weight	$w_c =$	150.0 pcf
Stress factor of compression block	$\beta_1 =$	0.85

BEAMS: AASHTO-PCI, BT-72 BULB-TEE		
Strength at release	$f'_{ci} =$	5.5 ksi
Strength at 28 days	$f'_c =$	7 ksi
Unit Weight	$w_c =$	150.0 pcf
Overall Beam Length:		
@ end spans	L =	110 ft
@ center span	L =	119 ft
Design Spans:		
Non-composite beam @ end spans	L =	109 ft
Non-composite beam @ center span	L =	118 ft
Composite beam @ end spans	L =	110 ft
Composite beam @ center span	L =	120 ft
Beam Spacing	S =	12 ft



**PRESTRESSING STRANDS**

Diameter of single strand	d =	0.5 in
Area of single strand	A =	0.153 in <sup>2</sup>

Temperature of Layer

layer 1 (bottom)	T =	68.00 °F
layer 2	T =	68.00 °F
layer 3	T =	68.00 °F
layer 4	T =	68.00 °F
layer 5	T =	68.00 °F
layer 6	T =	68.00 °F
layer 7	T =	68.00 °F
layer 8	T =	68.00 °F
layer 9	T =	68.00 °F
layer 10	T =	68.00 °F
layer 11	T =	68.00 °F
layer 12	T =	68.00 °F
layer 13	T =	68.00 °F
layer 14	T =	68.00 °F

Ultimate Strength

initial = 277 ksi

layer 1 (bottom)	f <sub>pu</sub> =	277 ksi
layer 2	f <sub>pu</sub> =	277 ksi
layer 3	f <sub>pu</sub> =	277 ksi
layer 4	f <sub>pu</sub> =	277 ksi
layer 5	f <sub>pu</sub> =	277 ksi
layer 6	f <sub>pu</sub> =	277 ksi
layer 7	f <sub>pu</sub> =	277 ksi
layer 8	f <sub>pu</sub> =	277 ksi
layer 9	f <sub>pu</sub> =	277 ksi
layer 10	f <sub>pu</sub> =	277 ksi
layer 11	f <sub>pu</sub> =	277 ksi
layer 12	f <sub>pu</sub> =	277 ksi
layer 13	f <sub>pu</sub> =	277 ksi
layer 14	f <sub>pu</sub> =	277 ksi

Yield Strength

initial = 250 ksi

layer 1 (bottom)	f <sub>py</sub> =	250 ksi
layer 2	f <sub>py</sub> =	250 ksi
layer 3	f <sub>py</sub> =	250 ksi
layer 4	f <sub>py</sub> =	250 ksi
layer 5	f <sub>py</sub> =	250 ksi
layer 6	f <sub>py</sub> =	250 ksi
layer 7	f <sub>py</sub> =	250 ksi
layer 8	f <sub>py</sub> =	250 ksi
layer 9	f <sub>py</sub> =	250 ksi
layer 10	f <sub>py</sub> =	250 ksi
layer 11	f <sub>py</sub> =	250 ksi
layer 12	f <sub>py</sub> =	250 ksi
layer 13	f <sub>py</sub> =	250 ksi
layer 14	f <sub>py</sub> =	250 ksi

Stress Limits:

before transfer ≤ 0.75f<sub>pu</sub> (initial = 207.6)

layer 1 (bottom)	f <sub>pi</sub> =	207.6 ksi
layer 2	f <sub>pi</sub> =	207.6 ksi
layer 3	f <sub>pi</sub> =	207.6 ksi
layer 4	f <sub>pi</sub> =	207.6 ksi
layer 5	f <sub>pi</sub> =	207.6 ksi
layer 6	f <sub>pi</sub> =	207.6 ksi
layer 7	f <sub>pi</sub> =	207.6 ksi
layer 8	f <sub>pi</sub> =	207.6 ksi
layer 9	f <sub>pi</sub> =	207.6 ksi
layer 10	f <sub>pi</sub> =	207.6 ksi
layer 11	f <sub>pi</sub> =	207.6 ksi
layer 12	f <sub>pi</sub> =	207.6 ksi
layer 13	f <sub>pi</sub> =	207.6 ksi
layer 14	f <sub>pi</sub> =	207.6 ksi

at service limit state (after all losses)  $\leq 0.80f_{py}$  (initial = 199.7)

layer 1 (bottom)	$f_{pe} =$	199.7 ksi
layer 2	$f_{pe} =$	199.7 ksi
layer 3	$f_{pe} =$	199.7 ksi
layer 4	$f_{pe} =$	199.7 ksi
layer 5	$f_{pe} =$	199.7 ksi
layer 6	$f_{pe} =$	199.7 ksi
layer 7	$f_{pe} =$	199.7 ksi
layer 8	$f_{pe} =$	199.7 ksi
layer 9	$f_{pe} =$	199.7 ksi
layer 10	$f_{pe} =$	199.7 ksi
layer 11	$f_{pe} =$	199.7 ksi
layer 12	$f_{pe} =$	199.7 ksi
layer 13	$f_{pe} =$	199.7 ksi
layer 14	$f_{pe} =$	199.7 ksi

Modulus of Elasticity

initial = 25982 ksi

layer 1 (bottom)	E =	25982.0 ksi
layer 2	E =	25982.0 ksi
layer 3	E =	25982.0 ksi
layer 4	E =	25982.0 ksi
layer 5	E =	25982.0 ksi
layer 6	E =	25982.0 ksi
layer 7	E =	25982.0 ksi
layer 8	E =	25982.0 ksi
layer 9	E =	25982.0 ksi
layer 10	E =	25982.0 ksi
layer 11	E =	25982.0 ksi
layer 12	E =	25982.0 ksi
layer 13	E =	25982.0 ksi
layer 14	E =	25982.0 ksi

### MILD STEEL REINFORCING BARS

Yield Strength

Layer 1 (Bottom)	$f_y =$	60.0 ksi	68.00 °F
Layer 2 (Top)	$f_y =$	48.0 ksi	1300.00 °F

Modulus of Elasticity

E =	29000.0 ksi
-----	-------------

Layer 1 (Bottom)

Area of steel at midspan (effective flange)	$A_{sm} =$	2.79 in <sup>2</sup>
Area of steel at endspan (effective flange)	$A_{se} =$	2.48 in <sup>2</sup>
Area of temperature and shrinkage steel (12" width)	$A_s =$	0.31 in <sup>2</sup>

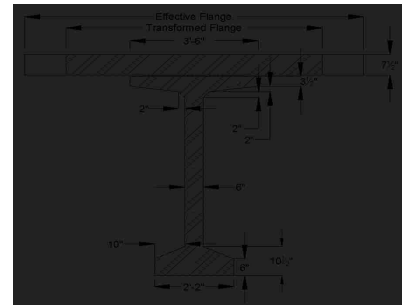
Layer 2 (Top)

Area of steel at midspan (effective flange)	$A_{sm} =$	12.6 in <sup>2</sup>
Area of steel at endspan (effective flange)	$A_{se} =$	12.4 in <sup>2</sup>
Area of temperature and shrinkage steel (12" width)	$A_s =$	0.2 in <sup>2</sup>

### Cross-sectional Properties

#### NON-COMPOSITE BEAM

Area of cross-section of beam	A =	767.0 in <sup>2</sup>
Overall depth of beam	H =	72.0 in
Moment of Inertia	I =	539,947 in <sup>4</sup>
Distance from centroid to extreme bottom fiber	$y_b =$	36.6 in
Distance from centroid to extreme top fiber	$y_t =$	35.4 in
Section modulus for the extreme bottom fiber	$S_b =$	14915.0 in <sup>3</sup>
Section modulus for the extreme top fiber	$S_t =$	15421.0 in <sup>3</sup>
Weight	$W_1 =$	799.0 plf
Modulus of Elasticity = $33000 \cdot (W_c^{1.5}) \cdot (\sqrt{f_c})$		
cast-in-place concrete deck	$E_{cp} =$	3332 ksi
precast beam at release	$E_{ci} =$	4496 ksi
precast beam at service loads	$E_c =$	5072 ksi



### COMPOSITE BEAM AT MIDSPAN

Effective Flange Width	$b_f =$	111.0 in	*min of three criteria
Modular Ratio = $E_{cs}/E_c$	$n =$	0.6568	
Transformed flange width	$=$	72.9 in	
Transformed flange area	$=$	546.8 in <sup>2</sup>	
Transformed haunch width	$=$	27.6 in	
Transformed haunch area	$=$	13.8 in <sup>2</sup>	
Deck-distance to top fiber	$y_t =$	5.62 in	

	Transformed Area	$y_b$	$Ay_b$	$A(y_{bc}-y_b)^2$	I	$I + A(y_{bc}-y_b)^2$
Beam	767.0 in <sup>2</sup>	36.60 in	28,072.2 in <sup>3</sup>	194,666 in <sup>4</sup>	539,947 in <sup>4</sup>	734,613 in <sup>4</sup>
Haunch	13.8 in <sup>2</sup>	72.25 in	996.6 in <sup>3</sup>	5,363 in <sup>4</sup>	0.33 in <sup>4</sup>	5,364 in <sup>4</sup>
Deck	546.8 in <sup>2</sup>	74.38 in	40,671.9 in <sup>3</sup>	261,033 in <sup>4</sup>	873 in <sup>4</sup>	261,905 in <sup>4</sup>
Total	1327.6 in <sup>2</sup>		69,740.7 in <sup>3</sup>			1,001,883 in <sup>4</sup>

Total area of Composite Section	$A_c =$	1328 in <sup>2</sup>
Overall Depth of the Composite Section	$h_c =$	80 in
Moment of Inertia	$I_c =$	1,001,883 in <sup>4</sup>
Distance from centroid to extreme <u>bottom</u> fiber of beam	$y_{bc} =$	52.53 in
Distance from centroid to extreme <u>top</u> fiber of beam	$y_{tc} =$	19.47 in
Distance from centroid to extreme <u>top</u> fiber of slab	$y_{ts} =$	27.47 in
Section modulus for the extreme <u>bottom</u> fiber of beam	$S_{bc} =$	19,072.2 in <sup>3</sup>
Section modulus for the extreme <u>top</u> fiber of beam	$S_{tc} =$	51,460.9 in <sup>3</sup>
Section modulus for the extreme <u>top</u> fiber slab	$S_{ts} =$	55,529.3 in <sup>3</sup>

### COMPOSITE BEAM AT ENDSPAN

Effective Flange Width	$b_f =$	106.6 in	*min of three criteria
Modular Ratio = $E_{cs}/E_c$	$n =$	0.6568	
Transformed flange width	$=$	70.0 in	
Transformed flange area	$=$	525.1 in <sup>2</sup>	
Transformed haunch width	$=$	27.6 in	
Transformed haunch area	$=$	13.8 in <sup>2</sup>	
Deck-distance to top fiber	$y_{td} =$	5.62 in	

	Transformed Area	$y_t$	$Ay_t$	$A(y_{tc}-y_t)^2$	I	$I + A(y_{tc}-y_t)^2$
Beam	767.0 in <sup>2</sup>	36.60 in	28,072.2 in <sup>3</sup>	256,088 in <sup>4</sup>	539,947 in <sup>4</sup>	796,035 in <sup>4</sup>
Haunch	13.8 in <sup>2</sup>	72.25 in	996.6 in <sup>3</sup>	4,605 in <sup>4</sup>	0.29 in <sup>4</sup>	4,606 in <sup>4</sup>
Deck	525.1 in <sup>2</sup>	78.12 in	41,023.7 in <sup>3</sup>	175,334 in <sup>4</sup>	840 in <sup>4</sup>	176,174 in <sup>4</sup>
Total	1305.9 in <sup>2</sup>		70,092.5 in <sup>3</sup>			976,815 in <sup>4</sup>

Total area of Composite Section	$A_c =$	1306 in <sup>2</sup>
Overall Depth of the Composite Section	$h_c =$	80 in
Moment of Inertia	$I_c =$	976,815 in <sup>4</sup>
Distance from centroid to extreme <u>bottom</u> fiber of beam	$y_{bc} =$	53.67 in
Distance from centroid to extreme <u>top</u> fiber of beam	$y_{tc} =$	18.33 in
Distance from centroid to extreme <u>top</u> fiber of slab	$y_{ts} =$	26.33 in
Section modulus for the extreme <u>bottom</u> fiber of beam	$S_{bc} =$	18,199.6 in <sup>3</sup>
Section modulus for the extreme <u>top</u> fiber of beam	$S_{tc} =$	53,297.6 in <sup>3</sup>
Section modulus for the extreme <u>top</u> fiber slab	$S_{ts} =$	37,102.4 in <sup>3</sup>

### Shear Forces and Bending Moments

#### DEAD LOADS

Beam self-weight	$W_{beam} =$	0.799 k/f
8 in. deck weight	$W_{deck} =$	1.200 k/f
1/2 in. haunch weight	$W_{haunch} =$	0.022 k/f

#### LRFD Specifications: Art. 4.6.2.2.1

Width of Deck Constant		OK
Number of beams is not less than four $N_b =$	4	OK
Roadway part of the overhang, $d_o \leq 3.0$ ft, $d_o =$	1.5	OK
Curvature in plans is less than $4^\circ =$	0	OK
Cross-section of the bridge is consistent with one of the cross sections given by LRFD specs		OK

Barrier and wearing surface loads are equally distributed among the 4 beams

Barrier Wt	$W_t =$	0.150 k/f
Dead load of future wearing surface	$DW =$	0.263 k/f

LIVE LOADS		
Fire truck live load front load (Point A)	$P_{live} =$	48.0 kips
Fire truck live load back load (Point B)	$P_{live} =$	22.0 kips
distance between two loads		19.2 ft
distance from nearest edge to point A	$x_a =$	59.0 ft
distance from nearest edge to point B	$x_b =$	39.8 ft
LRFD Specifications: Art. 4.6.2.2.1		
Width of Deck Constant		OK
Number of beams is not less than four $N_b =$	4	OK
Beams are parallel and approximately of the same stiffness		OK
Roadway part of the overhang, $d_o \leq 3.0$ ft, $d_o =$	1.5	OK
Curvature in plans is less than $4^\circ =$	0	OK

Barrier and wearing surface loads are equally distributed among the 4 beams

Bridge Type-- "k" (LRFD Table 4.6.2.2.1-1)

Number of design lanes = w/12	=	3 lanes
-------------------------------	---	---------

**Distribution Factor for Bending Moment:**

Beams spacing	S =	12.0 ft
Depth of concrete slab	$t_s =$	7.5 in
Beam Span	L =	120.0 ft
Number of Beams	$N_b =$	4
Modular ratio between beam & deck materials	n =	1.5225
Longitudinal stiffness parameter	$K_B =$	2,657,855.22 in <sup>4</sup>

at center span:

$$DFM = 0.75 + \left(\frac{S}{9.5}\right)^{0.6} * \left(\frac{S}{L}\right)^{0.2} * \left(\frac{K_B}{12 * L * t_s^3}\right)^{0.1}$$

DFM =	0.916 lanes/beam
-------	------------------

0.905 Controls

one design lane loaded:

$$DFM = 0.75 + \left(\frac{S}{14}\right)^{0.4} * \left(\frac{S}{L}\right)^{0.2} * \left(\frac{K_B}{12 * L * t_s^3}\right)^{0.1}$$

DFM =	0.621 lanes/beam
-------	------------------

**Distribution Factor for Shear Force**

both end spans and center span:

$$DFV = 0.2 + \left(\frac{S}{12}\right) - \left(\frac{S}{35}\right)^2$$

DFV =	1.082 lanes/beam
-------	------------------

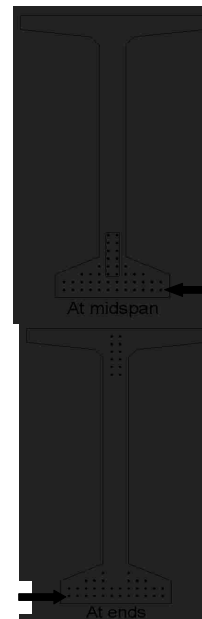
1.082 Controls

one design lane loaded:

$$DFV = 0.36 + \left(\frac{S}{25}\right)$$

DFV =	0.840 lanes/beam
-------	------------------

	At Midspan		At Ends	
from bottom	No. of	Distance from Bottom	No. of	Distance from Bottom
layer 1	12	2	12	2
layer 2	12	4	12	4
layer 3	8	6	6	6
layer 4	4	8	2	8
layer 5	2	10	-	-
layer 6	2	12	-	-
layer 7	2	14	-	-
layer 8	2	16	-	-
layer 9	-	-	2	60
layer 10	-	-	2	62
layer 11	-	-	2	64
layer 12	-	-	2	66
layer 13	-	-	2	68
layer 14	-	-	2	70
<b>Harped Strand Group (included in above totals)</b>				
layer 3	2	6		
layer 4	2	8		
layer 5	2	10		
layer 6	2	12		
layer 7	2	14		
layer 8	2	16		



distance from the center of gravity of strands to the bottom fiber of the beam = 7% of the beam depth

strand eccentricity at midspan =  $(y_c - y_{bs})$

$y_{bs} =$	5.82 in	layer 1
$e_c =$	30.78 in	

**Prestress Losses**

**ELASTIC SHORTENING**

assumed loss	=	9.00%
Force per strand at transfer		
layer 1	=	28.9 kips
layer 2	=	28.9 kips
layer 3	=	28.9 kips
layer 4	=	28.9 kips
layer 5	=	28.9 kips
layer 6	=	28.9 kips
layer 7	=	28.9 kips
layer 8	=	28.9 kips
layer 9	=	28.9 kips
layer 10	=	28.9 kips
layer 11	=	28.9 kips
layer 12	=	28.9 kips
layer 13	=	28.9 kips
layer 14	=	28.9 kips

Total prestressing force at release	$P_i =$	at midspan 1271.6 kips	at endspan 1271.6 kips
Sum of concrete stresses at the center of gravity of prestressing tendons due to prestressing force at transfer and the self-weight of the member at sections of maximum moment	$f_{cgp} =$	2.938 ksi	2.938 ksi
Loss due to shortening		at midspan	at endspan
layer 1	$\Delta f_{PES} =$	17.0 ksi	17.0 ksi
layer 2	$\Delta f_{PES} =$	17.0 ksi	17.0 ksi
layer 3	$\Delta f_{PES} =$	17.0 ksi	17.0 ksi
layer 4	$\Delta f_{PES} =$	17.0 ksi	17.0 ksi
layer 5	$\Delta f_{PES} =$	17.0 ksi	
layer 6	$\Delta f_{PES} =$	17.0 ksi	
layer 7	$\Delta f_{PES} =$	17.0 ksi	
layer 8	$\Delta f_{PES} =$	17.0 ksi	
layer 9	$\Delta f_{PES} =$		17.0 ksi
layer 10	$\Delta f_{PES} =$		17.0 ksi
layer 11	$\Delta f_{PES} =$		17.0 ksi
layer 12	$\Delta f_{PES} =$		17.0 ksi
layer 13	$\Delta f_{PES} =$		17.0 ksi
layer 14	$\Delta f_{PES} =$		17.0 ksi

**SHRINKAGE**

Shrinkage = (17-0.15*Relative Humidity)	$\Delta f_{PSR} =$	6.5 ksi	← assume relative humidity = 70%
---	--------------------	---------	----------------------------------

**CREEP OF CONCRETE**

Change of stresses at center of gravity of prestressing due to permanent loads except the loads acting at time of applying prestressing force, calculated at the same section as $f_{cgp}$	$\Delta f_{cdp} =$	1.567 ksi	
loss due to creep	$\Delta f_{PCR} =$	at midspan 24.3 ksi	at endspan 24.3 ksi

**RELAXATION OF PRESTRESSING STRANDS**

loss due to relaxation after transfer		at midspan	at endspan
layer 1	$\Delta f_{PR2} =$	2.1 ksi	2.1 ksi
layer 2	$\Delta f_{PR2} =$	2.1 ksi	2.1 ksi
layer 3	$\Delta f_{PR2} =$	2.1 ksi	2.1 ksi
layer 4	$\Delta f_{PR2} =$	2.1 ksi	2.1 ksi
layer 5	$\Delta f_{PR2} =$	2.1 ksi	
layer 6	$\Delta f_{PR2} =$	2.1 ksi	
layer 7	$\Delta f_{PR2} =$	2.1 ksi	
layer 8	$\Delta f_{PR2} =$	2.1 ksi	
layer 9	$\Delta f_{PR2} =$		2.1 ksi
layer 10	$\Delta f_{PR2} =$		2.1 ksi
layer 11	$\Delta f_{PR2} =$		2.1 ksi
layer 12	$\Delta f_{PR2} =$		2.1 ksi
layer 13	$\Delta f_{PR2} =$		2.1 ksi
layer 14	$\Delta f_{PR2} =$		2.1 ksi

**TOTAL LOSSES AT TRANSFER**

total loss  $\Delta f_{pES} = \Delta f_{pi}$

stress in tendons after transfer  $f_{pi} = f_{pr} - \Delta f_{pi}$

		at midspan	at endspan
layer 1	$f_{pi} =$	190.6 ksi	190.6 ksi
layer 2	$f_{pi} =$	190.6 ksi	190.6 ksi
layer 3	$f_{pi} =$	190.6 ksi	190.6 ksi
layer 4	$f_{pi} =$	190.6 ksi	190.6 ksi
layer 5	$f_{pi} =$	190.6 ksi	
layer 6	$f_{pi} =$	190.6 ksi	
layer 7	$f_{pi} =$	190.6 ksi	
layer 8	$f_{pi} =$	190.6 ksi	
layer 9	$f_{pi} =$		190.6 ksi
layer 10	$f_{pi} =$		190.6 ksi
layer 11	$f_{pi} =$		190.6 ksi
layer 12	$f_{pi} =$		190.6 ksi
layer 13	$f_{pi} =$		190.6 ksi
layer 14	$f_{pi} =$		190.6 ksi

force per strand =  $f_{pi} \times \text{strand area}$

		at midspan	at endspan
layer 1	=	29.2 kips	29.2 kips
layer 2	=	29.2 kips	29.2 kips
layer 3	=	29.2 kips	29.2 kips
layer 4	=	29.2 kips	29.2 kips
layer 5	=	29.2 kips	
layer 6	=	29.2 kips	
layer 7	=	29.2 kips	
layer 8	=	29.2 kips	
layer 9	=		29.2 kips
layer 10	=		29.2 kips
layer 11	=		29.2 kips
layer 12	=		29.2 kips
layer 13	=		29.2 kips
layer 14	=		29.2 kips
Total prestressing force after transfer	$P_i =$	1284.8 kips	1284.8 kips

Initial loss =  $(\Delta f_{pi}) / (f_{pi})$

		at midspan	at endspan
layer 1	% =	8.2%	8.2%
layer 2	% =	8.2%	8.2%
layer 3	% =	8.2%	8.2%
layer 4	% =	8.2%	8.2%
layer 5	% =	8.2%	
layer 6	% =	8.2%	
layer 7	% =	8.2%	
layer 8	% =	8.2%	
layer 9	% =		8.2%
layer 10	% =		8.2%
layer 11	% =		8.2%
layer 12	% =		8.2%
layer 13	% =		8.2%
layer 14	% =		8.2%

OK  
OK  
OK  
OK  
OK  
OK  
OK  
OK  
OK  
OK  
OK  
OK  
OK  
OK

**TOTAL LOSSES AT SERVICE LOADS**

Total Losses

		at midspan	at endspan
layer 1	$\Delta f_{pT} =$	49.9 ksi	49.9 ksi
layer 2	$\Delta f_{pT} =$	49.9 ksi	49.9 ksi
layer 3	$\Delta f_{pT} =$	49.9 ksi	49.9 ksi
layer 4	$\Delta f_{pT} =$	49.9 ksi	49.9 ksi
layer 5	$\Delta f_{pT} =$	49.9 ksi	
layer 6	$\Delta f_{pT} =$	49.9 ksi	
layer 7	$\Delta f_{pT} =$	49.9 ksi	
layer 8	$\Delta f_{pT} =$	49.9 ksi	
layer 9	$\Delta f_{pT} =$		49.9 ksi
layer 10	$\Delta f_{pT} =$		49.9 ksi
layer 11	$\Delta f_{pT} =$		49.9 ksi
layer 12	$\Delta f_{pT} =$		49.9 ksi
layer 13	$\Delta f_{pT} =$		49.9 ksi
layer 14	$\Delta f_{pT} =$		49.9 ksi



Stress in tendon after all losses =  $f_{pe} - \Delta f_{pt}$

		at midspan	at endspan
layer 1	$f_{pe} =$	157.7 ksi	157.7 ksi
layer 2	$f_{pe} =$	157.7 ksi	157.7 ksi
layer 3	$f_{pe} =$	157.7 ksi	157.7 ksi
layer 4	$f_{pe} =$	157.7 ksi	157.7 ksi
layer 5	$f_{pe} =$	157.7 ksi	
layer 6	$f_{pe} =$	157.7 ksi	
layer 7	$f_{pe} =$	157.7 ksi	
layer 8	$f_{pe} =$	157.7 ksi	
layer 9	$f_{pe} =$		157.7 ksi
layer 10	$f_{pe} =$		157.7 ksi
layer 11	$f_{pe} =$		157.7 ksi
layer 12	$f_{pe} =$		157.7 ksi
layer 13	$f_{pe} =$		157.7 ksi
layer 14	$f_{pe} =$		157.7 ksi

check prestressing stress limit at service limit state:  $f_{pe} \leq 0.8 \cdot f_{py}$

layer 1	=	199.7 ksi
layer 2	=	199.7 ksi
layer 3	=	199.7 ksi
layer 4	=	199.7 ksi
layer 5	=	199.7 ksi
layer 6	=	199.7 ksi
layer 7	=	199.7 ksi
layer 8	=	199.7 ksi
layer 9	=	199.7 ksi
layer 10	=	199.7 ksi
layer 11	=	199.7 ksi
layer 12	=	199.7 ksi
layer 13	=	199.7 ksi
layer 14	=	199.7 ksi

OK  
OK  
OK  
OK  
OK  
OK  
OK  
OK  
OK  
OK  
OK  
OK  
OK  
OK

force per strand =  $f_{pe} \cdot \text{strand area}$

		at midspan	at endspan
layer 1	=	24.1 kips	24.1 kips
layer 2	=	24.1 kips	24.1 kips
layer 3	=	24.1 kips	24.1 kips
layer 4	=	24.1 kips	24.1 kips
layer 5	=	24.1 kips	
layer 6	=	24.1 kips	
layer 7	=	24.1 kips	
layer 8	=	24.1 kips	
layer 9	=		24.1 kips
layer 10	=		24.1 kips
layer 11	=		24.1 kips
layer 12	=		24.1 kips
layer 13	=		24.1 kips
layer 14	=		24.1 kips

Total prestressing force after all losses

		at midspan	at endspan
$P_{pe} =$		1061.8 kips	1061.8 kips

Final losses, % =  $(\Delta f_{pt}) / (f_{pi})$

layer 1	% =	24.0%	24.0%
layer 2	% =	24.0%	24.0%
layer 3	% =	24.0%	24.0%
layer 4	% =	24.0%	24.0%
layer 5	% =	24.0%	
layer 6	% =	24.0%	
layer 7	% =	24.0%	
layer 8	% =	24.0%	
layer 9	% =		24.0%
layer 10	% =		24.0%
layer 11	% =		24.0%
layer 12	% =		24.0%
layer 13	% =		24.0%
layer 14	% =		24.0%
Average final losses, %	% =	24.0%	24.0%

## Stresses at Transfer

### STRESS LIMITS FOR CONCRETE

Compression = $0.6f_{ci}$	$f_{ci} =$	3.300 ksi
Tension		
without bonded reinforcement = $-0.0948\sqrt{f_{ci}} \leq -0.2$	=	-0.200 ksi
with bonded auxiliary reinforcement = $-0.22\sqrt{f_{ci}}$	=	-0.016 ksi

### STRESSES AT TRANSFER LENGTH SECTION

Transfer Length = $60 \times (\text{strand diameter})$	=	2.5 ft	} Calcs for eccentricity (see 9.6.7.2)
Bending moment at transfer length	$M_g =$	116.4 ft-kips	
center of 12 strands to top fiber of beam at the end	=	7.00 in	
center of 12 strands to bottom fiber of beam at the harp point	=	11.00 in	
center of 12 strands and top fiber of beam at transfer length	=	10.78 in	
center of gravity of 32 strands and bottom fiber of beam	=	3.88 in	
center of gravity of all strands and the bottom fiber of beam at transfer length	=	19.51 in	
center of gravity of all strands and the bottom fiber of beam at the end	=	20.55 in	
Eccentricity of the strand group at transfer length:	$e_n =$	17.09 in	
Eccentricity at end of beam:	$e =$	16.05 in	

$$f_t = \frac{P_i}{A} - \frac{P_i e}{S_t} + \frac{M_g}{S_t}$$

$$f_b = \frac{P_i}{A} + \frac{P_i e}{S_b} - \frac{M_g}{S_b}$$

		at midspan	at endspan	
Top stress at top fiber of beam	$f_t =$	0.342 ksi	0.342 ksi	OK
Bottom stress at bottom fiber of the beam	$f_b =$	3.021 ksi	3.021 ksi	OK

### STRESSES AT HARP POINT

Bending moment due to beam weight at 0.3L	$M_g =$	1188.0 ft-kips		
Top stress at top fiber of beam	$f_t =$	0.035 ksi	0.035 ksi	OK
Bottom stress at bottom fiber of the beam	$f_b =$	3.300 ksi	3.300 ksi	OK

### STRESSES AT MIDSPAN

Bending moment due to beam weight at 0.5L	$M_g =$	1414.3 ft-kips		
Top stress at top fiber of beam	$f_t =$	0.220 ksi	0.211 ksi	OK
Bottom stress at bottom fiber of the beam	$f_b =$	3.144 ksi	3.189 ksi	OK

### HOLD-DOWN FORCES

assume stress in strand before losses =  $0.8f_u$

layer 1	=	221.4 ksi
layer 2	=	221.4 ksi
layer 3	=	221.4 ksi
layer 4	=	221.4 ksi
layer 5	=	221.4 ksi
layer 6	=	221.4 ksi
layer 7	=	221.4 ksi
layer 8	=	221.4 ksi
layer 9	=	221.4 ksi
layer 10	=	221.4 ksi
layer 11	=	221.4 ksi
layer 12	=	221.4 ksi
layer 13	=	221.4 ksi
layer 14	=	221.4 ksi

prestress force per strand before any losses:

layer 1	=	33.9 kips
layer 2	=	33.9 kips
layer 3	=	33.9 kips
layer 4	=	33.9 kips
layer 5	=	33.9 kips
layer 6	=	33.9 kips
layer 7	=	33.9 kips
layer 8	=	33.9 kips
layer 9	=	33.9 kips
layer 10	=	33.9 kips
layer 11	=	33.9 kips
layer 12	=	33.9 kips
layer 13	=	33.9 kips
layer 14	=	33.9 kips
Harp Angle	$\psi =$	7.2 °

Hold-down force/strand

layer 1	=	4.4 kips/strand
layer 2	=	4.4 kips/strand
layer 3	=	4.4 kips/strand
layer 4	=	4.4 kips/strand
layer 5	=	4.4 kips/strand
layer 6	=	4.4 kips/strand
layer 7	=	4.4 kips/strand
layer 8	=	4.4 kips/strand
layer 9	=	4.4 kips/strand
layer 10	=	4.4 kips/strand
layer 11	=	4.4 kips/strand
layer 12	=	4.4 kips/strand
layer 13	=	4.4 kips/strand
layer 14	=	4.4 kips/strand
Total hold-down force	=	53.39 kips

**Stresses at Service Loads**

**STRESS LIMITS FOR CONCRETE**

**Compression:**

Due to permanent loads for load combination Service I

for the precast beam	=	3.150 ksi
for deck	=	1.359 ksi

Due to permanent and transient loads for load combination Service I

for the precast beam	=	4.200 ksi
for deck	=	1.812 ksi

**Tension:**

Load Combination Service III

for the precast beam	=	-0.016 ksi
----------------------	---	------------

**STRESSES AT MIDSPAN**

Compression stresses at top fiber of beam	at midspan	at endspan	
$f_t = \frac{P_{ps}}{A} - \frac{P_{ps}e}{S_t} + \frac{(M_D + M_L)}{S_t} + \frac{(M_{ws} + M_s)}{S_{tr}}$			
Due to permanent loads	$f_{t0} =$	2.049 ksi	2.049 ksi
$f_{tr} = \frac{P_{ps}}{A} - \frac{P_{ps}e}{S_t} + \frac{(M_D + M_L)}{S_t} + \frac{(M_{ws} + M_s)}{S_{tr}} + \frac{(M_{LL+1})}{S_{tr}}$			
Due to permanent loads and transient loads	$f_{t0} =$	2.542 ksi	2.542 ksi
<b>Compression stresses at top fiber of deck</b>	<b>at midspan</b>	<b>at endspan</b>	
$f_{tc} = \frac{(M_{ws} + M_s)}{S_{tr}}$			
Due to permanent loads	$f_{tc} =$	0.043 ksi	0.043 ksi
$f_{tc} = \frac{(M_{ws} + M_s + M_{LL+1})}{S_{tr}}$			
Due to permanent loads and transient loads	$f_{tc} =$	0.500 ksi	0.500 ksi
<b>Tension stresses at top fiber of deck</b>	<b>at midspan</b>	<b>at endspan</b>	
$f_{tr} = \frac{P_{ps}}{A} - \frac{P_{ps}e}{S_t} - \frac{(M_D + M_L)}{S_t} - \frac{(M_{ws} + M_s + C.8 * M_{LL+1})}{S_{tr}}$			
Load Combination Service III	$f_{tr} =$	-0.445 ksi	-0.445 ksi

OK

OK

OK

OK

OK

**Strength Limit State**

**POSITIVE MOMENT SECTION**

$M_u = 1.25DC+1.5DW+1.75(LL+IM)$	$M_u =$	8381.5 ft-kips
----------------------------------	---------	----------------

effective length factor for compression members

layer 1	k =	0.28
layer 2	k =	0.28
layer 3	k =	0.28
layer 4	k =	0.28
layer 5	k =	0.28
layer 6	k =	0.28
layer 7	k =	0.28
layer 8	k =	0.28
layer 9	k =	0.28
layer 10	k =	0.28
layer 11	k =	0.28
layer 12	k =	0.28
layer 13	k =	0.28
layer 14	k =	0.28
	c =	7.5 ft-kips

average stress in prestressing steel

layer 1	$f_{ps} =$	269.1 ksi
layer 2	$f_{ps} =$	269.1 ksi
layer 3	$f_{ps} =$	269.1 ksi
layer 4	$f_{ps} =$	269.1 ksi
layer 5	$f_{ps} =$	269.1 ksi
layer 6	$f_{ps} =$	269.1 ksi
layer 7	$f_{ps} =$	269.1 ksi
layer 8	$f_{ps} =$	269.1 ksi
layer 9	$f_{ps} =$	269.1 ksi
layer 10	$f_{ps} =$	269.1 ksi
layer 11	$f_{ps} =$	269.1 ksi
layer 12	$f_{ps} =$	269.1 ksi
layer 13	$f_{ps} =$	269.1 ksi
layer 14	$f_{ps} =$	269.1 ksi

nominal flexure resistance

	a =	6.38 in
$M_r = \phi M_n, \phi = 1.00$	$\phi M_n =$	10716.1 ft-kips
M=DC+W+LL+IM	M =	5833.6 ft-kips

OK  
OK

**NEGATIVE MOMENT SECTION**

$M_u = 1.25DC+1.5DW+1.75(LL+IM)$	$M_u =$	-4837.2 ft-kips
----------------------------------	---------	-----------------

	a =	4.99 in
	$\phi M_n =$	4115.5 ft-kips
M=DC+W+LL+IM	M =	-2869.7 ft-kips

NOT OK  
OK

## Shear Design

CRITICAL SECTION AT 0.59		
$V_u = 1.25DC + 1.5DW + 1.75(LL + IM)$	$V_u =$	405.0 kips
$M_u = 1.25DC + 1.5DW + 1.75(LL + IM)$	$M_u =$	-2684.4 ft-kips
or		
$V_u = 1.25DC + 1.5DW + 1.75(LL + IM)$	$V_u =$	364.8 kips
$M_u = 1.25DC + 1.5DW + 1.75(LL + IM)$	$M_u =$	-2877.0 ft-kips
max shear	$V_u =$	405.0 kips
max moment	$M_u =$	2877.0 ft-kips
Shear depth	$d_v =$	73.19 in
Applied factored normal force at the section	$N_u =$	0
Angle of diagonal compressive stresses	$\theta =$	36.00 °

### STRAIN IN FLEXURAL TENSION REINFORCEMENT

$$\epsilon_x = \frac{\frac{M_u}{d_v} + 0.5N_u + 0.5V_u \cot \theta - A_{ps}f_{ps}}{E_s A_s + E_p A_{ps}} \leq 0.002$$

	at midspan	at endspan	
resultant compressive stress at centroid	$f_{pc} =$	1.040 ksi	1.040 ksi

effective stress in prestressing strand after all losses

	at midspan	at endspan
layer 1	$f_{ps} =$	163.1 ksi
layer 2	$f_{ps} =$	163.1 ksi
layer 3	$f_{ps} =$	163.1 ksi
layer 4	$f_{ps} =$	163.1 ksi
layer 5	$f_{ps} =$	
layer 6	$f_{ps} =$	
layer 7	$f_{ps} =$	
layer 8	$f_{ps} =$	
layer 9	$f_{ps} =$	163.1 ksi
layer 10	$f_{ps} =$	163.1 ksi
layer 11	$f_{ps} =$	163.1 ksi
layer 12	$f_{ps} =$	163.1 ksi
layer 13	$f_{ps} =$	163.1 ksi
layer 14	$f_{ps} =$	163.1 ksi

strain in flexural tension

	at midspan	at endspan
layer 1	$\epsilon_x =$	0.002000
layer 2	$\epsilon_x =$	0.002000
layer 3	$\epsilon_x =$	0.002000
layer 4	$\epsilon_x =$	0.002000
layer 5	$\epsilon_x =$	
layer 6	$\epsilon_x =$	
layer 7	$\epsilon_x =$	
layer 8	$\epsilon_x =$	
layer 9	$\epsilon_x =$	0.002000
layer 10	$\epsilon_x =$	0.002000
layer 11	$\epsilon_x =$	0.002000
layer 12	$\epsilon_x =$	0.002000
layer 13	$\epsilon_x =$	0.002000
layer 14	$\epsilon_x =$	0.002000

## Deflection and Camber

	at midspan	at endspan
Deflection due to Prestressing Force at Transfer	$\Delta_p =$	3.97 in
Deflection due to Beam Self-Weight at Transfer	$\Delta_{q1} =$	-1.49 in
Deflection due to Beam Self-Weight at Erection	$\Delta_{q2} =$	-1.44 in
Deflection due to Haunch and Deck	$\Delta_g =$	-1.95 in

Deflection due to total self weight

$\Delta_{sw} =$	0.59 in
-----------------	---------

Total Deflection at transfer

$\Delta =$	2.48 in	2.48 in
------------	---------	---------

Total Deflection at erection

$\Delta =$	4.49 in	4.49 in
------------	---------	---------

Live load deflection limit = span/800

$=$	1.80 in
-----	---------

Deflection due to live load and impact

$\Delta_L =$	-0.89 in
--------------	----------

OK

Deflection due to fire truck

$\Delta_L =$	-0.7986 in
--------------	------------

OK

Total Deflection after fire with fire truck

$\Delta =$	3.7567 in
------------	-----------

**Location: Fire at Critical Negative Moment Sections**  
**Beam Design: 1/2" Strand**  
**Fire Exposure Status: 4 Hour**

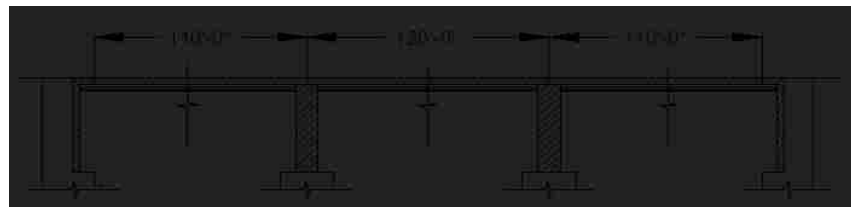
(PCI Bridge Design Manual Section 9.6)



**Material Properties**

CAST-IN-PLACE SLAB		
Actual Thickness	$t_{as} =$	8.0 in
Wearing Surface	$=$	0.5 in
Structural thickness = Actual - Wearing Surface	$t_s =$	7.5 in
Compressive Strength	$f'_c =$	2.83 ksi
Unit Weight	$w_c =$	150.0 pcf
Stress factor of compression block	$\beta_1 =$	0.85

BEAMS: AASHTO-PCI, BT-72 BULB-TEE		
Strength at release	$f'_{ci} =$	5.5 ksi
Strength at 28 days	$f'_c =$	7 ksi
Unit Weight	$w_c =$	150.0 pcf
Overall Beam Length:		
@ end spans	$L =$	110 ft
@ center span	$L =$	119 ft
Design Spans:		
Non-composite beam @ end spans	$L =$	109 ft
Non-composite beam @ center span	$L =$	118 ft
Composite beam @ end spans	$L =$	110 ft
Composite beam @ center span	$L =$	120 ft
Beam Spacing	$S =$	12 ft



**PRESTRESSING STRANDS**

Diameter of single strand	d =	0.5 in
Area of single strand	A =	0.153 in <sup>2</sup>

Temperature of Layer

layer 1 (bottom)	T =	68.00 °F
layer 2	T =	68.00 °F
layer 3	T =	68.00 °F
layer 4	T =	68.00 °F
layer 5	T =	68.00 °F
layer 6	T =	68.00 °F
layer 7	T =	68.00 °F
layer 8	T =	68.00 °F
layer 9	T =	68.00 °F
layer 10	T =	68.00 °F
layer 11	T =	68.00 °F
layer 12	T =	68.00 °F
layer 13	T =	68.00 °F
layer 14	T =	68.00 °F

Ultimate Strength

initial = 277 ksi

layer 1 (bottom)	$f_{pu}$ =	277 ksi
layer 2	$f_{pu}$ =	277 ksi
layer 3	$f_{pu}$ =	277 ksi
layer 4	$f_{pu}$ =	277 ksi
layer 5	$f_{pu}$ =	277 ksi
layer 6	$f_{pu}$ =	277 ksi
layer 7	$f_{pu}$ =	277 ksi
layer 8	$f_{pu}$ =	277 ksi
layer 9	$f_{pu}$ =	277 ksi
layer 10	$f_{pu}$ =	277 ksi
layer 11	$f_{pu}$ =	277 ksi
layer 12	$f_{pu}$ =	277 ksi
layer 13	$f_{pu}$ =	277 ksi
layer 14	$f_{pu}$ =	277 ksi

Yield Strength

initial = 250 ksi

layer 1 (bottom)	$f_{py}$ =	250 ksi
layer 2	$f_{py}$ =	250 ksi
layer 3	$f_{py}$ =	250 ksi
layer 4	$f_{py}$ =	250 ksi
layer 5	$f_{py}$ =	250 ksi
layer 6	$f_{py}$ =	250 ksi
layer 7	$f_{py}$ =	250 ksi
layer 8	$f_{py}$ =	250 ksi
layer 9	$f_{py}$ =	250 ksi
layer 10	$f_{py}$ =	250 ksi
layer 11	$f_{py}$ =	250 ksi
layer 12	$f_{py}$ =	250 ksi
layer 13	$f_{py}$ =	250 ksi
layer 14	$f_{py}$ =	250 ksi

Stress Limits:

before transfer  $\leq 0.75f_{pu}$  (initial = 207.6)

layer 1 (bottom)	$f_{pi}$ =	207.6 ksi
layer 2	$f_{pi}$ =	207.6 ksi
layer 3	$f_{pi}$ =	207.6 ksi
layer 4	$f_{pi}$ =	207.6 ksi
layer 5	$f_{pi}$ =	207.6 ksi
layer 6	$f_{pi}$ =	207.6 ksi
layer 7	$f_{pi}$ =	207.6 ksi
layer 8	$f_{pi}$ =	207.6 ksi
layer 9	$f_{pi}$ =	207.6 ksi
layer 10	$f_{pi}$ =	207.6 ksi
layer 11	$f_{pi}$ =	207.6 ksi
layer 12	$f_{pi}$ =	207.6 ksi
layer 13	$f_{pi}$ =	207.6 ksi
layer 14	$f_{pi}$ =	207.6 ksi

at service limit state (after all losses)  $\leq 0.80f_{py}$  (initial = 199.7)

layer 1 (bottom)	$f_{ps} =$	199.7 ksi
layer 2	$f_{ps} =$	199.7 ksi
layer 3	$f_{ps} =$	199.7 ksi
layer 4	$f_{ps} =$	199.7 ksi
layer 5	$f_{ps} =$	199.7 ksi
layer 6	$f_{ps} =$	199.7 ksi
layer 7	$f_{ps} =$	199.7 ksi
layer 8	$f_{ps} =$	199.7 ksi
layer 9	$f_{ps} =$	199.7 ksi
layer 10	$f_{ps} =$	199.7 ksi
layer 11	$f_{ps} =$	199.7 ksi
layer 12	$f_{ps} =$	199.7 ksi
layer 13	$f_{ps} =$	199.7 ksi
layer 14	$f_{ps} =$	199.7 ksi

Modulus of Elasticity

initial = 25982 ksi

layer 1 (bottom)	E =	25982.0 ksi
layer 2	E =	25982.0 ksi
layer 3	E =	25982.0 ksi
layer 4	E =	25982.0 ksi
layer 5	E =	25982.0 ksi
layer 6	E =	25982.0 ksi
layer 7	E =	25982.0 ksi
layer 8	E =	25982.0 ksi
layer 9	E =	25982.0 ksi
layer 10	E =	25982.0 ksi
layer 11	E =	25982.0 ksi
layer 12	E =	25982.0 ksi
layer 13	E =	25982.0 ksi
layer 14	E =	25982.0 ksi

### MILD STEEL REINFORCING BARS

Yield Strength

Layer 1 (Bottom)	$f_y =$	60.0 ksi	100.00 °F
Layer 2 (Top)	$f_y =$	44.4 ksi	1430.00 °F

Modulus of Elasticity

E =	29000.0 ksi
-----	-------------

Layer 1 (Bottom)

Area of steel at midspan (effective flange)	$A_{sm} =$	2.79 in <sup>2</sup>
Area of steel at endspan (effective flange)	$A_{se} =$	2.48 in <sup>2</sup>
Area of temperature and shrinkage steel (12" width)	$A_s =$	0.31 in <sup>2</sup>

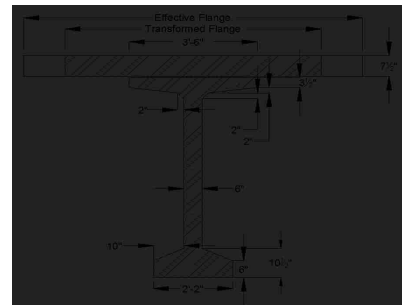
Layer 2 (Top)

Area of steel at midspan (effective flange)	$A_{sm} =$	12.6 in <sup>2</sup>
Area of steel at endspan (effective flange)	$A_{se} =$	12.4 in <sup>2</sup>
Area of temperature and shrinkage steel (12" width)	$A_s =$	0.2 in <sup>2</sup>

### Cross-sectional Properties

#### NON-COMPOSITE BEAM

Area of cross-section of beam	A =	767.0 in <sup>2</sup>
Overall depth of beam	H =	72.0 in
Moment of Inertia	I =	539,947 in <sup>4</sup>
Distance from centroid to extreme bottom fiber	$y_b =$	36.6 in
Distance from centroid to extreme top fiber	$y_t =$	35.4 in
Section modulus for the extreme bottom fiber	$S_b =$	14915.0 in <sup>3</sup>
Section modulus for the extreme top fiber	$S_t =$	15421.0 in <sup>3</sup>
Weight	$W_t =$	799.0 plf
Modulus of Elasticity = $33000 \cdot (W_c^{1.5}) \cdot (\sqrt{f_c})$		
cast-in-place concrete deck	$E_{cs} =$	3225 ksi
precast beam at release	$E_{ci} =$	4496 ksi
precast beam at service loads	$E_c =$	5072 ksi





### COMPOSITE BEAM AT MIDSPAN

Effective Flange Width	$b_f =$	111.0 in	*min of three criteria
Modular Ratio = $E_{cs}/E_c$	$n =$	0.6358	
Transformed flange width	$=$	70.6 in	
Transformed flange area	$=$	529.3 in <sup>2</sup>	
Transformed haunch width	$=$	26.7 in	
Transformed haunch area	$=$	13.4 in <sup>2</sup>	
Deck-distance to top fiber	$y_t =$	5.83 in	

	Transformed Area	$y_b$	$Ay_b$	$A(y_{bc}-y_b)^2$	$I$	$I + A(y_{bc}-y_b)^2$
Beam	767.0 in <sup>2</sup>	36.60 in	28,072.2 in <sup>3</sup>	185,416 in <sup>4</sup>	539,947 in <sup>4</sup>	725,363 in <sup>4</sup>
Haunch	13.4 in <sup>2</sup>	72.25 in	964.7 in <sup>3</sup>	5,396 in <sup>4</sup>	0.33 in <sup>4</sup>	5,396 in <sup>4</sup>
Deck	529.3 in <sup>2</sup>	74.17 in	39,260.6 in <sup>3</sup>	256,709 in <sup>4</sup>	692 in <sup>4</sup>	257,400 in <sup>4</sup>
Total	1309.7 in <sup>2</sup>		68,297.5 in <sup>3</sup>			988,159 in <sup>4</sup>

Total area of Composite Section	$A_c =$	1310 in <sup>2</sup>
Overall Depth of the Composite Section	$h_c =$	80 in
Moment of Inertia	$I_c =$	988,159 in <sup>4</sup>
Distance from centroid to extreme <u>bottom</u> fiber of beam	$y_{bc} =$	52.15 in
Distance from centroid to extreme <u>top</u> fiber of beam	$y_{tg} =$	19.85 in
Distance from centroid to extreme <u>top</u> fiber of slab	$y_{tc} =$	27.85 in
Section modulus for the extreme <u>bottom</u> fiber of beam	$S_{bc} =$	18,949.1 in <sup>3</sup>
Section modulus for the extreme <u>top</u> fiber of beam	$S_{tg} =$	49,776.4 in <sup>3</sup>
Section modulus for the extreme <u>top</u> fiber slab	$S_{tc} =$	55,799.1 in <sup>3</sup>

### COMPOSITE BEAM AT ENDSPAN

Effective Flange Width	$b_f =$	106.6 in	*min of three criteria
Modular Ratio = $E_{cs}/E_c$	$n =$	0.6358	
Transformed flange width	$=$	67.8 in	
Transformed flange area	$=$	508.3 in <sup>2</sup>	
Transformed haunch width	$=$	26.7 in	
Transformed haunch area	$=$	13.4 in <sup>2</sup>	
Deck-distance to top fiber	$y_{td} =$	5.83 in	

	Transformed Area	$y_t$	$Ay_t$	$A(y_{tc}-y_t)^2$	$I$	$I + A(y_{tc}-y_t)^2$
Beam	767.0 in <sup>2</sup>	36.60 in	28,072.2 in <sup>3</sup>	249,350 in <sup>4</sup>	539,947 in <sup>4</sup>	789,297 in <sup>4</sup>
Haunch	13.4 in <sup>2</sup>	72.25 in	964.7 in <sup>3</sup>	4,341 in <sup>4</sup>	0.28 in <sup>4</sup>	4,341 in <sup>4</sup>
Deck	508.3 in <sup>2</sup>	78.33 in	39,819.0 in <sup>3</sup>	165,263 in <sup>4</sup>	666 in <sup>4</sup>	165,929 in <sup>4</sup>
Total	1288.7 in <sup>2</sup>		68,856.0 in <sup>3</sup>			959,567 in <sup>4</sup>

Total area of Composite Section	$A_c =$	1289 in <sup>2</sup>
Overall Depth of the Composite Section	$h_c =$	80 in
Moment of Inertia	$I_c =$	959,567 in <sup>4</sup>
Distance from centroid to extreme <u>bottom</u> fiber of beam	$y_{bc} =$	53.43 in
Distance from centroid to extreme <u>top</u> fiber of beam	$y_{tg} =$	18.57 in
Distance from centroid to extreme <u>top</u> fiber of slab	$y_{tc} =$	26.57 in
Section modulus for the extreme <u>bottom</u> fiber of beam	$S_{bc} =$	17,959.2 in <sup>3</sup>
Section modulus for the extreme <u>top</u> fiber of beam	$S_{tg} =$	51,674.2 in <sup>3</sup>
Section modulus for the extreme <u>top</u> fiber slab	$S_{tc} =$	36,115.3 in <sup>3</sup>

### Shear Forces and Bending Moments

#### DEAD LOADS

Beam self-weight	$w_{beam} =$	0.799 k/f
8 in. deck weight	$w_{deck} =$	1.200 k/f
1/2 in. haunch weight	$w_{haunch} =$	0.022 k/f

#### LRFD Specifications: Art. 4.6.2.2.1

Width of Deck Constant		OK
Number of beams is not less than four $N_b =$	4	OK
Roadway part of the overhang, $d_o \leq 3.0$ ft, $d_o =$	1.5	OK
Curvature in plans is less than $4^\circ =$	0	OK
Cross-section of the bridge is consistent with one of the cross sections given by LRFD specs		OK

Barrier and wearing surface loads are equally distributed among the 4 beams

Barrier Wt	$W_t =$	0.150 k/f
Dead load of future wearing surface	$DW =$	0.263 k/f

LIVE LOADS		
Fire truck live load front load (Point A)	$P_{live} =$	48.0 kips
Fire truck live load back load (Point B)	$P_{live} =$	22.0 kips
distance between two loads		19.2 ft
distance from nearest edge to point A	$x_a =$	59.0 ft
distance from nearest edge to point B	$x_b =$	39.8 ft
LRFD Specifications: Art. 4.6.2.2.1		
Width of Deck Constant		OK
Number of beams is not less than four $N_b =$	4	OK
Beams are parallel and approximately of the same stiffness		OK
Roadway part of the overhang, $d_o \leq 3.0$ ft, $d_o =$	1.5	OK
Curvature in plans is less than $4^\circ =$	0	OK

Barrier and wearing surface loads are equally distributed among the 4 beams

Bridge Type-- "k" (LRFD Table 4.6.2.2.1-1)		
Number of design lanes = $w/12$	=	3 lanes

**Distribution Factor for Bending Moment:**

Beams spacing	$S =$	12.0 ft
Depth of concrete slab	$t_s =$	7.5 in
Beam Span	$L =$	120.0 ft
Number of Beams	$N_b =$	4
Modular ratio between beam & deck materials	$n =$	1.5727
Longitudinal stiffness parameter	$K_g =$	2,745,627.23 in <sup>4</sup>

at center span:		
$DFM = 0.75 + \left(\frac{S}{9.5}\right)^{0.6} * \left(\frac{S}{L}\right)^{0.2} * \left(\frac{K_g}{12 * L * t_s^3}\right)^{0.1}$		
	DFM =	0.919 lanes/beam

0.905 Controls

one design lane loaded:		
$DFM = 0.75 + \left(\frac{S}{14}\right)^{0.4} * \left(\frac{S}{L}\right)^{0.2} * \left(\frac{K_g}{12 * L * t_s^3}\right)^{0.1}$		
	DFM =	0.623 lanes/beam

**Distribution Factor for Shear Force**

both end spans and center span:		
$DFV = 0.2 + \left(\frac{S}{12}\right) - \left(\frac{S}{35}\right)^2$		
	DFV =	1.082 lanes/beam

1.082 Controls

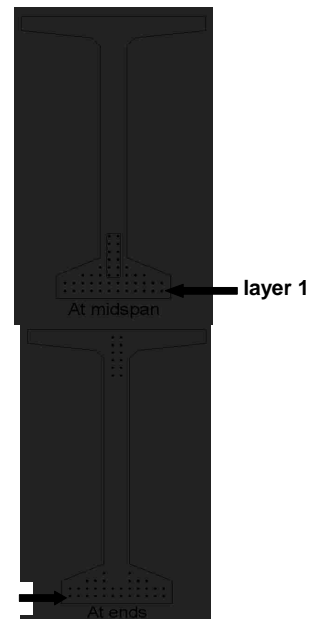
one design lane loaded:		
$DFV = 0.36 + \left(\frac{S}{25}\right)$		
	DFV =	0.840 lanes/beam

	At Midspan		At Ends	
from bottom	No. of	Distance from Bottom	No. of	Distance from Bottom
layer 1	12	2	12	2
layer 2	12	4	12	4
layer 3	8	6	6	6
layer 4	4	8	2	8
layer 5	2	10	-	-
layer 6	2	12	-	-
layer 7	2	14	-	-
layer 8	2	16	-	-
layer 9	-	-	2	60
layer 10	-	-	2	62
layer 11	-	-	2	64
layer 12	-	-	2	66
layer 13	-	-	2	68
layer 14	-	-	2	70
<b>Harped Strand Group (included in above totals)</b>				
layer 3	2	6		
layer 4	2	8		
layer 5	2	10		
layer 6	2	12		
layer 7	2	14		
layer 8	2	16		

distance from the center of gravity of strands to the bottom fiber of the beam = 7% of the beam depth  
strand eccentricity at midspan =  $(y_b - y_{bs})$

$y_{bs} =$	5.82 in
$e_c =$	30.78 in

layer 1



**Prestress Losses**

**ELASTIC SHORTENING**

assumed loss	=	9.00%
Force per strand at transfer		
layer 1	=	28.9 kips
layer 2	=	28.9 kips
layer 3	=	28.9 kips
layer 4	=	28.9 kips
layer 5	=	28.9 kips
layer 6	=	28.9 kips
layer 7	=	28.9 kips
layer 8	=	28.9 kips
layer 9	=	28.9 kips
layer 10	=	28.9 kips
layer 11	=	28.9 kips
layer 12	=	28.9 kips
layer 13	=	28.9 kips
layer 14	=	28.9 kips

		<b>at midspan</b>	<b>at endspan</b>
Total prestressing force at release	$P_i =$	1271.6 kips	1271.6 kips
Sum of concrete stresses at the center of gravity of prestressing tendons due to prestressing force at transfer and the self-weight of the member at sections of maximum moment	$f_{cgp} =$	2.938 ksi	2.938 ksi
Loss due to shortening		<b>at midspan</b>	<b>at endspan</b>
layer 1	$\Delta f_{PES} =$	17.0 ksi	17.0 ksi
layer 2	$\Delta f_{PES} =$	17.0 ksi	17.0 ksi
layer 3	$\Delta f_{PES} =$	17.0 ksi	17.0 ksi
layer 4	$\Delta f_{PES} =$	17.0 ksi	17.0 ksi
layer 5	$\Delta f_{PES} =$	17.0 ksi	
layer 6	$\Delta f_{PES} =$	17.0 ksi	
layer 7	$\Delta f_{PES} =$	17.0 ksi	
layer 8	$\Delta f_{PES} =$	17.0 ksi	
layer 9	$\Delta f_{PES} =$		17.0 ksi
layer 10	$\Delta f_{PES} =$		17.0 ksi
layer 11	$\Delta f_{PES} =$		17.0 ksi
layer 12	$\Delta f_{PES} =$		17.0 ksi
layer 13	$\Delta f_{PES} =$		17.0 ksi
layer 14	$\Delta f_{PES} =$		17.0 ksi

**SHRINKAGE**

Shrinkage = (17-0.15*Relative Humidity)	$\Delta f_{PSR} =$	6.5 ksi	← assume relative humidity = 70%
---	--------------------	---------	----------------------------------

**CREEP OF CONCRETE**

Change of stresses at center of gravity of prestressing due to permanent loads except the loads acting at time of applying prestressing force, calculated at the same section as $f_{cgp}$	$\Delta f_{cdp} =$	1.568 ksi	
loss due to creep		<b>at midspan</b>	<b>at endspan</b>
	$\Delta f_{PCR} =$	24.3 ksi	24.3 ksi

**RELAXATION OF PRESTRESSING STRANDS**

loss due to relaxation after transfer		<b>at midspan</b>	<b>at endspan</b>
layer 1	$\Delta f_{PR2} =$	2.1 ksi	2.1 ksi
layer 2	$\Delta f_{PR2} =$	2.1 ksi	2.1 ksi
layer 3	$\Delta f_{PR2} =$	2.1 ksi	2.1 ksi
layer 4	$\Delta f_{PR2} =$	2.1 ksi	2.1 ksi
layer 5	$\Delta f_{PR2} =$	2.1 ksi	
layer 6	$\Delta f_{PR2} =$	2.1 ksi	
layer 7	$\Delta f_{PR2} =$	2.1 ksi	
layer 8	$\Delta f_{PR2} =$	2.1 ksi	
layer 9	$\Delta f_{PR2} =$		2.1 ksi
layer 10	$\Delta f_{PR2} =$		2.1 ksi
layer 11	$\Delta f_{PR2} =$		2.1 ksi
layer 12	$\Delta f_{PR2} =$		2.1 ksi
layer 13	$\Delta f_{PR2} =$		2.1 ksi
layer 14	$\Delta f_{PR2} =$		2.1 ksi

**TOTAL LOSSES AT TRANSFER**

total loss  $\Delta f_{pES} = \Delta f_{pi}$

stress in tendons after transfer  $f_{pi} = f_{pr} - \Delta f_{pi}$

		at midspan	at endspan
layer 1	$f_{pi} =$	190.6 ksi	190.6 ksi
layer 2	$f_{pi} =$	190.6 ksi	190.6 ksi
layer 3	$f_{pi} =$	190.6 ksi	190.6 ksi
layer 4	$f_{pi} =$	190.6 ksi	190.6 ksi
layer 5	$f_{pi} =$	190.6 ksi	
layer 6	$f_{pi} =$	190.6 ksi	
layer 7	$f_{pi} =$	190.6 ksi	
layer 8	$f_{pi} =$	190.6 ksi	
layer 9	$f_{pi} =$		190.6 ksi
layer 10	$f_{pi} =$		190.6 ksi
layer 11	$f_{pi} =$		190.6 ksi
layer 12	$f_{pi} =$		190.6 ksi
layer 13	$f_{pi} =$		190.6 ksi
layer 14	$f_{pi} =$		190.6 ksi

force per strand =  $f_{pi} \times \text{strand area}$

		at midspan	at endspan
layer 1	=	29.2 kips	29.2 kips
layer 2	=	29.2 kips	29.2 kips
layer 3	=	29.2 kips	29.2 kips
layer 4	=	29.2 kips	29.2 kips
layer 5	=	29.2 kips	
layer 6	=	29.2 kips	
layer 7	=	29.2 kips	
layer 8	=	29.2 kips	
layer 9	=		29.2 kips
layer 10	=		29.2 kips
layer 11	=		29.2 kips
layer 12	=		29.2 kips
layer 13	=		29.2 kips
layer 14	=		29.2 kips

Total prestressing force after transfer

Initial loss =  $(\Delta f_{pi}) / (f_{pi})$

		at midspan	at endspan
P <sub>i</sub> =		1284.8 kips	1284.8 kips
layer 1	% =	8.2%	8.2%
layer 2	% =	8.2%	8.2%
layer 3	% =	8.2%	8.2%
layer 4	% =	8.2%	8.2%
layer 5	% =	8.2%	
layer 6	% =	8.2%	
layer 7	% =	8.2%	
layer 8	% =	8.2%	
layer 9	% =		8.2%
layer 10	% =		8.2%
layer 11	% =		8.2%
layer 12	% =		8.2%
layer 13	% =		8.2%
layer 14	% =		8.2%

OK  
OK  
OK  
OK  
OK  
OK  
OK  
OK  
OK  
OK  
OK  
OK  
OK  
OK

**TOTAL LOSSES AT SERVICE LOADS**

Total Losses

		at midspan	at endspan
layer 1	$\Delta f_{pT} =$	49.9 ksi	49.9 ksi
layer 2	$\Delta f_{pT} =$	49.9 ksi	49.9 ksi
layer 3	$\Delta f_{pT} =$	49.9 ksi	49.9 ksi
layer 4	$\Delta f_{pT} =$	49.9 ksi	49.9 ksi
layer 5	$\Delta f_{pT} =$	49.9 ksi	
layer 6	$\Delta f_{pT} =$	49.9 ksi	
layer 7	$\Delta f_{pT} =$	49.9 ksi	
layer 8	$\Delta f_{pT} =$	49.9 ksi	
layer 9	$\Delta f_{pT} =$		49.9 ksi
layer 10	$\Delta f_{pT} =$		49.9 ksi
layer 11	$\Delta f_{pT} =$		49.9 ksi
layer 12	$\Delta f_{pT} =$		49.9 ksi
layer 13	$\Delta f_{pT} =$		49.9 ksi
layer 14	$\Delta f_{pT} =$		49.9 ksi

Stress in tendon after all losses =  $f_{pe} - \Delta f_{pt}$

		at midspan	at endspan
layer 1	$f_{pe} =$	157.7 ksi	157.7 ksi
layer 2	$f_{pe} =$	157.7 ksi	157.7 ksi
layer 3	$f_{pe} =$	157.7 ksi	157.7 ksi
layer 4	$f_{pe} =$	157.7 ksi	157.7 ksi
layer 5	$f_{pe} =$	157.7 ksi	
layer 6	$f_{pe} =$	157.7 ksi	
layer 7	$f_{pe} =$	157.7 ksi	
layer 8	$f_{pe} =$	157.7 ksi	
layer 9	$f_{pe} =$		157.7 ksi
layer 10	$f_{pe} =$		157.7 ksi
layer 11	$f_{pe} =$		157.7 ksi
layer 12	$f_{pe} =$		157.7 ksi
layer 13	$f_{pe} =$		157.7 ksi
layer 14	$f_{pe} =$		157.7 ksi

check prestressing stress limit at service limit state:  $f_{pe} \leq 0.8 \cdot f_{py}$

layer 1	=	199.7 ksi
layer 2	=	199.7 ksi
layer 3	=	199.7 ksi
layer 4	=	199.7 ksi
layer 5	=	199.7 ksi
layer 6	=	199.7 ksi
layer 7	=	199.7 ksi
layer 8	=	199.7 ksi
layer 9	=	199.7 ksi
layer 10	=	199.7 ksi
layer 11	=	199.7 ksi
layer 12	=	199.7 ksi
layer 13	=	199.7 ksi
layer 14	=	199.7 ksi

OK  
OK  
OK  
OK  
OK  
OK  
OK  
OK  
OK  
OK  
OK  
OK  
OK  
OK

force per strand =  $f_{pe} \cdot \text{strand area}$

		at midspan	at endspan
layer 1	=	24.1 kips	24.1 kips
layer 2	=	24.1 kips	24.1 kips
layer 3	=	24.1 kips	24.1 kips
layer 4	=	24.1 kips	24.1 kips
layer 5	=	24.1 kips	
layer 6	=	24.1 kips	
layer 7	=	24.1 kips	
layer 8	=	24.1 kips	
layer 9	=		24.1 kips
layer 10	=		24.1 kips
layer 11	=		24.1 kips
layer 12	=		24.1 kips
layer 13	=		24.1 kips
layer 14	=		24.1 kips

Total prestressing force after all losses

		at midspan	at endspan
$P_{pe} =$		1061.8 kips	1061.8 kips

Final losses, % =  $(\Delta f_{pt}) / (f_{pe})$

layer 1	% =	24.0%	24.0%
layer 2	% =	24.0%	24.0%
layer 3	% =	24.0%	24.0%
layer 4	% =	24.0%	24.0%
layer 5	% =	24.0%	
layer 6	% =	24.0%	
layer 7	% =	24.0%	
layer 8	% =	24.0%	
layer 9	% =		24.0%
layer 10	% =		24.0%
layer 11	% =		24.0%
layer 12	% =		24.0%
layer 13	% =		24.0%
layer 14	% =		24.0%
Average final losses, %	% =	24.0%	24.0%

## Stresses at Transfer

### STRESS LIMITS FOR CONCRETE

Compression = $0.6f_{ci}$	$f_{ci} =$	3.300 ksi
Tension		
without bonded reinforcement = $-0.0948\sqrt{f_{ci}} \leq -0.2$	=	-0.200 ksi
with bonded auxiliary reinforcement = $-0.22\sqrt{f_{ci}}$	=	-0.016 ksi

### STRESSES AT TRANSFER LENGTH SECTION

Transfer Length = $60 \times (\text{strand diameter})$	=	2.5 ft	} Calcs for eccentricity (see 9.6.7.2)
Bending moment at transfer length	$M_0 =$	116.4 ft-kips	
center of 12 strands to top fiber of beam at the end	=	7.00 in	
center of 12 strands to bottom fiber of beam at the harp point	=	11.00 in	
center of 12 strands and top fiber of beam at transfer length	=	10.78 in	
center of gravity of 32 strands and bottom fiber of beam	=	3.88 in	
center of gravity of all strands and the bottom fiber of beam at transfer length	=	19.51 in	
center of gravity of all strands and the bottom fiber of beam at the end	=	20.55 in	
Eccentricity of the strand group at transfer length:	$e_n =$	17.09 in	
Eccentricity at end of beam:	$e =$	16.05 in	

$$f_t = \frac{P_i}{A} - \frac{P_i e}{S_t} + \frac{M_f}{S_t} \qquad f_b = \frac{P_i}{A} + \frac{P_i e}{S_b} - \frac{M_f}{S_b}$$

		at midspan	at endspan	
Top stress at top fiber of beam	$f_t =$	0.342 ksi	0.342 ksi	OK
Bottom stress at bottom fiber of the beam	$f_b =$	3.021 ksi	3.021 ksi	OK

### STRESSES AT HARP POINT

Bending moment due to beam weight at 0.3L	$M_0 =$	1188.0 ft-kips		
Top stress at top fiber of beam	$f_t =$	0.035 ksi	0.035 ksi	OK
Bottom stress at bottom fiber of the beam	$f_b =$	3.300 ksi	3.300 ksi	OK

### STRESSES AT MIDSPAN

Bending moment due to beam weight at 0.5L	$M_0 =$	1414.3 ft-kips		
Top stress at top fiber of beam	$f_t =$	0.220 ksi	0.211 ksi	OK
Bottom stress at bottom fiber of the beam	$f_b =$	3.144 ksi	3.189 ksi	OK

### HOLD-DOWN FORCES

assume stress in strand before losses =  $0.8f_u$

layer 1	=	221.4 ksi
layer 2	=	221.4 ksi
layer 3	=	221.4 ksi
layer 4	=	221.4 ksi
layer 5	=	221.4 ksi
layer 6	=	221.4 ksi
layer 7	=	221.4 ksi
layer 8	=	221.4 ksi
layer 9	=	221.4 ksi
layer 10	=	221.4 ksi
layer 11	=	221.4 ksi
layer 12	=	221.4 ksi
layer 13	=	221.4 ksi
layer 14	=	221.4 ksi

prestress force per strand before any losses:

layer 1	=	33.9 kips
layer 2	=	33.9 kips
layer 3	=	33.9 kips
layer 4	=	33.9 kips
layer 5	=	33.9 kips
layer 6	=	33.9 kips
layer 7	=	33.9 kips
layer 8	=	33.9 kips
layer 9	=	33.9 kips
layer 10	=	33.9 kips
layer 11	=	33.9 kips
layer 12	=	33.9 kips
layer 13	=	33.9 kips
layer 14	=	33.9 kips
Harp Angle	$\psi =$	7.2 °

Hold-down force/strand

layer 1	=	4.4 kips/strand
layer 2	=	4.4 kips/strand
layer 3	=	4.4 kips/strand
layer 4	=	4.4 kips/strand
layer 5	=	4.4 kips/strand
layer 6	=	4.4 kips/strand
layer 7	=	4.4 kips/strand
layer 8	=	4.4 kips/strand
layer 9	=	4.4 kips/strand
layer 10	=	4.4 kips/strand
layer 11	=	4.4 kips/strand
layer 12	=	4.4 kips/strand
layer 13	=	4.4 kips/strand
layer 14	=	4.4 kips/strand
Total hold-down force	=	53.39 kips

**Stresses at Service Loads**

**STRESS LIMITS FOR CONCRETE**

**Compression:**

Due to permanent loads for load combination Service I

for the precast beam	=	3.150 ksi
for deck	=	1.274 ksi

Due to permanent and transient loads for load combination Service I

for the precast beam	=	4.200 ksi
for deck	=	1.698 ksi

**Tension:**

Load Combination Service III

for the precast beam	=	-0.016 ksi
----------------------	---	------------

**STRESSES AT MIDSPAN**

Compression stresses at top fiber of beam	at midspan	at endspan	
$f_c = \frac{P_{ps}}{A} - \frac{P_{ps}e}{S_x} + \frac{(M_D + M_L)}{S_x} + \frac{(M_{ws} + M_s)}{S_{tr}}$			
Due to permanent loads	$f_{ic} =$	2.051 ksi	2.051 ksi
$f_{tr} = \frac{P_{ps}}{A} - \frac{P_{ps}e}{S_x} + \frac{(M_D + M_L)}{S_x} + \frac{(M_{ws} + M_s)}{S_{tr}} + \frac{(M_{LL+1})}{S_{tr}}$			
Due to permanent loads and transient loads	$f_{ic} =$	2.560 ksi	2.560 ksi
<b>Compression stresses at top fiber of deck</b>	<b>at midspan</b>	<b>at endspan</b>	
$f_{ic} = \frac{(M_{ws} + M_s)}{S_{tr}}$			
Due to permanent loads	$f_{ic} =$	0.043 ksi	0.043 ksi
$f_{ic} = \frac{(M_{ws} + M_s + M_{LL+1})}{S_{tr}}$			
Due to permanent loads and transient loads	$f_{ic} =$	0.498 ksi	0.498 ksi
<b>Tension stresses at top fiber of deck</b>	<b>at midspan</b>	<b>at endspan</b>	
$f_{tr} = \frac{P_{ps}}{A} - \frac{P_{ps}e}{S_x} - \frac{(M_D + M_L)}{S_x} - \frac{(M_{ws} + M_s + 0.8 * M_{LL+1})}{S_{tr}}$			
Load Combination Service III	$f_b =$	-0.453 ksi	-0.453 ksi

OK

OK

OK

OK

OK



**Strength Limit State**

POSITIVE MOMENT SECTION		
$M_u = 1.25DC+1.5DW+1.75(LL+IM)$	$M_u =$	8381.5 ft-kips

effective length factor for compression members

layer 1	k =	0.28
layer 2	k =	0.28
layer 3	k =	0.28
layer 4	k =	0.28
layer 5	k =	0.28
layer 6	k =	0.28
layer 7	k =	0.28
layer 8	k =	0.28
layer 9	k =	0.28
layer 10	k =	0.28
layer 11	k =	0.28
layer 12	k =	0.28
layer 13	k =	0.28
layer 14	k =	0.28
	c =	8.0 ft-kips

average stress in prestressing steel

layer 1	$f_{ps} =$	268.6 ksi
layer 2	$f_{ps} =$	268.6 ksi
layer 3	$f_{ps} =$	268.6 ksi
layer 4	$f_{ps} =$	268.6 ksi
layer 5	$f_{ps} =$	268.6 ksi
layer 6	$f_{ps} =$	268.6 ksi
layer 7	$f_{ps} =$	268.6 ksi
layer 8	$f_{ps} =$	268.6 ksi
layer 9	$f_{ps} =$	268.6 ksi
layer 10	$f_{ps} =$	268.6 ksi
layer 11	$f_{ps} =$	268.6 ksi
layer 12	$f_{ps} =$	268.6 ksi
layer 13	$f_{ps} =$	268.6 ksi
layer 14	$f_{ps} =$	268.6 ksi

nominal flexure resistance

	a =	6.79 in
$M_r = \Phi M_n, \Phi = 1.00$	$\Phi M_n =$	10664.7 ft-kips
M=DC+W+LL+IM	M =	5833.6 ft-kips

OK

OK

NEGATIVE MOMENT SECTION		
$M_u = 1.25DC+1.5DW+1.75(LL+IM)$	$M_u =$	-4837.2 ft-kips
	a =	4.70 in
	$\Phi M_n =$	3876.2 ft-kips
M=DC+W+LL+IM	M =	-2869.7 ft-kips

NOT OK

OK



## Shear Design

CRITICAL SECTION AT 0.59			
$V_u = 1.25DC + 1.5DW + 1.75(LL + IM)$	$V_u =$	405.0 kips	
$M_u = 1.25DC + 1.5DW + 1.75(LL + IM)$	$M_u =$	-2684.4 ft-kips	
or			
$V_u = 1.25DC + 1.5DW + 1.75(LL + IM)$	$V_u =$	364.8 kips	
$M_u = 1.25DC + 1.5DW + 1.75(LL + IM)$	$M_u =$	-2877.0 ft-kips	
max shear	$V_u =$	405.0 kips	
max moment	$M_u =$	2877.0 ft-kips	
Shear depth	$d_v =$	73.19 in	
Applied factored normal force at the section	$N_u =$	0	
Angle of diagonal compressive stresses	$\theta =$	36.00 °	

### STRAIN IN FLEXURAL TENSION REINFORCEMENT

$$\epsilon_x = \frac{\frac{M_u}{d_v} + 0.5N_u + 0.5V_u \cot \theta - A_{ps} f_{ps}}{E_s A_s + E_p A_{ps}} \leq 0.002$$

	at midspan	at endspan	
resultant compressive stress at centroid	$f_{pc} =$	1.048 ksi	1.048 ksi

effective stress in prestressing strand after all losses

layer 1	$f_{po} =$	163.1 ksi	163.1 ksi
layer 2	$f_{po} =$	163.1 ksi	163.1 ksi
layer 3	$f_{po} =$	163.1 ksi	163.1 ksi
layer 4	$f_{po} =$	163.1 ksi	163.1 ksi
layer 5	$f_{po} =$	163.1 ksi	
layer 6	$f_{po} =$	163.1 ksi	
layer 7	$f_{po} =$	163.1 ksi	
layer 8	$f_{po} =$	163.1 ksi	
layer 9	$f_{po} =$		163.1 ksi
layer 10	$f_{po} =$		163.1 ksi
layer 11	$f_{po} =$		163.1 ksi
layer 12	$f_{po} =$		163.1 ksi
layer 13	$f_{po} =$		163.1 ksi
layer 14	$f_{po} =$		163.1 ksi

strain in flexural tension

	at midspan	at endspan	
layer 1	$\epsilon_x =$	0.002000	0.002000
layer 2	$\epsilon_x =$	0.002000	0.002000
layer 3	$\epsilon_x =$	0.002000	0.002000
layer 4	$\epsilon_x =$	0.002000	0.002000
layer 5	$\epsilon_x =$	0.002000	
layer 6	$\epsilon_x =$	0.002000	
layer 7	$\epsilon_x =$	0.002000	
layer 8	$\epsilon_x =$	0.002000	
layer 9	$\epsilon_x =$		0.002000
layer 10	$\epsilon_x =$		0.002000
layer 11	$\epsilon_x =$		0.002000
layer 12	$\epsilon_x =$		0.002000
layer 13	$\epsilon_x =$		0.002000
layer 14	$\epsilon_x =$		0.002000

## Deflection and Camber

	at midspan	at endspan	
Deflection due to Prestressing Force at Transfer	$\Delta_p =$	3.97 in	3.97 in
Deflection due to Beam Self-Weight at Transfer	$\Delta_g =$	-1.49 in	
Deflection due to Beam Self-Weight at Erection	$\Delta_g =$	-1.44 in	
Deflection due to Haunch and Deck	$\Delta_g =$	-1.95 in	

Deflection due to total self weight

$\Delta_{sw} =$	0.59 in
-----------------	---------

Total Deflection at transfer

$\Delta =$	2.48 in	2.48 in
------------	---------	---------

Total Deflection at erection

$\Delta =$	4.49 in	4.49 in
------------	---------	---------

Live load deflection limit = span/800

$\Delta_L =$	1.80 in
--------------	---------

Deflection due to live load and impact

$\Delta_L =$	-0.90 in
--------------	----------

OK

Deflection due to fire truck

$\Delta_L =$	-0.8130 in
--------------	------------

OK

Total Deflection after fire with fire truck

$\Delta =$	3.7423 in
------------	-----------

**Location: Fire at Critical Negative Moment Sections**  
**Beam Design: 3/8" Strand**  
**Fire Exposure Status: Undamaged**

(PCI Bridge Design Manual Section 9.6)

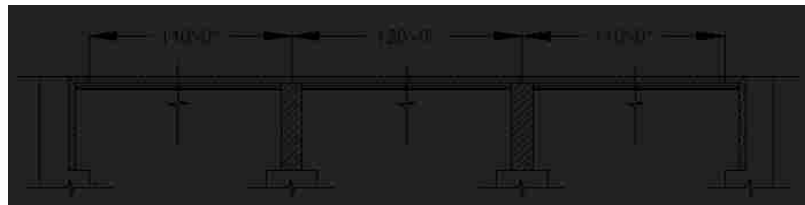


**Material Properties**

CAST-IN-PLACE SLAB		
Actual Thickness	$t_{as} =$	8.0 in
Wearing Surface	$=$	0.5 in
Structural thickness = Actual - Wearing Surface	$t_s =$	7.5 in
Compressive Strength	$f'_c =$	4.00 ksi
Unit Weight	$w_c =$	150.0 pcf
Stress factor of compression block	$\beta_1 =$	0.85

BEAMS: AASHTO-PCI, BT-72 BULB-TEE		
Strength at release	$f'_{ci} =$	5.5 ksi
Strength at 28 days	$f'_c =$	7 ksi
Unit Weight	$w_c =$	150.0 pcf
Overall Beam Length:		
@ end spans	$L =$	110 ft
@ center span	$L =$	119 ft
Design Spans:		
Non-composite beam @ end spans	$L =$	109 ft
Non-composite beam @ center span	$L =$	118 ft
Composite beam @ end spans	$L =$	110 ft
Composite beam @ center span	$L =$	120 ft
Beam Spacing	$S =$	12 ft



**PRESTRESSING STRANDS**

Diameter of single strand	d =	0.4 in
Area of single strand	A =	0.085 in <sup>2</sup>

Temperature of Layer

layer 1 (bottom)	T =	68.00 °F
layer 2	T =	68.00 °F
layer 3	T =	68.00 °F
layer 4	T =	68.00 °F
layer 5	T =	68.00 °F
layer 6	T =	68.00 °F
layer 7	T =	68.00 °F
layer 8	T =	68.00 °F
layer 9	T =	68.00 °F
layer 10	T =	68.00 °F
layer 11	T =	68.00 °F
layer 12	T =	68.00 °F
layer 13	T =	68.00 °F
layer 14	T =	68.00 °F

Ultimate Strength

initial = 284 ksi

layer 1 (bottom)	f <sub>pu</sub> =	284 ksi
layer 2	f <sub>pu</sub> =	284 ksi
layer 3	f <sub>pu</sub> =	284 ksi
layer 4	f <sub>pu</sub> =	284 ksi
layer 5	f <sub>pu</sub> =	284 ksi
layer 6	f <sub>pu</sub> =	284 ksi
layer 7	f <sub>pu</sub> =	284 ksi
layer 8	f <sub>pu</sub> =	284 ksi
layer 9	f <sub>pu</sub> =	284 ksi
layer 10	f <sub>pu</sub> =	284 ksi
layer 11	f <sub>pu</sub> =	284 ksi
layer 12	f <sub>pu</sub> =	284 ksi
layer 13	f <sub>pu</sub> =	284 ksi
layer 14	f <sub>pu</sub> =	284 ksi

Yield Strength

initial = 257 ksi

layer 1 (bottom)	f <sub>py</sub> =	257 ksi
layer 2	f <sub>py</sub> =	257 ksi
layer 3	f <sub>py</sub> =	257 ksi
layer 4	f <sub>py</sub> =	257 ksi
layer 5	f <sub>py</sub> =	257 ksi
layer 6	f <sub>py</sub> =	257 ksi
layer 7	f <sub>py</sub> =	257 ksi
layer 8	f <sub>py</sub> =	257 ksi
layer 9	f <sub>py</sub> =	257 ksi
layer 10	f <sub>py</sub> =	257 ksi
layer 11	f <sub>py</sub> =	257 ksi
layer 12	f <sub>py</sub> =	257 ksi
layer 13	f <sub>py</sub> =	257 ksi
layer 14	f <sub>py</sub> =	257 ksi

**Stress Limits:**

before transfer ≤ 0.75f<sub>pu</sub> (initial = 213.2)

layer 1 (bottom)	f <sub>di</sub> =	213.2 ksi
layer 2	f <sub>di</sub> =	213.2 ksi
layer 3	f <sub>di</sub> =	213.2 ksi
layer 4	f <sub>di</sub> =	213.2 ksi
layer 5	f <sub>di</sub> =	213.2 ksi
layer 6	f <sub>di</sub> =	213.2 ksi
layer 7	f <sub>di</sub> =	213.2 ksi
layer 8	f <sub>di</sub> =	213.2 ksi
layer 9	f <sub>di</sub> =	213.2 ksi
layer 10	f <sub>di</sub> =	213.2 ksi
layer 11	f <sub>di</sub> =	213.2 ksi
layer 12	f <sub>di</sub> =	213.2 ksi
layer 13	f <sub>di</sub> =	213.2 ksi
layer 14	f <sub>di</sub> =	213.2 ksi

at service limit state (after all losses)  $\leq 0.80f_{py}$  (initial = 205.4)

layer 1 (bottom)	$f_{pe} =$	205.4 ksi
layer 2	$f_{pe} =$	205.4 ksi
layer 3	$f_{pe} =$	205.4 ksi
layer 4	$f_{pe} =$	205.4 ksi
layer 5	$f_{pe} =$	205.4 ksi
layer 6	$f_{pe} =$	205.4 ksi
layer 7	$f_{pe} =$	205.4 ksi
layer 8	$f_{pe} =$	205.4 ksi
layer 9	$f_{pe} =$	205.4 ksi
layer 10	$f_{pe} =$	205.4 ksi
layer 11	$f_{pe} =$	205.4 ksi
layer 12	$f_{pe} =$	205.4 ksi
layer 13	$f_{pe} =$	205.4 ksi
layer 14	$f_{pe} =$	205.4 ksi

Modulus of Elasticity

initial = 25898 ksi

layer 1 (bottom)	E =	25898.0 ksi
layer 2	E =	25898.0 ksi
layer 3	E =	25898.0 ksi
layer 4	E =	25898.0 ksi
layer 5	E =	25898.0 ksi
layer 6	E =	25898.0 ksi
layer 7	E =	25898.0 ksi
layer 8	E =	25898.0 ksi
layer 9	E =	25898.0 ksi
layer 10	E =	25898.0 ksi
layer 11	E =	25898.0 ksi
layer 12	E =	25898.0 ksi
layer 13	E =	25898.0 ksi
layer 14	E =	25898.0 ksi

#### MILD STEEL REINFORCING BARS

Yield Strength

Layer 1 (Bottom)	$f_y =$	60.0 ksi	68.00 °F
Layer 2 (Top)	$f_y =$	60.0 ksi	68.00 °F

Modulus of Elasticity

Layer 1 (Bottom)	E =	29000.0 ksi
Layer 2 (Top)	E =	29000.0 ksi

Layer 1 (Bottom)

Area of steel at midspan (effective flange)	$A_{sm} =$	2.79 in <sup>2</sup>
Area of steel at endspan (effective flange)	$A_{se} =$	2.48 in <sup>2</sup>
Area of temperature and shrinkage steel (12" width)	$A_s =$	0.31 in <sup>2</sup>

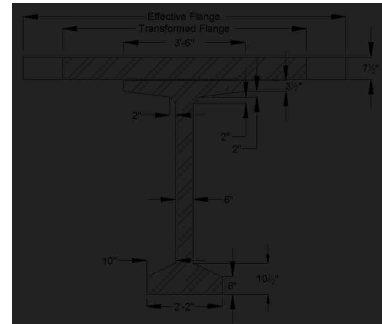
Layer 2 (Top)

Area of steel at midspan (effective flange)	$A_{sm} =$	12.6 in <sup>2</sup>
Area of steel at endspan (effective flange)	$A_{se} =$	12.4 in <sup>2</sup>
Area of temperature and shrinkage steel (12" width)	$A_s =$	0.2 in <sup>2</sup>

#### Cross-sectional Properties

##### NON-COMPOSITE BEAM

Area of cross-section of beam	A =	767.0 in <sup>2</sup>
Overall depth of beam	H =	72.0 in
Moment of Inertia	I =	539,947 in <sup>4</sup>
Distance from centroid to extreme bottom fiber	$y_b =$	36.6 in
Distance from centroid to extreme top fiber	$y_t =$	35.4 in
Section modulus for the extreme bottom fiber	$S_b =$	14915.0 in <sup>3</sup>
Section modulus for the extreme top fiber	$S_t =$	15421.0 in <sup>3</sup>
Weight	$W_t =$	799.0 plf
Modulus of Elasticity = $33000 \cdot (W_c^{1.5}) \cdot (\sqrt{f_c})$		
cast-in-place concrete deck	$E_{cs} =$	3834 ksi
precast beam at release	$E_{ci} =$	4496 ksi
precast beam at service loads	$E_c =$	5072 ksi



### COMPOSITE BEAM AT MIDSPAN

Effective Flange Width	$b_f =$	111.0 in	*min of three criteria
Modular Ratio = $E_{cs}/E_c$	$n =$	0.7559	
Transformed flange width	$=$	83.9 in	
Transformed flange area	$=$	629.3 in <sup>2</sup>	
Transformed haunch width	$=$	31.7 in	
Transformed haunch area	$=$	15.9 in <sup>2</sup>	
Deck-distance to top fiber	$y_t =$	3.75 in	

	Transformed Area	$y_b$	$Ay_b$	$A(y_{bc}-y_b)^2$	I	$I + A(y_{bc}-y_b)^2$
Beam	767.0 in <sup>2</sup>	36.60 in	28,072.2 in <sup>3</sup>	250,443 in <sup>4</sup>	539,947 in <sup>4</sup>	790,390 in <sup>4</sup>
Haunch	15.9 in <sup>2</sup>	72.25 in	1,146.9 in <sup>3</sup>	4,906 in <sup>4</sup>	0.33 in <sup>4</sup>	4,906 in <sup>4</sup>
Deck	629.3 in <sup>2</sup>	76.25 in	47,985.0 in <sup>3</sup>	293,069 in <sup>4</sup>	2,950 in <sup>4</sup>	296,019 in <sup>4</sup>
Total	1412.2 in <sup>2</sup>		77,204.1 in <sup>3</sup>			1,091,316 in <sup>4</sup>

Total area of Composite Section	$A_c =$	1412 in <sup>2</sup>
Overall Depth of the Composite Section	$h_c =$	80 in
Moment of Inertia	$I_c =$	1,091,316 in <sup>4</sup>
Distance from centroid to extreme <u>bottom</u> fiber of beam	$y_{bc} =$	54.67 in
Distance from centroid to extreme <u>top</u> fiber of beam	$y_{tg} =$	17.33 in
Distance from centroid to extreme <u>top</u> fiber of slab	$y_{tc} =$	25.33 in
Section modulus for the extreme <u>bottom</u> fiber of beam	$S_{bc} =$	19,961.9 in <sup>3</sup>
Section modulus for the extreme <u>top</u> fiber of beam	$S_{tg} =$	62,972.4 in <sup>3</sup>
Section modulus for the extreme <u>top</u> fiber slab	$S_{tc} =$	56,994.5 in <sup>3</sup>

### COMPOSITE BEAM AT ENDSPAN

Effective Flange Width	$b_f =$	106.6 in	*min of three criteria
Modular Ratio = $E_{cs}/E_c$	$n =$	0.7559	
Transformed flange width	$=$	80.6 in	
Transformed flange area	$=$	604.4 in <sup>2</sup>	
Transformed haunch width	$=$	31.7 in	
Transformed haunch area	$=$	15.9 in <sup>2</sup>	
Deck-distance to top fiber	$y_{td} =$	3.75 in	

	Transformed Area	$y_t$	$Ay_t$	$A(y_{tc}-y_t)^2$	I	$I + A(y_{tc}-y_t)^2$
Beam	767.0 in <sup>2</sup>	36.60 in	28,072.2 in <sup>3</sup>	273,455 in <sup>4</sup>	539,947 in <sup>4</sup>	813,402 in <sup>4</sup>
Haunch	15.9 in <sup>2</sup>	72.25 in	1,146.9 in <sup>3</sup>	5,660 in <sup>4</sup>	0.33 in <sup>4</sup>	5,660 in <sup>4</sup>
Deck	604.4 in <sup>2</sup>	76.25 in	46,082.8 in <sup>3</sup>	215,472 in <sup>4</sup>	2,833 in <sup>4</sup>	218,305 in <sup>4</sup>
Total	1387.2 in <sup>2</sup>		75,302.0 in <sup>3</sup>			1,037,366 in <sup>4</sup>

Total area of Composite Section	$A_c =$	1387 in <sup>2</sup>
Overall Depth of the Composite Section	$h_c =$	80 in
Moment of Inertia	$I_c =$	1,037,366 in <sup>4</sup>
Distance from centroid to extreme <u>bottom</u> fiber of beam	$y_{bc} =$	54.28 in
Distance from centroid to extreme <u>top</u> fiber of beam	$y_{tg} =$	17.72 in
Distance from centroid to extreme <u>top</u> fiber of slab	$y_{tc} =$	25.72 in
Section modulus for the extreme <u>bottom</u> fiber of beam	$S_{bc} =$	19,110.7 in <sup>3</sup>
Section modulus for the extreme <u>top</u> fiber of beam	$S_{tg} =$	58,548.3 in <sup>3</sup>
Section modulus for the extreme <u>top</u> fiber slab	$S_{tc} =$	40,336.0 in <sup>3</sup>

### Shear Forces and Bending Moments

#### DEAD LOADS

Beam self-weight	$W_{beam} =$	0.799 k/f
8 in. deck weight	$W_{deck} =$	1.200 k/f
1/2 in. haunch weight	$W_{haunch} =$	0.022 k/f

#### LRFD Specifications: Art. 4.6.2.2.1

Width of Deck Constant		OK
Number of beams is not less than four $N_b =$	4	OK
Roadway part of the overhang, $d_s \leq 3.0$ ft, $d_s =$	1.5	OK
Curvature in plans is less than 4° =	0	OK
Cross-section of the bridge is consistent with one of the cross sections given by LRFD specs		OK

Barrier and wearing surface loads are equally distributed among the 4 beams

Barrier Wt	$W_t =$	0.150 k/f
Dead load of future wearing surface	$DW =$	0.263 k/f

**LIVE LOADS**

Fire truck live load front load (Point A)	$P_{live} =$	48.0 kips
Fire truck live load back load (Point B)	$P_{live} =$	22.0 kips
distance between two loads		19.2 ft
distance from nearest edge to point A	$x_a =$	59.0 ft
distance from nearest edge to point B	$x_b =$	39.8 ft
LRFD Specifications: Art. 4.6.2.2.1		
Width of Deck Constant		OK
Number of beams is not less than four $N_b =$	4	OK
Beams are parallel and approximately of the same stiffness		OK
Roadway part of the overhang, $d_s \leq 3.0$ ft, $d_e =$	1.5	OK
Curvature in plans is less than $4^\circ =$	0	OK

Barrier and wearing surface loads are equally distributed among the 4 beams

Bridge Type-- "k" (LRFD Table 4.6.2.2.1-1)

Number of design lanes = $w/12$	=	3 lanes
---------------------------------	---	---------

**Distribution Factor for Bending Moment:**

Beams spacing	$S =$	12.0 ft
Depth of concrete slab	$t_s =$	7.5 in
Beam Span	$L =$	120.0 ft
Number of Beams	$N_b =$	4
Modular ratio between beam & deck materials	$n =$	1.3229
Longitudinal stiffness parameter	$K_g =$	2,309,429.79 in <sup>4</sup>

at center span:

$$DFM = 0.75 \left[ \left( \frac{S}{3.5} \right)^{0.1} + \left( \frac{S}{L} \right)^{0.2} + \left( \frac{K_g}{12 * L * t_s^3} \right)^{0.1} \right]$$

DFM =	0.905 lanes/beam
-------	------------------

0.905 Controls

one design lane loaded:

$$DFM = 0.75 + \left( \frac{S}{4} \right)^{0.4} + \left( \frac{S}{L} \right)^{0.3} + \left( \frac{K_g}{2 * L * t_s^3} \right)^{0.1}$$

DFM =	0.614 lanes/beam
-------	------------------

**Distribution Factor for Shear Force**

both end spans and center span:

$$DFV = 0.2 + \left( \frac{S}{12} \right) + \left( \frac{S}{35} \right)^2$$

DFV =	1.082 lanes/beam
-------	------------------

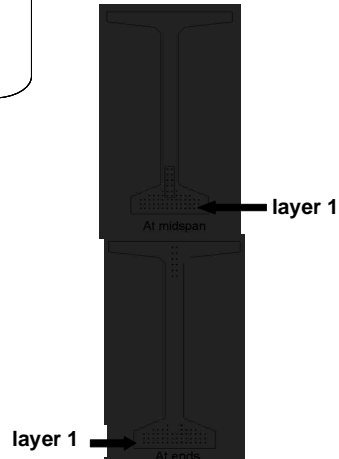
1.082 Controls

one design lane loaded:

$$DFV = 0.36 + \left( \frac{S}{25} \right)$$

DFV =	0.840 lanes/beam
-------	------------------

from bottom	At Midspan		At Ends	
	No. of	Distance from Bottom	No. of	Distance from Bottom
layer 1	14	2	14	2
layer 2	14	3.5	14	3.5
layer 3	14	5	14	5
layer 4	10	6.5	8	6.5
layer 5	4	8	2	8
layer 6	2	10	-	-
layer 7	2	12	-	-
layer 8	2	14	-	-
layer 9	2	16	2	60
layer 10	-	-	2	62
layer 11	-	-	2	64
layer 12	-	-	2	66
layer 13	-	-	2	68
layer 14	-	-	2	70
	64		64	
<b>Harped Strand Group (included in above totals)</b>				
layer 3	2	6		
layer 4	2	8		
layer 5	2	10		
layer 6	2	12		
layer 7	2	14		
layer 8	2	16		



distance from the center of gravity of strands to the bottom fiber of the beam = 7% of the beam depth  
strand eccentricity at midspan =  $(y_c - y_{bs})$

$y_{bs} =$	5.44 in
$e_c =$	31.16 in

### Prestress Losses

#### ELASTIC SHORTENING

assumed loss	=	6.00%
Force per strand at transfer		
layer 1	=	17.0 kips
layer 2	=	17.0 kips
layer 3	=	17.0 kips
layer 4	=	17.0 kips
layer 5	=	17.0 kips
layer 6	=	17.0 kips
layer 7	=	17.0 kips
layer 8	=	17.0 kips
layer 9	=	17.0 kips
layer 10	=	17.0 kips
layer 11	=	17.0 kips
layer 12	=	17.0 kips
layer 13	=	17.0 kips
layer 14	=	17.0 kips

Total prestressing force at release	$P_i =$	at midspan 1088.0 kips	at endspan 1054.0 kips
Sum of concrete stresses at the center of gravity of prestressing tendons due to prestressing force at transfer and the self-weight of the member at sections of maximum moment	$f_{cgp} =$	2.412 ksi	2.307 ksi
Loss due to shortening		at midspan	at endspan
layer 1	$\Delta f_{pES} =$	13.9 ksi	13.3 ksi
layer 2	$\Delta f_{pES} =$	13.9 ksi	13.3 ksi
layer 3	$\Delta f_{pES} =$	13.9 ksi	13.3 ksi
layer 4	$\Delta f_{pES} =$	13.9 ksi	13.3 ksi
layer 5	$\Delta f_{pES} =$	13.9 ksi	13.3 ksi
layer 6	$\Delta f_{pES} =$	13.9 ksi	
layer 7	$\Delta f_{pES} =$	13.9 ksi	
layer 8	$\Delta f_{pES} =$	13.9 ksi	
layer 9	$\Delta f_{pES} =$	13.9 ksi	13.3 ksi
layer 10	$\Delta f_{pES} =$		13.3 ksi
layer 11	$\Delta f_{pES} =$		13.3 ksi
layer 12	$\Delta f_{pES} =$		13.3 ksi
layer 13	$\Delta f_{pES} =$		13.3 ksi
layer 14	$\Delta f_{pES} =$		13.3 ksi

#### SHRINKAGE

Shrinkage = $(17 - 0.15 \cdot \text{Relative Humidity})$	$\Delta f_{pSR} =$	6.5 ksi	← assume relative humidity = 70%
--	--------------------	---------	----------------------------------

#### CREEP OF CONCRETE

Change of stresses at center of gravity of prestressing due to permanent loads except the loads acting at time of applying prestressing force, calculated at the same section as $f_{cgp}$	$\Delta f_{cgp} =$	1.587 ksi	
loss due to creep	$\Delta f_{pCR} =$	at midspan 17.8 ksi	at endspan 16.6 ksi

**RELAXATION OF PRESTRESSING STRANDS**

loss due to relaxation after transfer		at midspan	at endspan
layer 1	$\Delta f_{PR2} =$	2.9 ksi	2.9 ksi
layer 2	$\Delta f_{PR2} =$	2.9 ksi	2.9 ksi
layer 3	$\Delta f_{PR2} =$	2.9 ksi	2.9 ksi
layer 4	$\Delta f_{PR2} =$	2.9 ksi	2.9 ksi
layer 5	$\Delta f_{PR2} =$	2.9 ksi	2.9 ksi
layer 6	$\Delta f_{PR2} =$	2.9 ksi	
layer 7	$\Delta f_{PR2} =$	2.9 ksi	
layer 8	$\Delta f_{PR2} =$	2.9 ksi	
layer 9	$\Delta f_{PR2} =$	2.9 ksi	2.9 ksi
layer 10	$\Delta f_{PR2} =$		2.9 ksi
layer 11	$\Delta f_{PR2} =$		2.9 ksi
layer 12	$\Delta f_{PR2} =$		2.9 ksi
layer 13	$\Delta f_{PR2} =$		2.9 ksi
layer 14	$\Delta f_{PR2} =$		2.9 ksi

**TOTAL LOSSES AT TRANSFER**

total loss  $\Delta f_{pES} = \Delta f_{pl}$

stress in tendons after transfer  $f_{pt} = f_{pr} - \Delta f_{pl}$

		at midspan	at endspan
layer 1	$f_{pt} =$	199.3 ksi	199.9 ksi
layer 2	$f_{pt} =$	199.3 ksi	199.9 ksi
layer 3	$f_{pt} =$	199.3 ksi	199.9 ksi
layer 4	$f_{pt} =$	199.3 ksi	199.9 ksi
layer 5	$f_{pt} =$	199.3 ksi	199.9 ksi
layer 6	$f_{pt} =$	199.3 ksi	
layer 7	$f_{pt} =$	199.3 ksi	
layer 8	$f_{pt} =$	199.3 ksi	
layer 9	$f_{pt} =$	199.3 ksi	199.9 ksi
layer 10	$f_{pt} =$		199.9 ksi
layer 11	$f_{pt} =$		199.9 ksi
layer 12	$f_{pt} =$		199.9 ksi
layer 13	$f_{pt} =$		199.9 ksi
layer 14	$f_{pt} =$		199.9 ksi

force per strand =  $f_{pt} \cdot \text{strand area}$

		at midspan	at endspan
layer 1	=	16.9 kips	17.0 kips
layer 2	=	16.9 kips	17.0 kips
layer 3	=	16.9 kips	17.0 kips
layer 4	=	16.9 kips	17.0 kips
layer 5	=	16.9 kips	17.0 kips
layer 6	=	16.9 kips	
layer 7	=	16.9 kips	
layer 8	=	16.9 kips	
layer 9	=	16.9 kips	17.0 kips
layer 10	=		17.0 kips
layer 11	=		17.0 kips
layer 12	=		17.0 kips
layer 13	=		17.0 kips
layer 14	=		17.0 kips

Total prestressing force after transfer

Initial loss =  $(\Delta f_{pl}) / (f_{pr})$

		at midspan	at endspan
layer 1	% =	6.5%	6.2%
layer 2	% =	6.5%	6.2%
layer 3	% =	6.5%	6.2%
layer 4	% =	6.5%	6.2%
layer 5	% =	6.5%	6.2%
layer 6	% =	6.5%	
layer 7	% =	6.5%	
layer 8	% =	6.5%	
layer 9	% =	6.5%	6.2%
layer 10	% =		6.2%
layer 11	% =		6.2%
layer 12	% =		6.2%
layer 13	% =		6.2%
layer 14	% =		6.2%

OK  
OK  
OK  
OK  
OK  
OK  
OK  
OK  
OK  
OK  
OK  
OK  
OK  
OK



**TOTAL LOSSES AT SERVICE LOADS**

Total Losses		at midspan	at endspan
layer 1	$\Delta f_{pT} =$	41.1 ksi	40.5 ksi
layer 2	$\Delta f_{pT} =$	41.1 ksi	40.5 ksi
layer 3	$\Delta f_{pT} =$	41.1 ksi	40.5 ksi
layer 4	$\Delta f_{pT} =$	41.1 ksi	40.5 ksi
layer 5	$\Delta f_{pT} =$	41.1 ksi	40.5 ksi
layer 6	$\Delta f_{pT} =$	41.1 ksi	
layer 7	$\Delta f_{pT} =$	41.1 ksi	
layer 8	$\Delta f_{pT} =$	41.1 ksi	
layer 9	$\Delta f_{pT} =$	41.1 ksi	40.5 ksi
layer 10	$\Delta f_{pT} =$		40.5 ksi
layer 11	$\Delta f_{pT} =$		40.5 ksi
layer 12	$\Delta f_{pT} =$		40.5 ksi
layer 13	$\Delta f_{pT} =$		40.5 ksi
layer 14	$\Delta f_{pT} =$		40.5 ksi

Stress in tendon after all losses = $f_{pi} - \Delta f_{pi}$		at midspan	at endspan
layer 1	$f_{pe} =$	172.0 ksi	172.7 ksi
layer 2	$f_{pe} =$	172.0 ksi	172.7 ksi
layer 3	$f_{pe} =$	172.0 ksi	172.7 ksi
layer 4	$f_{pe} =$	172.0 ksi	172.7 ksi
layer 5	$f_{pe} =$	172.0 ksi	172.7 ksi
layer 6	$f_{pe} =$	172.0 ksi	
layer 7	$f_{pe} =$	172.0 ksi	
layer 8	$f_{pe} =$	172.0 ksi	
layer 9	$f_{pe} =$	172.0 ksi	172.7 ksi
layer 10	$f_{pe} =$		172.7 ksi
layer 11	$f_{pe} =$		172.7 ksi
layer 12	$f_{pe} =$		172.7 ksi
layer 13	$f_{pe} =$		172.7 ksi
layer 14	$f_{pe} =$		172.7 ksi

check prestressing stress limit at service limit state:  $f_{pe} \leq 0.8 \cdot f_{py}$

layer 1	=	205.4 ksi
layer 2	=	205.4 ksi
layer 3	=	205.4 ksi
layer 4	=	205.4 ksi
layer 5	=	205.4 ksi
layer 6	=	205.4 ksi
layer 7	=	205.4 ksi
layer 8	=	205.4 ksi
layer 9	=	205.4 ksi
layer 10	=	205.4 ksi
layer 11	=	205.4 ksi
layer 12	=	205.4 ksi
layer 13	=	205.4 ksi
layer 14	=	205.4 ksi

OK  
OK  
OK  
OK  
OK  
OK  
OK  
OK  
OK  
OK  
OK  
OK  
OK  
OK

force per strand =  $f_{pe} \cdot \text{strand area}$

		at midspan	at endspan
layer 1	=	14.6 kips	14.7 kips
layer 2	=	14.6 kips	14.7 kips
layer 3	=	14.6 kips	14.7 kips
layer 4	=	14.6 kips	14.7 kips
layer 5	=	14.6 kips	14.7 kips
layer 6	=	14.6 kips	
layer 7	=	14.6 kips	
layer 8	=	14.6 kips	
layer 9	=	14.6 kips	14.7 kips
layer 10	=		14.7 kips
layer 11	=		14.7 kips
layer 12	=		14.7 kips
layer 13	=		14.7 kips
layer 14	=		14.7 kips

		at midspan	at endspan
Total prestressing force after all losses	$P_{pe} =$	935.9 kips	939.2 kips
Final losses, % = $(\Delta f_{pT})/f_{pi}$			
layer 1	% =	19.3%	19.0%
layer 2	% =	19.3%	19.0%
layer 3	% =	19.3%	19.0%
layer 4	% =	19.3%	19.0%
layer 5	% =	19.3%	19.0%
layer 6	% =	19.3%	
layer 7	% =	19.3%	
layer 8	% =	19.3%	
layer 9	% =	19.3%	19.0%
layer 10	% =		19.0%
layer 11	% =		19.0%
layer 12	% =		19.0%
layer 13	% =		19.0%
layer 14	% =		19.0%
Average final losses, %	% =	19.3%	19.0%

### Stresses at Transfer

#### STRESS LIMITS FOR CONCRETE

Compression = $0.6f'_{ci}$	$f_{ci} =$	3.300 ksi
Tension		
without bonded reinforcement = $-0.0948\sqrt{f'_{ci}} \leq -0.2$	$=$	-0.200 ksi
with bonded auxiliary reinforcement = $-0.22\sqrt{f'_{ci}}$	$=$	-0.016 ksi

#### STRESSES AT TRANSFER LENGTH SECTION

Transfer Length = $60 \times (\text{strand diameter})$	$=$	1.9 ft	} Calcs for eccentricity (see 9.6.7.2)
Bending moment at transfer length	$M_g =$	87.7 ft-kips	
center of 12 strands to top fiber of beam at the end	$=$	7.00 in	
center of 12 strands to bottom fiber of beam at the harp point	$=$	11.00 in	
center of 12 strands and top fiber of beam at transfer length	$=$	9.84 in	
center of gravity of 32 strands and bottom fiber of beam	$=$	3.98 in	
center of gravity of all strands and the bottom fiber of beam at transfer length	$=$	15.24 in	
center of gravity of all strands and the bottom fiber of beam at the end	$=$	15.30 in	
Eccentricity of the strand group at transfer length:	$e_h =$	21.36 in	}
Eccentricity at end of beam:	$e =$	21.30 in	

$$f_t = \frac{P_i}{A} - \frac{P_i e}{S_t} + \frac{M_g}{S_t}$$

$$f_b = \frac{P_i}{A} + \frac{P_i e}{S_b} - \frac{M_g}{S_b}$$

		at midspan	at endspan	
Top stress at top fiber of beam	$f_t =$	-0.017 ksi	-0.017 ksi	OK
Bottom stress at bottom fiber of the beam	$f_b =$	2.906 ksi	2.906 ksi	OK

#### STRESSES AT HARP POINT

Bending moment due to beam weight at 0.3L	$M_g =$	1188.0 ft-kips		
Top stress at top fiber of beam	$f_t =$	0.173 ksi	0.169 ksi	OK
Bottom stress at bottom fiber of the beam	$f_b =$	2.736 ksi	2.621 ksi	OK

#### STRESSES AT MIDSPAN

Bending moment due to beam weight at 0.5L	$M_g =$	1414.3 ft-kips		
Top stress at top fiber of beam	$f_t =$	0.320 ksi	0.345 ksi	OK
Bottom stress at bottom fiber of the beam	$f_b =$	2.554 ksi	2.438 ksi	OK

#### HOLD-DOWN FORCES

assume stress in strand before losses =  $0.8f_u$

layer 1	$=$	227.4 ksi
layer 2	$=$	227.4 ksi
layer 3	$=$	227.4 ksi
layer 4	$=$	227.4 ksi
layer 5	$=$	227.4 ksi
layer 6	$=$	227.4 ksi
layer 7	$=$	227.4 ksi
layer 8	$=$	227.4 ksi
layer 9	$=$	227.4 ksi
layer 10	$=$	227.4 ksi
layer 11	$=$	227.4 ksi
layer 12	$=$	227.4 ksi
layer 13	$=$	227.4 ksi
layer 14	$=$	227.4 ksi

prestress force per strand before any losses:

layer 1	=	19.3 kips
layer 2	=	19.3 kips
layer 3	=	19.3 kips
layer 4	=	19.3 kips
layer 5	=	19.3 kips
layer 6	=	19.3 kips
layer 7	=	19.3 kips
layer 8	=	19.3 kips
layer 9	=	19.3 kips
layer 10	=	19.3 kips
layer 11	=	19.3 kips
layer 12	=	19.3 kips
layer 13	=	19.3 kips
layer 14	=	19.3 kips
Harp Angle	$\psi$ =	7.2 °

Hold-down force/strand

layer 1	=	2.5 kips/strand
layer 2	=	2.5 kips/strand
layer 3	=	2.5 kips/strand
layer 4	=	2.5 kips/strand
layer 5	=	2.5 kips/strand
layer 6	=	2.5 kips/strand
layer 7	=	2.5 kips/strand
layer 8	=	2.5 kips/strand
layer 9	=	2.5 kips/strand
layer 10	=	2.5 kips/strand
layer 11	=	2.5 kips/strand
layer 12	=	2.5 kips/strand
layer 13	=	2.5 kips/strand
layer 14	=	2.5 kips/strand
Total hold-down force	=	30.45 kips

### Stresses at Service Loads

#### STRESS LIMITS FOR CONCRETE

Compression:

Due to permanent loads for load combination Service I

for the precast beam	=	3.150 ksi
for deck	=	1.800 ksi

Due to permanent and transient loads for load combination Service I

for the precast beam	=	4.200 ksi
for deck	=	2.400 ksi

Tension:

Load Combination Service III

for the precast beam	=	-0.016 ksi
----------------------	---	------------

#### STRESSES AT MIDSPAN

Compression stresses at top fiber of beam	at midspan	at endspan		
$f_1 = \frac{P_{pe}}{A} - \frac{P_{pe}e}{S_1} + \frac{(M_w + M_d)}{S_t} + \frac{(M_w + M_b)}{S_{tg}}$	$f_{1g} =$	2.105 ksi	2.102 ksi	OK
Due to permanent loads				
$f_{1g} = \frac{P_M}{A} - \frac{P_{pe}e}{S_1} + \frac{(M_w + M_d)}{S_t} + \frac{(M_w - M_b)}{S_{tg}} + \frac{(M_{LL+I})}{S_{tg}}$	$f_{1g} =$	2.508 ksi	2.505 ksi	OK
Due to permanent loads and transient loads				
<b>Compression stresses at top fiber of deck</b>	<b>at midspan</b>	<b>at endspan</b>		
$f_{1g} = \frac{(M_w + M_b)}{S_{tc}}$	$f_{1g} =$	0.042 ksi	0.042 ksi	OK
Due to permanent loads				
$f_{1g} = \frac{(M_w + M_b + M_{LL+I})}{S_{tc}}$	$f_{1g} =$	0.488 ksi	0.488 ksi	OK
Due to permanent loads and transient loads				
<b>Tension stresses at top fiber of deck</b>	<b>at midspan</b>	<b>at endspan</b>		
$f_{1g} = \frac{P_{pe}}{A} + \frac{P_{pe}e}{S_b} - \frac{(M_w + M_d)}{S_b} - \frac{(M_w + M_b + 0.5 * M_{LL+I})}{S_{br}}$	$f_{1g} =$	-0.792 ksi	-0.781 ksi	OK
Load Combination Service III				

**Strength Limit State**

POSITIVE MOMENT SECTION		
$M_u = 1.25DC+1.5DW+1.75(LL+IM)$	$M_u =$	8381.5 ft-kips
effective length factor for compression members		
layer 1	k =	0.27
layer 2	k =	0.27
layer 3	k =	0.27
layer 4	k =	0.27
layer 5	k =	0.27
layer 6	k =	0.27
layer 7	k =	0.27
layer 8	k =	0.27
layer 9	k =	0.27
layer 10	k =	0.27
layer 11	k =	0.27
layer 12	k =	0.27
layer 13	k =	0.27
layer 14	k =	0.27
	c =	4.6 ft-kips
average stress in prestressing steel		
layer 1	$f_{ps} =$	279.4 ksi
layer 2	$f_{ps} =$	279.4 ksi
layer 3	$f_{ps} =$	279.4 ksi
layer 4	$f_{ps} =$	279.4 ksi
layer 5	$f_{ps} =$	279.4 ksi
layer 6	$f_{ps} =$	279.4 ksi
layer 7	$f_{ps} =$	279.4 ksi
layer 8	$f_{ps} =$	279.4 ksi
layer 9	$f_{ps} =$	279.4 ksi
layer 10	$f_{ps} =$	279.4 ksi
layer 11	$f_{ps} =$	279.4 ksi
layer 12	$f_{ps} =$	279.4 ksi
layer 13	$f_{ps} =$	279.4 ksi
layer 14	$f_{ps} =$	279.4 ksi
nominal flexure resistance		
	a =	3.92 in
$M_r = \Phi M_n, \Phi = 1.00$	$\Phi M_n =$	9196.5 ft-kips
M=DC+W+LL+IM	M =	5833.6 ft-kips
NEGATIVE MOMENT SECTION		
$M_u = 1.25DC+1.5DW+1.75(LL+IM)$	$M_u =$	-4837.2 ft-kips
	a =	5.97 in
	$\Phi M_n =$	4905.9 ft-kips
M=DC+W+LL+IM	M =	-2869.7 ft-kips

OK  
OK

OK  
OK

### Shear Design

CRITICAL SECTION AT 0.59		
$V_u = 1.25DC + 1.5DW + 1.75(LL + IM)$	$V_u =$	405.0 kips
$M_u = 1.25DC + 1.5DW + 1.75(LL + IM)$	$M_u =$	-2684.4 ft-kips
or		
$V_u = 1.25DC + 1.5DW + 1.75(LL + IM)$	$V_u =$	364.8 kips
$M_u = 1.25DC + 1.5DW + 1.75(LL + IM)$	$M_u =$	-2877.0 ft-kips
max shear	$V_u =$	405.0 kips
max moment	$M_u =$	2877.0 ft-kips
Shear depth	$d_v =$	73.19 in
Applied factored normal force at the section	$N_u =$	0
Angle of diagonal compressive stresses	$\theta =$	36.00 °

### STRAIN IN FLEXURAL TENSION REINFORCEMENT

$$\epsilon_s = \frac{\frac{M_u}{d_v} + 0.5N_u \cot \theta + A_{ps} f_{ps}}{E_s A_s + E_p A_{ps}} \leq 0.002$$

	at midspan	at endspan
resultant compressive stress at centroid	$f_{pc} =$ 0.909 ksi	0.911 ksi

effective stress in prestressing strand after all losses

	at midspan	at endspan
layer 1	$f_{po} =$ 176.7 ksi	177.3 ksi
layer 2	$f_{po} =$ 176.7 ksi	177.3 ksi
layer 3	$f_{po} =$ 176.7 ksi	177.3 ksi
layer 4	$f_{po} =$ 176.7 ksi	177.3 ksi
layer 5	$f_{po} =$ 176.7 ksi	
layer 6	$f_{po} =$ 176.7 ksi	
layer 7	$f_{po} =$ 176.7 ksi	
layer 8	$f_{po} =$ 176.7 ksi	
layer 9	$f_{po} =$	177.3 ksi
layer 10	$f_{po} =$	177.3 ksi
layer 11	$f_{po} =$	177.3 ksi
layer 12	$f_{po} =$	177.3 ksi
layer 13	$f_{po} =$	177.3 ksi
layer 14	$f_{po} =$	177.3 ksi

strain in flexural tension

	at midspan	at endspan
layer 1	$\epsilon_x =$ 0.002000	0.002000
layer 2	$\epsilon_x =$ 0.002000	0.002000
layer 3	$\epsilon_x =$ 0.002000	0.002000
layer 4	$\epsilon_x =$ 0.002000	0.002000
layer 5	$\epsilon_x =$ 0.002000	
layer 6	$\epsilon_x =$ 0.002000	
layer 7	$\epsilon_x =$ 0.002000	
layer 8	$\epsilon_x =$ 0.002000	
layer 9	$\epsilon_x =$	0.002000
layer 10	$\epsilon_x =$	0.002000
layer 11	$\epsilon_x =$	0.002000
layer 12	$\epsilon_x =$	0.002000
layer 13	$\epsilon_x =$	0.002000
layer 14	$\epsilon_x =$	0.002000

### Deflection and Camber

	at midspan	at endspan
Deflection due to Prestressing Force at Transfer	$\Delta_p =$ 3.27 in	3.29 in
Deflection due to Beam Self-Weight at Transfer	$\Delta_{g1} =$ -1.49 in	
Deflection due to Beam Self-Weight at Erection	$\Delta_{g2} =$ -1.44 in	
Deflection due to Haunch and Deck	$\Delta_s =$ -1.95 in	

Deflection due to total self weight

$\Delta_{sw} =$ -0.11 in
--------------------------

Total Deflection at transfer

$\Delta =$ 1.79 in	1.81 in
--------------------	---------

Total Deflection at erection

$\Delta =$ 3.24 in	3.27 in
--------------------	---------

Live load deflection limit = span/800

$=$ 1.80 in
-------------

Deflection due to live load and impact

$\Delta_L =$ -0.83 in
-----------------------

OK

Deflection due to fire truck

$\Delta_L =$ -0.7520 in
-------------------------

OK

Total Deflection after fire with fire truck

$\Delta =$ 2.4129 in
----------------------

**Location: Fire at Critical Negative Moment Sections**  
**Beam Design: 3/8" Strand**  
**Fire Exposure Status: 1/2 Hour**

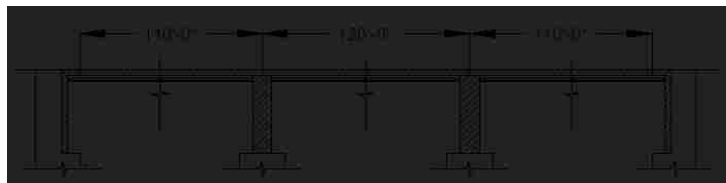
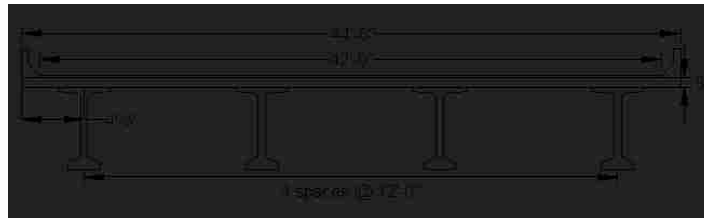
(PCI Bridge Design Manual Section 9.6)



**Material Properties**

CAST-IN-PLACE SLAB		
Actual Thickness	$t_{as} =$	8.0 in
Wearing Surface	$=$	0.5 in
Structural thickness = Actual - Wearing Surface	$t_s =$	7.5 in
Compressive Strength	$f'_c =$	3.74 ksi
Unit Weight	$w_c =$	150.0 pcf
Stress factor of compression block	$\beta_1 =$	0.85

BEAMS: AASHTO-PCI, BT-72 BULB-TEE		
Strength at release	$f'_{ci} =$	5.5 ksi
Strength at 28 days	$f'_c =$	7 ksi
Unit Weight	$w_c =$	150.0 pcf
Overall Beam Length:		
@ end spans	$L =$	110 ft
@ center span	$L =$	119 ft
Design Spans:		
Non-composite beam @ end spans	$L =$	109 ft
Non-composite beam @ center span	$L =$	118 ft
Composite beam @ end spans	$L =$	110 ft
Composite beam @ center span	$L =$	120 ft
Beam Spacing	$S =$	12 ft



**PRESTRESSING STRANDS**

Diameter of single strand	d =	0.4 in
Area of single strand	A =	0.085 in <sup>2</sup>
<b>Temperature of Layer</b>		
layer 1 (bottom)	T =	68.00 °F
layer 2	T =	68.00 °F
layer 3	T =	68.00 °F
layer 4	T =	68.00 °F
layer 5	T =	68.00 °F
layer 6	T =	68.00 °F
layer 7	T =	68.00 °F
layer 8	T =	68.00 °F
layer 9	T =	68.00 °F
layer 10	T =	68.00 °F
layer 11	T =	68.00 °F
layer 12	T =	68.00 °F
layer 13	T =	68.00 °F
layer 14	T =	68.00 °F
<b>Ultimate Strength</b>		
initial = 284 ksi		
layer 1 (bottom)	f <sub>pu</sub> =	284 ksi
layer 2	f <sub>pu</sub> =	284 ksi
layer 3	f <sub>pu</sub> =	284 ksi
layer 4	f <sub>pu</sub> =	284 ksi
layer 5	f <sub>pu</sub> =	284 ksi
layer 6	f <sub>pu</sub> =	284 ksi
layer 7	f <sub>pu</sub> =	284 ksi
layer 8	f <sub>pu</sub> =	284 ksi
layer 9	f <sub>pu</sub> =	284 ksi
layer 10	f <sub>pu</sub> =	284 ksi
layer 11	f <sub>pu</sub> =	284 ksi
layer 12	f <sub>pu</sub> =	284 ksi
layer 13	f <sub>pu</sub> =	284 ksi
layer 14	f <sub>pu</sub> =	284 ksi
<b>Yield Strength</b>		
initial = 257 ksi		
layer 1 (bottom)	f <sub>py</sub> =	257 ksi
layer 2	f <sub>py</sub> =	257 ksi
layer 3	f <sub>py</sub> =	257 ksi
layer 4	f <sub>py</sub> =	257 ksi
layer 5	f <sub>py</sub> =	257 ksi
layer 6	f <sub>py</sub> =	257 ksi
layer 7	f <sub>py</sub> =	257 ksi
layer 8	f <sub>py</sub> =	257 ksi
layer 9	f <sub>py</sub> =	257 ksi
layer 10	f <sub>py</sub> =	257 ksi
layer 11	f <sub>py</sub> =	257 ksi
layer 12	f <sub>py</sub> =	257 ksi
layer 13	f <sub>py</sub> =	257 ksi
layer 14	f <sub>py</sub> =	257 ksi
<b>Stress Limits:</b>		
before transfer ≤ 0.75f <sub>pu</sub> (initial = 213.2)		
layer 1 (bottom)	f <sub>pl</sub> =	213.2 ksi
layer 2	f <sub>pl</sub> =	213.2 ksi
layer 3	f <sub>pl</sub> =	213.2 ksi
layer 4	f <sub>pl</sub> =	213.2 ksi
layer 5	f <sub>pl</sub> =	213.2 ksi
layer 6	f <sub>pl</sub> =	213.2 ksi
layer 7	f <sub>pl</sub> =	213.2 ksi
layer 8	f <sub>pl</sub> =	213.2 ksi
layer 9	f <sub>pl</sub> =	213.2 ksi
layer 10	f <sub>pl</sub> =	213.2 ksi
layer 11	f <sub>pl</sub> =	213.2 ksi
layer 12	f <sub>pl</sub> =	213.2 ksi
layer 13	f <sub>pl</sub> =	213.2 ksi
layer 14	f <sub>pl</sub> =	213.2 ksi

at service limit state (after all losses)  $\leq 0.80f_{py}$  (initial = 205.4)

layer 1 (bottom)	$f_{ps} =$	205.4 ksi
layer 2	$f_{ps} =$	205.4 ksi
layer 3	$f_{ps} =$	205.4 ksi
layer 4	$f_{ps} =$	205.4 ksi
layer 5	$f_{ps} =$	205.4 ksi
layer 6	$f_{ps} =$	205.4 ksi
layer 7	$f_{ps} =$	205.4 ksi
layer 8	$f_{ps} =$	205.4 ksi
layer 9	$f_{ps} =$	205.4 ksi
layer 10	$f_{ps} =$	205.4 ksi
layer 11	$f_{ps} =$	205.4 ksi
layer 12	$f_{ps} =$	205.4 ksi
layer 13	$f_{ps} =$	205.4 ksi
layer 14	$f_{ps} =$	205.4 ksi

Modulus of Elasticity

initial = 25898 ksi

layer 1 (bottom)	E =	25898.0 ksi
layer 2	E =	25898.0 ksi
layer 3	E =	25898.0 ksi
layer 4	E =	25898.0 ksi
layer 5	E =	25898.0 ksi
layer 6	E =	25898.0 ksi
layer 7	E =	25898.0 ksi
layer 8	E =	25898.0 ksi
layer 9	E =	25898.0 ksi
layer 10	E =	25898.0 ksi
layer 11	E =	25898.0 ksi
layer 12	E =	25898.0 ksi
layer 13	E =	25898.0 ksi
layer 14	E =	25898.0 ksi

#### MILD STEEL REINFORCING BARS

Yield Strength

Layer 1 (Bottom)	$f_y =$	60.0 ksi	68.00 °F
Layer 2 (Top)	$f_y =$	58.2 ksi	550.00 °F

Modulus of Elasticity

Layer 1 (Bottom)	E =	29000.0 ksi
Layer 2 (Top)	E =	29000.0 ksi

Layer 1 (Bottom)

Area of steel at midspan (effective flange)	$A_{sm} =$	2.79 in <sup>2</sup>
Area of steel at endspan (effective flange)	$A_{se} =$	2.48 in <sup>2</sup>
Area of temperature and shrinkage steel (12" width)	$A_{st} =$	0.31 in <sup>2</sup>

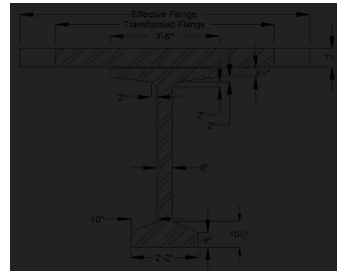
Layer 2 (Top)

Area of steel at midspan (effective flange)	$A_{sm} =$	12.6 in <sup>2</sup>
Area of steel at endspan (effective flange)	$A_{se} =$	12.4 in <sup>2</sup>
Area of temperature and shrinkage steel (12" width)	$A_{st} =$	0.2 in <sup>2</sup>

#### Cross-sectional Properties

##### NON-COMPOSITE BEAM

Area of cross-section of beam	A =	767.0 in <sup>2</sup>
Overall depth of beam	H =	72.0 in
Moment of Inertia	I =	539,947 in <sup>4</sup>
Distance from centroid to extreme <b>bottom</b> fiber	$y_b =$	36.6 in
Distance from centroid to extreme <b>top</b> fiber	$y_t =$	35.4 in
Section modulus for the extreme <b>bottom</b> fiber	$S_b =$	14915.0 in <sup>3</sup>
Section modulus for the extreme <b>top</b> fiber	$S_t =$	15421.0 in <sup>3</sup>
Weight	$W_t =$	799.0 plf
Modulus of Elasticity = $33000 \cdot (W_c \cdot 1.5)^{1/3} \cdot (\sqrt{f_c})$		
cast-in-place concrete deck	$E_{cs} =$	3708 ksi
precast beam at release	$E_{ci} =$	4496 ksi
precast beam at service loads	$E_c =$	5072 ksi





### COMPOSITE BEAM AT MIDSPAN

Effective Flange Width	$b_f =$	111.0 in	*min of three criteria
Modular Ratio = $E_{cs}/E_c$	$n =$	0.7309	
Transformed flange width	$=$	81.1 in	
Transformed flange area	$=$	608.5 in <sup>2</sup>	
Transformed haunch width	$=$	30.7 in	
Transformed haunch area	$=$	15.3 in <sup>2</sup>	
Deck-distance to top fiber	$y_t =$	4.56 in	

	Transformed Area	$y_b$	$Ay_b$	$A(y_{bc}-y_b)^2$	$I$	$I + A(y_{bc}-y_b)^2$
Beam	767.0 in <sup>2</sup>	36.60 in	28,072.2 in <sup>3</sup>	231,850 in <sup>4</sup>	539,947 in <sup>4</sup>	771,797 in <sup>4</sup>
Haunch	15.3 in <sup>2</sup>	72.25 in	1,109.0 in <sup>3</sup>	5,120 in <sup>4</sup>	0.32 in <sup>4</sup>	5,121 in <sup>4</sup>
Deck	608.5 in <sup>2</sup>	75.44 in	45,906.3 in <sup>3</sup>	280,077 in <sup>4</sup>	2,268 in <sup>4</sup>	282,345 in <sup>4</sup>
Total	1390.9 in <sup>2</sup>		75,087.6 in <sup>3</sup>			1,059,263 in <sup>4</sup>

Total area of Composite Section	$A_c =$	1391 in <sup>2</sup>
Overall Depth of the Composite Section	$h_c =$	80 in
Moment of Inertia	$I_c =$	1,059,263 in <sup>4</sup>
Distance from centroid to extreme <u>bottom</u> fiber of beam	$y_{bc} =$	53.99 in
Distance from centroid to extreme <u>top</u> fiber of beam	$y_{tg} =$	18.01 in
Distance from centroid to extreme <u>top</u> fiber of slab	$y_{tc} =$	26.01 in
Section modulus for the extreme <u>bottom</u> fiber of beam	$S_{bc} =$	19,621.0 in <sup>3</sup>
Section modulus for the extreme <u>top</u> fiber of beam	$S_{tg} =$	58,803.0 in <sup>3</sup>
Section modulus for the extreme <u>top</u> fiber slab	$S_{tc} =$	55,707.6 in <sup>3</sup>

### COMPOSITE BEAM AT ENDSpan

Effective Flange Width	$b_f =$	106.6 in	*min of three criteria
Modular Ratio = $E_{cs}/E_c$	$n =$	0.7309	
Transformed flange width	$=$	77.9 in	
Transformed flange area	$=$	584.4 in <sup>2</sup>	
Transformed haunch width	$=$	30.7 in	
Transformed haunch area	$=$	15.3 in <sup>2</sup>	
Deck-distance to top fiber	$y_{td} =$	4.56 in	

	Transformed Area	$y_t$	$Ay_t$	$A(y_{bc}-y_t)^2$	$I$	$I + A(y_{bc}-y_t)^2$
Beam	767.0 in <sup>2</sup>	36.60 in	28,072.2 in <sup>3</sup>	273,989 in <sup>4</sup>	539,947 in <sup>4</sup>	813,936 in <sup>4</sup>
Haunch	15.3 in <sup>2</sup>	72.25 in	1,109.0 in <sup>3</sup>	5,483 in <sup>4</sup>	0.32 in <sup>4</sup>	5,484 in <sup>4</sup>
Deck	584.4 in <sup>2</sup>	77.06 in	45,033.3 in <sup>3</sup>	208,758 in <sup>4</sup>	2,182 in <sup>4</sup>	210,940 in <sup>4</sup>
Total	1366.7 in <sup>2</sup>		74,214.6 in <sup>3</sup>			1,030,360 in <sup>4</sup>

Total area of Composite Section	$A_c =$	1367 in <sup>2</sup>
Overall Depth of the Composite Section	$h_c =$	80 in
Moment of Inertia	$I_c =$	1,030,360 in <sup>4</sup>
Distance from centroid to extreme <u>bottom</u> fiber of beam	$y_{bc} =$	54.30 in
Distance from centroid to extreme <u>top</u> fiber of beam	$y_{tg} =$	17.70 in
Distance from centroid to extreme <u>top</u> fiber of slab	$y_{tc} =$	25.70 in
Section modulus for the extreme <u>bottom</u> fiber of beam	$S_{bc} =$	18,975.2 in <sup>3</sup>
Section modulus for the extreme <u>top</u> fiber of beam	$S_{tg} =$	58,213.4 in <sup>3</sup>
Section modulus for the extreme <u>top</u> fiber slab	$S_{tc} =$	40,092.3 in <sup>3</sup>

### Shear Forces and Bending Moments

#### DEAD LOADS

Beam self-weight	$w_{beam} =$	0.799 k/f
8 in. deck weight	$w_{deck} =$	1.200 k/f
1/2 in. haunch weight	$w_{haunch} =$	0.022 k/f

LRFD Specifications: Art. 4.6.2.2.1

Width of Deck Constant		OK
Number of beams is not less than four $N_b =$	4	OK
Roadway part of the overhang, $d_o = 3.0$ ft, $d_s =$	1.5	OK
Curvature in plans is less than 4° =	0	OK
Cross-section of the bridge is consistent with one of the cross sections given by LRFD specs		OK

Barrier and wearing surface loads are equally distributed among the 4 beams

Barrier Wt	$W_t =$	0.150 k/f
Dead load of future wearing surface	$DW =$	0.263 k/f

LIVE LOADS		
Fire truck live load front load (Point A)	$P_{live} =$	48.0 kips
Fire truck live load back load (Point B)	$P_{live} =$	22.0 kips
distance between two loads		19.2 ft
distance from nearest edge to point A	$x_a =$	59.0 ft
distance from nearest edge to point B	$x_b =$	39.8 ft
LRFD Specifications: Art. 4.6.2.2.1		
Width of Deck Constant		OK
Number of beams is not less than four $N_b =$	4	OK
Beams are parallel and approximately of the same stiffness		OK
Roadway part of the overhang, $d_o \leq 3.0$ ft, $d_o =$	1.5	OK
Curvature in plans is less than $4^\circ =$	0	OK

Barrier and wearing surface loads are equally distributed among the 4 beams

Bridge Type-- "k" (LRFD Table 4.6.2.2.1-1)

Number of design lanes = $w/12$	=	3 lanes
---------------------------------	---	---------

**Distribution Factor for Bending Moment:**

Beams spacing	$S =$	12.0 ft
Depth of concrete slab	$t_s =$	7.5 in
Beam Span	$L =$	120.0 ft
Number of Beams	$N_b =$	4
Modular ratio between beam & deck materials	$n =$	1.3681
Longitudinal stiffness parameter	$K_g =$	2,388,355.61 in <sup>4</sup>

at center span:		
$DFM = 0.75 + \left(\frac{S}{9.5}\right)^{1.2} + \left(\frac{S}{L}\right)^{2.2} + \left(\frac{K_g}{12 \cdot L^3 \cdot N_b^2}\right)^{0.2}$		
DFM =	0.907	lanes/beam

0.905 Controls

one design lane loaded:		
$DFM = 0.75 + \left(\frac{S}{11}\right)^{1.2} + \left(\frac{S}{L}\right)^{2.2} + \left(\frac{K_g}{12 \cdot L^3 \cdot N_b^2}\right)^{0.2}$		
DFM =	0.615	lanes/beam

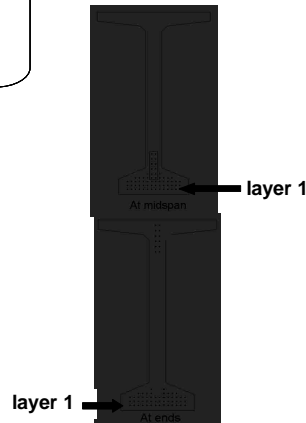
**Distribution Factor for Shear Force**

both end spans and center span:		
$DFV = C \cdot 2 - \left(\frac{S}{12}\right) - \left(\frac{S}{35}\right)^4$		
DFV =	1.082	lanes/beam

1.082 Controls

one design lane loaded:		
$DFV = 3.36 + \left(\frac{S}{25}\right)$		
DFV =	0.840	lanes/beam

from bottom	At Midspan		At Ends	
	No. of	Distance from Bottom	No. of	Distance from Bottom
layer 1	14	2	14	2
layer 2	14	3.5	14	3.5
layer 3	14	5	14	5
layer 4	10	6.5	8	6.5
layer 5	4	8	2	8
layer 6	2	10	-	-
layer 7	2	12	-	-
layer 8	2	14	-	-
layer 9	2	16	2	60
layer 10	-	-	2	62
layer 11	-	-	2	64
layer 12	-	-	2	66
layer 13	-	-	2	68
layer 14	-	-	2	70
	64		64	
Harped Strand Group (included in above totals)				
layer 3	2	6		
layer 4	2	8		
layer 5	2	10		
layer 6	2	12		
layer 7	2	14		
layer 8	2	16		



distance from the center of gravity of strands to the bottom fiber of the beam = 7% of the beam depth  
strand eccentricity at midspan =  $(y_c - y_{bs})$

$y_{bs} =$	5.44 in
$e_c =$	31.16 in

### Prestress Losses

#### ELASTIC SHORTENING

assumed loss	=	6.00%
Force per strand at transfer		
layer 1	=	17.0 kips
layer 2	=	17.0 kips
layer 3	=	17.0 kips
layer 4	=	17.0 kips
layer 5	=	17.0 kips
layer 6	=	17.0 kips
layer 7	=	17.0 kips
layer 8	=	17.0 kips
layer 9	=	17.0 kips
layer 10	=	17.0 kips
layer 11	=	17.0 kips
layer 12	=	17.0 kips
layer 13	=	17.0 kips
layer 14	=	17.0 kips

		at midspan	at endspan
Total prestressing force at release	$P_i =$	1088.0 kips	1054.0 kips
Sum of concrete stresses at the center of gravity of prestressing tendons due to prestressing force at transfer and the self-weight of the member at sections of maximum moment	$f_{ogp} =$	2.412 ksi	2.307 ksi
Loss due to shortening		at midspan	at endspan
layer 1	$\Delta f_{pES} =$	13.9 ksi	13.3 ksi
layer 2	$\Delta f_{pES} =$	13.9 ksi	13.3 ksi
layer 3	$\Delta f_{pES} =$	13.9 ksi	13.3 ksi
layer 4	$\Delta f_{pES} =$	13.9 ksi	13.3 ksi
layer 5	$\Delta f_{pES} =$	13.9 ksi	13.3 ksi
layer 6	$\Delta f_{pES} =$	13.9 ksi	
layer 7	$\Delta f_{pES} =$	13.9 ksi	
layer 8	$\Delta f_{pES} =$	13.9 ksi	
layer 9	$\Delta f_{pES} =$	13.9 ksi	13.3 ksi
layer 10	$\Delta f_{pES} =$		13.3 ksi
layer 11	$\Delta f_{pES} =$		13.3 ksi
layer 12	$\Delta f_{pES} =$		13.3 ksi
layer 13	$\Delta f_{pES} =$		13.3 ksi
layer 14	$\Delta f_{pES} =$		13.3 ksi

#### SHRINKAGE

Shrinkage = $(17 - 0.15 \times \text{Relative Humidity})$	$\Delta f_{pSR} =$	6.5 ksi	← assume relative humidity = 70%
---	--------------------	---------	----------------------------------

#### CREEP OF CONCRETE

Change of stresses at center of gravity of prestressing due to permanent loads except the loads acting at time of applying prestressing force, calculated at the same section as $f_{ogp}$	$\Delta f_{cdp} =$	1.587 ksi	
loss due to creep		at midspan	at endspan
	$\Delta f_{pCR} =$	17.8 ksi	16.6 ksi

**RELAXATION OF PRESTRESSING STRANDS**

loss due to relaxation after transfer		at midspan	at endspan
layer 1	$\Delta f_{pR2} =$	2.9 ksi	2.9 ksi
layer 2	$\Delta f_{pR2} =$	2.9 ksi	2.9 ksi
layer 3	$\Delta f_{pR2} =$	2.9 ksi	2.9 ksi
layer 4	$\Delta f_{pR2} =$	2.9 ksi	2.9 ksi
layer 5	$\Delta f_{pR2} =$	2.9 ksi	2.9 ksi
layer 6	$\Delta f_{pR2} =$	2.9 ksi	
layer 7	$\Delta f_{pR2} =$	2.9 ksi	
layer 8	$\Delta f_{pR2} =$	2.9 ksi	
layer 9	$\Delta f_{pR2} =$	2.9 ksi	2.9 ksi
layer 10	$\Delta f_{pR2} =$		2.9 ksi
layer 11	$\Delta f_{pR2} =$		2.9 ksi
layer 12	$\Delta f_{pR2} =$		2.9 ksi
layer 13	$\Delta f_{pR2} =$		2.9 ksi
layer 14	$\Delta f_{pR2} =$		2.9 ksi

**TOTAL LOSSES AT TRANSFER**

total loss $\Delta f_{pES} = \Delta f_{pi}$		at midspan	at endspan
stress in tendons after transfer $f_{pi} = f_{pi} - \Delta f_{pi}$			
layer 1	$f_{pi} =$	199.3 ksi	199.9 ksi
layer 2	$f_{pi} =$	199.3 ksi	199.9 ksi
layer 3	$f_{pi} =$	199.3 ksi	199.9 ksi
layer 4	$f_{pi} =$	199.3 ksi	199.9 ksi
layer 5	$f_{pi} =$	199.3 ksi	199.9 ksi
layer 6	$f_{pi} =$	199.3 ksi	
layer 7	$f_{pi} =$	199.3 ksi	
layer 8	$f_{pi} =$	199.3 ksi	
layer 9	$f_{pi} =$	199.3 ksi	199.9 ksi
layer 10	$f_{pi} =$		199.9 ksi
layer 11	$f_{pi} =$		199.9 ksi
layer 12	$f_{pi} =$		199.9 ksi
layer 13	$f_{pi} =$		199.9 ksi
layer 14	$f_{pi} =$		199.9 ksi
force per strand = $f_{pi} \cdot \text{strand area}$		at midspan	at endspan
layer 1	=	16.9 kips	17.0 kips
layer 2	=	16.9 kips	17.0 kips
layer 3	=	16.9 kips	17.0 kips
layer 4	=	16.9 kips	17.0 kips
layer 5	=	16.9 kips	17.0 kips
layer 6	=	16.9 kips	
layer 7	=	16.9 kips	
layer 8	=	16.9 kips	
layer 9	=	16.9 kips	17.0 kips
layer 10	=		17.0 kips
layer 11	=		17.0 kips
layer 12	=		17.0 kips
layer 13	=		17.0 kips
layer 14	=		17.0 kips
Total prestressing force after transfer		$P_1 =$	1047.8 kips
Initial loss = $(\Delta f_{pi}) / (f_{pi})$		at midspan	at endspan
layer 1	% =	6.5%	6.2%
layer 2	% =	6.5%	6.2%
layer 3	% =	6.5%	6.2%
layer 4	% =	6.5%	6.2%
layer 5	% =	6.5%	6.2%
layer 6	% =	6.5%	
layer 7	% =	6.5%	
layer 8	% =	6.5%	
layer 9	% =	6.5%	6.2%
layer 10	% =		6.2%
layer 11	% =		6.2%
layer 12	% =		6.2%
layer 13	% =		6.2%
layer 14	% =		6.2%

OK  
OK  
OK  
OK  
OK  
OK  
OK  
OK  
OK  
OK  
OK  
OK  
OK  
OK  
OK

**TOTAL LOSSES AT SERVICE LOADS**

Total Losses		at midspan	at endspan
layer 1	$\Delta f_{pT} =$	41.1 ksi	40.5 ksi
layer 2	$\Delta f_{pT} =$	41.1 ksi	40.5 ksi
layer 3	$\Delta f_{pT} =$	41.1 ksi	40.5 ksi
layer 4	$\Delta f_{pT} =$	41.1 ksi	40.5 ksi
layer 5	$\Delta f_{pT} =$	41.1 ksi	40.5 ksi
layer 6	$\Delta f_{pT} =$	41.1 ksi	
layer 7	$\Delta f_{pT} =$	41.1 ksi	
layer 8	$\Delta f_{pT} =$	41.1 ksi	
layer 9	$\Delta f_{pT} =$	41.1 ksi	40.5 ksi
layer 10	$\Delta f_{pT} =$		40.5 ksi
layer 11	$\Delta f_{pT} =$		40.5 ksi
layer 12	$\Delta f_{pT} =$		40.5 ksi
layer 13	$\Delta f_{pT} =$		40.5 ksi
layer 14	$\Delta f_{pT} =$		40.5 ksi

Stress in tendon after all losses =  $f_{pi} - \Delta f_{pi}$

		at midspan	at endspan
layer 1	$f_{pe} =$	172.0 ksi	172.7 ksi
layer 2	$f_{pe} =$	172.0 ksi	172.7 ksi
layer 3	$f_{pe} =$	172.0 ksi	172.7 ksi
layer 4	$f_{pe} =$	172.0 ksi	172.7 ksi
layer 5	$f_{pe} =$	172.0 ksi	172.7 ksi
layer 6	$f_{pe} =$	172.0 ksi	
layer 7	$f_{pe} =$	172.0 ksi	
layer 8	$f_{pe} =$	172.0 ksi	
layer 9	$f_{pe} =$	172.0 ksi	172.7 ksi
layer 10	$f_{pe} =$		172.7 ksi
layer 11	$f_{pe} =$		172.7 ksi
layer 12	$f_{pe} =$		172.7 ksi
layer 13	$f_{pe} =$		172.7 ksi
layer 14	$f_{pe} =$		172.7 ksi

check prestressing stress limit at service limit state:  $f_{pe} \leq 0.8 f_{py}$

layer 1	=	205.4 ksi
layer 2	=	205.4 ksi
layer 3	=	205.4 ksi
layer 4	=	205.4 ksi
layer 5	=	205.4 ksi
layer 6	=	205.4 ksi
layer 7	=	205.4 ksi
layer 8	=	205.4 ksi
layer 9	=	205.4 ksi
layer 10	=	205.4 ksi
layer 11	=	205.4 ksi
layer 12	=	205.4 ksi
layer 13	=	205.4 ksi
layer 14	=	205.4 ksi

OK  
OK  
OK  
OK  
OK  
OK  
OK  
OK  
OK  
OK  
OK  
OK  
OK  
OK

force per strand =  $f_{pe} \times$  strand area

		at midspan	at endspan
layer 1	=	14.6 kips	14.7 kips
layer 2	=	14.6 kips	14.7 kips
layer 3	=	14.6 kips	14.7 kips
layer 4	=	14.6 kips	14.7 kips
layer 5	=	14.6 kips	14.7 kips
layer 6	=	14.6 kips	
layer 7	=	14.6 kips	
layer 8	=	14.6 kips	
layer 9	=	14.6 kips	14.7 kips
layer 10	=		14.7 kips
layer 11	=		14.7 kips
layer 12	=		14.7 kips
layer 13	=		14.7 kips
layer 14	=		14.7 kips

		at midspan	at endspan
Total prestressing force after all losses	$P_{pe} =$	935.9 kips	939.3 kips
Final losses, % = $(\Delta f_p) / (f_{pi})$			
layer 1	% =	19.3%	19.0%
layer 2	% =	19.3%	19.0%
layer 3	% =	19.3%	19.0%
layer 4	% =	19.3%	19.0%
layer 5	% =	19.3%	19.0%
layer 6	% =	19.3%	
layer 7	% =	19.3%	
layer 8	% =	19.3%	
layer 9	% =	19.3%	19.0%
layer 10	% =		19.0%
layer 11	% =		19.0%
layer 12	% =		19.0%
layer 13	% =		19.0%
layer 14	% =		19.0%
Average final losses, %	% =	19.3%	19.0%

### Stresses at Transfer

#### STRESS LIMITS FOR CONCRETE

Compression = $0.6f_{ci}$	$f_{ci} =$	3.300 ksi
Tension		
without bonded reinforcement = $-0.0948\sqrt{f_{ci}} \leq -0.2$	=	-0.200 ksi
with bonded auxiliary reinforcement = $-0.22\sqrt{f_{ci}}$	=	-0.016 ksi

#### STRESSES AT TRANSFER LENGTH SECTION

Transfer Length = $60 \times (\text{strand diameter})$	=	1.9 ft	} Calcs for eccentricity (see 9.6.7.2)
Bending moment at transfer length	$M_{tr} =$	87.7 ft-kips	
center of 12 strands to top fiber of beam at the end	=	7.00 in	
center of 12 strands to bottom fiber of beam at the harp point	=	11.00 in	
center of 12 strands and top fiber of beam at transfer length	=	9.84 in	
center of gravity of 32 strands and bottom fiber of beam	=	3.98 in	
center of gravity of all strands and the bottom fiber of beam at transfer length	=	15.24 in	
center of gravity of all strands and the bottom fiber of beam at the end	=	15.30 in	
Eccentricity of the strand group at transfer length:	$e_{tr} =$	21.36 in	
Eccentricity at end of beam:	$e =$	21.30 in	

$$f_t = \frac{P_i}{A} - \frac{P_i e}{S_t} + \frac{M_{tr}}{S_t}$$

$$f_b = \frac{P_i}{A} + \frac{P_i e}{S_b} - \frac{M_{tr}}{S_b}$$

		at midspan	at endspan	
Top stress at top fiber of beam	$f_t =$	-0.017 ksi	-0.017 ksi	OK
Bottom stress at bottom fiber of the beam	$f_b =$	2.906 ksi	2.906 ksi	OK

#### STRESSES AT HARP POINT

Bending moment due to beam weight at 0.3L	$M_{tr} =$	1188.0 ft-kips		
Top stress at top fiber of beam	$f_t =$	0.173 ksi	0.169 ksi	OK
Bottom stress at bottom fiber of the beam	$f_b =$	2.736 ksi	2.621 ksi	OK

#### STRESSES AT MIDSPAN

Bending moment due to beam weight at 0.5L	$M_{tr} =$	1414.3 ft-kips		
Top stress at top fiber of beam	$f_t =$	0.320 ksi	0.345 ksi	OK
Bottom stress at bottom fiber of the beam	$f_b =$	2.554 ksi	2.438 ksi	OK

#### HOLD-DOWN FORCES

assume stress in strand before losses = $0.8f_u$		
layer 1	=	227.4 ksi
layer 2	=	227.4 ksi
layer 3	=	227.4 ksi
layer 4	=	227.4 ksi
layer 5	=	227.4 ksi
layer 6	=	227.4 ksi
layer 7	=	227.4 ksi
layer 8	=	227.4 ksi
layer 9	=	227.4 ksi
layer 10	=	227.4 ksi
layer 11	=	227.4 ksi
layer 12	=	227.4 ksi
layer 13	=	227.4 ksi
layer 14	=	227.4 ksi

prestress force per strand before any losses:

layer 1	=	19.3 kips
layer 2	=	19.3 kips
layer 3	=	19.3 kips
layer 4	=	19.3 kips
layer 5	=	19.3 kips
layer 6	=	19.3 kips
layer 7	=	19.3 kips
layer 8	=	19.3 kips
layer 9	=	19.3 kips
layer 10	=	19.3 kips
layer 11	=	19.3 kips
layer 12	=	19.3 kips
layer 13	=	19.3 kips
layer 14	=	19.3 kips
Harp Angle	$\psi =$	7.2 °

Hold-down force/strand

layer 1	=	2.5 kips/strand
layer 2	=	2.5 kips/strand
layer 3	=	2.5 kips/strand
layer 4	=	2.5 kips/strand
layer 5	=	2.5 kips/strand
layer 6	=	2.5 kips/strand
layer 7	=	2.5 kips/strand
layer 8	=	2.5 kips/strand
layer 9	=	2.5 kips/strand
layer 10	=	2.5 kips/strand
layer 11	=	2.5 kips/strand
layer 12	=	2.5 kips/strand
layer 13	=	2.5 kips/strand
layer 14	=	2.5 kips/strand
Total hold-down force	=	30.45 kips

### Stresses at Service Loads

#### STRESS LIMITS FOR CONCRETE

Compression:

Due to permanent loads for load combination Service I

for the precast beam	=	3.150 ksi
for deck	=	1.683 ksi

Due to permanent and transient loads for load combination Service I

for the precast beam	=	4.200 ksi
for deck	=	2.244 ksi

Tension:

Load Combination Service III

for the precast beam	=	-0.016 ksi
----------------------	---	------------

#### STRESSES AT MIDSPAN

Compression stresses at top fiber of beam	at midspan	at endspan	
$f_t = \frac{P_{ps}}{A} - \frac{P_{ps}e}{S_x} + \frac{(M_{ps} + M_d)}{S_x} + \frac{(M_{ms} - M_d)}{S_x}$			
Due to permanent loads	$f_{t0} =$	2.107 ksi	2.105 ksi
$f_{tm} = \frac{P_{ps}}{A} - \frac{P_{ps}e}{S_x} + \frac{(M_{ps} + M_d)}{S_x} + \frac{(M_{ms} + M_d)}{S_x} + \frac{(M_{ms} - M_d)}{S_x}$			
Due to permanent loads and transient loads	$f_{tm} =$	2.539 ksi	2.536 ksi
Compression stresses at top fiber of deck	at midspan	at endspan	
$f_{tr} = \frac{(M_{ms} + M_d)}{S_x}$			
Due to permanent loads	$f_{tr} =$	0.043 ksi	0.043 ksi
$f_{tr} = \frac{(M_{ms} + M_d - M_{dead})}{S_x}$			
Due to permanent loads and transient loads	$f_{tr} =$	0.499 ksi	0.499 ksi
Tension stresses at top fiber of deck	at midspan	at endspan	
$f_{tu} = \frac{P_{ps}}{A} + \frac{P_{ps}e}{S_x} - \frac{(M_{ps} + M_d)}{S_x} - \frac{(M_{ms} + M_d + 0.25 M_{dead})}{S_x}$			
Load Combination Service III	$f_{t0} =$	-0.812 ksi	-0.801 ksi

OK

OK

OK

OK

OK

**Strength Limit State**

**POSITIVE MOMENT SECTION**

$M_u = 1.25DC+1.5DW+1.75(LL+IM)$	$M_u =$	8381.5 ft-kips
effective length factor for compression members		
layer 1	k =	0.27
layer 2	k =	0.27
layer 3	k =	0.27
layer 4	k =	0.27
layer 5	k =	0.27
layer 6	k =	0.27
layer 7	k =	0.27
layer 8	k =	0.27
layer 9	k =	0.27
layer 10	k =	0.27
layer 11	k =	0.27
layer 12	k =	0.27
layer 13	k =	0.27
layer 14	k =	0.27
	c =	4.9 ft-kips

average stress in prestressing steel		
layer 1	$f_{ps} =$	279.1 ksi
layer 2	$f_{ps} =$	279.1 ksi
layer 3	$f_{ps} =$	279.1 ksi
layer 4	$f_{ps} =$	279.1 ksi
layer 5	$f_{ps} =$	279.1 ksi
layer 6	$f_{ps} =$	279.1 ksi
layer 7	$f_{ps} =$	279.1 ksi
layer 8	$f_{ps} =$	279.1 ksi
layer 9	$f_{ps} =$	279.1 ksi
layer 10	$f_{ps} =$	279.1 ksi
layer 11	$f_{ps} =$	279.1 ksi
layer 12	$f_{ps} =$	279.1 ksi
layer 13	$f_{ps} =$	279.1 ksi
layer 14	$f_{ps} =$	279.1 ksi

nominal flexure resistance		
	a =	4.18 in
$M_r = \Phi M_n, \Phi = 1.00$	$\Phi M_n =$	9168.8 ft-kips
M=DC+W+LL+IM	M =	5833.6 ft-kips

OK  
OK

**NEGATIVE MOMENT SECTION**

$M_u = 1.25DC+1.5DW+1.75(LL+IM)$	$M_u =$	-4837.2 ft-kips
	a =	5.82 in
	$\Phi M_n =$	4788.0 ft-kips
M=DC+W+LL+IM	M =	-2869.7 ft-kips

NOT OK  
OK



**Shear Design**

**CRITICAL SECTION AT 0.59**

$V_u = 1.25DC + 1.5DW + 1.75(LL + IM)$	$V_u =$	405.0 kips
$M_u = 1.25DC + 1.5DW + 1.75(LL + IM)$	$M_u =$	-2684.4 ft-kips
or		
$V_u = 1.25DC + 1.5DW + 1.75(LL + IM)$	$V_u =$	364.8 kips
$M_u = 1.25DC + 1.5DW + 1.75(LL + IM)$	$M_u =$	-2877.0 ft-kips
max shear	$V_u =$	405.0 kips
max moment	$M_u =$	2877.0 ft-kips
Shear depth	$d_v =$	73.19 in
Applied factored normal force at the section	$N_u =$	0
Angle of diagonal compressive stresses	$\theta =$	36.00 °

**STRAIN IN FLEXURAL TENSION REINFORCEMENT**

$$\epsilon_s = \frac{\frac{M_u}{S_x} - 0.5M_p + 0.5F_y A_s \sin \theta - A_s f_{ps}}{E_s A_s + E_s A_s} \leq 0.002$$

resultant compressive stress at centroid	$f_{pc} =$	at midspan	at endspan
effective stress in prestressing strand after all losses		0.921 ksi	0.923 ksi

layer 1	$f_{po} =$	176.7 ksi	177.4 ksi
layer 2	$f_{po} =$	176.7 ksi	177.4 ksi
layer 3	$f_{po} =$	176.7 ksi	177.4 ksi
layer 4	$f_{po} =$	176.7 ksi	177.4 ksi
layer 5	$f_{po} =$	176.7 ksi	
layer 6	$f_{po} =$	176.7 ksi	
layer 7	$f_{po} =$	176.7 ksi	
layer 8	$f_{po} =$	176.7 ksi	
layer 9	$f_{po} =$		177.4 ksi
layer 10	$f_{po} =$		177.4 ksi
layer 11	$f_{po} =$		177.4 ksi
layer 12	$f_{po} =$		177.4 ksi
layer 13	$f_{po} =$		177.4 ksi
layer 14	$f_{po} =$		177.4 ksi

strain in flexural tension		at midspan	at endspan
layer 1	$\epsilon_x =$	0.002000	0.002000
layer 2	$\epsilon_x =$	0.002000	0.002000
layer 3	$\epsilon_x =$	0.002000	0.002000
layer 4	$\epsilon_x =$	0.002000	0.002000
layer 5	$\epsilon_x =$	0.002000	
layer 6	$\epsilon_x =$	0.002000	
layer 7	$\epsilon_x =$	0.002000	
layer 8	$\epsilon_x =$	0.002000	
layer 9	$\epsilon_x =$		0.002000
layer 10	$\epsilon_x =$		0.002000
layer 11	$\epsilon_x =$		0.002000
layer 12	$\epsilon_x =$		0.002000
layer 13	$\epsilon_x =$		0.002000
layer 14	$\epsilon_x =$		0.002000

**Deflection and Camber**

		at midspan	at endspan
Deflection due to Prestressing Force at Transfer	$\Delta_p =$	3.27 in	3.29 in
Deflection due to Beam Self-Weight at Transfer	$\Delta_{sw} =$	-1.49 in	
Deflection due to Beam Self-Weight at Erection	$\Delta_{sw} =$	-1.44 in	
Deflection due to Haunch and Deck	$\Delta_{sw} =$	-1.95 in	

Deflection due to total self weight	$\Delta_{sw} =$	-0.11 in
-------------------------------------	-----------------	----------

Total Deflection at transfer	$\Delta =$	1.79 in	1.81 in
Total Deflection at erection	$\Delta =$	3.24 in	3.27 in

Live load deflection limit = span/800	$=$	1.80 in
Deflection due to live load and impact	$\Delta_L =$	-0.84 in

OK

Deflection due to fire truck	$\Delta_L =$	-0.7571 in
Total Deflection after fire with fire truck	$\Delta =$	2.4078 in

OK

**Location: Fire at Critical Negative Moment Sections**  
**Beam Design: 3/8" Strand**  
**Fire Exposure Status: 1 Hour**

(PCI Bridge Design Manual Section 9.6)

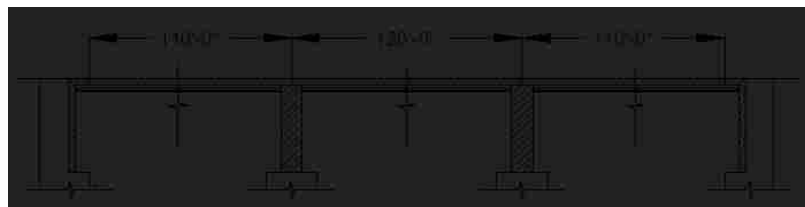


**Material Properties**

CAST-IN-PLACE SLAB		
Actual Thickness	$t_{as} =$	8.0 in
Wearing Surface	$=$	0.5 in
Structural thickness = Actual - Wearing Surface	$t_s =$	7.5 in
Compressive Strength	$f'_c =$	3.57 ksi
Unit Weight	$w_c =$	150.0 pcf
Stress factor of compression block	$\beta_1 =$	0.85

BEAMS: AASHTO-PCI, BT-72 BULB-TEE		
Strength at release	$f'_{ci} =$	5.5 ksi
Strength at 28 days	$f'_c =$	7 ksi
Unit Weight	$w_c =$	150.0 pcf
Overall Beam Length:		
@ end spans	$L =$	110 ft
@ center span	$L =$	119 ft
Design Spans:		
Non-composite beam @ end spans	$L =$	109 ft
Non-composite beam @ center span	$L =$	118 ft
Composite beam @ end spans	$L =$	110 ft
Composite beam @ center span	$L =$	120 ft
Beam Spacing	$S =$	12 ft



**PRESTRESSING STRANDS**

Diameter of single strand	d =	0.4 in
Area of single strand	A =	0.085 in <sup>2</sup>

Temperature of Layer

layer 1 (bottom)	T =	68.00 °F
layer 2	T =	68.00 °F
layer 3	T =	68.00 °F
layer 4	T =	68.00 °F
layer 5	T =	68.00 °F
layer 6	T =	68.00 °F
layer 7	T =	68.00 °F
layer 8	T =	68.00 °F
layer 9	T =	68.00 °F
layer 10	T =	68.00 °F
layer 11	T =	68.00 °F
layer 12	T =	68.00 °F
layer 13	T =	68.00 °F
layer 14	T =	68.00 °F

Ultimate Strength

initial = 284 ksi

layer 1 (bottom)	f <sub>pu</sub> =	284 ksi
layer 2	f <sub>pu</sub> =	284 ksi
layer 3	f <sub>pu</sub> =	284 ksi
layer 4	f <sub>pu</sub> =	284 ksi
layer 5	f <sub>pu</sub> =	284 ksi
layer 6	f <sub>pu</sub> =	284 ksi
layer 7	f <sub>pu</sub> =	284 ksi
layer 8	f <sub>pu</sub> =	284 ksi
layer 9	f <sub>pu</sub> =	284 ksi
layer 10	f <sub>pu</sub> =	284 ksi
layer 11	f <sub>pu</sub> =	284 ksi
layer 12	f <sub>pu</sub> =	284 ksi
layer 13	f <sub>pu</sub> =	284 ksi
layer 14	f <sub>pu</sub> =	284 ksi

Yield Strength

initial = 257 ksi

layer 1 (bottom)	f <sub>py</sub> =	257 ksi
layer 2	f <sub>py</sub> =	257 ksi
layer 3	f <sub>py</sub> =	257 ksi
layer 4	f <sub>py</sub> =	257 ksi
layer 5	f <sub>py</sub> =	257 ksi
layer 6	f <sub>py</sub> =	257 ksi
layer 7	f <sub>py</sub> =	257 ksi
layer 8	f <sub>py</sub> =	257 ksi
layer 9	f <sub>py</sub> =	257 ksi
layer 10	f <sub>py</sub> =	257 ksi
layer 11	f <sub>py</sub> =	257 ksi
layer 12	f <sub>py</sub> =	257 ksi
layer 13	f <sub>py</sub> =	257 ksi
layer 14	f <sub>py</sub> =	257 ksi

**Stress Limits:**

before transfer  $\leq 0.75f_{pu}$  (initial = 213.2)

layer 1 (bottom)	f <sub>di</sub> =	213.2 ksi
layer 2	f <sub>di</sub> =	213.2 ksi
layer 3	f <sub>di</sub> =	213.2 ksi
layer 4	f <sub>di</sub> =	213.2 ksi
layer 5	f <sub>di</sub> =	213.2 ksi
layer 6	f <sub>di</sub> =	213.2 ksi
layer 7	f <sub>di</sub> =	213.2 ksi
layer 8	f <sub>di</sub> =	213.2 ksi
layer 9	f <sub>di</sub> =	213.2 ksi
layer 10	f <sub>di</sub> =	213.2 ksi
layer 11	f <sub>di</sub> =	213.2 ksi
layer 12	f <sub>di</sub> =	213.2 ksi
layer 13	f <sub>di</sub> =	213.2 ksi
layer 14	f <sub>di</sub> =	213.2 ksi

at service limit state (after all losses)  $\leq 0.80f_{py}$  (initial = 205.4)

layer 1 (bottom)	$f_{pe} =$	205.4 ksi
layer 2	$f_{pe} =$	205.4 ksi
layer 3	$f_{pe} =$	205.4 ksi
layer 4	$f_{pe} =$	205.4 ksi
layer 5	$f_{pe} =$	205.4 ksi
layer 6	$f_{pe} =$	205.4 ksi
layer 7	$f_{pe} =$	205.4 ksi
layer 8	$f_{pe} =$	205.4 ksi
layer 9	$f_{pe} =$	205.4 ksi
layer 10	$f_{pe} =$	205.4 ksi
layer 11	$f_{pe} =$	205.4 ksi
layer 12	$f_{pe} =$	205.4 ksi
layer 13	$f_{pe} =$	205.4 ksi
layer 14	$f_{pe} =$	205.4 ksi

Modulus of Elasticity

initial = 25898 ksi

layer 1 (bottom)	$E =$	25898.0 ksi
layer 2	$E =$	25898.0 ksi
layer 3	$E =$	25898.0 ksi
layer 4	$E =$	25898.0 ksi
layer 5	$E =$	25898.0 ksi
layer 6	$E =$	25898.0 ksi
layer 7	$E =$	25898.0 ksi
layer 8	$E =$	25898.0 ksi
layer 9	$E =$	25898.0 ksi
layer 10	$E =$	25898.0 ksi
layer 11	$E =$	25898.0 ksi
layer 12	$E =$	25898.0 ksi
layer 13	$E =$	25898.0 ksi
layer 14	$E =$	25898.0 ksi

#### MILD STEEL REINFORCING BARS

Yield Strength

Layer 1 (Bottom)	$f_y =$	60.0 ksi	68.00 °F
Layer 2 (Top)	$f_y =$	57.6 ksi	820.00 °F

Modulus of Elasticity

Layer 1 (Bottom)	$E =$	29000.0 ksi
Layer 2 (Top)	$E =$	29000.0 ksi

Layer 1 (Bottom)

Area of steel at midspan (effective flange)	$A_{sm} =$	2.79 in <sup>2</sup>
Area of steel at endspan (effective flange)	$A_{se} =$	2.48 in <sup>2</sup>
Area of temperature and shrinkage steel (12" width)	$A_s =$	0.31 in <sup>2</sup>

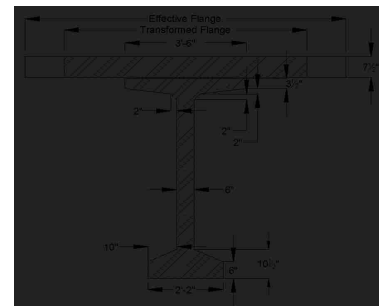
Layer 2 (Top)

Area of steel at midspan (effective flange)	$A_{sm} =$	12.6 in <sup>2</sup>
Area of steel at endspan (effective flange)	$A_{se} =$	12.4 in <sup>2</sup>
Area of temperature and shrinkage steel (12" width)	$A_s =$	0.2 in <sup>2</sup>

#### Cross-sectional Properties

##### NON-COMPOSITE BEAM

Area of cross-section of beam	$A =$	767.0 in <sup>2</sup>
Overall depth of beam	$H =$	72.0 in
Moment of Inertia	$I =$	539,947 in <sup>4</sup>
Distance from centroid to extreme <b>bottom</b> fiber	$y_b =$	36.6 in
Distance from centroid to extreme <b>top</b> fiber	$y_t =$	35.4 in
Section modulus for the extreme <b>bottom</b> fiber	$S_b =$	14915.0 in <sup>3</sup>
Section modulus for the extreme <b>top</b> fiber	$S_t =$	15421.0 in <sup>3</sup>
Weight	$W_t =$	799.0 plf
Modulus of Elasticity = $33000 \cdot (W_c / 1.5) \cdot (\sqrt{f_c})$		
cast-in-place concrete deck	$E_{cs} =$	3622 ksi
precast beam at release	$E_{ci} =$	4496 ksi
precast beam at service loads	$E_c =$	5072 ksi



### COMPOSITE BEAM AT MIDSPAN

Effective Flange Width	$b_f =$	111.0 in	*min of three criteria
Modular Ratio = $E_{cs}/E_c$	$n =$	0.7141	
Transformed flange width	$=$	79.3 in	
Transformed flange area	$=$	594.5 in <sup>2</sup>	
Transformed haunch width	$=$	30.0 in	
Transformed haunch area	$=$	15.0 in <sup>2</sup>	
Deck-distance to top fiber	$y_t =$	4.89 in	

	Transformed Area	$y_b$	$Ay_b$	$A(y_{bc}-y_b)^2$	I	$I + A(y_{bc}-y_b)^2$
Beam	767.0 in <sup>2</sup>	36.60 in	28,072.2 in <sup>3</sup>	222,211 in <sup>4</sup>	539,947 in <sup>4</sup>	762,158 in <sup>4</sup>
Haunch	15.0 in <sup>2</sup>	72.25 in	1,083.5 in <sup>3</sup>	5,205 in <sup>4</sup>	0.31 in <sup>4</sup>	5,205 in <sup>4</sup>
Deck	594.5 in <sup>2</sup>	75.11 in	44,654.7 in <sup>3</sup>	274,538 in <sup>4</sup>	1,743 in <sup>4</sup>	276,281 in <sup>4</sup>
Total	1376.5 in <sup>2</sup>		73,810.4 in <sup>3</sup>			1,043,643 in <sup>4</sup>

Total area of Composite Section	$A_c =$	1377 in <sup>2</sup>
Overall Depth of the Composite Section	$h_c =$	80 in
Moment of Inertia	$I_c =$	1,043,643 in <sup>4</sup>
Distance from centroid to extreme <u>bottom</u> fiber of beam	$y_{bc} =$	53.62 in
Distance from centroid to extreme <u>top</u> fiber of beam	$y_{tg} =$	18.38 in
Distance from centroid to extreme <u>top</u> fiber of slab	$y_{tc} =$	26.38 in
Section modulus for the extreme <u>bottom</u> fiber of beam	$S_{bc} =$	19,463.3 in <sup>3</sup>
Section modulus for the extreme <u>top</u> fiber of beam	$S_{tg} =$	56,784.5 in <sup>3</sup>
Section modulus for the extreme <u>top</u> fiber of slab	$S_{tc} =$	55,399.9 in <sup>3</sup>

### COMPOSITE BEAM AT ENDSPAN

Effective Flange Width	$b_f =$	106.6 in	*min of three criteria
Modular Ratio = $E_{cs}/E_c$	$n =$	0.7141	
Transformed flange width	$=$	76.1 in	
Transformed flange area	$=$	571.0 in <sup>2</sup>	
Transformed haunch width	$=$	30.0 in	
Transformed haunch area	$=$	15.0 in <sup>2</sup>	
Deck-distance to top fiber	$y_{td} =$	4.89 in	

	Transformed Area	$y_t$	$Ay_t$	$A(y_{tc}-y_t)^2$	I	$I + A(y_{tc}-y_t)^2$
Beam	767.0 in <sup>2</sup>	36.60 in	28,072.2 in <sup>3</sup>	271,344 in <sup>4</sup>	539,947 in <sup>4</sup>	811,291 in <sup>4</sup>
Haunch	15.0 in <sup>2</sup>	72.25 in	1,083.5 in <sup>3</sup>	5,306 in <sup>4</sup>	0.31 in <sup>4</sup>	5,306 in <sup>4</sup>
Deck	571.0 in <sup>2</sup>	77.39 in	44,186.4 in <sup>3</sup>	201,989 in <sup>4</sup>	1,677 in <sup>4</sup>	203,666 in <sup>4</sup>
Total	1353.0 in <sup>2</sup>		73,342.1 in <sup>3</sup>			1,020,264 in <sup>4</sup>

Total area of Composite Section	$A_c =$	1353 in <sup>2</sup>
Overall Depth of the Composite Section	$h_c =$	80 in
Moment of Inertia	$I_c =$	1,020,264 in <sup>4</sup>
Distance from centroid to extreme <u>bottom</u> fiber of beam	$y_{bc} =$	54.21 in
Distance from centroid to extreme <u>top</u> fiber of beam	$y_{tg} =$	17.79 in
Distance from centroid to extreme <u>top</u> fiber of slab	$y_{tc} =$	25.79 in
Section modulus for the extreme <u>bottom</u> fiber of beam	$S_{bc} =$	18,821.0 in <sup>3</sup>
Section modulus for the extreme <u>top</u> fiber of beam	$S_{tg} =$	57,346.7 in <sup>3</sup>
Section modulus for the extreme <u>top</u> fiber of slab	$S_{tc} =$	39,558.7 in <sup>3</sup>

### Shear Forces and Bending Moments

#### DEAD LOADS

Beam self-weight	$W_{beam} =$	0.799 k/f
8 in. deck weight	$W_{deck} =$	1.200 k/f
1/2 in. haunch weight	$W_{haunch} =$	0.022 k/f

#### LRFD Specifications: Art. 4.6.2.2.1

Width of Deck Constant		OK
Number of beams is not less than four $N_b =$	4	OK
Roadway part of the overhang, $d_s \leq 3.0$ ft, $d_s =$	1.5	OK
Curvature in plans is less than 4° =	0	OK
Cross-section of the bridge is consistent with one of the cross sections given by LRFD specs		OK

Barrier and wearing surface loads are equally distributed among the 4 beams

Barrier Wt	$W_t =$	0.150 k/f
Dead load of future wearing surface	$DW =$	0.263 k/f

LIVE LOADS		
Fire truck live load front load (Point A)	$P_{live} =$	48.0 kips
Fire truck live load back load (Point B)	$P_{live} =$	22.0 kips
distance between two loads		19.2 ft
distance from nearest edge to point A	$x_a =$	59.0 ft
distance from nearest edge to point B	$x_b =$	39.8 ft
LRFD Specifications: Art. 4.6.2.2.1		
Width of Deck Constant		OK
Number of beams is not less than four $N_b =$	4	OK
Beams are parallel and approximately of the same stiffness		OK
Roadway part of the overhang, $d_s \leq 3.0$ ft, $d_e =$	1.5	OK
Curvature in plans is less than $4^\circ =$	0	OK

Barrier and wearing surface loads are equally distributed among the 4 beams

Bridge Type-- "k" (LRFD Table 4.6.2.2.1-1)		
Number of design lanes = $w/12$	=	3 lanes

#### Distribution Factor for Bending Moment:

Beams spacing	$S =$	12.0 ft
Depth of concrete slab	$t_s =$	7.5 in
Beam Span	$L =$	120.0 ft
Number of Beams	$N_b =$	4
Modular ratio between beam & deck materials	$n =$	1.4003
Longitudinal stiffness parameter	$K_g =$	2,444,559.90 in <sup>4</sup>

at center span:		
$DFM = 0.75 \left[ \left( \frac{S}{3.5} \right)^{0.1} + \left( \frac{S}{L} \right)^{0.2} + \left( \frac{K_g}{12 * L * t_s^3} \right)^{0.1} \right]$		
DFM =	0.909 lanes/beam	

0.905 Controls

one design lane loaded:		
$DFM = 0.75 + \left( \frac{S}{4} \right)^{0.4} + \left( \frac{S}{L} \right)^{0.3} + \left( \frac{K_g}{2 * L * t_s^3} \right)^{0.1}$		
DFM =	0.617 lanes/beam	

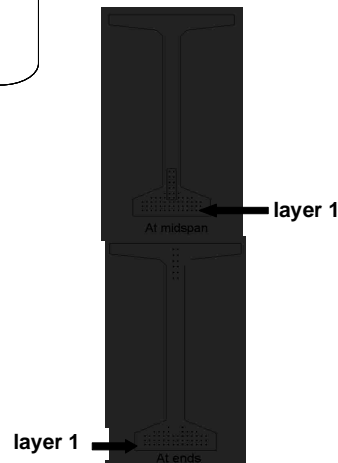
#### Distribution Factor for Shear Force

both end spans and center span:		
$DFV = 0.2 + \left( \frac{S}{12} \right) - \left( \frac{S}{35} \right)^2$		
DFV =	1.082 lanes/beam	

1.082 Controls

one design lane loaded:		
$DFV = 0.36 + \left( \frac{S}{25} \right)$		
DFV =	0.840 lanes/beam	

from bottom	At Midspan		At Ends	
	No. of	Distance from Bottom	No. of	Distance from Bottom
layer 1	14	2	14	2
layer 2	14	3.5	14	3.5
layer 3	14	5	14	5
layer 4	10	6.5	8	6.5
layer 5	4	8	2	8
layer 6	2	10	-	-
layer 7	2	12	-	-
layer 8	2	14	-	-
layer 9	2	16	2	60
layer 10	-	-	2	62
layer 11	-	-	2	64
layer 12	-	-	2	66
layer 13	-	-	2	68
layer 14	-	-	2	70
	64		64	
<b>Harped Strand Group (included in above totals)</b>				
layer 3	2	6		
layer 4	2	8		
layer 5	2	10		
layer 6	2	12		
layer 7	2	14		
layer 8	2	16		



distance from the center of gravity of strands to the bottom fiber of the beam = 7% of the beam depth  
strand eccentricity at midspan =  $(y_c - y_{bs})$

$y_{bs} =$	5.44 in
$e_c =$	31.16 in

### Prestress Losses

#### ELASTIC SHORTENING

assumed loss	=	6.00%
Force per strand at transfer		
layer 1	=	17.0 kips
layer 2	=	17.0 kips
layer 3	=	17.0 kips
layer 4	=	17.0 kips
layer 5	=	17.0 kips
layer 6	=	17.0 kips
layer 7	=	17.0 kips
layer 8	=	17.0 kips
layer 9	=	17.0 kips
layer 10	=	17.0 kips
layer 11	=	17.0 kips
layer 12	=	17.0 kips
layer 13	=	17.0 kips
layer 14	=	17.0 kips

Total prestressing force at release	$P_1 =$	at midspan 1088.0 kips	at endspan 1054.0 kips
Sum of concrete stresses at the center of gravity of prestressing tendons due to prestressing force at transfer and the self-weight of the member at sections of maximum moment	$f_{cgp} =$	2.412 ksi	2.307 ksi

Loss due to shortening		at midspan	at endspan
layer 1	$\Delta f_{pES} =$	13.9 ksi	13.3 ksi
layer 2	$\Delta f_{pES} =$	13.9 ksi	13.3 ksi
layer 3	$\Delta f_{pES} =$	13.9 ksi	13.3 ksi
layer 4	$\Delta f_{pES} =$	13.9 ksi	13.3 ksi
layer 5	$\Delta f_{pES} =$	13.9 ksi	13.3 ksi
layer 6	$\Delta f_{pES} =$	13.9 ksi	
layer 7	$\Delta f_{pES} =$	13.9 ksi	
layer 8	$\Delta f_{pES} =$	13.9 ksi	
layer 9	$\Delta f_{pES} =$	13.9 ksi	13.3 ksi
layer 10	$\Delta f_{pES} =$		13.3 ksi
layer 11	$\Delta f_{pES} =$		13.3 ksi
layer 12	$\Delta f_{pES} =$		13.3 ksi
layer 13	$\Delta f_{pES} =$		13.3 ksi
layer 14	$\Delta f_{pES} =$		13.3 ksi

#### SHRINKAGE

Shrinkage = $(17 - 0.15 \times \text{Relative Humidity})$	$\Delta f_{pSR} =$	6.5 ksi	← assume relative humidity = 70%
---	--------------------	---------	----------------------------------

#### CREEP OF CONCRETE

Change of stresses at center of gravity of prestressing due to permanent loads except the loads acting at time of applying prestressing force, calculated at the same section as $f_{cgp}$	$\Delta f_{cgp} =$	1.588 ksi	
loss due to creep	$\Delta f_{pCR} =$	at midspan 17.8 ksi	at endspan 16.6 ksi

**RELAXATION OF PRESTRESSING STRANDS**

loss due to relaxation after transfer		at midspan	at endspan
layer 1	$\Delta f_{PR2} =$	2.9 ksi	2.9 ksi
layer 2	$\Delta f_{PR2} =$	2.9 ksi	2.9 ksi
layer 3	$\Delta f_{PR2} =$	2.9 ksi	2.9 ksi
layer 4	$\Delta f_{PR2} =$	2.9 ksi	2.9 ksi
layer 5	$\Delta f_{PR2} =$	2.9 ksi	2.9 ksi
layer 6	$\Delta f_{PR2} =$	2.9 ksi	
layer 7	$\Delta f_{PR2} =$	2.9 ksi	
layer 8	$\Delta f_{PR2} =$	2.9 ksi	
layer 9	$\Delta f_{PR2} =$	2.9 ksi	2.9 ksi
layer 10	$\Delta f_{PR2} =$		2.9 ksi
layer 11	$\Delta f_{PR2} =$		2.9 ksi
layer 12	$\Delta f_{PR2} =$		2.9 ksi
layer 13	$\Delta f_{PR2} =$		2.9 ksi
layer 14	$\Delta f_{PR2} =$		2.9 ksi

**TOTAL LOSSES AT TRANSFER**

total loss  $\Delta f_{pES} = \Delta f_{pl}$

stress in tendons after transfer  $f_{pt} = f_{pr} - \Delta f_{pl}$

		at midspan	at endspan
layer 1	$f_{pt} =$	199.3 ksi	199.9 ksi
layer 2	$f_{pt} =$	199.3 ksi	199.9 ksi
layer 3	$f_{pt} =$	199.3 ksi	199.9 ksi
layer 4	$f_{pt} =$	199.3 ksi	199.9 ksi
layer 5	$f_{pt} =$	199.3 ksi	199.9 ksi
layer 6	$f_{pt} =$	199.3 ksi	
layer 7	$f_{pt} =$	199.3 ksi	
layer 8	$f_{pt} =$	199.3 ksi	
layer 9	$f_{pt} =$	199.3 ksi	199.9 ksi
layer 10	$f_{pt} =$		199.9 ksi
layer 11	$f_{pt} =$		199.9 ksi
layer 12	$f_{pt} =$		199.9 ksi
layer 13	$f_{pt} =$		199.9 ksi
layer 14	$f_{pt} =$		199.9 ksi

force per strand =  $f_{pt} \cdot \text{strand area}$

		at midspan	at endspan
layer 1	=	16.9 kips	17.0 kips
layer 2	=	16.9 kips	17.0 kips
layer 3	=	16.9 kips	17.0 kips
layer 4	=	16.9 kips	17.0 kips
layer 5	=	16.9 kips	17.0 kips
layer 6	=	16.9 kips	
layer 7	=	16.9 kips	
layer 8	=	16.9 kips	
layer 9	=	16.9 kips	17.0 kips
layer 10	=		17.0 kips
layer 11	=		17.0 kips
layer 12	=		17.0 kips
layer 13	=		17.0 kips
layer 14	=		17.0 kips

Total prestressing force after transfer

Initial loss =  $(\Delta f_{pl}) / (f_{pi})$

		at midspan	at endspan
layer 1	% =	6.5%	6.2%
layer 2	% =	6.5%	6.2%
layer 3	% =	6.5%	6.2%
layer 4	% =	6.5%	6.2%
layer 5	% =	6.5%	6.2%
layer 6	% =	6.5%	
layer 7	% =	6.5%	
layer 8	% =	6.5%	
layer 9	% =	6.5%	6.2%
layer 10	% =		6.2%
layer 11	% =		6.2%
layer 12	% =		6.2%
layer 13	% =		6.2%
layer 14	% =		6.2%

OK  
OK  
OK  
OK  
OK  
OK  
OK  
OK  
OK  
OK  
OK  
OK  
OK  
OK



**TOTAL LOSSES AT SERVICE LOADS**

Total Losses		at midspan	at endspan
layer 1	$\Delta f_{pT} =$	41.1 ksi	40.5 ksi
layer 2	$\Delta f_{pT} =$	41.1 ksi	40.5 ksi
layer 3	$\Delta f_{pT} =$	41.1 ksi	40.5 ksi
layer 4	$\Delta f_{pT} =$	41.1 ksi	40.5 ksi
layer 5	$\Delta f_{pT} =$	41.1 ksi	40.5 ksi
layer 6	$\Delta f_{pT} =$	41.1 ksi	
layer 7	$\Delta f_{pT} =$	41.1 ksi	
layer 8	$\Delta f_{pT} =$	41.1 ksi	
layer 9	$\Delta f_{pT} =$	41.1 ksi	40.5 ksi
layer 10	$\Delta f_{pT} =$		40.5 ksi
layer 11	$\Delta f_{pT} =$		40.5 ksi
layer 12	$\Delta f_{pT} =$		40.5 ksi
layer 13	$\Delta f_{pT} =$		40.5 ksi
layer 14	$\Delta f_{pT} =$		40.5 ksi

Stress in tendon after all losses = $f_{pi} - \Delta f_{pi}$		at midspan	at endspan
layer 1	$f_{pe} =$	172.1 ksi	172.7 ksi
layer 2	$f_{pe} =$	172.1 ksi	172.7 ksi
layer 3	$f_{pe} =$	172.1 ksi	172.7 ksi
layer 4	$f_{pe} =$	172.1 ksi	172.7 ksi
layer 5	$f_{pe} =$	172.1 ksi	172.7 ksi
layer 6	$f_{pe} =$	172.1 ksi	
layer 7	$f_{pe} =$	172.1 ksi	
layer 8	$f_{pe} =$	172.1 ksi	
layer 9	$f_{pe} =$	172.1 ksi	172.7 ksi
layer 10	$f_{pe} =$		172.7 ksi
layer 11	$f_{pe} =$		172.7 ksi
layer 12	$f_{pe} =$		172.7 ksi
layer 13	$f_{pe} =$		172.7 ksi
layer 14	$f_{pe} =$		172.7 ksi

check prestressing stress limit at service limit state:  $f_{pe} \leq 0.8 \cdot f_{py}$

layer 1	=	205.4 ksi
layer 2	=	205.4 ksi
layer 3	=	205.4 ksi
layer 4	=	205.4 ksi
layer 5	=	205.4 ksi
layer 6	=	205.4 ksi
layer 7	=	205.4 ksi
layer 8	=	205.4 ksi
layer 9	=	205.4 ksi
layer 10	=	205.4 ksi
layer 11	=	205.4 ksi
layer 12	=	205.4 ksi
layer 13	=	205.4 ksi
layer 14	=	205.4 ksi

OK  
OK  
OK  
OK  
OK  
OK  
OK  
OK  
OK  
OK  
OK  
OK  
OK  
OK

force per strand =  $f_{pe} \cdot \text{strand area}$

		at midspan	at endspan
layer 1	=	14.6 kips	14.7 kips
layer 2	=	14.6 kips	14.7 kips
layer 3	=	14.6 kips	14.7 kips
layer 4	=	14.6 kips	14.7 kips
layer 5	=	14.6 kips	14.7 kips
layer 6	=	14.6 kips	
layer 7	=	14.6 kips	
layer 8	=	14.6 kips	
layer 9	=	14.6 kips	14.7 kips
layer 10	=		14.7 kips
layer 11	=		14.7 kips
layer 12	=		14.7 kips
layer 13	=		14.7 kips
layer 14	=		14.7 kips

		at midspan	at endspan
Total prestressing force after all losses	$P_{pe} =$	936.0 kips	939.3 kips
Final losses, % = $(\Delta f_{pT})/f_{pi}$			
layer 1	% =	19.3%	19.0%
layer 2	% =	19.3%	19.0%
layer 3	% =	19.3%	19.0%
layer 4	% =	19.3%	19.0%
layer 5	% =	19.3%	19.0%
layer 6	% =	19.3%	
layer 7	% =	19.3%	
layer 8	% =	19.3%	
layer 9	% =	19.3%	19.0%
layer 10	% =		19.0%
layer 11	% =		19.0%
layer 12	% =		19.0%
layer 13	% =		19.0%
layer 14	% =		19.0%
Average final losses, %	% =	19.3%	19.0%

### Stresses at Transfer

#### STRESS LIMITS FOR CONCRETE

Compression = $0.6f'_{ci}$	$f_{ci} =$	3.300 ksi
Tension		
without bonded reinforcement = $-0.0948\sqrt{f'_{ci}} \leq -0.2$	=	-0.200 ksi
with bonded auxiliary reinforcement = $-0.22\sqrt{f'_{ci}}$	=	-0.016 ksi

#### STRESSES AT TRANSFER LENGTH SECTION

Transfer Length = $60 \times (\text{strand diameter})$	=	1.9 ft	} Calcs for eccentricity (see 9.6.7.2)
Bending moment at transfer length	$M_g =$	87.7 ft-kips	
center of 12 strands to top fiber of beam at the end	=	7.00 in	
center of 12 strands to bottom fiber of beam at the harp point	=	11.00 in	
center of 12 strands and top fiber of beam at transfer length	=	9.84 in	
center of gravity of 32 strands and bottom fiber of beam	=	3.98 in	
center of gravity of all strands and the bottom fiber of beam at transfer length	=	15.24 in	
center of gravity of all strands and the bottom fiber of beam at the end	=	15.30 in	
Eccentricity of the strand group at transfer length:	$e_h =$	21.36 in	}
Eccentricity at end of beam:	$e =$	21.30 in	

$$f_t = \frac{P_i}{A} - \frac{P_i e}{S_t} + \frac{M_g}{S_t}$$

$$f_b = \frac{P_i}{A} + \frac{P_i e}{S_b} - \frac{M_g}{S_b}$$

		at midspan	at endspan	
Top stress at top fiber of beam	$f_t =$	-0.017 ksi	-0.017 ksi	OK
Bottom stress at bottom fiber of the beam	$f_b =$	2.906 ksi	2.906 ksi	OK

#### STRESSES AT HARP POINT

Bending moment due to beam weight at 0.3L	$M_g =$	1188.0 ft-kips		
Top stress at top fiber of beam	$f_t =$	0.173 ksi	0.169 ksi	OK
Bottom stress at bottom fiber of the beam	$f_b =$	2.736 ksi	2.621 ksi	OK

#### STRESSES AT MIDSPAN

Bending moment due to beam weight at 0.5L	$M_g =$	1414.3 ft-kips		
Top stress at top fiber of beam	$f_t =$	0.320 ksi	0.345 ksi	OK
Bottom stress at bottom fiber of the beam	$f_b =$	2.554 ksi	2.438 ksi	OK

#### HOLD-DOWN FORCES

assume stress in strand before losses =  $0.8f_u$

layer 1	=	227.4 ksi
layer 2	=	227.4 ksi
layer 3	=	227.4 ksi
layer 4	=	227.4 ksi
layer 5	=	227.4 ksi
layer 6	=	227.4 ksi
layer 7	=	227.4 ksi
layer 8	=	227.4 ksi
layer 9	=	227.4 ksi
layer 10	=	227.4 ksi
layer 11	=	227.4 ksi
layer 12	=	227.4 ksi
layer 13	=	227.4 ksi
layer 14	=	227.4 ksi

prestress force per strand before any losses:

layer 1	=	19.3 kips
layer 2	=	19.3 kips
layer 3	=	19.3 kips
layer 4	=	19.3 kips
layer 5	=	19.3 kips
layer 6	=	19.3 kips
layer 7	=	19.3 kips
layer 8	=	19.3 kips
layer 9	=	19.3 kips
layer 10	=	19.3 kips
layer 11	=	19.3 kips
layer 12	=	19.3 kips
layer 13	=	19.3 kips
layer 14	=	19.3 kips
Harp Angle	$\psi$ =	7.2 °

Hold-down force/strand

layer 1	=	2.5 kips/strand
layer 2	=	2.5 kips/strand
layer 3	=	2.5 kips/strand
layer 4	=	2.5 kips/strand
layer 5	=	2.5 kips/strand
layer 6	=	2.5 kips/strand
layer 7	=	2.5 kips/strand
layer 8	=	2.5 kips/strand
layer 9	=	2.5 kips/strand
layer 10	=	2.5 kips/strand
layer 11	=	2.5 kips/strand
layer 12	=	2.5 kips/strand
layer 13	=	2.5 kips/strand
layer 14	=	2.5 kips/strand
Total hold-down force	=	30.45 kips

### Stresses at Service Loads

#### STRESS LIMITS FOR CONCRETE

Compression:

Due to permanent loads for load combination Service I

for the precast beam	=	3.150 ksi
for deck	=	1.607 ksi

Due to permanent and transient loads for load combination Service I

for the precast beam	=	4.200 ksi
for deck	=	2.142 ksi

Tension:

Load Combination Service III

for the precast beam	=	-0.016 ksi
----------------------	---	------------

#### STRESSES AT MIDSPAN

Compression stresses at top fiber of beam	at midspan	at endspan		
$f_1 = \frac{P_{pe}}{A} - \frac{P_{pe}e}{S_1} + \frac{(M_w + M_d)}{S_1} + \frac{(M_w + M_b)}{S_{2g}}$	$f_{1g} =$	2.109 ksi	2.106 ksi	OK
Due to permanent loads				
$f_{1g} = \frac{P_M}{A} - \frac{P_{pe}e}{S_1} + \frac{(M_w + M_d)}{S_1} + \frac{(M_w - M_b)}{S_{2g}} + \frac{(M_{LL+I})}{S_{2g}}$	$f_{1g} =$	2.556 ksi	2.553 ksi	OK
Due to permanent loads and transient loads				
<b>Compression stresses at top fiber of deck</b>	<b>at midspan</b>	<b>at endspan</b>		
$f_{1g} = \frac{(M_w + M_b)}{S_{2c}}$	$f_{1c} =$	0.044 ksi	0.044 ksi	OK
Due to permanent loads				
$f_{1g} = \frac{(M_w + M_b + M_{LL+I})}{S_{2c}}$	$f_{1c} =$	0.502 ksi	0.502 ksi	OK
Due to permanent loads and transient loads				
<b>Tension stresses at top fiber of deck</b>	<b>at midspan</b>	<b>at endspan</b>		
$f_{1g} = \frac{P_{pe}}{A} + \frac{P_{pe}e}{S_2} - \frac{(M_w + M_d)}{S_2} - \frac{(M_w + M_b + 0.8 * M_{LL+I})}{S_{2c}}$	$f_{1c} =$	-0.821 ksi	-0.810 ksi	OK
Load Combination Service III				

**Strength Limit State**

POSITIVE MOMENT SECTION		
$M_u = 1.25DC+1.5DW+1.75(LL+IM)$	$M_u =$	8381.5 ft-kips
effective length factor for compression members		
layer 1	k =	0.27
layer 2	k =	0.27
layer 3	k =	0.27
layer 4	k =	0.27
layer 5	k =	0.27
layer 6	k =	0.27
layer 7	k =	0.27
layer 8	k =	0.27
layer 9	k =	0.27
layer 10	k =	0.27
layer 11	k =	0.27
layer 12	k =	0.27
layer 13	k =	0.27
layer 14	k =	0.27
	c =	5.2 ft-kips
average stress in prestressing steel		
layer 1	$f_{ps} =$	278.8 ksi
layer 2	$f_{ps} =$	278.8 ksi
layer 3	$f_{ps} =$	278.8 ksi
layer 4	$f_{ps} =$	278.8 ksi
layer 5	$f_{ps} =$	278.8 ksi
layer 6	$f_{ps} =$	278.8 ksi
layer 7	$f_{ps} =$	278.8 ksi
layer 8	$f_{ps} =$	278.8 ksi
layer 9	$f_{ps} =$	278.8 ksi
layer 10	$f_{ps} =$	278.8 ksi
layer 11	$f_{ps} =$	278.8 ksi
layer 12	$f_{ps} =$	278.8 ksi
layer 13	$f_{ps} =$	278.8 ksi
layer 14	$f_{ps} =$	278.8 ksi
nominal flexure resistance		
	a =	4.38 in
$M_r = \Phi M_n, \Phi = 1.00$	$\Phi M_n =$	9148.6 ft-kips
M=DC+W+LL+IM	M =	5833.6 ft-kips
NEGATIVE MOMENT SECTION		
$M_u = 1.25DC+1.5DW+1.75(LL+IM)$	$M_u =$	-4837.2 ft-kips
	a =	5.77 in
	$\Phi M_n =$	4748.7 ft-kips
M=DC+W+LL+IM	M =	-2869.7 ft-kips

OK

OK

NOT OK

OK

### Shear Design

CRITICAL SECTION AT 0.59		
$V_u = 1.25DC + 1.5DW + 1.75(LL + IM)$	$V_u =$	405.0 kips
$M_u = 1.25DC + 1.5DW + 1.75(LL + IM)$	$M_u =$	-2684.4 ft-kips
or		
$V_u = 1.25DC + 1.5DW + 1.75(LL + IM)$	$V_u =$	364.8 kips
$M_u = 1.25DC + 1.5DW + 1.75(LL + IM)$	$M_u =$	-2877.0 ft-kips
max shear	$V_u =$	405.0 kips
max moment	$M_u =$	2877.0 ft-kips
Shear depth	$d_v =$	73.19 in
Applied factored normal force at the section	$N_u =$	0
Angle of diagonal compressive stresses	$\theta =$	36.00 °

### STRAIN IN FLEXURAL TENSION REINFORCEMENT

$$\epsilon_s = \frac{\frac{M_u}{d_v} + 0.5N_u \cot \theta + A_{ps} f_{ps}}{E_s A_s + E_p A_{ps}} \leq 0.002$$

	at midspan	at endspan
resultant compressive stress at centroid	$f_{pc} =$ 0.927 ksi	0.929 ksi

effective stress in prestressing strand after all losses

	at midspan	at endspan
layer 1	$f_{po} =$ 176.8 ksi	177.4 ksi
layer 2	$f_{po} =$ 176.8 ksi	177.4 ksi
layer 3	$f_{po} =$ 176.8 ksi	177.4 ksi
layer 4	$f_{po} =$ 176.8 ksi	177.4 ksi
layer 5	$f_{po} =$ 176.8 ksi	
layer 6	$f_{po} =$ 176.8 ksi	
layer 7	$f_{po} =$ 176.8 ksi	
layer 8	$f_{po} =$ 176.8 ksi	
layer 9	$f_{po} =$	177.4 ksi
layer 10	$f_{po} =$	177.4 ksi
layer 11	$f_{po} =$	177.4 ksi
layer 12	$f_{po} =$	177.4 ksi
layer 13	$f_{po} =$	177.4 ksi
layer 14	$f_{po} =$	177.4 ksi

strain in flexural tension

	at midspan	at endspan
layer 1	$\epsilon_x =$ 0.002000	0.002000
layer 2	$\epsilon_x =$ 0.002000	0.002000
layer 3	$\epsilon_x =$ 0.002000	0.002000
layer 4	$\epsilon_x =$ 0.002000	0.002000
layer 5	$\epsilon_x =$ 0.002000	
layer 6	$\epsilon_x =$ 0.002000	
layer 7	$\epsilon_x =$ 0.002000	
layer 8	$\epsilon_x =$ 0.002000	
layer 9	$\epsilon_x =$	0.002000
layer 10	$\epsilon_x =$	0.002000
layer 11	$\epsilon_x =$	0.002000
layer 12	$\epsilon_x =$	0.002000
layer 13	$\epsilon_x =$	0.002000
layer 14	$\epsilon_x =$	0.002000

### Deflection and Camber

	at midspan	at endspan
Deflection due to Prestressing Force at Transfer	$\Delta_p =$ 3.27 in	3.29 in
Deflection due to Beam Self-Weight at Transfer	$\Delta_g =$ -1.49 in	
Deflection due to Beam Self-Weight at Erection	$\Delta_g =$ -1.44 in	
Deflection due to Haunch and Deck	$\Delta_g =$ -1.95 in	

Deflection due to total self weight	$\Delta_{sw} =$ -0.11 in
-------------------------------------	--------------------------

Total Deflection at transfer	$\Delta =$ 1.79 in	1.81 in
Total Deflection at erection	$\Delta =$ 3.24 in	3.27 in

Live load deflection limit = span/800	$=$ 1.80 in
Deflection due to live load and impact	$\Delta_L =$ -0.85 in

OK

Deflection due to fire truck	$\Delta_L =$ -0.7646 in
Total Deflection after fire with fire truck	$\Delta =$ 2.4003 in

OK

**Location: Fire at Critical Negative Moment Sections**  
**Beam Design: 3/8" Strand**  
**Fire Exposure Status: 1-1/2 Hour**

(PCI Bridge Design Manual Section 9.6)

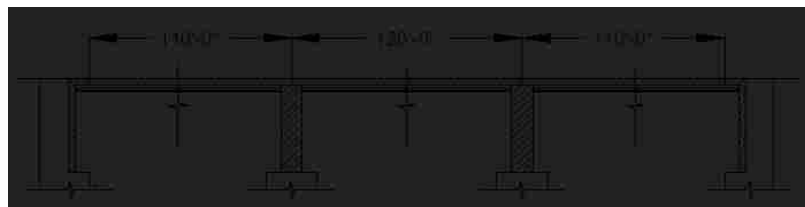


**Material Properties**

CAST-IN-PLACE SLAB		
Actual Thickness	$t_{as} =$	8.0 in
Wearing Surface	$=$	0.5 in
Structural thickness = Actual - Wearing Surface	$t_s =$	7.5 in
Compressive Strength	$f'_c =$	3.39 ksi
Unit Weight	$w_c =$	150.0 pcf
Stress factor of compression block	$\beta_1 =$	0.85

BEAMS: AASHTO-PCI, BT-72 BULB-TEE		
Strength at release	$f'_{ci} =$	5.5 ksi
Strength at 28 days	$f'_c =$	7 ksi
Unit Weight	$w_c =$	150.0 pcf
Overall Beam Length:		
@ end spans	$L =$	110 ft
@ center span	$L =$	119 ft
Design Spans:		
Non-composite beam @ end spans	$L =$	109 ft
Non-composite beam @ center span	$L =$	118 ft
Composite beam @ end spans	$L =$	110 ft
Composite beam @ center span	$L =$	120 ft
Beam Spacing	$S =$	12 ft



**PRESTRESSING STRANDS**

Diameter of single strand	d =	0.4 in
Area of single strand	A =	0.085 in <sup>2</sup>

Temperature of Layer

layer 1 (bottom)	T =	68.00 °F
layer 2	T =	68.00 °F
layer 3	T =	68.00 °F
layer 4	T =	68.00 °F
layer 5	T =	68.00 °F
layer 6	T =	68.00 °F
layer 7	T =	68.00 °F
layer 8	T =	68.00 °F
layer 9	T =	68.00 °F
layer 10	T =	68.00 °F
layer 11	T =	68.00 °F
layer 12	T =	68.00 °F
layer 13	T =	68.00 °F
layer 14	T =	68.00 °F

Ultimate Strength

initial = 284 ksi

layer 1 (bottom)	f <sub>pu</sub> =	284 ksi
layer 2	f <sub>pu</sub> =	284 ksi
layer 3	f <sub>pu</sub> =	284 ksi
layer 4	f <sub>pu</sub> =	284 ksi
layer 5	f <sub>pu</sub> =	284 ksi
layer 6	f <sub>pu</sub> =	284 ksi
layer 7	f <sub>pu</sub> =	284 ksi
layer 8	f <sub>pu</sub> =	284 ksi
layer 9	f <sub>pu</sub> =	284 ksi
layer 10	f <sub>pu</sub> =	284 ksi
layer 11	f <sub>pu</sub> =	284 ksi
layer 12	f <sub>pu</sub> =	284 ksi
layer 13	f <sub>pu</sub> =	284 ksi
layer 14	f <sub>pu</sub> =	284 ksi

Yield Strength

initial = 257 ksi

layer 1 (bottom)	f <sub>py</sub> =	257 ksi
layer 2	f <sub>py</sub> =	257 ksi
layer 3	f <sub>py</sub> =	257 ksi
layer 4	f <sub>py</sub> =	257 ksi
layer 5	f <sub>py</sub> =	257 ksi
layer 6	f <sub>py</sub> =	257 ksi
layer 7	f <sub>py</sub> =	257 ksi
layer 8	f <sub>py</sub> =	257 ksi
layer 9	f <sub>py</sub> =	257 ksi
layer 10	f <sub>py</sub> =	257 ksi
layer 11	f <sub>py</sub> =	257 ksi
layer 12	f <sub>py</sub> =	257 ksi
layer 13	f <sub>py</sub> =	257 ksi
layer 14	f <sub>py</sub> =	257 ksi

**Stress Limits:**

before transfer ≤ 0.75f<sub>pu</sub> (initial = 213.2)

layer 1 (bottom)	f <sub>di</sub> =	213.2 ksi
layer 2	f <sub>di</sub> =	213.2 ksi
layer 3	f <sub>di</sub> =	213.2 ksi
layer 4	f <sub>di</sub> =	213.2 ksi
layer 5	f <sub>di</sub> =	213.2 ksi
layer 6	f <sub>di</sub> =	213.2 ksi
layer 7	f <sub>di</sub> =	213.2 ksi
layer 8	f <sub>di</sub> =	213.2 ksi
layer 9	f <sub>di</sub> =	213.2 ksi
layer 10	f <sub>di</sub> =	213.2 ksi
layer 11	f <sub>di</sub> =	213.2 ksi
layer 12	f <sub>di</sub> =	213.2 ksi
layer 13	f <sub>di</sub> =	213.2 ksi
layer 14	f <sub>di</sub> =	213.2 ksi

at service limit state (after all losses)  $\leq 0.80f_{py}$  (initial = 205.4)

layer 1 (bottom)	$f_{pe} =$	205.4 ksi
layer 2	$f_{pe} =$	205.4 ksi
layer 3	$f_{pe} =$	205.4 ksi
layer 4	$f_{pe} =$	205.4 ksi
layer 5	$f_{pe} =$	205.4 ksi
layer 6	$f_{pe} =$	205.4 ksi
layer 7	$f_{pe} =$	205.4 ksi
layer 8	$f_{pe} =$	205.4 ksi
layer 9	$f_{pe} =$	205.4 ksi
layer 10	$f_{pe} =$	205.4 ksi
layer 11	$f_{pe} =$	205.4 ksi
layer 12	$f_{pe} =$	205.4 ksi
layer 13	$f_{pe} =$	205.4 ksi
layer 14	$f_{pe} =$	205.4 ksi

Modulus of Elasticity

initial = 25898 ksi

layer 1 (bottom)	E =	25898.0 ksi
layer 2	E =	25898.0 ksi
layer 3	E =	25898.0 ksi
layer 4	E =	25898.0 ksi
layer 5	E =	25898.0 ksi
layer 6	E =	25898.0 ksi
layer 7	E =	25898.0 ksi
layer 8	E =	25898.0 ksi
layer 9	E =	25898.0 ksi
layer 10	E =	25898.0 ksi
layer 11	E =	25898.0 ksi
layer 12	E =	25898.0 ksi
layer 13	E =	25898.0 ksi
layer 14	E =	25898.0 ksi

#### MILD STEEL REINFORCING BARS

Yield Strength

Layer 1 (Bottom)	$f_y =$	60.0 ksi	68.00 °F
Layer 2 (Top)	$f_y =$	55.4 ksi	1010.00 °F

Modulus of Elasticity

Layer 1 (Bottom)	E =	29000.0 ksi
Layer 2 (Top)	E =	29000.0 ksi

Layer 1 (Bottom)

Area of steel at midspan (effective flange)	$A_{sm} =$	2.79 in <sup>2</sup>
Area of steel at endspan (effective flange)	$A_{se} =$	2.48 in <sup>2</sup>
Area of temperature and shrinkage steel (12" width)	$A_s =$	0.31 in <sup>2</sup>

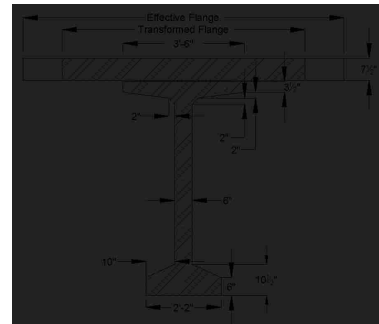
Layer 2 (Top)

Area of steel at midspan (effective flange)	$A_{sm} =$	12.6 in <sup>2</sup>
Area of steel at endspan (effective flange)	$A_{se} =$	12.4 in <sup>2</sup>
Area of temperature and shrinkage steel (12" width)	$A_s =$	0.2 in <sup>2</sup>

#### Cross-sectional Properties

##### NON-COMPOSITE BEAM

Area of cross-section of beam	A =	767.0 in <sup>2</sup>
Overall depth of beam	H =	72.0 in
Moment of Inertia	I =	539,947 in <sup>4</sup>
Distance from centroid to extreme bottom fiber	$y_b =$	36.6 in
Distance from centroid to extreme top fiber	$y_t =$	35.4 in
Section modulus for the extreme bottom fiber	$S_b =$	14915.0 in <sup>3</sup>
Section modulus for the extreme top fiber	$S_t =$	15421.0 in <sup>3</sup>
Weight	$W_t =$	799.0 plf
Modulus of Elasticity = $33000 \cdot (W_c^{1.5}) \cdot (\sqrt{f_c})$		
cast-in-place concrete deck	$E_{cs} =$	3530 ksi
precast beam at release	$E_{ci} =$	4496 ksi
precast beam at service loads	$E_c =$	5072 ksi





### COMPOSITE BEAM AT MIDSPAN

Effective Flange Width	$b_f =$	111.0 in	*min of three criteria
Modular Ratio = $E_{cs}/E_c$	$n =$	0.6959	
Transformed flange width	$=$	77.2 in	
Transformed flange area	$=$	579.3 in <sup>2</sup>	
Transformed haunch width	$=$	29.2 in	
Transformed haunch area	$=$	14.6 in <sup>2</sup>	
Deck-distance to top fiber	$y_t =$	5.14 in	

	Transformed Area	$y_b$	$Ay_b$	$A(y_{bc}-y_b)^2$	I	$I + A(y_{bc}-y_b)^2$
Beam	767.0 in <sup>2</sup>	36.60 in	28,072.2 in <sup>3</sup>	213,131 in <sup>4</sup>	539,947 in <sup>4</sup>	753,078 in <sup>4</sup>
Haunch	14.6 in <sup>2</sup>	72.25 in	1,055.9 in <sup>3</sup>	5,265 in <sup>4</sup>	0.30 in <sup>4</sup>	5,265 in <sup>4</sup>
Deck	579.3 in <sup>2</sup>	74.86 in	43,369.5 in <sup>3</sup>	270,057 in <sup>4</sup>	1,399 in <sup>4</sup>	271,456 in <sup>4</sup>
Total	1361.0 in <sup>2</sup>		72,497.6 in <sup>3</sup>			1,029,799 in <sup>4</sup>

Total area of Composite Section	$A_c =$	1361 in <sup>2</sup>
Overall Depth of the Composite Section	$h_c =$	80 in
Moment of Inertia	$I_c =$	1,029,799 in <sup>4</sup>
Distance from centroid to extreme <u>bottom</u> fiber of beam	$y_{bc} =$	53.27 in
Distance from centroid to extreme <u>top</u> fiber of beam	$y_{tg} =$	18.73 in
Distance from centroid to extreme <u>top</u> fiber of slab	$y_{tc} =$	26.73 in
Section modulus for the extreme <u>bottom</u> fiber of beam	$S_{bc} =$	19,331.8 in <sup>3</sup>
Section modulus for the extreme <u>top</u> fiber of beam	$S_{tg} =$	54,980.1 in <sup>3</sup>
Section modulus for the extreme <u>top</u> fiber slab	$S_{tc} =$	55,360.1 in <sup>3</sup>

### COMPOSITE BEAM AT ENDSPAN

Effective Flange Width	$b_f =$	106.6 in	*min of three criteria
Modular Ratio = $E_{cs}/E_c$	$n =$	0.6959	
Transformed flange width	$=$	74.2 in	
Transformed flange area	$=$	556.4 in <sup>2</sup>	
Transformed haunch width	$=$	29.2 in	
Transformed haunch area	$=$	14.6 in <sup>2</sup>	
Deck-distance to top fiber	$y_{td} =$	5.14 in	

	Transformed Area	$y_t$	$Ay_t$	$A(y_{tc}-y_t)^2$	I	$I + A(y_{tc}-y_t)^2$
Beam	767.0 in <sup>2</sup>	36.60 in	28,072.2 in <sup>3</sup>	266,924 in <sup>4</sup>	539,947 in <sup>4</sup>	806,871 in <sup>4</sup>
Haunch	14.6 in <sup>2</sup>	72.25 in	1,055.9 in <sup>3</sup>	5,086 in <sup>4</sup>	0.30 in <sup>4</sup>	5,086 in <sup>4</sup>
Deck	556.4 in <sup>2</sup>	77.64 in	43,197.1 in <sup>3</sup>	193,625 in <sup>4</sup>	1,346 in <sup>4</sup>	194,971 in <sup>4</sup>
Total	1338.0 in <sup>2</sup>		72,325.2 in <sup>3</sup>			1,006,929 in <sup>4</sup>

Total area of Composite Section	$A_c =$	1338 in <sup>2</sup>
Overall Depth of the Composite Section	$h_c =$	80 in
Moment of Inertia	$I_c =$	1,006,929 in <sup>4</sup>
Distance from centroid to extreme <u>bottom</u> fiber of beam	$y_{bc} =$	54.06 in
Distance from centroid to extreme <u>top</u> fiber of beam	$y_{tg} =$	17.94 in
Distance from centroid to extreme <u>top</u> fiber of slab	$y_{tc} =$	25.94 in
Section modulus for the extreme <u>bottom</u> fiber of beam	$S_{bc} =$	18,627.8 in <sup>3</sup>
Section modulus for the extreme <u>top</u> fiber of beam	$S_{tg} =$	56,112.1 in <sup>3</sup>
Section modulus for the extreme <u>top</u> fiber slab	$S_{tc} =$	38,810.2 in <sup>3</sup>

### Shear Forces and Bending Moments

#### DEAD LOADS

Beam self-weight	$W_{beam} =$	0.799 k/f
8 in. deck weight	$W_{deck} =$	1.200 k/f
1/2 in. haunch weight	$W_{haunch} =$	0.022 k/f

#### LRFD Specifications: Art. 4.6.2.2.1

Width of Deck Constant		OK
Number of beams is not less than four $N_b =$	4	OK
Roadway part of the overhang, $d_s \leq 3.0$ ft, $d_s =$	1.5	OK
Curvature in plans is less than 4° =	0	OK
Cross-section of the bridge is consistent with one of the cross sections given by LRFD specs		OK

Barrier and wearing surface loads are equally distributed among the 4 beams

Barrier Wt	$W_t =$	0.150 k/f
Dead load of future wearing surface	$DW =$	0.263 k/f

LIVE LOADS		
Fire truck live load front load (Point A)	$P_{live} =$	48.0 kips
Fire truck live load back load (Point B)	$P_{live} =$	22.0 kips
distance between two loads		19.2 ft
distance from nearest edge to point A	$x_a =$	59.0 ft
distance from nearest edge to point B	$x_b =$	39.8 ft
LRFD Specifications: Art. 4.6.2.2.1		
Width of Deck Constant		OK
Number of beams is not less than four $N_b =$	4	OK
Beams are parallel and approximately of the same stiffness		OK
Roadway part of the overhang, $d_s \leq 3.0$ ft, $d_e =$	1.5	OK
Curvature in plans is less than $4^\circ =$	0	OK

Barrier and wearing surface loads are equally distributed among the 4 beams

Bridge Type-- "k" (LRFD Table 4.6.2.2.1-1)		
Number of design lanes = $w/12$	=	3 lanes

#### Distribution Factor for Bending Moment:

Beams spacing	$S =$	12.0 ft
Depth of concrete slab	$t_s =$	7.5 in
Beam Span	$L =$	120.0 ft
Number of Beams	$N_b =$	4
Modular ratio between beam & deck materials	$n =$	1.4370
Longitudinal stiffness parameter	$K_g =$	2,508,620.36 in <sup>4</sup>

at center span:		
$DFM = 0.75 \left[ \left( \frac{S}{3.5} \right)^{0.1} + \left( \frac{S}{L} \right)^{0.2} + \left( \frac{K_g}{12 * L * t_s^3} \right)^{0.1} \right]$		
DFM =	0.911 lanes/beam	

0.905 Controls

one design lane loaded:		
$DFM = 0.75 + \left( \frac{S}{4} \right)^{0.4} + \left( \frac{S}{L} \right)^{0.3} + \left( \frac{K_g}{2 * L * t_s^3} \right)^{0.1}$		
DFM =	0.618 lanes/beam	

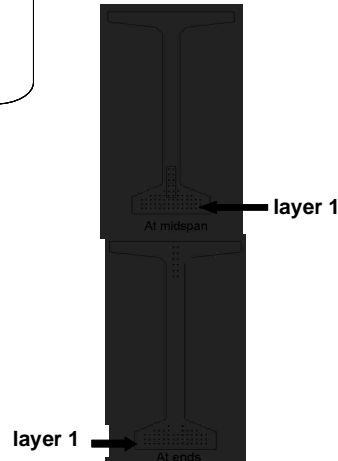
#### Distribution Factor for Shear Force

both end spans and center span:		
$DFV = 0.2 + \left( \frac{S}{12} \right) + \left( \frac{S}{35} \right)^2$		
DFV =	1.082 lanes/beam	

1.082 Controls

one design lane loaded:		
$DFV = 0.36 + \left( \frac{S}{25} \right)$		
DFV =	0.840 lanes/beam	

from bottom	At Midspan		At Ends	
	No. of	Distance from Bottom	No. of	Distance from Bottom
layer 1	14	2	14	2
layer 2	14	3.5	14	3.5
layer 3	14	5	14	5
layer 4	10	6.5	8	6.5
layer 5	4	8	2	8
layer 6	2	10	-	-
layer 7	2	12	-	-
layer 8	2	14	-	-
layer 9	2	16	2	60
layer 10	-	-	2	62
layer 11	-	-	2	64
layer 12	-	-	2	66
layer 13	-	-	2	68
layer 14	-	-	2	70
	64		64	
Harped Strand Group (included in above totals)				
layer 3	2	6		
layer 4	2	8		
layer 5	2	10		
layer 6	2	12		
layer 7	2	14		
layer 8	2	16		



distance from the center of gravity of strands to the bottom fiber of the beam = 7% of the beam depth  
strand eccentricity at midspan =  $(y_c - y_{bs})$

$y_{bs} =$	5.44 in
$e_c =$	31.16 in

### Prestress Losses

#### ELASTIC SHORTENING

assumed loss	=	6.00%
Force per strand at transfer		
layer 1	=	17.0 kips
layer 2	=	17.0 kips
layer 3	=	17.0 kips
layer 4	=	17.0 kips
layer 5	=	17.0 kips
layer 6	=	17.0 kips
layer 7	=	17.0 kips
layer 8	=	17.0 kips
layer 9	=	17.0 kips
layer 10	=	17.0 kips
layer 11	=	17.0 kips
layer 12	=	17.0 kips
layer 13	=	17.0 kips
layer 14	=	17.0 kips

Total prestressing force at release	$P_i =$	at midspan 1088.0 kips	at endspan 1054.0 kips
Sum of concrete stresses at the center of gravity of prestressing tendons due to prestressing force at transfer and the self-weight of the member at sections of maximum moment	$f_{cgp} =$	2.412 ksi	2.307 ksi
Loss due to shortening		at midspan	at endspan
layer 1	$\Delta f_{pES} =$	13.9 ksi	13.3 ksi
layer 2	$\Delta f_{pES} =$	13.9 ksi	13.3 ksi
layer 3	$\Delta f_{pES} =$	13.9 ksi	13.3 ksi
layer 4	$\Delta f_{pES} =$	13.9 ksi	13.3 ksi
layer 5	$\Delta f_{pES} =$	13.9 ksi	13.3 ksi
layer 6	$\Delta f_{pES} =$	13.9 ksi	
layer 7	$\Delta f_{pES} =$	13.9 ksi	
layer 8	$\Delta f_{pES} =$	13.9 ksi	
layer 9	$\Delta f_{pES} =$	13.9 ksi	13.3 ksi
layer 10	$\Delta f_{pES} =$		13.3 ksi
layer 11	$\Delta f_{pES} =$		13.3 ksi
layer 12	$\Delta f_{pES} =$		13.3 ksi
layer 13	$\Delta f_{pES} =$		13.3 ksi
layer 14	$\Delta f_{pES} =$		13.3 ksi

#### SHRINKAGE

Shrinkage = $(17 - 0.15 \cdot \text{Relative Humidity})$	$\Delta f_{pSR} =$	6.5 ksi	← assume relative humidity = 70%
--	--------------------	---------	----------------------------------

#### CREEP OF CONCRETE

Change of stresses at center of gravity of prestressing due to permanent loads except the loads acting at time of applying prestressing force, calculated at the same section as $f_{cgp}$	$\Delta f_{cgp} =$	1.589 ksi	
loss due to creep	$\Delta f_{pCR} =$	at midspan 17.8 ksi	at endspan 16.6 ksi

**RELAXATION OF PRESTRESSING STRANDS**

loss due to relaxation after transfer		at midspan	at endspan
layer 1	$\Delta f_{PR2} =$	2.9 ksi	2.9 ksi
layer 2	$\Delta f_{PR2} =$	2.9 ksi	2.9 ksi
layer 3	$\Delta f_{PR2} =$	2.9 ksi	2.9 ksi
layer 4	$\Delta f_{PR2} =$	2.9 ksi	2.9 ksi
layer 5	$\Delta f_{PR2} =$	2.9 ksi	2.9 ksi
layer 6	$\Delta f_{PR2} =$	2.9 ksi	
layer 7	$\Delta f_{PR2} =$	2.9 ksi	
layer 8	$\Delta f_{PR2} =$	2.9 ksi	
layer 9	$\Delta f_{PR2} =$	2.9 ksi	2.9 ksi
layer 10	$\Delta f_{PR2} =$		2.9 ksi
layer 11	$\Delta f_{PR2} =$		2.9 ksi
layer 12	$\Delta f_{PR2} =$		2.9 ksi
layer 13	$\Delta f_{PR2} =$		2.9 ksi
layer 14	$\Delta f_{PR2} =$		2.9 ksi

**TOTAL LOSSES AT TRANSFER**

total loss  $\Delta f_{pES} = \Delta f_{pl}$

stress in tendons after transfer  $f_{pt} = f_{pr} - \Delta f_{pl}$

		at midspan	at endspan
layer 1	$f_{pt} =$	199.3 ksi	199.9 ksi
layer 2	$f_{pt} =$	199.3 ksi	199.9 ksi
layer 3	$f_{pt} =$	199.3 ksi	199.9 ksi
layer 4	$f_{pt} =$	199.3 ksi	199.9 ksi
layer 5	$f_{pt} =$	199.3 ksi	199.9 ksi
layer 6	$f_{pt} =$	199.3 ksi	
layer 7	$f_{pt} =$	199.3 ksi	
layer 8	$f_{pt} =$	199.3 ksi	
layer 9	$f_{pt} =$	199.3 ksi	199.9 ksi
layer 10	$f_{pt} =$		199.9 ksi
layer 11	$f_{pt} =$		199.9 ksi
layer 12	$f_{pt} =$		199.9 ksi
layer 13	$f_{pt} =$		199.9 ksi
layer 14	$f_{pt} =$		199.9 ksi

force per strand =  $f_{pt} \cdot \text{strand area}$

		at midspan	at endspan
layer 1	=	16.9 kips	17.0 kips
layer 2	=	16.9 kips	17.0 kips
layer 3	=	16.9 kips	17.0 kips
layer 4	=	16.9 kips	17.0 kips
layer 5	=	16.9 kips	17.0 kips
layer 6	=	16.9 kips	
layer 7	=	16.9 kips	
layer 8	=	16.9 kips	
layer 9	=	16.9 kips	17.0 kips
layer 10	=		17.0 kips
layer 11	=		17.0 kips
layer 12	=		17.0 kips
layer 13	=		17.0 kips
layer 14	=		17.0 kips

Total prestressing force after transfer

Initial loss =  $(\Delta f_{pl}) / (f_{pi})$

		at midspan	at endspan
layer 1	% =	6.5%	6.2%
layer 2	% =	6.5%	6.2%
layer 3	% =	6.5%	6.2%
layer 4	% =	6.5%	6.2%
layer 5	% =	6.5%	6.2%
layer 6	% =	6.5%	
layer 7	% =	6.5%	
layer 8	% =	6.5%	
layer 9	% =	6.5%	6.2%
layer 10	% =		6.2%
layer 11	% =		6.2%
layer 12	% =		6.2%
layer 13	% =		6.2%
layer 14	% =		6.2%

OK  
OK  
OK  
OK  
OK  
OK  
OK  
OK  
OK  
OK  
OK  
OK  
OK  
OK

**TOTAL LOSSES AT SERVICE LOADS**

Total Losses		at midspan	at endspan
layer 1	$\Delta f_{pT} =$	41.1 ksi	40.5 ksi
layer 2	$\Delta f_{pT} =$	41.1 ksi	40.5 ksi
layer 3	$\Delta f_{pT} =$	41.1 ksi	40.5 ksi
layer 4	$\Delta f_{pT} =$	41.1 ksi	40.5 ksi
layer 5	$\Delta f_{pT} =$	41.1 ksi	40.5 ksi
layer 6	$\Delta f_{pT} =$	41.1 ksi	
layer 7	$\Delta f_{pT} =$	41.1 ksi	
layer 8	$\Delta f_{pT} =$	41.1 ksi	
layer 9	$\Delta f_{pT} =$	41.1 ksi	40.5 ksi
layer 10	$\Delta f_{pT} =$		40.5 ksi
layer 11	$\Delta f_{pT} =$		40.5 ksi
layer 12	$\Delta f_{pT} =$		40.5 ksi
layer 13	$\Delta f_{pT} =$		40.5 ksi
layer 14	$\Delta f_{pT} =$		40.5 ksi

Stress in tendon after all losses = $f_{pi} - \Delta f_{pi}$		at midspan	at endspan
layer 1	$f_{pe} =$	172.1 ksi	172.7 ksi
layer 2	$f_{pe} =$	172.1 ksi	172.7 ksi
layer 3	$f_{pe} =$	172.1 ksi	172.7 ksi
layer 4	$f_{pe} =$	172.1 ksi	172.7 ksi
layer 5	$f_{pe} =$	172.1 ksi	172.7 ksi
layer 6	$f_{pe} =$	172.1 ksi	
layer 7	$f_{pe} =$	172.1 ksi	
layer 8	$f_{pe} =$	172.1 ksi	
layer 9	$f_{pe} =$	172.1 ksi	172.7 ksi
layer 10	$f_{pe} =$		172.7 ksi
layer 11	$f_{pe} =$		172.7 ksi
layer 12	$f_{pe} =$		172.7 ksi
layer 13	$f_{pe} =$		172.7 ksi
layer 14	$f_{pe} =$		172.7 ksi

check prestressing stress limit at service limit state:  $f_{pe} \leq 0.8 \cdot f_{py}$

layer 1	=	205.4 ksi
layer 2	=	205.4 ksi
layer 3	=	205.4 ksi
layer 4	=	205.4 ksi
layer 5	=	205.4 ksi
layer 6	=	205.4 ksi
layer 7	=	205.4 ksi
layer 8	=	205.4 ksi
layer 9	=	205.4 ksi
layer 10	=	205.4 ksi
layer 11	=	205.4 ksi
layer 12	=	205.4 ksi
layer 13	=	205.4 ksi
layer 14	=	205.4 ksi

OK  
OK  
OK  
OK  
OK  
OK  
OK  
OK  
OK  
OK  
OK  
OK  
OK  
OK

force per strand =  $f_{pe} \cdot \text{strand area}$

		at midspan	at endspan
layer 1	=	14.6 kips	14.7 kips
layer 2	=	14.6 kips	14.7 kips
layer 3	=	14.6 kips	14.7 kips
layer 4	=	14.6 kips	14.7 kips
layer 5	=	14.6 kips	14.7 kips
layer 6	=	14.6 kips	
layer 7	=	14.6 kips	
layer 8	=	14.6 kips	
layer 9	=	14.6 kips	14.7 kips
layer 10	=		14.7 kips
layer 11	=		14.7 kips
layer 12	=		14.7 kips
layer 13	=		14.7 kips
layer 14	=		14.7 kips

		at midspan	at endspan
Total prestressing force after all losses	$P_{pe} =$	936.0 kips	939.3 kips
Final losses, % = $(\Delta f_{pT})/f_{pi}$			
layer 1	% =	19.3%	19.0%
layer 2	% =	19.3%	19.0%
layer 3	% =	19.3%	19.0%
layer 4	% =	19.3%	19.0%
layer 5	% =	19.3%	19.0%
layer 6	% =	19.3%	
layer 7	% =	19.3%	
layer 8	% =	19.3%	
layer 9	% =	19.3%	19.0%
layer 10	% =		19.0%
layer 11	% =		19.0%
layer 12	% =		19.0%
layer 13	% =		19.0%
layer 14	% =		19.0%
Average final losses, %	% =	19.3%	19.0%

### Stresses at Transfer

#### STRESS LIMITS FOR CONCRETE

Compression = $0.6f'_{ci}$	$f_{ci} =$	3.300 ksi
Tension		
without bonded reinforcement = $-0.0948\sqrt{f'_{ci}} \leq -0.2$	=	-0.200 ksi
with bonded auxiliary reinforcement = $-0.22\sqrt{f'_{ci}}$	=	-0.016 ksi

#### STRESSES AT TRANSFER LENGTH SECTION

Transfer Length = $60 \times (\text{strand diameter})$	=	1.9 ft	} Calcs for eccentricity (see 9.6.7.2)
Bending moment at transfer length	$M_g =$	87.7 ft-kips	
center of 12 strands to top fiber of beam at the end	=	7.00 in	
center of 12 strands to bottom fiber of beam at the harp point	=	11.00 in	
center of 12 strands and top fiber of beam at transfer length	=	9.84 in	
center of gravity of 32 strands and bottom fiber of beam	=	3.98 in	
center of gravity of all strands and the bottom fiber of beam at transfer length	=	15.24 in	
center of gravity of all strands and the bottom fiber of beam at the end	=	15.30 in	
Eccentricity of the strand group at transfer length:	$e_h =$	21.36 in	}
Eccentricity at end of beam:	$e =$	21.30 in	

$$f_t = \frac{P_i}{A} - \frac{P_i e}{S_t} + \frac{M_g}{S_t}$$

$$f_b = \frac{P_i}{A} + \frac{P_i e}{S_b} - \frac{M_g}{S_b}$$

		at midspan	at endspan	
Top stress at top fiber of beam	$f_t =$	-0.017 ksi	-0.017 ksi	OK
Bottom stress at bottom fiber of the beam	$f_b =$	2.906 ksi	2.906 ksi	OK

#### STRESSES AT HARP POINT

Bending moment due to beam weight at 0.3L	$M_g =$	1188.0 ft-kips		
Top stress at top fiber of beam	$f_t =$	0.173 ksi	0.169 ksi	OK
Bottom stress at bottom fiber of the beam	$f_b =$	2.736 ksi	2.621 ksi	OK

#### STRESSES AT MIDSPAN

Bending moment due to beam weight at 0.5L	$M_g =$	1414.3 ft-kips		
Top stress at top fiber of beam	$f_t =$	0.320 ksi	0.345 ksi	OK
Bottom stress at bottom fiber of the beam	$f_b =$	2.554 ksi	2.438 ksi	OK

#### HOLD-DOWN FORCES

assume stress in strand before losses =  $0.8f_u$

layer 1	=	227.4 ksi
layer 2	=	227.4 ksi
layer 3	=	227.4 ksi
layer 4	=	227.4 ksi
layer 5	=	227.4 ksi
layer 6	=	227.4 ksi
layer 7	=	227.4 ksi
layer 8	=	227.4 ksi
layer 9	=	227.4 ksi
layer 10	=	227.4 ksi
layer 11	=	227.4 ksi
layer 12	=	227.4 ksi
layer 13	=	227.4 ksi
layer 14	=	227.4 ksi

prestress force per strand before any losses:

layer 1	=	19.3 kips
layer 2	=	19.3 kips
layer 3	=	19.3 kips
layer 4	=	19.3 kips
layer 5	=	19.3 kips
layer 6	=	19.3 kips
layer 7	=	19.3 kips
layer 8	=	19.3 kips
layer 9	=	19.3 kips
layer 10	=	19.3 kips
layer 11	=	19.3 kips
layer 12	=	19.3 kips
layer 13	=	19.3 kips
layer 14	=	19.3 kips
Harp Angle	$\psi$ =	7.2 °

Hold-down force/strand

layer 1	=	2.5 kips/strand
layer 2	=	2.5 kips/strand
layer 3	=	2.5 kips/strand
layer 4	=	2.5 kips/strand
layer 5	=	2.5 kips/strand
layer 6	=	2.5 kips/strand
layer 7	=	2.5 kips/strand
layer 8	=	2.5 kips/strand
layer 9	=	2.5 kips/strand
layer 10	=	2.5 kips/strand
layer 11	=	2.5 kips/strand
layer 12	=	2.5 kips/strand
layer 13	=	2.5 kips/strand
layer 14	=	2.5 kips/strand
Total hold-down force	=	30.45 kips

### Stresses at Service Loads

#### STRESS LIMITS FOR CONCRETE

Compression:

Due to permanent loads for load combination Service I

for the precast beam	=	3.150 ksi
for deck	=	1.526 ksi

Due to permanent and transient loads for load combination Service I

for the precast beam	=	4.200 ksi
for deck	=	2.034 ksi

Tension:

Load Combination Service III

for the precast beam	=	-0.016 ksi
----------------------	---	------------

#### STRESSES AT MIDSPAN

Compression stresses at top fiber of beam	at midspan	at endspan		
$f_1 = \frac{P_{pe}}{A} - \frac{P_{pe}e}{S_1} + \frac{(M_w + M_d)}{S_t} + \frac{(M_w + M_b)}{S_{tg}}$	$f_{1g} =$	2.110 ksi	2.108 ksi	OK
Due to permanent loads				
$f_{1g} = \frac{P_M}{A} - \frac{P_{pe}e}{S_1} + \frac{(M_w + M_d)}{S_t} + \frac{(M_w - M_b)}{S_{tg}} + \frac{(M_{LL+I})}{S_{tg}}$	$f_{1g} =$	2.572 ksi	2.569 ksi	OK
Due to permanent loads and transient loads				
<b>Compression stresses at top fiber of deck</b>	<b>at midspan</b>	<b>at endspan</b>		
$f_{1g} = \frac{(M_w + M_b)}{S_{tc}}$	$f_{1g} =$	0.044 ksi	0.044 ksi	OK
Due to permanent loads				
$f_{1g} = \frac{(M_w + M_b + M_{LL+I})}{S_{tc}}$	$f_{1g} =$	0.502 ksi	0.502 ksi	OK
Due to permanent loads and transient loads				
<b>Tension stresses at top fiber of deck</b>	<b>at midspan</b>	<b>at endspan</b>		
$f_{1g} = \frac{P_{pe}}{A} + \frac{P_{pe}e}{S_b} - \frac{(M_w + M_d)}{S_b} - \frac{(M_w + M_b + 0.5 * M_{LL+I})}{S_{br}}$	$f_{1g} =$	-0.829 ksi	-0.818 ksi	OK
Load Combination Service III				

**Strength Limit State**

POSITIVE MOMENT SECTION		
$M_u = 1.25DC+1.5DW+1.75(LL+IM)$	$M_u =$	8381.5 ft-kips

effective length factor for compression members

layer 1	k =	0.27
layer 2	k =	0.27
layer 3	k =	0.27
layer 4	k =	0.27
layer 5	k =	0.27
layer 6	k =	0.27
layer 7	k =	0.27
layer 8	k =	0.27
layer 9	k =	0.27
layer 10	k =	0.27
layer 11	k =	0.27
layer 12	k =	0.27
layer 13	k =	0.27
layer 14	k =	0.27
	c =	5.4 ft-kips

average stress in prestressing steel

layer 1	$f_{ps} =$	278.6 ksi
layer 2	$f_{ps} =$	278.6 ksi
layer 3	$f_{ps} =$	278.6 ksi
layer 4	$f_{ps} =$	278.6 ksi
layer 5	$f_{ps} =$	278.6 ksi
layer 6	$f_{ps} =$	278.6 ksi
layer 7	$f_{ps} =$	278.6 ksi
layer 8	$f_{ps} =$	278.6 ksi
layer 9	$f_{ps} =$	278.6 ksi
layer 10	$f_{ps} =$	278.6 ksi
layer 11	$f_{ps} =$	278.6 ksi
layer 12	$f_{ps} =$	278.6 ksi
layer 13	$f_{ps} =$	278.6 ksi
layer 14	$f_{ps} =$	278.6 ksi

nominal flexure resistance

	a =	4.61 in
$M_r = \Phi M_n, \Phi = 1.00$	$\Phi M_n =$	9125.1 ft-kips
M=DC+W+LL+IM	M =	5833.6 ft-kips

OK

OK

NEGATIVE MOMENT SECTION		
$M_u = 1.25DC+1.5DW+1.75(LL+IM)$	$M_u =$	-4837.2 ft-kips

	a =	5.60 in
	$\Phi M_n =$	4606.8 ft-kips
M=DC+W+LL+IM	M =	-2869.7 ft-kips

NOT OK

OK



### Shear Design

CRITICAL SECTION AT 0.59		
$V_u = 1.25DC + 1.5DW + 1.75(LL + IM)$	$V_u =$	405.0 kips
$M_u = 1.25DC + 1.5DW + 1.75(LL + IM)$	$M_u =$	-2684.4 ft-kips
or		
$V_u = 1.25DC + 1.5DW + 1.75(LL + IM)$	$V_u =$	364.8 kips
$M_u = 1.25DC + 1.5DW + 1.75(LL + IM)$	$M_u =$	-2877.0 ft-kips
max shear	$V_u =$	405.0 kips
max moment	$M_u =$	2877.0 ft-kips
Shear depth	$d_v =$	73.19 in
Applied factored normal force at the section	$N_u =$	0
Angle of diagonal compressive stresses	$\theta =$	36.00 °

### STRAIN IN FLEXURAL TENSION REINFORCEMENT

$$\epsilon_x = \frac{\frac{M_u}{d_v} + 0.5N_u \cot \theta + A_{ps} f_{ps}}{E_s A_s + E_p A_{ps}} \leq 0.002$$

	at midspan	at endspan
resultant compressive stress at centroid	$f_{pc} =$ 0.933 ksi	0.935 ksi

effective stress in prestressing strand after all losses

	at midspan	at endspan
layer 1	$f_{po} =$ 176.8 ksi	177.4 ksi
layer 2	$f_{po} =$ 176.8 ksi	177.4 ksi
layer 3	$f_{po} =$ 176.8 ksi	177.4 ksi
layer 4	$f_{po} =$ 176.8 ksi	177.4 ksi
layer 5	$f_{po} =$ 176.8 ksi	
layer 6	$f_{po} =$ 176.8 ksi	
layer 7	$f_{po} =$ 176.8 ksi	
layer 8	$f_{po} =$ 176.8 ksi	
layer 9	$f_{po} =$	177.4 ksi
layer 10	$f_{po} =$	177.4 ksi
layer 11	$f_{po} =$	177.4 ksi
layer 12	$f_{po} =$	177.4 ksi
layer 13	$f_{po} =$	177.4 ksi
layer 14	$f_{po} =$	177.4 ksi

strain in flexural tension

	at midspan	at endspan
layer 1	$\epsilon_x =$ 0.002000	0.002000
layer 2	$\epsilon_x =$ 0.002000	0.002000
layer 3	$\epsilon_x =$ 0.002000	0.002000
layer 4	$\epsilon_x =$ 0.002000	0.002000
layer 5	$\epsilon_x =$ 0.002000	
layer 6	$\epsilon_x =$ 0.002000	
layer 7	$\epsilon_x =$ 0.002000	
layer 8	$\epsilon_x =$ 0.002000	
layer 9	$\epsilon_x =$	0.002000
layer 10	$\epsilon_x =$	0.002000
layer 11	$\epsilon_x =$	0.002000
layer 12	$\epsilon_x =$	0.002000
layer 13	$\epsilon_x =$	0.002000
layer 14	$\epsilon_x =$	0.002000

### Deflection and Camber

	at midspan	at endspan
Deflection due to Prestressing Force at Transfer	$\Delta_p =$ 3.27 in	3.29 in
Deflection due to Beam Self-Weight at Transfer	$\Delta_g =$ -1.49 in	
Deflection due to Beam Self-Weight at Erection	$\Delta_g =$ -1.44 in	
Deflection due to Haunch and Deck	$\Delta_s =$ -1.95 in	

Deflection due to total self weight

$\Delta_{sw} =$	-0.11 in
-----------------	----------

Total Deflection at transfer

$\Delta =$	1.79 in	1.81 in
------------	---------	---------

Total Deflection at erection

$\Delta =$	3.24 in	3.27 in
------------	---------	---------

Live load deflection limit = span/800

$=$	1.80 in
-----	---------

Deflection due to live load and impact

$\Delta_L =$	-0.86 in
--------------	----------

OK

Deflection due to fire truck

$\Delta_L =$	-0.7747 in
--------------	------------

OK

Total Deflection after fire with fire truck

$\Delta =$	2.3901 in
------------	-----------

**Location: Fire at Critical Negative Moment Sections**  
**Beam Design: 3/8" Strand**  
**Fire Exposure Status: 2 Hour**

(PCI Bridge Design Manual Section 9.6)

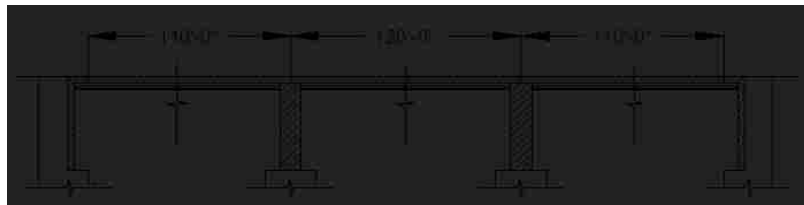


**Material Properties**

CAST-IN-PLACE SLAB		
Actual Thickness	$t_{as} =$	8.0 in
Wearing Surface	$=$	0.5 in
Structural thickness = Actual - Wearing Surface	$t_s =$	7.5 in
Compressive Strength	$f'_c =$	3.25 ksi
Unit Weight	$w_c =$	150.0 pcf
Stress factor of compression block	$\beta_1 =$	0.85

BEAMS: AASHTO-PCI, BT-72 BULB-TEE		
Strength at release	$f'_{ci} =$	5.5 ksi
Strength at 28 days	$f'_c =$	7 ksi
Unit Weight	$w_c =$	150.0 pcf
Overall Beam Length:		
@ end spans	$L =$	110 ft
@ center span	$L =$	119 ft
Design Spans:		
Non-composite beam @ end spans	$L =$	109 ft
Non-composite beam @ center span	$L =$	118 ft
Composite beam @ end spans	$L =$	110 ft
Composite beam @ center span	$L =$	120 ft
Beam Spacing	$S =$	12 ft



**PRESTRESSING STRANDS**

Diameter of single strand	d =	0.4 in
Area of single strand	A =	0.085 in <sup>2</sup>

Temperature of Layer

layer 1 (bottom)	T =	68.00 °F
layer 2	T =	68.00 °F
layer 3	T =	68.00 °F
layer 4	T =	68.00 °F
layer 5	T =	68.00 °F
layer 6	T =	68.00 °F
layer 7	T =	68.00 °F
layer 8	T =	68.00 °F
layer 9	T =	68.00 °F
layer 10	T =	68.00 °F
layer 11	T =	68.00 °F
layer 12	T =	68.00 °F
layer 13	T =	68.00 °F
layer 14	T =	68.00 °F

Ultimate Strength

initial = 284 ksi

layer 1 (bottom)	f <sub>pu</sub> =	284 ksi
layer 2	f <sub>pu</sub> =	284 ksi
layer 3	f <sub>pu</sub> =	284 ksi
layer 4	f <sub>pu</sub> =	284 ksi
layer 5	f <sub>pu</sub> =	284 ksi
layer 6	f <sub>pu</sub> =	284 ksi
layer 7	f <sub>pu</sub> =	284 ksi
layer 8	f <sub>pu</sub> =	284 ksi
layer 9	f <sub>pu</sub> =	284 ksi
layer 10	f <sub>pu</sub> =	284 ksi
layer 11	f <sub>pu</sub> =	284 ksi
layer 12	f <sub>pu</sub> =	284 ksi
layer 13	f <sub>pu</sub> =	284 ksi
layer 14	f <sub>pu</sub> =	284 ksi

Yield Strength

initial = 257 ksi

layer 1 (bottom)	f <sub>py</sub> =	257 ksi
layer 2	f <sub>py</sub> =	257 ksi
layer 3	f <sub>py</sub> =	257 ksi
layer 4	f <sub>py</sub> =	257 ksi
layer 5	f <sub>py</sub> =	257 ksi
layer 6	f <sub>py</sub> =	257 ksi
layer 7	f <sub>py</sub> =	257 ksi
layer 8	f <sub>py</sub> =	257 ksi
layer 9	f <sub>py</sub> =	257 ksi
layer 10	f <sub>py</sub> =	257 ksi
layer 11	f <sub>py</sub> =	257 ksi
layer 12	f <sub>py</sub> =	257 ksi
layer 13	f <sub>py</sub> =	257 ksi
layer 14	f <sub>py</sub> =	257 ksi

**Stress Limits:**

before transfer ≤ 0.75f<sub>pu</sub> (initial = 213.2)

layer 1 (bottom)	f <sub>di</sub> =	213.2 ksi
layer 2	f <sub>di</sub> =	213.2 ksi
layer 3	f <sub>di</sub> =	213.2 ksi
layer 4	f <sub>di</sub> =	213.2 ksi
layer 5	f <sub>di</sub> =	213.2 ksi
layer 6	f <sub>di</sub> =	213.2 ksi
layer 7	f <sub>di</sub> =	213.2 ksi
layer 8	f <sub>di</sub> =	213.2 ksi
layer 9	f <sub>di</sub> =	213.2 ksi
layer 10	f <sub>di</sub> =	213.2 ksi
layer 11	f <sub>di</sub> =	213.2 ksi
layer 12	f <sub>di</sub> =	213.2 ksi
layer 13	f <sub>di</sub> =	213.2 ksi
layer 14	f <sub>di</sub> =	213.2 ksi

at service limit state (after all losses)  $\leq 0.80f_{py}$  (initial = 205.4)

layer 1 (bottom)	$f_{pe} =$	205.4 ksi
layer 2	$f_{pe} =$	205.4 ksi
layer 3	$f_{pe} =$	205.4 ksi
layer 4	$f_{pe} =$	205.4 ksi
layer 5	$f_{pe} =$	205.4 ksi
layer 6	$f_{pe} =$	205.4 ksi
layer 7	$f_{pe} =$	205.4 ksi
layer 8	$f_{pe} =$	205.4 ksi
layer 9	$f_{pe} =$	205.4 ksi
layer 10	$f_{pe} =$	205.4 ksi
layer 11	$f_{pe} =$	205.4 ksi
layer 12	$f_{pe} =$	205.4 ksi
layer 13	$f_{pe} =$	205.4 ksi
layer 14	$f_{pe} =$	205.4 ksi

Modulus of Elasticity

initial = 25898 ksi

layer 1 (bottom)	E =	25898.0 ksi
layer 2	E =	25898.0 ksi
layer 3	E =	25898.0 ksi
layer 4	E =	25898.0 ksi
layer 5	E =	25898.0 ksi
layer 6	E =	25898.0 ksi
layer 7	E =	25898.0 ksi
layer 8	E =	25898.0 ksi
layer 9	E =	25898.0 ksi
layer 10	E =	25898.0 ksi
layer 11	E =	25898.0 ksi
layer 12	E =	25898.0 ksi
layer 13	E =	25898.0 ksi
layer 14	E =	25898.0 ksi

#### MILD STEEL REINFORCING BARS

Yield Strength

Layer 1 (Bottom)	$f_y =$	60.0 ksi	68.00 °F
Layer 2 (Top)	$f_y =$	53.3 ksi	1120.00 °F

Modulus of Elasticity

Layer 1 (Bottom)	E =	29000.0 ksi
Layer 2 (Top)	E =	29000.0 ksi

Layer 1 (Bottom)

Area of steel at midspan (effective flange)	$A_{sm} =$	2.79 in <sup>2</sup>
Area of steel at endspan (effective flange)	$A_{se} =$	2.48 in <sup>2</sup>
Area of temperature and shrinkage steel (12" width)	$A_{st} =$	0.31 in <sup>2</sup>

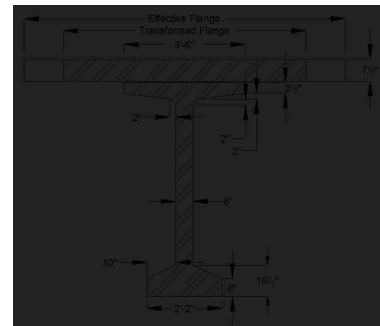
Layer 2 (Top)

Area of steel at midspan (effective flange)	$A_{sm} =$	12.6 in <sup>2</sup>
Area of steel at endspan (effective flange)	$A_{se} =$	12.4 in <sup>2</sup>
Area of temperature and shrinkage steel (12" width)	$A_{st} =$	0.2 in <sup>2</sup>

#### Cross-sectional Properties

##### NON-COMPOSITE BEAM

Area of cross-section of beam	A =	767.0 in <sup>2</sup>
Overall depth of beam	H =	72.0 in
Moment of Inertia	I =	539,947 in <sup>4</sup>
Distance from centroid to extreme bottom fiber	$y_b =$	36.6 in
Distance from centroid to extreme top fiber	$y_t =$	35.4 in
Section modulus for the extreme bottom fiber	$S_b =$	14915.0 in <sup>3</sup>
Section modulus for the extreme top fiber	$S_t =$	15421.0 in <sup>3</sup>
Weight	$W_t =$	799.0 plf
Modulus of Elasticity = $33000 \cdot (W_c^{1.5}) \cdot (\sqrt{f_c})$		
cast-in-place concrete deck	$E_{cs} =$	3456 ksi
precast beam at release	$E_{ci} =$	4496 ksi
precast beam at service loads	$E_c =$	5072 ksi



### COMPOSITE BEAM AT MIDSPAN

Effective Flange Width	$b_f =$	111.0 in	*min of three criteria
Modular Ratio = $E_{cs}/E_c$	$n =$	0.6814	
Transformed flange width	$=$	75.6 in	
Transformed flange area	$=$	567.3 in <sup>2</sup>	
Transformed haunch width	$=$	28.6 in	
Transformed haunch area	$=$	14.3 in <sup>2</sup>	
Deck-distance to top fiber	$y_t =$	5.34 in	

	Transformed Area	$y_b$	$Ay_b$	$A(y_{bc}-y_b)^2$	$I$	$I + A(y_{bc}-y_b)^2$
Beam	767.0 in <sup>2</sup>	36.60 in	28,072.2 in <sup>3</sup>	205,982 in <sup>4</sup>	539,947 in <sup>4</sup>	745,929 in <sup>4</sup>
Haunch	14.3 in <sup>2</sup>	72.25 in	1,033.8 in <sup>3</sup>	5,309 in <sup>4</sup>	0.30 in <sup>4</sup>	5,310 in <sup>4</sup>
Deck	567.3 in <sup>2</sup>	74.66 in	42,351.1 in <sup>3</sup>	266,433 in <sup>4</sup>	1,163 in <sup>4</sup>	267,597 in <sup>4</sup>
Total	1348.6 in <sup>2</sup>		71,457.2 in <sup>3</sup>			1,018,835 in <sup>4</sup>

Total area of Composite Section	$A_c =$	1349 in <sup>2</sup>
Overall Depth of the Composite Section	$h_c =$	80 in
Moment of Inertia	$I_c =$	1,018,835 in <sup>4</sup>
Distance from centroid to extreme <u>bottom</u> fiber of beam	$y_{bc} =$	52.99 in
Distance from centroid to extreme <u>top</u> fiber of beam	$y_{tg} =$	19.01 in
Distance from centroid to extreme <u>top</u> fiber of slab	$y_{tc} =$	27.01 in
Section modulus for the extreme <u>bottom</u> fiber of beam	$S_{bc} =$	19,227.8 in <sup>3</sup>
Section modulus for the extreme <u>top</u> fiber of beam	$S_{tg} =$	53,588.1 in <sup>3</sup>
Section modulus for the extreme <u>top</u> fiber slab	$S_{tc} =$	55,354.0 in <sup>3</sup>

### COMPOSITE BEAM AT ENDSPAN

Effective Flange Width	$b_f =$	106.6 in	*min of three criteria
Modular Ratio = $E_{cs}/E_c$	$n =$	0.6814	
Transformed flange width	$=$	72.6 in	
Transformed flange area	$=$	544.8 in <sup>2</sup>	
Transformed haunch width	$=$	28.6 in	
Transformed haunch area	$=$	14.3 in <sup>2</sup>	
Deck-distance to top fiber	$y_{td} =$	5.34 in	

	Transformed Area	$y_t$	$Ay_t$	$A(y_{tc}-y_t)^2$	$I$	$I + A(y_{tc}-y_t)^2$
Beam	767.0 in <sup>2</sup>	36.60 in	28,072.2 in <sup>3</sup>	263,260 in <sup>4</sup>	539,947 in <sup>4</sup>	803,207 in <sup>4</sup>
Haunch	14.3 in <sup>2</sup>	72.25 in	1,033.8 in <sup>3</sup>	4,911 in <sup>4</sup>	0.30 in <sup>4</sup>	4,912 in <sup>4</sup>
Deck	544.8 in <sup>2</sup>	77.84 in	42,404.7 in <sup>3</sup>	186,982 in <sup>4</sup>	1,119 in <sup>4</sup>	188,101 in <sup>4</sup>
Total	1326.1 in <sup>2</sup>		71,510.7 in <sup>3</sup>			996,220 in <sup>4</sup>

Total area of Composite Section	$A_c =$	1326 in <sup>2</sup>
Overall Depth of the Composite Section	$h_c =$	80 in
Moment of Inertia	$I_c =$	996,220 in <sup>4</sup>
Distance from centroid to extreme <u>bottom</u> fiber of beam	$y_{bc} =$	53.93 in
Distance from centroid to extreme <u>top</u> fiber of beam	$y_{tg} =$	18.07 in
Distance from centroid to extreme <u>top</u> fiber of slab	$y_{tc} =$	26.07 in
Section modulus for the extreme <u>bottom</u> fiber of beam	$S_{bc} =$	18,473.6 in <sup>3</sup>
Section modulus for the extreme <u>top</u> fiber of beam	$S_{tg} =$	55,120.6 in <sup>3</sup>
Section modulus for the extreme <u>top</u> fiber slab	$S_{tc} =$	38,208.2 in <sup>3</sup>

### Shear Forces and Bending Moments

#### DEAD LOADS

Beam self-weight	$W_{beam} =$	0.799 k/f
8 in. deck weight	$W_{deck} =$	1.200 k/f
1/2 in. haunch weight	$W_{haunch} =$	0.022 k/f

#### LRFD Specifications: Art. 4.6.2.2.1

Width of Deck Constant		OK
Number of beams is not less than four $N_b =$	4	OK
Roadway part of the overhang, $d_s \leq 3.0$ ft, $d_s =$	1.5	OK
Curvature in plans is less than 4° =	0	OK
Cross-section of the bridge is consistent with one of the cross sections given by LRFD specs		OK

Barrier and wearing surface loads are equally distributed among the 4 beams

Barrier Wt	$W_t =$	0.150 k/f
Dead load of future wearing surface	$DW =$	0.263 k/f

LIVE LOADS		
Fire truck live load front load (Point A)	$P_{live} =$	48.0 kips
Fire truck live load back load (Point B)	$P_{live} =$	22.0 kips
distance between two loads		19.2 ft
distance from nearest edge to point A	$x_a =$	59.0 ft
distance from nearest edge to point B	$x_b =$	39.8 ft
LRFD Specifications: Art. 4.6.2.2.1		
Width of Deck Constant		OK
Number of beams is not less than four $N_b =$	4	OK
Beams are parallel and approximately of the same stiffness		OK
Roadway part of the overhang, $d_s \leq 3.0$ ft, $d_e =$	1.5	OK
Curvature in plans is less than $4^\circ =$	0	OK

Barrier and wearing surface loads are equally distributed among the 4 beams

Bridge Type-- "k" (LRFD Table 4.6.2.2.1-1)		
Number of design lanes = $w/12$	=	3 lanes

#### Distribution Factor for Bending Moment:

Beams spacing	$S =$	12.0 ft
Depth of concrete slab	$t_s =$	7.5 in
Beam Span	$L =$	120.0 ft
Number of Beams	$N_b =$	4
Modular ratio between beam & deck materials	$n =$	1.4676
Longitudinal stiffness parameter	$K_g =$	2,562,082.51 in <sup>4</sup>

at center span:		
$DFM = 0.75 \left[ \left( \frac{S}{3.5} \right)^{0.1} + \left( \frac{S}{L} \right)^{0.2} + \left( \frac{K_g}{12 * L * t_s^3} \right)^{0.1} \right]$		
DFM =		0.913 lanes/beam

0.905 Controls

one design lane loaded:		
$DFM = 0.75 + \left( \frac{S}{4} \right)^{0.4} + \left( \frac{S}{L} \right)^{0.3} + \left( \frac{K_g}{2 * L * t_s^3} \right)^{0.1}$		
DFM =		0.619 lanes/beam

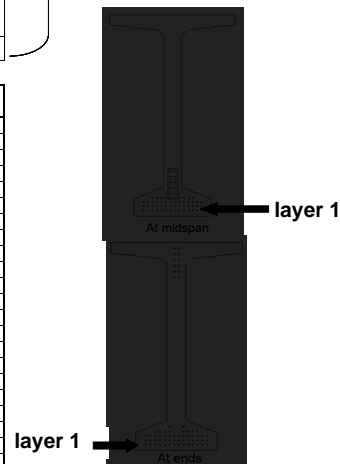
#### Distribution Factor for Shear Force

both end spans and center span:		
$DFV = 0.2 + \left( \frac{S}{12} \right) - \left( \frac{S}{35} \right)^2$		
DFV =		1.082 lanes/beam

1.082 Controls

one design lane loaded:		
$DFV = 0.36 + \left( \frac{S}{25} \right)$		
DFV =		0.840 lanes/beam

from bottom	At Midspan		At Ends	
	No. of	Distance from Bottom	No. of	Distance from Bottom
layer 1	14	2	14	2
layer 2	14	3.5	14	3.5
layer 3	14	5	14	5
layer 4	10	6.5	8	6.5
layer 5	4	8	2	8
layer 6	2	10	-	-
layer 7	2	12	-	-
layer 8	2	14	-	-
layer 9	2	16	2	60
layer 10	-	-	2	62
layer 11	-	-	2	64
layer 12	-	-	2	66
layer 13	-	-	2	68
layer 14	-	-	2	70
	64		64	
<b>Harped Strand Group (included in above totals)</b>				
layer 3	2	6		
layer 4	2	8		
layer 5	2	10		
layer 6	2	12		
layer 7	2	14		
layer 8	2	16		



distance from the center of gravity of strands to the bottom fiber of the beam = 7% of the beam depth  
strand eccentricity at midspan =  $(y_t - y_{bs})$

$y_{bs} =$	5.44 in
$e_c =$	31.16 in


### Prestress Losses

#### ELASTIC SHORTENING

assumed loss	=	6.00%
Force per strand at transfer		
layer 1	=	17.0 kips
layer 2	=	17.0 kips
layer 3	=	17.0 kips
layer 4	=	17.0 kips
layer 5	=	17.0 kips
layer 6	=	17.0 kips
layer 7	=	17.0 kips
layer 8	=	17.0 kips
layer 9	=	17.0 kips
layer 10	=	17.0 kips
layer 11	=	17.0 kips
layer 12	=	17.0 kips
layer 13	=	17.0 kips
layer 14	=	17.0 kips

		at midspan	at endspan
Total prestressing force at release	$P_i =$	1088.0 kips	1054.0 kips
Sum of concrete stresses at the center of gravity of prestressing tendons due to prestressing force at transfer and the self-weight of the member at sections of maximum moment	$f_{cgp} =$	2.412 ksi	2.307 ksi
Loss due to shortening		at midspan	at endspan
layer 1	$\Delta f_{pES} =$	13.9 ksi	13.3 ksi
layer 2	$\Delta f_{pES} =$	13.9 ksi	13.3 ksi
layer 3	$\Delta f_{pES} =$	13.9 ksi	13.3 ksi
layer 4	$\Delta f_{pES} =$	13.9 ksi	13.3 ksi
layer 5	$\Delta f_{pES} =$	13.9 ksi	13.3 ksi
layer 6	$\Delta f_{pES} =$	13.9 ksi	
layer 7	$\Delta f_{pES} =$	13.9 ksi	
layer 8	$\Delta f_{pES} =$	13.9 ksi	
layer 9	$\Delta f_{pES} =$	13.9 ksi	13.3 ksi
layer 10	$\Delta f_{pES} =$		13.3 ksi
layer 11	$\Delta f_{pES} =$		13.3 ksi
layer 12	$\Delta f_{pES} =$		13.3 ksi
layer 13	$\Delta f_{pES} =$		13.3 ksi
layer 14	$\Delta f_{pES} =$		13.3 ksi

#### SHRINKAGE

Shrinkage =  $(17 - 0.15 \times \text{Relative Humidity})$   $\Delta f_{pSR} =$  6.5 ksi  assume relative humidity = 70%

#### CREEP OF CONCRETE

Change of stresses at center of gravity of prestressing due to permanent loads except the loads acting at time of applying prestressing force, calculated at the same section as $f_{cgp}$	$\Delta f_{odp} =$	1.590 ksi	
loss due to creep	$\Delta f_{pCR} =$	at midspan 17.8 ksi	at endspan 16.5 ksi

**RELAXATION OF PRESTRESSING STRANDS**

loss due to relaxation after transfer		at midspan	at endspan
layer 1	$\Delta f_{PR2} =$	2.9 ksi	2.9 ksi
layer 2	$\Delta f_{PR2} =$	2.9 ksi	2.9 ksi
layer 3	$\Delta f_{PR2} =$	2.9 ksi	2.9 ksi
layer 4	$\Delta f_{PR2} =$	2.9 ksi	2.9 ksi
layer 5	$\Delta f_{PR2} =$	2.9 ksi	2.9 ksi
layer 6	$\Delta f_{PR2} =$	2.9 ksi	
layer 7	$\Delta f_{PR2} =$	2.9 ksi	
layer 8	$\Delta f_{PR2} =$	2.9 ksi	
layer 9	$\Delta f_{PR2} =$	2.9 ksi	2.9 ksi
layer 10	$\Delta f_{PR2} =$		2.9 ksi
layer 11	$\Delta f_{PR2} =$		2.9 ksi
layer 12	$\Delta f_{PR2} =$		2.9 ksi
layer 13	$\Delta f_{PR2} =$		2.9 ksi
layer 14	$\Delta f_{PR2} =$		2.9 ksi

**TOTAL LOSSES AT TRANSFER**

total loss  $\Delta f_{pES} = \Delta f_{pl}$

stress in tendons after transfer  $f_{pt} = f_{pr} - \Delta f_{pl}$

		at midspan	at endspan
layer 1	$f_{pt} =$	199.3 ksi	199.9 ksi
layer 2	$f_{pt} =$	199.3 ksi	199.9 ksi
layer 3	$f_{pt} =$	199.3 ksi	199.9 ksi
layer 4	$f_{pt} =$	199.3 ksi	199.9 ksi
layer 5	$f_{pt} =$	199.3 ksi	199.9 ksi
layer 6	$f_{pt} =$	199.3 ksi	
layer 7	$f_{pt} =$	199.3 ksi	
layer 8	$f_{pt} =$	199.3 ksi	
layer 9	$f_{pt} =$	199.3 ksi	199.9 ksi
layer 10	$f_{pt} =$		199.9 ksi
layer 11	$f_{pt} =$		199.9 ksi
layer 12	$f_{pt} =$		199.9 ksi
layer 13	$f_{pt} =$		199.9 ksi
layer 14	$f_{pt} =$		199.9 ksi

force per strand =  $f_{pt} \cdot \text{strand area}$

		at midspan	at endspan
layer 1	=	16.9 kips	17.0 kips
layer 2	=	16.9 kips	17.0 kips
layer 3	=	16.9 kips	17.0 kips
layer 4	=	16.9 kips	17.0 kips
layer 5	=	16.9 kips	17.0 kips
layer 6	=	16.9 kips	
layer 7	=	16.9 kips	
layer 8	=	16.9 kips	
layer 9	=	16.9 kips	17.0 kips
layer 10	=		17.0 kips
layer 11	=		17.0 kips
layer 12	=		17.0 kips
layer 13	=		17.0 kips
layer 14	=		17.0 kips
Total prestressing force after transfer	$P_i =$	1047.8 kips	1054.0 kips

Initial loss =  $(\Delta f_{pi}) / (f_{pi})$

		at midspan	at endspan
layer 1	% =	6.5%	6.2%
layer 2	% =	6.5%	6.2%
layer 3	% =	6.5%	6.2%
layer 4	% =	6.5%	6.2%
layer 5	% =	6.5%	6.2%
layer 6	% =	6.5%	
layer 7	% =	6.5%	
layer 8	% =	6.5%	
layer 9	% =	6.5%	6.2%
layer 10	% =		6.2%
layer 11	% =		6.2%
layer 12	% =		6.2%
layer 13	% =		6.2%
layer 14	% =		6.2%

OK  
OK  
OK  
OK  
OK  
OK  
OK  
OK  
OK  
OK  
OK  
OK  
OK  
OK  
OK



**TOTAL LOSSES AT SERVICE LOADS**

Total Losses		at midspan	at endspan
layer 1	$\Delta f_{pT} =$	41.1 ksi	40.5 ksi
layer 2	$\Delta f_{pT} =$	41.1 ksi	40.5 ksi
layer 3	$\Delta f_{pT} =$	41.1 ksi	40.5 ksi
layer 4	$\Delta f_{pT} =$	41.1 ksi	40.5 ksi
layer 5	$\Delta f_{pT} =$	41.1 ksi	40.5 ksi
layer 6	$\Delta f_{pT} =$	41.1 ksi	
layer 7	$\Delta f_{pT} =$	41.1 ksi	
layer 8	$\Delta f_{pT} =$	41.1 ksi	
layer 9	$\Delta f_{pT} =$	41.1 ksi	40.5 ksi
layer 10	$\Delta f_{pT} =$		40.5 ksi
layer 11	$\Delta f_{pT} =$		40.5 ksi
layer 12	$\Delta f_{pT} =$		40.5 ksi
layer 13	$\Delta f_{pT} =$		40.5 ksi
layer 14	$\Delta f_{pT} =$		40.5 ksi

Stress in tendon after all losses = $f_{pi} - \Delta f_{pi}$		at midspan	at endspan
layer 1	$f_{pe} =$	172.1 ksi	172.7 ksi
layer 2	$f_{pe} =$	172.1 ksi	172.7 ksi
layer 3	$f_{pe} =$	172.1 ksi	172.7 ksi
layer 4	$f_{pe} =$	172.1 ksi	172.7 ksi
layer 5	$f_{pe} =$	172.1 ksi	172.7 ksi
layer 6	$f_{pe} =$	172.1 ksi	
layer 7	$f_{pe} =$	172.1 ksi	
layer 8	$f_{pe} =$	172.1 ksi	
layer 9	$f_{pe} =$	172.1 ksi	172.7 ksi
layer 10	$f_{pe} =$		172.7 ksi
layer 11	$f_{pe} =$		172.7 ksi
layer 12	$f_{pe} =$		172.7 ksi
layer 13	$f_{pe} =$		172.7 ksi
layer 14	$f_{pe} =$		172.7 ksi

check prestressing stress limit at service limit state:  $f_{pe} \leq 0.8 \cdot f_{py}$

layer 1	=	205.4 ksi
layer 2	=	205.4 ksi
layer 3	=	205.4 ksi
layer 4	=	205.4 ksi
layer 5	=	205.4 ksi
layer 6	=	205.4 ksi
layer 7	=	205.4 ksi
layer 8	=	205.4 ksi
layer 9	=	205.4 ksi
layer 10	=	205.4 ksi
layer 11	=	205.4 ksi
layer 12	=	205.4 ksi
layer 13	=	205.4 ksi
layer 14	=	205.4 ksi

OK  
OK  
OK  
OK  
OK  
OK  
OK  
OK  
OK  
OK  
OK  
OK  
OK  
OK

force per strand =  $f_{pe} \cdot \text{strand area}$

		at midspan	at endspan
layer 1	=	14.6 kips	14.7 kips
layer 2	=	14.6 kips	14.7 kips
layer 3	=	14.6 kips	14.7 kips
layer 4	=	14.6 kips	14.7 kips
layer 5	=	14.6 kips	14.7 kips
layer 6	=	14.6 kips	
layer 7	=	14.6 kips	
layer 8	=	14.6 kips	
layer 9	=	14.6 kips	14.7 kips
layer 10	=		14.7 kips
layer 11	=		14.7 kips
layer 12	=		14.7 kips
layer 13	=		14.7 kips
layer 14	=		14.7 kips

		at midspan	at endspan
Total prestressing force after all losses	$P_{pe} =$	936.1 kips	939.4 kips
Final losses, % = $(\Delta f_{pT})/f_{pi}$			
layer 1	% =	19.3%	19.0%
layer 2	% =	19.3%	19.0%
layer 3	% =	19.3%	19.0%
layer 4	% =	19.3%	19.0%
layer 5	% =	19.3%	19.0%
layer 6	% =	19.3%	
layer 7	% =	19.3%	
layer 8	% =	19.3%	
layer 9	% =	19.3%	19.0%
layer 10	% =		19.0%
layer 11	% =		19.0%
layer 12	% =		19.0%
layer 13	% =		19.0%
layer 14	% =		19.0%
Average final losses, %	% =	19.3%	19.0%

### Stresses at Transfer

#### STRESS LIMITS FOR CONCRETE

Compression = $0.6f'_{ci}$	$f_{ci} =$	3.300 ksi
Tension		
without bonded reinforcement = $-0.0948\sqrt{f'_{ci}} \leq -0.2$	=	-0.200 ksi
with bonded auxiliary reinforcement = $-0.22\sqrt{f'_{ci}}$	=	-0.016 ksi

#### STRESSES AT TRANSFER LENGTH SECTION

Transfer Length = $60 \times (\text{strand diameter})$	=	1.9 ft	} Calcs for eccentricity (see 9.6.7.2)
Bending moment at transfer length	$M_g =$	87.7 ft-kips	
center of 12 strands to top fiber of beam at the end	=	7.00 in	
center of 12 strands to bottom fiber of beam at the harp point	=	11.00 in	
center of 12 strands and top fiber of beam at transfer length	=	9.84 in	
center of gravity of 32 strands and bottom fiber of beam	=	3.98 in	
center of gravity of all strands and the bottom fiber of beam at transfer length	=	15.24 in	
center of gravity of all strands and the bottom fiber of beam at the end	=	15.30 in	
Eccentricity of the strand group at transfer length:	$e_h =$	21.36 in	}
Eccentricity at end of beam:	$e =$	21.30 in	

$$f_t = \frac{P_i}{A} - \frac{P_i e}{S_t} + \frac{M_g}{S_t}$$

$$f_b = \frac{P_i}{A} + \frac{P_i e}{S_b} - \frac{M_g}{S_b}$$

		at midspan	at endspan	
Top stress at top fiber of beam	$f_t =$	-0.017 ksi	-0.017 ksi	OK
Bottom stress at bottom fiber of the beam	$f_b =$	2.906 ksi	2.906 ksi	OK

#### STRESSES AT HARP POINT

Bending moment due to beam weight at 0.3L	$M_g =$	1188.0 ft-kips		
Top stress at top fiber of beam	$f_t =$	0.173 ksi	0.169 ksi	OK
Bottom stress at bottom fiber of the beam	$f_b =$	2.736 ksi	2.621 ksi	OK

#### STRESSES AT MIDSPAN

Bending moment due to beam weight at 0.5L	$M_g =$	1414.3 ft-kips		
Top stress at top fiber of beam	$f_t =$	0.320 ksi	0.345 ksi	OK
Bottom stress at bottom fiber of the beam	$f_b =$	2.554 ksi	2.438 ksi	OK

#### HOLD-DOWN FORCES

assume stress in strand before losses =  $0.8f_u$

layer 1	=	227.4 ksi
layer 2	=	227.4 ksi
layer 3	=	227.4 ksi
layer 4	=	227.4 ksi
layer 5	=	227.4 ksi
layer 6	=	227.4 ksi
layer 7	=	227.4 ksi
layer 8	=	227.4 ksi
layer 9	=	227.4 ksi
layer 10	=	227.4 ksi
layer 11	=	227.4 ksi
layer 12	=	227.4 ksi
layer 13	=	227.4 ksi
layer 14	=	227.4 ksi

prestress force per strand before any losses:

layer 1	=	19.3 kips
layer 2	=	19.3 kips
layer 3	=	19.3 kips
layer 4	=	19.3 kips
layer 5	=	19.3 kips
layer 6	=	19.3 kips
layer 7	=	19.3 kips
layer 8	=	19.3 kips
layer 9	=	19.3 kips
layer 10	=	19.3 kips
layer 11	=	19.3 kips
layer 12	=	19.3 kips
layer 13	=	19.3 kips
layer 14	=	19.3 kips
Harp Angle	$\psi$ =	7.2 °

Hold-down force/strand

layer 1	=	2.5 kips/strand
layer 2	=	2.5 kips/strand
layer 3	=	2.5 kips/strand
layer 4	=	2.5 kips/strand
layer 5	=	2.5 kips/strand
layer 6	=	2.5 kips/strand
layer 7	=	2.5 kips/strand
layer 8	=	2.5 kips/strand
layer 9	=	2.5 kips/strand
layer 10	=	2.5 kips/strand
layer 11	=	2.5 kips/strand
layer 12	=	2.5 kips/strand
layer 13	=	2.5 kips/strand
layer 14	=	2.5 kips/strand
Total hold-down force	=	30.45 kips

### Stresses at Service Loads

#### STRESS LIMITS FOR CONCRETE

Compression:

Due to permanent loads for load combination Service I

for the precast beam	=	3.150 ksi
for deck	=	1.463 ksi

Due to permanent and transient loads for load combination Service I

for the precast beam	=	4.200 ksi
for deck	=	1.950 ksi

Tension:

Load Combination Service III

for the precast beam	=	-0.016 ksi
----------------------	---	------------

#### STRESSES AT MIDSPAN

Compression stresses at top fiber of beam	at midspan	at endspan		
$f_1 = \frac{P_{pe}}{A} - \frac{P_{pe}e}{S_1} + \frac{(M_w + M_d)}{S_t} + \frac{(M_w + M_b)}{S_{tg}}$	$f_{1g} =$	2.111 ksi	2.109 ksi	OK
Due to permanent loads				
$f_{1g} = \frac{P_M}{A} - \frac{P_{pe}e}{S_1} + \frac{(M_w + M_d)}{S_t} + \frac{(M_w - M_b)}{S_{tg}} + \frac{(M_{DL})}{S_{tg}}$	$f_{1g} =$	2.585 ksi	2.582 ksi	OK
Due to permanent loads and transient loads				
<b>Compression stresses at top fiber of deck</b>	<b>at midspan</b>	<b>at endspan</b>		
$f_{1g} = \frac{(M_w + M_b)}{S_{tc}}$	$f_{1g} =$	0.044 ksi	0.044 ksi	OK
Due to permanent loads				
$f_{1g} = \frac{(M_w + M_b + M_{DL})}{S_{tc}}$	$f_{1g} =$	0.502 ksi	0.502 ksi	OK
Due to permanent loads and transient loads				
<b>Tension stresses at top fiber of deck</b>	<b>at midspan</b>	<b>at endspan</b>		
$f_{1g} = \frac{P_{pe}}{A} + \frac{P_{pe}e}{S_b} - \frac{(M_w + M_d)}{S_b} - \frac{(M_w + M_b + 0.8 * M_{DL})}{S_{tr}}$	$f_{1g} =$	-0.835 ksi	-0.824 ksi	OK
Load Combination Service III				

**Strength Limit State**

POSITIVE MOMENT SECTION		
$M_u = 1.25DC+1.5DW+1.75(LL+IM)$	$M_u =$	8381.5 ft-kips
effective length factor for compression members		
layer 1	k =	0.27
layer 2	k =	0.27
layer 3	k =	0.27
layer 4	k =	0.27
layer 5	k =	0.27
layer 6	k =	0.27
layer 7	k =	0.27
layer 8	k =	0.27
layer 9	k =	0.27
layer 10	k =	0.27
layer 11	k =	0.27
layer 12	k =	0.27
layer 13	k =	0.27
layer 14	k =	0.27
	c =	5.6 ft-kips

average stress in prestressing steel

layer 1	$f_{ps} =$	278.3 ksi
layer 2	$f_{ps} =$	278.3 ksi
layer 3	$f_{ps} =$	278.3 ksi
layer 4	$f_{ps} =$	278.3 ksi
layer 5	$f_{ps} =$	278.3 ksi
layer 6	$f_{ps} =$	278.3 ksi
layer 7	$f_{ps} =$	278.3 ksi
layer 8	$f_{ps} =$	278.3 ksi
layer 9	$f_{ps} =$	278.3 ksi
layer 10	$f_{ps} =$	278.3 ksi
layer 11	$f_{ps} =$	278.3 ksi
layer 12	$f_{ps} =$	278.3 ksi
layer 13	$f_{ps} =$	278.3 ksi
layer 14	$f_{ps} =$	278.3 ksi

nominal flexure resistance

	a =	4.80 in	
$M_r = \Phi M_n, \Phi = 1.00$	$\Phi M_n =$	9105.1 ft-kips	OK
M=DC+W+LL+IM	M =	5833.6 ft-kips	OK
NEGATIVE MOMENT SECTION			
$M_u = 1.25DC+1.5DW+1.75(LL+IM)$	$M_u =$	-4837.2 ft-kips	
	a =	5.43 in	
	$\Phi M_n =$	4468.5 ft-kips	NOT OK
M=DC+W+LL+IM	M =	-2869.7 ft-kips	OK

## Shear Design

CRITICAL SECTION AT 0.59		
$V_u = 1.25DC + 1.5DW + 1.75(LL + IM)$	$V_u =$	405.0 kips
$M_u = 1.25DC + 1.5DW + 1.75(LL + IM)$	$M_u =$	-2684.4 ft-kips
or		
$V_u = 1.25DC + 1.5DW + 1.75(LL + IM)$	$V_u =$	364.8 kips
$M_u = 1.25DC + 1.5DW + 1.75(LL + IM)$	$M_u =$	-2877.0 ft-kips
max shear	$V_u =$	405.0 kips
max moment	$M_u =$	2877.0 ft-kips
Shear depth	$d_v =$	73.19 in
Applied factored normal force at the section	$N_u =$	0
Angle of diagonal compressive stresses	$\theta =$	36.00 °

### STRAIN IN FLEXURAL TENSION REINFORCEMENT

$$\epsilon_s = \frac{\frac{M_u}{d_v} + 0.5N_u \cot \theta + A_{ps} f_{ps}}{E_s A_s + E_p A_{ps}} \leq 0.002$$

	at midspan	at endspan
resultant compressive stress at centroid	$f_{pc} =$ 0.938 ksi	0.940 ksi

effective stress in prestressing strand after all losses

	at midspan	at endspan
layer 1	$f_{po} =$ 176.9 ksi	177.5 ksi
layer 2	$f_{po} =$ 176.9 ksi	177.5 ksi
layer 3	$f_{po} =$ 176.9 ksi	177.5 ksi
layer 4	$f_{po} =$ 176.9 ksi	177.5 ksi
layer 5	$f_{po} =$ 176.9 ksi	
layer 6	$f_{po} =$ 176.9 ksi	
layer 7	$f_{po} =$ 176.9 ksi	
layer 8	$f_{po} =$ 176.9 ksi	
layer 9	$f_{po} =$	177.5 ksi
layer 10	$f_{po} =$	177.5 ksi
layer 11	$f_{po} =$	177.5 ksi
layer 12	$f_{po} =$	177.5 ksi
layer 13	$f_{po} =$	177.5 ksi
layer 14	$f_{po} =$	177.5 ksi

strain in flexural tension

	at midspan	at endspan
layer 1	$\epsilon_x =$ 0.002000	0.002000
layer 2	$\epsilon_x =$ 0.002000	0.002000
layer 3	$\epsilon_x =$ 0.002000	0.002000
layer 4	$\epsilon_x =$ 0.002000	0.002000
layer 5	$\epsilon_x =$ 0.002000	
layer 6	$\epsilon_x =$ 0.002000	
layer 7	$\epsilon_x =$ 0.002000	
layer 8	$\epsilon_x =$ 0.002000	
layer 9	$\epsilon_x =$	0.002000
layer 10	$\epsilon_x =$	0.002000
layer 11	$\epsilon_x =$	0.002000
layer 12	$\epsilon_x =$	0.002000
layer 13	$\epsilon_x =$	0.002000
layer 14	$\epsilon_x =$	0.002000

## Deflection and Camber

	at midspan	at endspan
Deflection due to Prestressing Force at Transfer	$\Delta_p =$ 3.27 in	3.29 in
Deflection due to Beam Self-Weight at Transfer	$\Delta_g =$ -1.49 in	
Deflection due to Beam Self-Weight at Erection	$\Delta_g =$ -1.44 in	
Deflection due to Haunch and Deck	$\Delta_g =$ -1.95 in	

Deflection due to total self weight	$\Delta_{sw} =$ -0.11 in
-------------------------------------	--------------------------

Total Deflection at transfer	$\Delta =$ 1.79 in	1.81 in
Total Deflection at erection	$\Delta =$ 3.24 in	3.27 in

Live load deflection limit = span/800	$=$ 1.80 in
Deflection due to live load and impact	$\Delta_L =$ -0.87 in

OK

Deflection due to fire truck	$\Delta_L =$ -0.7830 in
Total Deflection after fire with fire truck	$\Delta =$ 2.3818 in

OK

**Location: Fire at Critical Negative Moment Sections**  
**Beam Design: 3/8" Strand**  
**Fire Exposure Status: 3 Hour**

(PCI Bridge Design Manual Section 9.6)

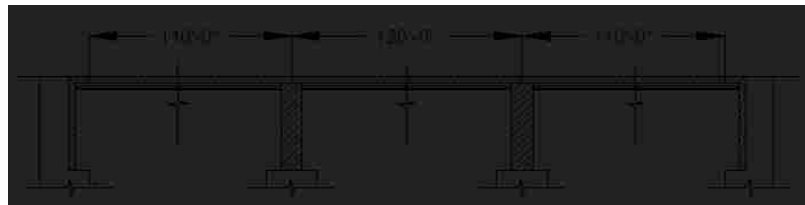


**Material Properties**

CAST-IN-PLACE SLAB		
Actual Thickness	$t_{as} =$	8.0 in
Wearing Surface	$=$	0.5 in
Structural thickness = Actual - Wearing Surface	$t_s =$	7.5 in
Compressive Strength	$f'_c =$	3.02 ksi
Unit Weight	$w_c =$	150.0 pcf
Stress factor of compression block	$\beta_1 =$	0.85

BEAMS: AASHTO-PCI, BT-72 BULB-TEE		
Strength at release	$f'_{ci} =$	5.5 ksi
Strength at 28 days	$f'_c =$	7 ksi
Unit Weight	$w_c =$	150.0 pcf
Overall Beam Length:		
@ end spans	$L =$	110 ft
@ center span	$L =$	119 ft
Design Spans:		
Non-composite beam @ end spans	$L =$	109 ft
Non-composite beam @ center span	$L =$	118 ft
Composite beam @ end spans	$L =$	110 ft
Composite beam @ center span	$L =$	120 ft
Beam Spacing	$S =$	12 ft



**PRESTRESSING STRANDS**

Diameter of single strand	d =	0.4 in
Area of single strand	A =	0.085 in <sup>2</sup>

Temperature of Layer

layer 1 (bottom)	T =	68.00 °F
layer 2	T =	68.00 °F
layer 3	T =	68.00 °F
layer 4	T =	68.00 °F
layer 5	T =	68.00 °F
layer 6	T =	68.00 °F
layer 7	T =	68.00 °F
layer 8	T =	68.00 °F
layer 9	T =	68.00 °F
layer 10	T =	68.00 °F
layer 11	T =	68.00 °F
layer 12	T =	68.00 °F
layer 13	T =	68.00 °F
layer 14	T =	68.00 °F

Ultimate Strength

initial = 284 ksi

layer 1 (bottom)	f <sub>pu</sub> =	284 ksi
layer 2	f <sub>pu</sub> =	284 ksi
layer 3	f <sub>pu</sub> =	284 ksi
layer 4	f <sub>pu</sub> =	284 ksi
layer 5	f <sub>pu</sub> =	284 ksi
layer 6	f <sub>pu</sub> =	284 ksi
layer 7	f <sub>pu</sub> =	284 ksi
layer 8	f <sub>pu</sub> =	284 ksi
layer 9	f <sub>pu</sub> =	284 ksi
layer 10	f <sub>pu</sub> =	284 ksi
layer 11	f <sub>pu</sub> =	284 ksi
layer 12	f <sub>pu</sub> =	284 ksi
layer 13	f <sub>pu</sub> =	284 ksi
layer 14	f <sub>pu</sub> =	284 ksi

Yield Strength

initial = 257 ksi

layer 1 (bottom)	f <sub>py</sub> =	257 ksi
layer 2	f <sub>py</sub> =	257 ksi
layer 3	f <sub>py</sub> =	257 ksi
layer 4	f <sub>py</sub> =	257 ksi
layer 5	f <sub>py</sub> =	257 ksi
layer 6	f <sub>py</sub> =	257 ksi
layer 7	f <sub>py</sub> =	257 ksi
layer 8	f <sub>py</sub> =	257 ksi
layer 9	f <sub>py</sub> =	257 ksi
layer 10	f <sub>py</sub> =	257 ksi
layer 11	f <sub>py</sub> =	257 ksi
layer 12	f <sub>py</sub> =	257 ksi
layer 13	f <sub>py</sub> =	257 ksi
layer 14	f <sub>py</sub> =	257 ksi

**Stress Limits:**

before transfer  $\leq 0.75f_{pu}$  (initial = 213.2)

layer 1 (bottom)	f <sub>di</sub> =	213.2 ksi
layer 2	f <sub>di</sub> =	213.2 ksi
layer 3	f <sub>di</sub> =	213.2 ksi
layer 4	f <sub>di</sub> =	213.2 ksi
layer 5	f <sub>di</sub> =	213.2 ksi
layer 6	f <sub>di</sub> =	213.2 ksi
layer 7	f <sub>di</sub> =	213.2 ksi
layer 8	f <sub>di</sub> =	213.2 ksi
layer 9	f <sub>di</sub> =	213.2 ksi
layer 10	f <sub>di</sub> =	213.2 ksi
layer 11	f <sub>di</sub> =	213.2 ksi
layer 12	f <sub>di</sub> =	213.2 ksi
layer 13	f <sub>di</sub> =	213.2 ksi
layer 14	f <sub>di</sub> =	213.2 ksi

at service limit state (after all losses)  $\leq 0.80f_{py}$  (initial = 205.4)

layer 1 (bottom)	$f_{pe} =$	205.4 ksi
layer 2	$f_{pe} =$	205.4 ksi
layer 3	$f_{pe} =$	205.4 ksi
layer 4	$f_{pe} =$	205.4 ksi
layer 5	$f_{pe} =$	205.4 ksi
layer 6	$f_{pe} =$	205.4 ksi
layer 7	$f_{pe} =$	205.4 ksi
layer 8	$f_{pe} =$	205.4 ksi
layer 9	$f_{pe} =$	205.4 ksi
layer 10	$f_{pe} =$	205.4 ksi
layer 11	$f_{pe} =$	205.4 ksi
layer 12	$f_{pe} =$	205.4 ksi
layer 13	$f_{pe} =$	205.4 ksi
layer 14	$f_{pe} =$	205.4 ksi

Modulus of Elasticity

initial = 25898 ksi

layer 1 (bottom)	$E =$	25898.0 ksi
layer 2	$E =$	25898.0 ksi
layer 3	$E =$	25898.0 ksi
layer 4	$E =$	25898.0 ksi
layer 5	$E =$	25898.0 ksi
layer 6	$E =$	25898.0 ksi
layer 7	$E =$	25898.0 ksi
layer 8	$E =$	25898.0 ksi
layer 9	$E =$	25898.0 ksi
layer 10	$E =$	25898.0 ksi
layer 11	$E =$	25898.0 ksi
layer 12	$E =$	25898.0 ksi
layer 13	$E =$	25898.0 ksi
layer 14	$E =$	25898.0 ksi

#### MILD STEEL REINFORCING BARS

Yield Strength

Layer 1 (Bottom)	$f_y =$	60.0 ksi	68.00 °F
Layer 2 (Top)	$f_y =$	48.0 ksi	1300.00 °F

Modulus of Elasticity

Layer 1 (Bottom)	$E =$	29000.0 ksi
Layer 2 (Top)	$E =$	29000.0 ksi

Layer 1 (Bottom)

Area of steel at midspan (effective flange)	$A_{sm} =$	2.79 in <sup>2</sup>
Area of steel at endspan (effective flange)	$A_{se} =$	2.48 in <sup>2</sup>
Area of temperature and shrinkage steel (12" width)	$A_s =$	0.31 in <sup>2</sup>

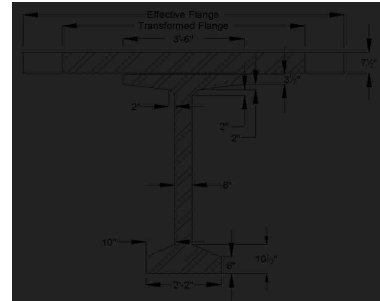
Layer 2 (Top)

Area of steel at midspan (effective flange)	$A_{sm} =$	12.6 in <sup>2</sup>
Area of steel at endspan (effective flange)	$A_{se} =$	12.4 in <sup>2</sup>
Area of temperature and shrinkage steel (12" width)	$A_s =$	0.2 in <sup>2</sup>

#### Cross-sectional Properties

##### NON-COMPOSITE BEAM

Area of cross-section of beam	$A =$	767.0 in <sup>2</sup>
Overall depth of beam	$H =$	72.0 in
Moment of Inertia	$I =$	539,947 in <sup>4</sup>
Distance from centroid to extreme bottom fiber	$y_b =$	36.6 in
Distance from centroid to extreme top fiber	$y_t =$	35.4 in
Section modulus for the extreme bottom fiber	$S_b =$	14915.0 in <sup>3</sup>
Section modulus for the extreme top fiber	$S_t =$	15421.0 in <sup>3</sup>
Weight	$W_t =$	799.0 plf
Modulus of Elasticity = $33000 \cdot (W_c^{1.5}) \cdot (\sqrt{f'_c})$		
cast-in-place concrete deck	$E_{cs} =$	3332 ksi
precast beam at release	$E_{ci} =$	4496 ksi
precast beam at service loads	$E_c =$	5072 ksi





### COMPOSITE BEAM AT MIDSPAN

Effective Flange Width	$b_f =$	111.0 in	*min of three criteria
Modular Ratio = $E_{cs}/E_c$	$n =$	0.6568	
Transformed flange width	$=$	72.9 in	
Transformed flange area	$=$	546.8 in <sup>2</sup>	
Transformed haunch width	$=$	27.6 in	
Transformed haunch area	$=$	13.8 in <sup>2</sup>	
Deck-distance to top fiber	$y_t =$	5.62 in	

	Transformed Area	$y_b$	$Ay_b$	$A(y_{bc}-y_b)^2$	I	$I + A(y_{bc}-y_b)^2$
Beam	767.0 in <sup>2</sup>	36.60 in	28,072.2 in <sup>3</sup>	194,666 in <sup>4</sup>	539,947 in <sup>4</sup>	734,613 in <sup>4</sup>
Haunch	13.8 in <sup>2</sup>	72.25 in	996.6 in <sup>3</sup>	5,363 in <sup>4</sup>	0.29 in <sup>4</sup>	5,364 in <sup>4</sup>
Deck	546.8 in <sup>2</sup>	74.38 in	40,671.9 in <sup>3</sup>	261,033 in <sup>4</sup>	873 in <sup>4</sup>	261,905 in <sup>4</sup>
Total	1327.6 in <sup>2</sup>		69,740.7 in <sup>3</sup>			1,001,882 in <sup>4</sup>

Total area of Composite Section	$A_c =$	1328 in <sup>2</sup>
Overall Depth of the Composite Section	$h_c =$	80 in
Moment of Inertia	$I_c =$	1,001,882 in <sup>4</sup>
Distance from centroid to extreme <u>bottom</u> fiber of beam	$y_{bc} =$	52.53 in
Distance from centroid to extreme <u>top</u> fiber of beam	$y_{tg} =$	19.47 in
Distance from centroid to extreme <u>top</u> fiber of slab	$y_{tc} =$	27.47 in
Section modulus for the extreme <u>bottom</u> fiber of beam	$S_{bc} =$	19,072.2 in <sup>3</sup>
Section modulus for the extreme <u>top</u> fiber of beam	$S_{tg} =$	51,460.9 in <sup>3</sup>
Section modulus for the extreme <u>top</u> fiber slab	$S_{tc} =$	55,529.3 in <sup>3</sup>

### COMPOSITE BEAM AT ENDSPAN

Effective Flange Width	$b_f =$	106.6 in	*min of three criteria
Modular Ratio = $E_{cs}/E_c$	$n =$	0.6568	
Transformed flange width	$=$	70.0 in	
Transformed flange area	$=$	525.1 in <sup>2</sup>	
Transformed haunch width	$=$	27.6 in	
Transformed haunch area	$=$	13.8 in <sup>2</sup>	
Deck-distance to top fiber	$y_{td} =$	5.62 in	

	Transformed Area	$y_t$	$Ay_t$	$A(y_{tc}-y_t)^2$	I	$I + A(y_{tc}-y_t)^2$
Beam	767.0 in <sup>2</sup>	36.60 in	28,072.2 in <sup>3</sup>	256,088 in <sup>4</sup>	539,947 in <sup>4</sup>	796,035 in <sup>4</sup>
Haunch	13.8 in <sup>2</sup>	72.25 in	996.6 in <sup>3</sup>	4,605 in <sup>4</sup>	0.29 in <sup>4</sup>	4,606 in <sup>4</sup>
Deck	525.1 in <sup>2</sup>	78.12 in	41,023.7 in <sup>3</sup>	175,334 in <sup>4</sup>	840 in <sup>4</sup>	176,174 in <sup>4</sup>
Total	1305.9 in <sup>2</sup>		70,092.5 in <sup>3</sup>			976,814 in <sup>4</sup>

Total area of Composite Section	$A_c =$	1306 in <sup>2</sup>
Overall Depth of the Composite Section	$h_c =$	80 in
Moment of Inertia	$I_c =$	976,814 in <sup>4</sup>
Distance from centroid to extreme <u>bottom</u> fiber of beam	$y_{bc} =$	53.67 in
Distance from centroid to extreme <u>top</u> fiber of beam	$y_{tg} =$	18.33 in
Distance from centroid to extreme <u>top</u> fiber of slab	$y_{tc} =$	26.33 in
Section modulus for the extreme <u>bottom</u> fiber of beam	$S_{bc} =$	18,199.6 in <sup>3</sup>
Section modulus for the extreme <u>top</u> fiber of beam	$S_{tg} =$	53,297.6 in <sup>3</sup>
Section modulus for the extreme <u>top</u> fiber slab	$S_{tc} =$	37,102.4 in <sup>3</sup>

### Shear Forces and Bending Moments

#### DEAD LOADS

Beam self-weight	$W_{beam} =$	0.799 k/f
8 in. deck weight	$W_{deck} =$	1.200 k/f
1/2 in. haunch weight	$W_{haunch} =$	0.022 k/f

#### LRFD Specifications: Art. 4.6.2.2.1

Width of Deck Constant		OK
Number of beams is not less than four $N_b =$	4	OK
Roadway part of the overhang, $d_s \leq 3.0$ ft, $d_s =$	1.5	OK
Curvature in plans is less than 4° =	0	OK
Cross-section of the bridge is consistent with one of the cross sections given by LRFD specs		OK

Barrier and wearing surface loads are equally distributed among the 4 beams

Barrier Wt	$W_t =$	0.150 k/f
Dead load of future wearing surface	$DW =$	0.263 k/f

LIVE LOADS		
Fire truck live load front load (Point A)	$P_{live} =$	48.0 kips
Fire truck live load back load (Point B)	$P_{live} =$	22.0 kips
distance between two loads		19.2 ft
distance from nearest edge to point A	$x_a =$	59.0 ft
distance from nearest edge to point B	$x_b =$	39.8 ft
LRFD Specifications: Art. 4.6.2.2.1		
Width of Deck Constant		OK
Number of beams is not less than four $N_b =$	4	OK
Beams are parallel and approximately of the same stiffness		OK
Roadway part of the overhang, $d_s \leq 3.0$ ft, $d_e =$	1.5	OK
Curvature in plans is less than $4^\circ =$	0	OK

Barrier and wearing surface loads are equally distributed among the 4 beams

Bridge Type-- "k" (LRFD Table 4.6.2.2.1-1)		
Number of design lanes = $w/12$	=	3 lanes

#### Distribution Factor for Bending Moment:

Beams spacing	$S =$	12.0 ft
Depth of concrete slab	$t_s =$	7.5 in
Beam Span	$L =$	120.0 ft
Number of Beams	$N_b =$	4
Modular ratio between beam & deck materials	$n =$	1.5225
Longitudinal stiffness parameter	$K_g =$	2,657,855.22 in <sup>4</sup>

at center span:		
$DFM = 0.75 \left[ \left( \frac{S}{3.5} \right)^{0.1} + \left( \frac{S}{L} \right)^{0.2} + \left( \frac{K_g}{12 * L * t_s^3} \right)^{0.1} \right]$		
DFM =		0.916 lanes/beam

0.905 Controls

one design lane loaded:		
$DFM = 0.75 + \left( \frac{S}{4} \right)^{0.4} + \left( \frac{S}{L} \right)^{0.3} + \left( \frac{K_g}{2 * L * t_s^3} \right)^{0.1}$		
DFM =		0.621 lanes/beam

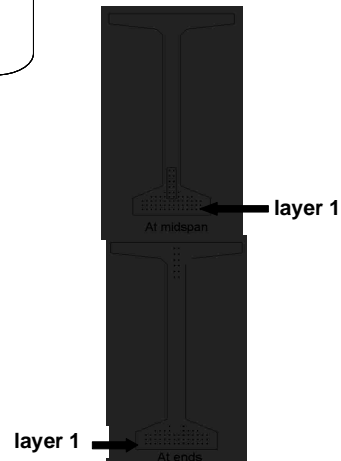
#### Distribution Factor for Shear Force

both end spans and center span:		
$DFV = 0.2 + \left( \frac{S}{12} \right) + \left( \frac{S}{35} \right)^2$		
DFV =		1.082 lanes/beam

1.082 Controls

one design lane loaded:		
$DFV = 0.36 + \left( \frac{S}{25} \right)$		
DFV =		0.840 lanes/beam

from bottom	At Midspan		At Ends	
	No. of	Distance from Bottom	No. of	Distance from Bottom
layer 1	14	2	14	2
layer 2	14	3.5	14	3.5
layer 3	14	5	14	5
layer 4	10	6.5	8	6.5
layer 5	4	8	2	8
layer 6	2	10	-	-
layer 7	2	12	-	-
layer 8	2	14	-	-
layer 9	2	16	2	60
layer 10	-	-	2	62
layer 11	-	-	2	64
layer 12	-	-	2	66
layer 13	-	-	2	68
layer 14	-	-	2	70
	64		64	
<b>Harped Strand Group (included in above totals)</b>				
layer 3	2	6		
layer 4	2	8		
layer 5	2	10		
layer 6	2	12		
layer 7	2	14		
layer 8	2	16		



distance from the center of gravity of strands to the bottom fiber of the beam = 7% of the beam depth  
strand eccentricity at midspan =  $(y_c - y_{bs})$

$y_{bs} =$	5.44 in
$e_c =$	31.16 in

### Prestress Losses

#### ELASTIC SHORTENING

assumed loss	=	6.00%
Force per strand at transfer		
layer 1	=	17.0 kips
layer 2	=	17.0 kips
layer 3	=	17.0 kips
layer 4	=	17.0 kips
layer 5	=	17.0 kips
layer 6	=	17.0 kips
layer 7	=	17.0 kips
layer 8	=	17.0 kips
layer 9	=	17.0 kips
layer 10	=	17.0 kips
layer 11	=	17.0 kips
layer 12	=	17.0 kips
layer 13	=	17.0 kips
layer 14	=	17.0 kips

Total prestressing force at release	$P_i =$	at midspan 1088.0 kips	at endspan 1054.0 kips
	$f_{cgp} =$	2.412 ksi	2.307 ksi
Sum of concrete stresses at the center of gravity of prestressing tendons due to prestressing force at transfer and the self-weight of the member at sections of maximum moment			
Loss due to shortening		at midspan	at endspan
	layer 1	$\Delta f_{pES} =$ 13.9 ksi	13.3 ksi
layer 2	$\Delta f_{pES} =$ 13.9 ksi	13.3 ksi	
layer 3	$\Delta f_{pES} =$ 13.9 ksi	13.3 ksi	
layer 4	$\Delta f_{pES} =$ 13.9 ksi	13.3 ksi	
layer 5	$\Delta f_{pES} =$ 13.9 ksi	13.3 ksi	
layer 6	$\Delta f_{pES} =$ 13.9 ksi		
layer 7	$\Delta f_{pES} =$ 13.9 ksi		
layer 8	$\Delta f_{pES} =$ 13.9 ksi		
layer 9	$\Delta f_{pES} =$ 13.9 ksi		13.3 ksi
layer 10	$\Delta f_{pES} =$		13.3 ksi
layer 11	$\Delta f_{pES} =$		13.3 ksi
layer 12	$\Delta f_{pES} =$		13.3 ksi
layer 13	$\Delta f_{pES} =$		13.3 ksi
layer 14	$\Delta f_{pES} =$		13.3 ksi

#### SHRINKAGE

Shrinkage =  $(17 - 0.15 \times \text{Relative Humidity})$   $\Delta f_{pSR} =$  6.5 ksi ← assume relative humidity = 70%

#### CREEP OF CONCRETE

Change of stresses at center of gravity of prestressing due to permanent loads except the loads acting at time of applying prestressing force, calculated at the same section as $f_{cgp}$	$\Delta f_{cgp} =$	1.592 ksi	
	loss due to creep	$\Delta f_{PCR} =$	at midspan 17.8 ksi

**RELAXATION OF PRESTRESSING STRANDS**

loss due to relaxation after transfer		at midspan	at endspan
layer 1	$\Delta f_{PR2} =$	2.9 ksi	2.9 ksi
layer 2	$\Delta f_{PR2} =$	2.9 ksi	2.9 ksi
layer 3	$\Delta f_{PR2} =$	2.9 ksi	2.9 ksi
layer 4	$\Delta f_{PR2} =$	2.9 ksi	2.9 ksi
layer 5	$\Delta f_{PR2} =$	2.9 ksi	2.9 ksi
layer 6	$\Delta f_{PR2} =$	2.9 ksi	
layer 7	$\Delta f_{PR2} =$	2.9 ksi	
layer 8	$\Delta f_{PR2} =$	2.9 ksi	
layer 9	$\Delta f_{PR2} =$	2.9 ksi	2.9 ksi
layer 10	$\Delta f_{PR2} =$		2.9 ksi
layer 11	$\Delta f_{PR2} =$		2.9 ksi
layer 12	$\Delta f_{PR2} =$		2.9 ksi
layer 13	$\Delta f_{PR2} =$		2.9 ksi
layer 14	$\Delta f_{PR2} =$		2.9 ksi

**TOTAL LOSSES AT TRANSFER**

total loss  $\Delta f_{pES} = \Delta f_{pl}$

stress in tendons after transfer  $f_{pt} = f_{pr} - \Delta f_{pl}$

		at midspan	at endspan
layer 1	$f_{pt} =$	199.3 ksi	199.9 ksi
layer 2	$f_{pt} =$	199.3 ksi	199.9 ksi
layer 3	$f_{pt} =$	199.3 ksi	199.9 ksi
layer 4	$f_{pt} =$	199.3 ksi	199.9 ksi
layer 5	$f_{pt} =$	199.3 ksi	199.9 ksi
layer 6	$f_{pt} =$	199.3 ksi	
layer 7	$f_{pt} =$	199.3 ksi	
layer 8	$f_{pt} =$	199.3 ksi	
layer 9	$f_{pt} =$	199.3 ksi	199.9 ksi
layer 10	$f_{pt} =$		199.9 ksi
layer 11	$f_{pt} =$		199.9 ksi
layer 12	$f_{pt} =$		199.9 ksi
layer 13	$f_{pt} =$		199.9 ksi
layer 14	$f_{pt} =$		199.9 ksi

force per strand =  $f_{pt} \cdot \text{strand area}$

		at midspan	at endspan
layer 1	=	16.9 kips	17.0 kips
layer 2	=	16.9 kips	17.0 kips
layer 3	=	16.9 kips	17.0 kips
layer 4	=	16.9 kips	17.0 kips
layer 5	=	16.9 kips	17.0 kips
layer 6	=	16.9 kips	
layer 7	=	16.9 kips	
layer 8	=	16.9 kips	
layer 9	=	16.9 kips	17.0 kips
layer 10	=		17.0 kips
layer 11	=		17.0 kips
layer 12	=		17.0 kips
layer 13	=		17.0 kips
layer 14	=		17.0 kips

Total prestressing force after transfer

Initial loss =  $(\Delta f_{pl}) / (f_{pr})$

		at midspan	at endspan
layer 1	% =	6.5%	6.2%
layer 2	% =	6.5%	6.2%
layer 3	% =	6.5%	6.2%
layer 4	% =	6.5%	6.2%
layer 5	% =	6.5%	6.2%
layer 6	% =	6.5%	
layer 7	% =	6.5%	
layer 8	% =	6.5%	
layer 9	% =	6.5%	6.2%
layer 10	% =		6.2%
layer 11	% =		6.2%
layer 12	% =		6.2%
layer 13	% =		6.2%
layer 14	% =		6.2%

OK  
OK  
OK  
OK  
OK  
OK  
OK  
OK  
OK  
OK  
OK  
OK  
OK  
OK

**TOTAL LOSSES AT SERVICE LOADS**

Total Losses		at midspan	at endspan
layer 1	$\Delta f_{pT} =$	41.1 ksi	40.5 ksi
layer 2	$\Delta f_{pT} =$	41.1 ksi	40.5 ksi
layer 3	$\Delta f_{pT} =$	41.1 ksi	40.5 ksi
layer 4	$\Delta f_{pT} =$	41.1 ksi	40.5 ksi
layer 5	$\Delta f_{pT} =$	41.1 ksi	40.5 ksi
layer 6	$\Delta f_{pT} =$	41.1 ksi	
layer 7	$\Delta f_{pT} =$	41.1 ksi	
layer 8	$\Delta f_{pT} =$	41.1 ksi	
layer 9	$\Delta f_{pT} =$	41.1 ksi	40.5 ksi
layer 10	$\Delta f_{pT} =$		40.5 ksi
layer 11	$\Delta f_{pT} =$		40.5 ksi
layer 12	$\Delta f_{pT} =$		40.5 ksi
layer 13	$\Delta f_{pT} =$		40.5 ksi
layer 14	$\Delta f_{pT} =$		40.5 ksi

Stress in tendon after all losses = $f_{pi} - \Delta f_{pi}$		at midspan	at endspan
layer 1	$f_{pe} =$	172.1 ksi	172.7 ksi
layer 2	$f_{pe} =$	172.1 ksi	172.7 ksi
layer 3	$f_{pe} =$	172.1 ksi	172.7 ksi
layer 4	$f_{pe} =$	172.1 ksi	172.7 ksi
layer 5	$f_{pe} =$	172.1 ksi	172.7 ksi
layer 6	$f_{pe} =$	172.1 ksi	
layer 7	$f_{pe} =$	172.1 ksi	
layer 8	$f_{pe} =$	172.1 ksi	
layer 9	$f_{pe} =$	172.1 ksi	172.7 ksi
layer 10	$f_{pe} =$		172.7 ksi
layer 11	$f_{pe} =$		172.7 ksi
layer 12	$f_{pe} =$		172.7 ksi
layer 13	$f_{pe} =$		172.7 ksi
layer 14	$f_{pe} =$		172.7 ksi

check prestressing stress limit at service limit state:  $f_{pe} \leq 0.8 \cdot f_{py}$

layer 1	=	205.4 ksi
layer 2	=	205.4 ksi
layer 3	=	205.4 ksi
layer 4	=	205.4 ksi
layer 5	=	205.4 ksi
layer 6	=	205.4 ksi
layer 7	=	205.4 ksi
layer 8	=	205.4 ksi
layer 9	=	205.4 ksi
layer 10	=	205.4 ksi
layer 11	=	205.4 ksi
layer 12	=	205.4 ksi
layer 13	=	205.4 ksi
layer 14	=	205.4 ksi

OK  
OK  
OK  
OK  
OK  
OK  
OK  
OK  
OK  
OK  
OK  
OK  
OK  
OK

force per strand =  $f_{pe} \cdot \text{strand area}$

		at midspan	at endspan
layer 1	=	14.6 kips	14.7 kips
layer 2	=	14.6 kips	14.7 kips
layer 3	=	14.6 kips	14.7 kips
layer 4	=	14.6 kips	14.7 kips
layer 5	=	14.6 kips	14.7 kips
layer 6	=	14.6 kips	
layer 7	=	14.6 kips	
layer 8	=	14.6 kips	
layer 9	=	14.6 kips	14.7 kips
layer 10	=		14.7 kips
layer 11	=		14.7 kips
layer 12	=		14.7 kips
layer 13	=		14.7 kips
layer 14	=		14.7 kips

		at midspan	at endspan
Total prestressing force after all losses	$P_{pe} =$	936.1 kips	939.4 kips
Final losses, % = $(\Delta f_{pT})/f_{pi}$			
layer 1	% =	19.3%	19.0%
layer 2	% =	19.3%	19.0%
layer 3	% =	19.3%	19.0%
layer 4	% =	19.3%	19.0%
layer 5	% =	19.3%	19.0%
layer 6	% =	19.3%	
layer 7	% =	19.3%	
layer 8	% =	19.3%	
layer 9	% =	19.3%	19.0%
layer 10	% =		19.0%
layer 11	% =		19.0%
layer 12	% =		19.0%
layer 13	% =		19.0%
layer 14	% =		19.0%
Average final losses, %	% =	19.3%	19.0%

### Stresses at Transfer

#### STRESS LIMITS FOR CONCRETE

Compression = $0.6f'_{ci}$	$f_{ci} =$	3.300 ksi
Tension		
without bonded reinforcement = $-0.0948\sqrt{f'_{ci}} \leq -0.2$	$=$	-0.200 ksi
with bonded auxiliary reinforcement = $-0.22\sqrt{f'_{ci}}$	$=$	-0.016 ksi

#### STRESSES AT TRANSFER LENGTH SECTION

Transfer Length = $60 \times (\text{strand diameter})$	$=$	1.9 ft	} Calcs for eccentricity (see 9.6.7.2)
Bending moment at transfer length	$M_g =$	87.7 ft-kips	
center of 12 strands to top fiber of beam at the end	$=$	7.00 in	
center of 12 strands to bottom fiber of beam at the harp point	$=$	11.00 in	
center of 12 strands and top fiber of beam at transfer length	$=$	9.84 in	
center of gravity of 32 strands and bottom fiber of beam	$=$	3.98 in	
center of gravity of all strands and the bottom fiber of beam at transfer length	$=$	15.24 in	
center of gravity of all strands and the bottom fiber of beam at the end	$=$	15.30 in	
Eccentricity of the strand group at transfer length:	$e_h =$	21.36 in	}
Eccentricity at end of beam:	$e =$	21.30 in	

$$f_t = \frac{P_i}{A} - \frac{P_i e}{S_t} + \frac{M_g}{S_t}$$

$$f_b = \frac{P_i}{A} + \frac{P_i e}{S_b} - \frac{M_g}{S_b}$$

		at midspan	at endspan	
Top stress at top fiber of beam	$f_t =$	-0.017 ksi	-0.017 ksi	OK
Bottom stress at bottom fiber of the beam	$f_b =$	2.906 ksi	2.906 ksi	OK

#### STRESSES AT HARP POINT

Bending moment due to beam weight at 0.3L	$M_g =$	1188.0 ft-kips		
Top stress at top fiber of beam	$f_t =$	0.173 ksi	0.169 ksi	OK
Bottom stress at bottom fiber of the beam	$f_b =$	2.736 ksi	2.621 ksi	OK

#### STRESSES AT MIDSPAN

Bending moment due to beam weight at 0.5L	$M_g =$	1414.3 ft-kips		
Top stress at top fiber of beam	$f_t =$	0.320 ksi	0.345 ksi	OK
Bottom stress at bottom fiber of the beam	$f_b =$	2.554 ksi	2.438 ksi	OK

#### HOLD-DOWN FORCES

assume stress in strand before losses =  $0.8f_u$

layer 1	$=$	227.4 ksi
layer 2	$=$	227.4 ksi
layer 3	$=$	227.4 ksi
layer 4	$=$	227.4 ksi
layer 5	$=$	227.4 ksi
layer 6	$=$	227.4 ksi
layer 7	$=$	227.4 ksi
layer 8	$=$	227.4 ksi
layer 9	$=$	227.4 ksi
layer 10	$=$	227.4 ksi
layer 11	$=$	227.4 ksi
layer 12	$=$	227.4 ksi
layer 13	$=$	227.4 ksi
layer 14	$=$	227.4 ksi

prestress force per strand before any losses:

layer 1	=	19.3 kips
layer 2	=	19.3 kips
layer 3	=	19.3 kips
layer 4	=	19.3 kips
layer 5	=	19.3 kips
layer 6	=	19.3 kips
layer 7	=	19.3 kips
layer 8	=	19.3 kips
layer 9	=	19.3 kips
layer 10	=	19.3 kips
layer 11	=	19.3 kips
layer 12	=	19.3 kips
layer 13	=	19.3 kips
layer 14	=	19.3 kips
Harp Angle	$\psi$ =	7.2 °

Hold-down force/strand

layer 1	=	2.5 kips/strand
layer 2	=	2.5 kips/strand
layer 3	=	2.5 kips/strand
layer 4	=	2.5 kips/strand
layer 5	=	2.5 kips/strand
layer 6	=	2.5 kips/strand
layer 7	=	2.5 kips/strand
layer 8	=	2.5 kips/strand
layer 9	=	2.5 kips/strand
layer 10	=	2.5 kips/strand
layer 11	=	2.5 kips/strand
layer 12	=	2.5 kips/strand
layer 13	=	2.5 kips/strand
layer 14	=	2.5 kips/strand
Total hold-down force	=	30.45 kips

### Stresses at Service Loads

#### STRESS LIMITS FOR CONCRETE

Compression:

Due to permanent loads for load combination Service I

for the precast beam	=	3.150 ksi
for deck	=	1.359 ksi

Due to permanent and transient loads for load combination Service I

for the precast beam	=	4.200 ksi
for deck	=	1.812 ksi

Tension:

Load Combination Service III

for the precast beam	=	-0.016 ksi
----------------------	---	------------

#### STRESSES AT MIDSPAN

Compression stresses at top fiber of beam	at midspan	at endspan		
$f_1 = \frac{P_{pe}}{A} - \frac{P_{pe}e}{S_1} + \frac{(M_w + M_d)}{S_1} + \frac{(M_w + M_d)}{S_{2g}}$	$f_{1g} =$	2.113 ksi	2.111 ksi	OK
Due to permanent loads				
$f_{1g} = \frac{P_M}{A} - \frac{P_{pe}e}{S_1} + \frac{(M_w + M_d)}{S_1} + \frac{(M_w - M_d)}{S_{2g}} + \frac{(M_{LL+I})}{S_{2g}}$	$f_{1g} =$	2.606 ksi	2.604 ksi	OK
Due to permanent loads and transient loads				
$f_{1g} = \frac{(M_w + M_d)}{S_{2c}}$	$f_{1c} =$	0.043 ksi	0.043 ksi	OK
Due to permanent loads				
$f_{1g} = \frac{(M_w + M_d + M_{LL+I})}{S_{2c}}$	$f_{1c} =$	0.500 ksi	0.500 ksi	OK
Due to permanent loads and transient loads				
<b>Tension stresses at top fiber of deck</b>	<b>at midspan</b>	<b>at endspan</b>		
$f_{1g} = \frac{P_{pe}}{A} + \frac{P_{pe}e}{S_2} - \frac{(M_w + M_d)}{S_2} - \frac{(M_w + M_d + 0.8 * M_{LL+I})}{S_{2c}}$	$f_{1g} =$	-0.845 ksi	-0.834 ksi	OK
Load Combination Service III				

**Strength Limit State**

POSITIVE MOMENT SECTION			
$M_u = 1.25DC+1.5DW+1.75(LL+IM)$	$M_u =$	8381.5 ft-kips	
effective length factor for compression members			
layer 1	k =	0.27	
layer 2	k =	0.27	
layer 3	k =	0.27	
layer 4	k =	0.27	
layer 5	k =	0.27	
layer 6	k =	0.27	
layer 7	k =	0.27	
layer 8	k =	0.27	
layer 9	k =	0.27	
layer 10	k =	0.27	
layer 11	k =	0.27	
layer 12	k =	0.27	
layer 13	k =	0.27	
layer 14	k =	0.27	
	c =	6.1 ft-kips	
average stress in prestressing steel			
layer 1	$f_{ps} =$	277.9 ksi	
layer 2	$f_{ps} =$	277.9 ksi	
layer 3	$f_{ps} =$	277.9 ksi	
layer 4	$f_{ps} =$	277.9 ksi	
layer 5	$f_{ps} =$	277.9 ksi	
layer 6	$f_{ps} =$	277.9 ksi	
layer 7	$f_{ps} =$	277.9 ksi	
layer 8	$f_{ps} =$	277.9 ksi	
layer 9	$f_{ps} =$	277.9 ksi	
layer 10	$f_{ps} =$	277.9 ksi	
layer 11	$f_{ps} =$	277.9 ksi	
layer 12	$f_{ps} =$	277.9 ksi	
layer 13	$f_{ps} =$	277.9 ksi	
layer 14	$f_{ps} =$	277.9 ksi	
nominal flexure resistance			
	a =	5.16 in	
$M_r = \Phi M_n, \Phi = 1.00$	$\Phi M_n =$	9068.2 ft-kips	OK
M=DC+W+LL+IM	M =	5833.6 ft-kips	OK
NEGATIVE MOMENT SECTION			
$M_u = 1.25DC+1.5DW+1.75(LL+IM)$	$M_u =$	-4837.2 ft-kips	
	a =	4.99 in	
	$\Phi M_n =$	4115.5 ft-kips	NOT OK
M=DC+W+LL+IM	M =	-2869.7 ft-kips	OK



### Shear Design

CRITICAL SECTION AT 0.59		
$V_u = 1.25DC + 1.5DW + 1.75(LL + IM)$	$V_u =$	405.0 kips
$M_u = 1.25DC + 1.5DW + 1.75(LL + IM)$	$M_u =$	-2684.4 ft-kips
or		
$V_u = 1.25DC + 1.5DW + 1.75(LL + IM)$	$V_u =$	364.8 kips
$M_u = 1.25DC + 1.5DW + 1.75(LL + IM)$	$M_u =$	-2877.0 ft-kips
max shear	$V_u =$	405.0 kips
max moment	$M_u =$	2877.0 ft-kips
Shear depth	$d_v =$	73.19 in
Applied factored normal force at the section	$N_u =$	0
Angle of diagonal compressive stresses	$\theta =$	36.00 °

### STRAIN IN FLEXURAL TENSION REINFORCEMENT

$$\epsilon_s = \frac{\frac{M_u}{d_v} + 0.5N_u \cot \theta + A_{ps} f_{ps}}{E_s A_s + E_p A_{ps}} \leq 0.002$$

	at midspan	at endspan
resultant compressive stress at centroid	$f_{pc} =$ 0.946 ksi	0.948 ksi

effective stress in prestressing strand after all losses

	at midspan	at endspan
layer 1	$f_{po} =$ 176.9 ksi	177.5 ksi
layer 2	$f_{po} =$ 176.9 ksi	177.5 ksi
layer 3	$f_{po} =$ 176.9 ksi	177.5 ksi
layer 4	$f_{po} =$ 176.9 ksi	177.5 ksi
layer 5	$f_{po} =$ 176.9 ksi	
layer 6	$f_{po} =$ 176.9 ksi	
layer 7	$f_{po} =$ 176.9 ksi	
layer 8	$f_{po} =$ 176.9 ksi	
layer 9	$f_{po} =$	177.5 ksi
layer 10	$f_{po} =$	177.5 ksi
layer 11	$f_{po} =$	177.5 ksi
layer 12	$f_{po} =$	177.5 ksi
layer 13	$f_{po} =$	177.5 ksi
layer 14	$f_{po} =$	177.5 ksi

strain in flexural tension

	at midspan	at endspan
layer 1	$\epsilon_x =$ 0.002000	0.002000
layer 2	$\epsilon_x =$ 0.002000	0.002000
layer 3	$\epsilon_x =$ 0.002000	0.002000
layer 4	$\epsilon_x =$ 0.002000	0.002000
layer 5	$\epsilon_x =$ 0.002000	
layer 6	$\epsilon_x =$ 0.002000	
layer 7	$\epsilon_x =$ 0.002000	
layer 8	$\epsilon_x =$ 0.002000	
layer 9	$\epsilon_x =$	0.002000
layer 10	$\epsilon_x =$	0.002000
layer 11	$\epsilon_x =$	0.002000
layer 12	$\epsilon_x =$	0.002000
layer 13	$\epsilon_x =$	0.002000
layer 14	$\epsilon_x =$	0.002000

### Deflection and Camber

	at midspan	at endspan
Deflection due to Prestressing Force at Transfer	$\Delta_p =$ 3.27 in	3.29 in
Deflection due to Beam Self-Weight at Transfer	$\Delta_g =$ -1.49 in	
Deflection due to Beam Self-Weight at Erection	$\Delta_g =$ -1.44 in	
Deflection due to Haunch and Deck	$\Delta_g =$ -1.95 in	

Deflection due to total self weight	$\Delta_{sw} =$ -0.11 in
-------------------------------------	--------------------------

Total Deflection at transfer	$\Delta =$ 1.79 in	1.81 in
Total Deflection at erection	$\Delta =$ 3.24 in	3.27 in

Live load deflection limit = span/800	$=$ 1.80 in
Deflection due to live load and impact	$\Delta_L =$ -0.89 in

OK

Deflection due to fire truck	$\Delta_L =$ -0.7986 in
Total Deflection after fire with fire truck	$\Delta =$ 2.3663 in

OK

**Location: Fire at Critical Negative Moment Sections**  
**Beam Design: 3/8" Strand**  
**Fire Exposure Status: 4 Hour**

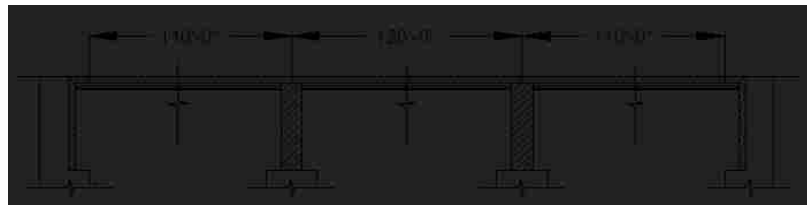
(PCI Bridge Design Manual Section 9.6)



**Material Properties**

CAST-IN-PLACE SLAB		
Actual Thickness	$t_{as} =$	8.0 in
Wearing Surface	$=$	0.5 in
Structural thickness = Actual - Wearing Surface	$t_s =$	7.5 in
Compressive Strength	$f'_c =$	2.83 ksi
Unit Weight	$w_c =$	150.0 pcf
Stress factor of compression block	$\beta_1 =$	0.85

BEAMS: AASHTO-PCI, BT-72 BULB-TEE		
Strength at release	$f'_{ci} =$	5.5 ksi
Strength at 28 days	$f'_c =$	7 ksi
Unit Weight	$w_c =$	150.0 pcf
Overall Beam Length:		
@ end spans	$L =$	110 ft
@ center span	$L =$	119 ft
Design Spans:		
Non-composite beam @ end spans	$L =$	109 ft
Non-composite beam @ center span	$L =$	118 ft
Composite beam @ end spans	$L =$	110 ft
Composite beam @ center span	$L =$	120 ft
Beam Spacing	$S =$	12 ft



**PRESTRESSING STRANDS**

Diameter of single strand	d =	0.4 in
Area of single strand	A =	0.085 in <sup>2</sup>

Temperature of Layer

layer 1 (bottom)	T =	68.00 °F
layer 2	T =	68.00 °F
layer 3	T =	68.00 °F
layer 4	T =	68.00 °F
layer 5	T =	68.00 °F
layer 6	T =	68.00 °F
layer 7	T =	68.00 °F
layer 8	T =	68.00 °F
layer 9	T =	68.00 °F
layer 10	T =	68.00 °F
layer 11	T =	68.00 °F
layer 12	T =	68.00 °F
layer 13	T =	68.00 °F
layer 14	T =	68.00 °F

Ultimate Strength

initial = 284 ksi

layer 1 (bottom)	f <sub>pu</sub> =	284 ksi
layer 2	f <sub>pu</sub> =	284 ksi
layer 3	f <sub>pu</sub> =	284 ksi
layer 4	f <sub>pu</sub> =	284 ksi
layer 5	f <sub>pu</sub> =	284 ksi
layer 6	f <sub>pu</sub> =	284 ksi
layer 7	f <sub>pu</sub> =	284 ksi
layer 8	f <sub>pu</sub> =	284 ksi
layer 9	f <sub>pu</sub> =	284 ksi
layer 10	f <sub>pu</sub> =	284 ksi
layer 11	f <sub>pu</sub> =	284 ksi
layer 12	f <sub>pu</sub> =	284 ksi
layer 13	f <sub>pu</sub> =	284 ksi
layer 14	f <sub>pu</sub> =	284 ksi

Yield Strength

initial = 257 ksi

layer 1 (bottom)	f <sub>py</sub> =	257 ksi
layer 2	f <sub>py</sub> =	257 ksi
layer 3	f <sub>py</sub> =	257 ksi
layer 4	f <sub>py</sub> =	257 ksi
layer 5	f <sub>py</sub> =	257 ksi
layer 6	f <sub>py</sub> =	257 ksi
layer 7	f <sub>py</sub> =	257 ksi
layer 8	f <sub>py</sub> =	257 ksi
layer 9	f <sub>py</sub> =	257 ksi
layer 10	f <sub>py</sub> =	257 ksi
layer 11	f <sub>py</sub> =	257 ksi
layer 12	f <sub>py</sub> =	257 ksi
layer 13	f <sub>py</sub> =	257 ksi
layer 14	f <sub>py</sub> =	257 ksi

**Stress Limits:**

before transfer ≤ 0.75f<sub>pu</sub> (initial = 213.2)

layer 1 (bottom)	f <sub>pl</sub> =	213.2 ksi
layer 2	f <sub>pl</sub> =	213.2 ksi
layer 3	f <sub>pl</sub> =	213.2 ksi
layer 4	f <sub>pl</sub> =	213.2 ksi
layer 5	f <sub>pl</sub> =	213.2 ksi
layer 6	f <sub>pl</sub> =	213.2 ksi
layer 7	f <sub>pl</sub> =	213.2 ksi
layer 8	f <sub>pl</sub> =	213.2 ksi
layer 9	f <sub>pl</sub> =	213.2 ksi
layer 10	f <sub>pl</sub> =	213.2 ksi
layer 11	f <sub>pl</sub> =	213.2 ksi
layer 12	f <sub>pl</sub> =	213.2 ksi
layer 13	f <sub>pl</sub> =	213.2 ksi
layer 14	f <sub>pl</sub> =	213.2 ksi

at service limit state (after all losses)  $\leq 0.80f_{py}$  (initial = 205.4)

layer 1 (bottom)	$f_{pe} =$	205.4 ksi
layer 2	$f_{pe} =$	205.4 ksi
layer 3	$f_{pe} =$	205.4 ksi
layer 4	$f_{pe} =$	205.4 ksi
layer 5	$f_{pe} =$	205.4 ksi
layer 6	$f_{pe} =$	205.4 ksi
layer 7	$f_{pe} =$	205.4 ksi
layer 8	$f_{pe} =$	205.4 ksi
layer 9	$f_{pe} =$	205.4 ksi
layer 10	$f_{pe} =$	205.4 ksi
layer 11	$f_{pe} =$	205.4 ksi
layer 12	$f_{pe} =$	205.4 ksi
layer 13	$f_{pe} =$	205.4 ksi
layer 14	$f_{pe} =$	205.4 ksi

Modulus of Elasticity

initial = 25898 ksi

layer 1 (bottom)	E =	25898.0 ksi
layer 2	E =	25898.0 ksi
layer 3	E =	25898.0 ksi
layer 4	E =	25898.0 ksi
layer 5	E =	25898.0 ksi
layer 6	E =	25898.0 ksi
layer 7	E =	25898.0 ksi
layer 8	E =	25898.0 ksi
layer 9	E =	25898.0 ksi
layer 10	E =	25898.0 ksi
layer 11	E =	25898.0 ksi
layer 12	E =	25898.0 ksi
layer 13	E =	25898.0 ksi
layer 14	E =	25898.0 ksi

#### MILD STEEL REINFORCING BARS

Yield Strength

Layer 1 (Bottom)	$f_y =$	60.0 ksi	100.00 °F
Layer 2 (Top)	$f_y =$	44.4 ksi	1430.00 °F

Modulus of Elasticity

Layer 1 (Bottom)	E =	29000.0 ksi
Layer 2 (Top)	E =	29000.0 ksi

Layer 1 (Bottom)

Area of steel at midspan (effective flange)	$A_{sm} =$	2.79 in <sup>2</sup>
Area of steel at endspan (effective flange)	$A_{se} =$	2.48 in <sup>2</sup>
Area of temperature and shrinkage steel (12" width)	$A_s =$	0.31 in <sup>2</sup>

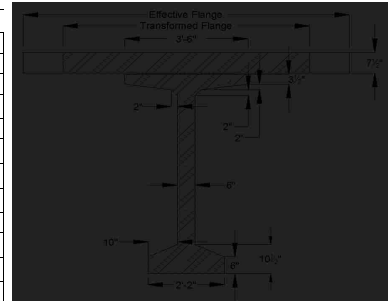
Layer 2 (Top)

Area of steel at midspan (effective flange)	$A_{sm} =$	12.6 in <sup>2</sup>
Area of steel at endspan (effective flange)	$A_{se} =$	12.4 in <sup>2</sup>
Area of temperature and shrinkage steel (12" width)	$A_s =$	0.2 in <sup>2</sup>

#### Cross-sectional Properties

##### NON-COMPOSITE BEAM

Area of cross-section of beam	A =	767.0 in <sup>2</sup>
Overall depth of beam	H =	72.0 in
Moment of Inertia	I =	539,947 in <sup>4</sup>
Distance from centroid to extreme bottom fiber	$y_b =$	36.6 in
Distance from centroid to extreme top fiber	$y_t =$	35.4 in
Section modulus for the extreme bottom fiber	$S_b =$	14915.0 in <sup>3</sup>
Section modulus for the extreme top fiber	$S_t =$	15421.0 in <sup>3</sup>
Weight	$W_t =$	799.0 plf
Modulus of Elasticity = $33000 \cdot (W_c / 1.5) \cdot (\sqrt{f_c})$		
cast-in-place concrete deck	$E_{cs} =$	3225 ksi
precast beam at release	$E_{ci} =$	4496 ksi
precast beam at service loads	$E_c =$	5072 ksi



**COMPOSITE BEAM AT MIDSPAN**

Effective Flange Width	$b_f =$	111.0 in	*min of three criteria
Modular Ratio = $E_{cs}/E_c$	$n =$	0.6358	
Transformed flange width	$=$	70.6 in	
Transformed flange area	$=$	529.3 in <sup>2</sup>	
Transformed haunch width	$=$	26.7 in	
Transformed haunch area	$=$	13.4 in <sup>2</sup>	
Deck-distance to top fiber	$y_t =$	5.83 in	

	Transformed Area	$y_b$	$Ay_b$	$A(y_{bc}-y_b)^2$	I	$I + A(y_{bc}-y_b)^2$
Beam	767.0 in <sup>2</sup>	36.60 in	28,072.2 in <sup>3</sup>	185,416 in <sup>4</sup>	539,947 in <sup>4</sup>	725,363 in <sup>4</sup>
Haunch	13.4 in <sup>2</sup>	72.25 in	964.7 in <sup>3</sup>	5,396 in <sup>4</sup>	0.28 in <sup>4</sup>	5,396 in <sup>4</sup>
Deck	529.3 in <sup>2</sup>	74.17 in	39,260.6 in <sup>3</sup>	256,709 in <sup>4</sup>	692 in <sup>4</sup>	257,400 in <sup>4</sup>
Total	1309.7 in <sup>2</sup>		68,297.5 in <sup>3</sup>			988,159 in <sup>4</sup>

Total area of Composite Section	$A_c =$	1310 in <sup>2</sup>
Overall Depth of the Composite Section	$h_c =$	80 in
Moment of Inertia	$I_c =$	988,159 in <sup>4</sup>
Distance from centroid to extreme <u>bottom</u> fiber of beam	$y_{bc} =$	52.15 in
Distance from centroid to extreme <u>top</u> fiber of beam	$y_{tg} =$	19.85 in
Distance from centroid to extreme <u>top</u> fiber of slab	$y_{tc} =$	27.85 in
Section modulus for the extreme <u>bottom</u> fiber of beam	$S_{bc} =$	18,949.1 in <sup>3</sup>
Section modulus for the extreme <u>top</u> fiber of beam	$S_{tg} =$	49,776.4 in <sup>3</sup>
Section modulus for the extreme <u>top</u> fiber slab	$S_{tc} =$	55,799.1 in <sup>3</sup>

**COMPOSITE BEAM AT ENDSPAN**

Effective Flange Width	$b_f =$	106.6 in	*min of three criteria
Modular Ratio = $E_{cs}/E_c$	$n =$	0.6358	
Transformed flange width	$=$	67.8 in	
Transformed flange area	$=$	508.3 in <sup>2</sup>	
Transformed haunch width	$=$	26.7 in	
Transformed haunch area	$=$	13.4 in <sup>2</sup>	
Deck-distance to top fiber	$y_{td} =$	5.83 in	

	Transformed Area	$y_t$	$Ay_t$	$A(y_{bc}-y_t)^2$	I	$I + A(y_{bc}-y_t)^2$
Beam	767.0 in <sup>2</sup>	36.60 in	28,072.2 in <sup>3</sup>	249,350 in <sup>4</sup>	539,947 in <sup>4</sup>	789,297 in <sup>4</sup>
Haunch	13.4 in <sup>2</sup>	72.25 in	964.7 in <sup>3</sup>	4,341 in <sup>4</sup>	0.28 in <sup>4</sup>	4,341 in <sup>4</sup>
Deck	508.3 in <sup>2</sup>	78.33 in	39,819.0 in <sup>3</sup>	165,263 in <sup>4</sup>	666 in <sup>4</sup>	165,929 in <sup>4</sup>
Total	1288.7 in <sup>2</sup>		68,856.0 in <sup>3</sup>			959,567 in <sup>4</sup>

Total area of Composite Section	$A_c =$	1289 in <sup>2</sup>
Overall Depth of the Composite Section	$h_c =$	80 in
Moment of Inertia	$I_c =$	959,567 in <sup>4</sup>
Distance from centroid to extreme <u>bottom</u> fiber of beam	$y_{bc} =$	53.43 in
Distance from centroid to extreme <u>top</u> fiber of beam	$y_{tg} =$	18.57 in
Distance from centroid to extreme <u>top</u> fiber of slab	$y_{tc} =$	26.57 in
Section modulus for the extreme <u>bottom</u> fiber of beam	$S_{bc} =$	17,959.2 in <sup>3</sup>
Section modulus for the extreme <u>top</u> fiber of beam	$S_{tg} =$	51,674.2 in <sup>3</sup>
Section modulus for the extreme <u>top</u> fiber slab	$S_{tc} =$	36,115.3 in <sup>3</sup>

**Shear Forces and Bending Moments**

**DEAD LOADS**

Beam self-weight	$W_{beam} =$	0.799 k/f
8 in. deck weight	$W_{deck} =$	1.200 k/f
1/2 in. haunch weight	$W_{haunch} =$	0.022 k/f

**LRFD Specifications: Art. 4.6.2.2.1**

Width of Deck Constant		OK
Number of beams is not less than four $N_b =$	4	OK
Roadway part of the overhang, $d_s \leq 3.0$ ft, $d_s =$	1.5	OK
Curvature in plans is less than 4° =	0	OK
Cross-section of the bridge is consistent with one of the cross sections given by LRFD specs		OK

Barrier and wearing surface loads are equally distributed among the 4 beams

Barrier Wt	$W_t =$	0.150 k/f
Dead load of future wearing surface	$DW =$	0.263 k/f

LIVE LOADS		
Fire truck live load front load (Point A)	$P_{live} =$	48.0 kips
Fire truck live load back load (Point B)	$P_{live} =$	22.0 kips
distance between two loads		19.2 ft
distance from nearest edge to point A	$x_a =$	59.0 ft
distance from nearest edge to point B	$x_b =$	39.8 ft
LRFD Specifications: Art. 4.6.2.2.1		
Width of Deck Constant		OK
Number of beams is not less than four $N_b =$	4	OK
Beams are parallel and approximately of the same stiffness		OK
Roadway part of the overhang, $d_s \leq 3.0$ ft, $d_e =$	1.5	OK
Curvature in plans is less than $4^\circ =$	0	OK

Barrier and wearing surface loads are equally distributed among the 4 beams

Bridge Type-- "k" (LRFD Table 4.6.2.2.1-1)		
Number of design lanes = $w/12$	=	3 lanes

#### Distribution Factor for Bending Moment:

Beams spacing	$S =$	12.0 ft
Depth of concrete slab	$t_s =$	7.5 in
Beam Span	$L =$	120.0 ft
Number of Beams	$N_b =$	4
Modular ratio between beam & deck materials	$n =$	1.5727
Longitudinal stiffness parameter	$K_g =$	2,745,627.23 in <sup>4</sup>

at center span:		
$DFM = 3.75 \left( \frac{S}{9.5} \right)^{0.1} * \left( \frac{S}{L} \right)^{0.2} * \left( \frac{K_g}{2 * L * N_b^3} \right)^{0.1}$		
DFM =		0.919 lanes/beam

0.905 Controls

one design lane loaded:		
$DFM = 0.75 + \left( \frac{S}{4} \right)^{0.4} + \left( \frac{S}{L} \right)^{0.3} + \left( \frac{K_g}{2 * L * N_b^3} \right)^{0.1}$		
DFM =		0.623 lanes/beam

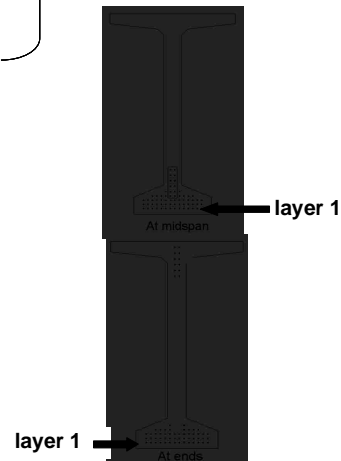
#### Distribution Factor for Shear Force

both end spans and center span:		
$DFV = 0.2 + \left( \frac{S}{12} \right) - \left( \frac{S}{35} \right)^2$		
DFV =		1.082 lanes/beam

1.082 Controls

one design lane loaded:		
$DFV = 0.36 + \left( \frac{S}{25} \right)$		
DFV =		0.840 lanes/beam

from bottom	At Midspan		At Ends	
	No. of	Distance from Bottom	No. of	Distance from Bottom
layer 1	14	2	14	2
layer 2	14	3.5	14	3.5
layer 3	14	5	14	5
layer 4	10	6.5	8	6.5
layer 5	4	8	2	8
layer 6	2	10	-	-
layer 7	2	12	-	-
layer 8	2	14	-	-
layer 9	2	16	2	60
layer 10	-	-	2	62
layer 11	-	-	2	64
layer 12	-	-	2	66
layer 13	-	-	2	68
layer 14	-	-	2	70
	64		64	
Harped Strand Group (included in above totals)				
layer 3	2	6		
layer 4	2	8		
layer 5	2	10		
layer 6	2	12		
layer 7	2	14		
layer 8	2	16		



distance from the center of gravity of strands to the bottom fiber of the beam = 7% of the beam depth	$y_{bs} =$	5.44 in
strand eccentricity at midspan = $(y_c - y_{bs})$	$e_c =$	31.16 in

## Prestress Losses

### ELASTIC SHORTENING

assumed loss	=	6.00%
Force per strand at transfer		
layer 1	=	17.0 kips
layer 2	=	17.0 kips
layer 3	=	17.0 kips
layer 4	=	17.0 kips
layer 5	=	17.0 kips
layer 6	=	17.0 kips
layer 7	=	17.0 kips
layer 8	=	17.0 kips
layer 9	=	17.0 kips
layer 10	=	17.0 kips
layer 11	=	17.0 kips
layer 12	=	17.0 kips
layer 13	=	17.0 kips
layer 14	=	17.0 kips

		at midspan	at endspan
Total prestressing force at release	$P_1 =$	1088.0 kips	1054.0 kips
Sum of concrete stresses at the center of gravity of prestressing tendons due to prestressing force at transfer and the self-weight of the member at sections of maximum moment	$f_{cgp} =$	2.412 ksi	2.307 ksi
Loss due to shortening		at midspan	at endspan
layer 1	$\Delta f_{pES} =$	13.9 ksi	13.3 ksi
layer 2	$\Delta f_{pES} =$	13.9 ksi	13.3 ksi
layer 3	$\Delta f_{pES} =$	13.9 ksi	13.3 ksi
layer 4	$\Delta f_{pES} =$	13.9 ksi	13.3 ksi
layer 5	$\Delta f_{pES} =$	13.9 ksi	13.3 ksi
layer 6	$\Delta f_{pES} =$	13.9 ksi	
layer 7	$\Delta f_{pES} =$	13.9 ksi	
layer 8	$\Delta f_{pES} =$	13.9 ksi	
layer 9	$\Delta f_{pES} =$	13.9 ksi	13.3 ksi
layer 10	$\Delta f_{pES} =$		13.3 ksi
layer 11	$\Delta f_{pES} =$		13.3 ksi
layer 12	$\Delta f_{pES} =$		13.3 ksi
layer 13	$\Delta f_{pES} =$		13.3 ksi
layer 14	$\Delta f_{pES} =$		13.3 ksi

### SHRINKAGE

Shrinkage = $(17 - 0.15 \cdot \text{Relative Humidity})$	$\Delta f_{BSR} =$	6.5 ksi	← assume relative humidity = 70%
--	--------------------	---------	----------------------------------

### CREEP OF CONCRETE

Change of stresses at center of gravity of prestressing due to permanent loads except the loads acting at time of applying prestressing force, calculated at the same section as $f_{cgp}$	$\Delta f_{csp} =$	1.594 ksi	
loss due to creep	$\Delta f_{PCR} =$	at midspan 17.8 ksi	at endspan 16.5 ksi

**RELAXATION OF PRESTRESSING STRANDS**

loss due to relaxation after transfer		at midspan	at endspan
layer 1	$\Delta f_{PR2} =$	2.9 ksi	2.9 ksi
layer 2	$\Delta f_{PR2} =$	2.9 ksi	2.9 ksi
layer 3	$\Delta f_{PR2} =$	2.9 ksi	2.9 ksi
layer 4	$\Delta f_{PR2} =$	2.9 ksi	2.9 ksi
layer 5	$\Delta f_{PR2} =$	2.9 ksi	2.9 ksi
layer 6	$\Delta f_{PR2} =$	2.9 ksi	
layer 7	$\Delta f_{PR2} =$	2.9 ksi	
layer 8	$\Delta f_{PR2} =$	2.9 ksi	
layer 9	$\Delta f_{PR2} =$	2.9 ksi	2.9 ksi
layer 10	$\Delta f_{PR2} =$		2.9 ksi
layer 11	$\Delta f_{PR2} =$		2.9 ksi
layer 12	$\Delta f_{PR2} =$		2.9 ksi
layer 13	$\Delta f_{PR2} =$		2.9 ksi
layer 14	$\Delta f_{PR2} =$		2.9 ksi

**TOTAL LOSSES AT TRANSFER**

total loss  $\Delta f_{pES} = \Delta f_{pl}$

stress in tendons after transfer  $f_{pt} = f_{pr} - \Delta f_{pl}$

		at midspan	at endspan
layer 1	$f_{pt} =$	199.3 ksi	199.9 ksi
layer 2	$f_{pt} =$	199.3 ksi	199.9 ksi
layer 3	$f_{pt} =$	199.3 ksi	199.9 ksi
layer 4	$f_{pt} =$	199.3 ksi	199.9 ksi
layer 5	$f_{pt} =$	199.3 ksi	199.9 ksi
layer 6	$f_{pt} =$	199.3 ksi	
layer 7	$f_{pt} =$	199.3 ksi	
layer 8	$f_{pt} =$	199.3 ksi	
layer 9	$f_{pt} =$	199.3 ksi	199.9 ksi
layer 10	$f_{pt} =$		199.9 ksi
layer 11	$f_{pt} =$		199.9 ksi
layer 12	$f_{pt} =$		199.9 ksi
layer 13	$f_{pt} =$		199.9 ksi
layer 14	$f_{pt} =$		199.9 ksi

force per strand =  $f_{pt} \cdot \text{strand area}$

		at midspan	at endspan
layer 1	=	16.9 kips	17.0 kips
layer 2	=	16.9 kips	17.0 kips
layer 3	=	16.9 kips	17.0 kips
layer 4	=	16.9 kips	17.0 kips
layer 5	=	16.9 kips	17.0 kips
layer 6	=	16.9 kips	
layer 7	=	16.9 kips	
layer 8	=	16.9 kips	
layer 9	=	16.9 kips	17.0 kips
layer 10	=		17.0 kips
layer 11	=		17.0 kips
layer 12	=		17.0 kips
layer 13	=		17.0 kips
layer 14	=		17.0 kips

Total prestressing force after transfer

Initial loss =  $(\Delta f_{pl}) / (f_{pr})$

		at midspan	at endspan
layer 1	% =	6.5%	6.2%
layer 2	% =	6.5%	6.2%
layer 3	% =	6.5%	6.2%
layer 4	% =	6.5%	6.2%
layer 5	% =	6.5%	6.2%
layer 6	% =	6.5%	
layer 7	% =	6.5%	
layer 8	% =	6.5%	
layer 9	% =	6.5%	6.2%
layer 10	% =		6.2%
layer 11	% =		6.2%
layer 12	% =		6.2%
layer 13	% =		6.2%
layer 14	% =		6.2%

OK  
OK  
OK  
OK  
OK  
OK  
OK  
OK  
OK  
OK  
OK  
OK  
OK  
OK



**TOTAL LOSSES AT SERVICE LOADS**

Total Losses		at midspan	at endspan
layer 1	$\Delta f_{pT} =$	41.1 ksi	40.5 ksi
layer 2	$\Delta f_{pT} =$	41.1 ksi	40.5 ksi
layer 3	$\Delta f_{pT} =$	41.1 ksi	40.5 ksi
layer 4	$\Delta f_{pT} =$	41.1 ksi	40.5 ksi
layer 5	$\Delta f_{pT} =$	41.1 ksi	40.5 ksi
layer 6	$\Delta f_{pT} =$	41.1 ksi	
layer 7	$\Delta f_{pT} =$	41.1 ksi	
layer 8	$\Delta f_{pT} =$	41.1 ksi	
layer 9	$\Delta f_{pT} =$	41.1 ksi	40.5 ksi
layer 10	$\Delta f_{pT} =$		40.5 ksi
layer 11	$\Delta f_{pT} =$		40.5 ksi
layer 12	$\Delta f_{pT} =$		40.5 ksi
layer 13	$\Delta f_{pT} =$		40.5 ksi
layer 14	$\Delta f_{pT} =$		40.5 ksi

Stress in tendon after all losses = $f_{pi} - \Delta f_{pi}$		at midspan	at endspan
layer 1	$f_{pe} =$	172.1 ksi	172.7 ksi
layer 2	$f_{pe} =$	172.1 ksi	172.7 ksi
layer 3	$f_{pe} =$	172.1 ksi	172.7 ksi
layer 4	$f_{pe} =$	172.1 ksi	172.7 ksi
layer 5	$f_{pe} =$	172.1 ksi	172.7 ksi
layer 6	$f_{pe} =$	172.1 ksi	
layer 7	$f_{pe} =$	172.1 ksi	
layer 8	$f_{pe} =$	172.1 ksi	
layer 9	$f_{pe} =$	172.1 ksi	172.7 ksi
layer 10	$f_{pe} =$		172.7 ksi
layer 11	$f_{pe} =$		172.7 ksi
layer 12	$f_{pe} =$		172.7 ksi
layer 13	$f_{pe} =$		172.7 ksi
layer 14	$f_{pe} =$		172.7 ksi

check prestressing stress limit at service limit state:  $f_{pe} \leq 0.8 \cdot f_{py}$

layer 1	=	205.4 ksi
layer 2	=	205.4 ksi
layer 3	=	205.4 ksi
layer 4	=	205.4 ksi
layer 5	=	205.4 ksi
layer 6	=	205.4 ksi
layer 7	=	205.4 ksi
layer 8	=	205.4 ksi
layer 9	=	205.4 ksi
layer 10	=	205.4 ksi
layer 11	=	205.4 ksi
layer 12	=	205.4 ksi
layer 13	=	205.4 ksi
layer 14	=	205.4 ksi

OK  
OK  
OK  
OK  
OK  
OK  
OK  
OK  
OK  
OK  
OK  
OK  
OK  
OK

force per strand =  $f_{pe} \cdot \text{strand area}$

		at midspan	at endspan
layer 1	=	14.6 kips	14.7 kips
layer 2	=	14.6 kips	14.7 kips
layer 3	=	14.6 kips	14.7 kips
layer 4	=	14.6 kips	14.7 kips
layer 5	=	14.6 kips	14.7 kips
layer 6	=	14.6 kips	
layer 7	=	14.6 kips	
layer 8	=	14.6 kips	
layer 9	=	14.6 kips	14.7 kips
layer 10	=		14.7 kips
layer 11	=		14.7 kips
layer 12	=		14.7 kips
layer 13	=		14.7 kips
layer 14	=		14.7 kips

		at midspan	at endspan
Total prestressing force after all losses	$P_{pe} =$	936.2 kips	939.5 kips
Final losses, % = $(\Delta f_{pr})/f_{pi}$			
layer 1	% =	19.3%	19.0%
layer 2	% =	19.3%	19.0%
layer 3	% =	19.3%	19.0%
layer 4	% =	19.3%	19.0%
layer 5	% =	19.3%	19.0%
layer 6	% =	19.3%	
layer 7	% =	19.3%	
layer 8	% =	19.3%	
layer 9	% =	19.3%	19.0%
layer 10	% =		19.0%
layer 11	% =		19.0%
layer 12	% =		19.0%
layer 13	% =		19.0%
layer 14	% =		19.0%
Average final losses, %	% =	19.3%	19.0%

### Stresses at Transfer

#### STRESS LIMITS FOR CONCRETE

Compression = $0.6f'_{ci}$	$f_{ci} =$	3.300 ksi
Tension		
without bonded reinforcement = $-0.0948\sqrt{f'_{ci}} \leq -0.2$	$=$	-0.200 ksi
with bonded auxiliary reinforcement = $-0.22\sqrt{f'_{ci}}$	$=$	-0.016 ksi

#### STRESSES AT TRANSFER LENGTH SECTION

Transfer Length = $60 \times (\text{strand diameter})$	$=$	1.9 ft	} Calcs for eccentricity (see 9.6.7.2)
Bending moment at transfer length	$M_g =$	87.7 ft-kips	
center of 12 strands to top fiber of beam at the end	$=$	7.00 in	
center of 12 strands to bottom fiber of beam at the harp point	$=$	11.00 in	
center of 12 strands and top fiber of beam at transfer length	$=$	9.84 in	
center of gravity of 32 strands and bottom fiber of beam	$=$	3.98 in	
center of gravity of all strands and the bottom fiber of beam at transfer length	$=$	15.24 in	
center of gravity of all strands and the bottom fiber of beam at the end	$=$	15.30 in	
Eccentricity of the strand group at transfer length:	$e_h =$	21.36 in	}
Eccentricity at end of beam:	$e =$	21.30 in	

$$f_t = \frac{P_i}{A} - \frac{P_i e}{S_t} + \frac{M_g}{S_t}$$

$$f_b = \frac{P_i}{A} + \frac{P_i e}{S_b} - \frac{M_g}{S_b}$$

		at midspan	at endspan	
Top stress at top fiber of beam	$f_t =$	-0.017 ksi	-0.017 ksi	OK
Bottom stress at bottom fiber of the beam	$f_b =$	2.906 ksi	2.906 ksi	OK

#### STRESSES AT HARP POINT

Bending moment due to beam weight at 0.3L	$M_g =$	1188.0 ft-kips		
Top stress at top fiber of beam	$f_t =$	0.173 ksi	0.169 ksi	OK
Bottom stress at bottom fiber of the beam	$f_b =$	2.736 ksi	2.621 ksi	OK

#### STRESSES AT MIDSPAN

Bending moment due to beam weight at 0.5L	$M_g =$	1414.3 ft-kips		
Top stress at top fiber of beam	$f_t =$	0.320 ksi	0.345 ksi	OK
Bottom stress at bottom fiber of the beam	$f_b =$	2.554 ksi	2.438 ksi	OK

#### HOLD-DOWN FORCES

assume stress in strand before losses =  $0.8f_u$

layer 1	$=$	227.4 ksi
layer 2	$=$	227.4 ksi
layer 3	$=$	227.4 ksi
layer 4	$=$	227.4 ksi
layer 5	$=$	227.4 ksi
layer 6	$=$	227.4 ksi
layer 7	$=$	227.4 ksi
layer 8	$=$	227.4 ksi
layer 9	$=$	227.4 ksi
layer 10	$=$	227.4 ksi
layer 11	$=$	227.4 ksi
layer 12	$=$	227.4 ksi
layer 13	$=$	227.4 ksi
layer 14	$=$	227.4 ksi

prestress force per strand before any losses:

layer 1	=	19.3 kips
layer 2	=	19.3 kips
layer 3	=	19.3 kips
layer 4	=	19.3 kips
layer 5	=	19.3 kips
layer 6	=	19.3 kips
layer 7	=	19.3 kips
layer 8	=	19.3 kips
layer 9	=	19.3 kips
layer 10	=	19.3 kips
layer 11	=	19.3 kips
layer 12	=	19.3 kips
layer 13	=	19.3 kips
layer 14	=	19.3 kips
Harp Angle	$\psi$ =	7.2 °

Hold-down force/strand

layer 1	=	2.5 kips/strand
layer 2	=	2.5 kips/strand
layer 3	=	2.5 kips/strand
layer 4	=	2.5 kips/strand
layer 5	=	2.5 kips/strand
layer 6	=	2.5 kips/strand
layer 7	=	2.5 kips/strand
layer 8	=	2.5 kips/strand
layer 9	=	2.5 kips/strand
layer 10	=	2.5 kips/strand
layer 11	=	2.5 kips/strand
layer 12	=	2.5 kips/strand
layer 13	=	2.5 kips/strand
layer 14	=	2.5 kips/strand
Total hold-down force	=	30.45 kips

### Stresses at Service Loads

#### STRESS LIMITS FOR CONCRETE

Compression:

Due to permanent loads for load combination Service I

for the precast beam	=	3.150 ksi
for deck	=	1.274 ksi

Due to permanent and transient loads for load combination Service I

for the precast beam	=	4.200 ksi
for deck	=	1.698 ksi

Tension:

Load Combination Service III

for the precast beam	=	-0.016 ksi
----------------------	---	------------

#### STRESSES AT MIDSPAN

Compression stresses at top fiber of beam	at midspan	at endspan		
$f_1 = \frac{F_{pm}}{A} - \frac{F_{pe}e}{S_1} + \frac{(M_f + M_{s1})}{S_1} + \frac{(M_{ps} + M_b)}{S_{1g}}$	$f_{1g} =$	2.114 ksi	2.112 ksi	OK
Due to permanent loads				
$f_{1g} = \frac{P_M}{A} - \frac{P_{pe}e}{S_1} + \frac{(M_f + M_{s1})}{S_1} + \frac{(M_{ps} + M_b)}{S_{1g}} + \frac{(M_{LL+I})}{S_{1g}}$	$f_{1g} =$	2.624 ksi	2.622 ksi	OK
Due to permanent loads and transient loads				
Compression stresses at top fiber of deck	at midspan	at endspan		
$f_{1g} = \frac{(M_{ps} + M_b)}{S_{1g}}$	$f_{1g} =$	0.043 ksi	0.043 ksi	OK
Due to permanent loads				
$f_{1g} = \frac{(M_{ps} + M_b + M_{LL+I})}{S_{1g}}$	$f_{1g} =$	0.498 ksi	0.498 ksi	OK
Due to permanent loads and transient loads				
Tension stresses at top fiber of deck	at midspan	at endspan		
$f_{1g} = \frac{P_{pr}}{A} + \frac{P_{pe}e}{S_b} - \frac{(M_f + M_{s1})}{S_b} - \frac{(M_{ps} + M_b + 0.8 \times M_{LL+I})}{S_{1g}}$	$f_{1g} =$	-0.852 ksi	-0.841 ksi	OK
Load Combination Service III				

**Strength Limit State**

POSITIVE MOMENT SECTION		
$M_u = 1.25DC+1.5DW+1.75(LL+IM)$	$M_u =$	8381.5 ft-kips

effective length factor for compression members

layer 1	k =	0.27
layer 2	k =	0.27
layer 3	k =	0.27
layer 4	k =	0.27
layer 5	k =	0.27
layer 6	k =	0.27
layer 7	k =	0.27
layer 8	k =	0.27
layer 9	k =	0.27
layer 10	k =	0.27
layer 11	k =	0.27
layer 12	k =	0.27
layer 13	k =	0.27
layer 14	k =	0.27
	c =	6.5 ft-kips

average stress in prestressing steel

layer 1	$f_{ps} =$	277.5 ksi
layer 2	$f_{ps} =$	277.5 ksi
layer 3	$f_{ps} =$	277.5 ksi
layer 4	$f_{ps} =$	277.5 ksi
layer 5	$f_{ps} =$	277.5 ksi
layer 6	$f_{ps} =$	277.5 ksi
layer 7	$f_{ps} =$	277.5 ksi
layer 8	$f_{ps} =$	277.5 ksi
layer 9	$f_{ps} =$	277.5 ksi
layer 10	$f_{ps} =$	277.5 ksi
layer 11	$f_{ps} =$	277.5 ksi
layer 12	$f_{ps} =$	277.5 ksi
layer 13	$f_{ps} =$	277.5 ksi
layer 14	$f_{ps} =$	277.5 ksi

nominal flexure resistance

	a =	5.50 in
$M_r = \Phi M_n, \Phi = 1.00$	$\Phi M_n =$	9033.5 ft-kips
M=DC+W+LL+IM	M =	5833.6 ft-kips

OK

OK

NEGATIVE MOMENT SECTION		
$M_u = 1.25DC+1.5DW+1.75(LL+IM)$	$M_u =$	-4837.2 ft-kips

	a =	4.70 in
	$\Phi M_n =$	3876.2 ft-kips
M=DC+W+LL+IM	M =	-2869.7 ft-kips

NOT OK

OK

### Shear Design

CRITICAL SECTION AT 0.59		
$V_u = 1.25DC + 1.5DW + 1.75(LL + IM)$	$V_u =$	405.0 kips
$M_u = 1.25DC + 1.5DW + 1.75(LL + IM)$	$M_u =$	-2684.4 ft-kips
or		
$V_u = 1.25DC + 1.5DW + 1.75(LL + IM)$	$V_u =$	364.8 kips
$M_u = 1.25DC + 1.5DW + 1.75(LL + IM)$	$M_u =$	-2877.0 ft-kips
max shear	$V_u =$	405.0 kips
max moment	$M_u =$	2877.0 ft-kips
Shear depth	$d_v =$	73.19 in
Applied factored normal force at the section	$N_u =$	0
Angle of diagonal compressive stresses	$\theta =$	36.00 °

### STRAIN IN FLEXURAL TENSION REINFORCEMENT

$$\epsilon_x = \frac{\frac{M_u}{d_v} + 0.5A'_s + 0.25A_s \cot \theta + A_{ps} f_{ps}}{E_s A_s + E_p A_{ps}} \leq 0.002$$

	at midspan	at endspan
resultant compressive stress at centroid	$f_{pc} =$ 0.952 ksi	0.955 ksi

effective stress in prestressing strand after all losses

	at midspan	at endspan
layer 1	$f_{po} =$ 177.0 ksi	177.6 ksi
layer 2	$f_{po} =$ 177.0 ksi	177.6 ksi
layer 3	$f_{po} =$ 177.0 ksi	177.6 ksi
layer 4	$f_{po} =$ 177.0 ksi	177.6 ksi
layer 5	$f_{po} =$ 177.0 ksi	
layer 6	$f_{po} =$ 177.0 ksi	
layer 7	$f_{po} =$ 177.0 ksi	
layer 8	$f_{po} =$ 177.0 ksi	
layer 9	$f_{po} =$	177.6 ksi
layer 10	$f_{po} =$	177.6 ksi
layer 11	$f_{po} =$	177.6 ksi
layer 12	$f_{po} =$	177.6 ksi
layer 13	$f_{po} =$	177.6 ksi
layer 14	$f_{po} =$	177.6 ksi

strain in flexural tension

	at midspan	at endspan
layer 1	$\epsilon_x =$ 0.002000	0.002000
layer 2	$\epsilon_x =$ 0.002000	0.002000
layer 3	$\epsilon_x =$ 0.002000	0.002000
layer 4	$\epsilon_x =$ 0.002000	0.002000
layer 5	$\epsilon_x =$ 0.002000	
layer 6	$\epsilon_x =$ 0.002000	
layer 7	$\epsilon_x =$ 0.002000	
layer 8	$\epsilon_x =$ 0.002000	
layer 9	$\epsilon_x =$	0.002000
layer 10	$\epsilon_x =$	0.002000
layer 11	$\epsilon_x =$	0.002000
layer 12	$\epsilon_x =$	0.002000
layer 13	$\epsilon_x =$	0.002000
layer 14	$\epsilon_x =$	0.002000

### Deflection and Camber

	at midspan	at endspan
Deflection due to Prestressing Force at Transfer	$\Delta_p =$ 3.27 in	3.29 in
Deflection due to Beam Self-Weight at Transfer	$\Delta_g =$ -1.49 in	
Deflection due to Beam Self-Weight at Erection	$\Delta_g =$ -1.44 in	
Deflection due to Haunch and Deck	$\Delta_g =$ -1.95 in	

Deflection due to total self weight	$\Delta_{sw} =$ -0.11 in
-------------------------------------	--------------------------

Total Deflection at transfer	$\Delta =$ 1.79 in	1.81 in
Total Deflection at erection	$\Delta =$ 3.24 in	3.27 in

Live load deflection limit = span/800	$=$ 1.80 in
Deflection due to live load and impact	$\Delta_L =$ -0.90 in

OK

Deflection due to fire truck	$\Delta_f =$ -0.8130 in
Total Deflection after fire with fire truck	$\Delta =$ 2.3519 in

OK

**Location: Fire above Deck Between Girders**  
**Beam Design: 1/2" Strand**  
**Fire Exposure Status: Undamaged**

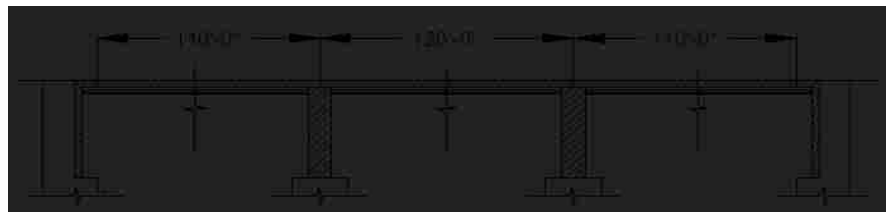
(PCI Bridge Design Manual Section 9.6)



**Material Properties**

CAST-IN-PLACE SLAB		
Actual Thickness	$t_{as} =$	8.0 in
Wearing Surface	$=$	0.5 in
Structural thickness = Actual - Wearing Surface	$t_s =$	7.5 in
Compressive Strength	$f'_c =$	4.00 ksi
Unit Weight	$w_c =$	150.0 pcf
Stress factor of compression block	$\beta_1 =$	0.85

BEAMS: AASHTO-PCI, BT-72 BULB-TEE		
Strength at release	$f'_{ci} =$	5.5 ksi
Strength at 28 days	$f'_c =$	7 ksi
Unit Weight	$w_c =$	150.0 pcf
Overall Beam Length:		
@ end spans	$L =$	110 ft
@ center span	$L =$	119 ft
Design Spans:		
Non-composite beam @ end spans	$L =$	109 ft
Non-composite beam @ center span	$L =$	118 ft
Composite beam @ end spans	$L =$	110 ft
Composite beam @ center span	$L =$	120 ft
Beam Spacing	$S =$	12 ft



**PRESTRESSING STRANDS**

Diameter of single strand	d =	0.5 in
Area of single strand	A =	0.153 in <sup>2</sup>
Temperature of Layer		
	layer 1 (bottom)	T = 68.00 °F
	layer 2	T = 68.00 °F
	layer 3	T = 68.00 °F
	layer 4	T = 68.00 °F
	layer 5	T = 68.00 °F
	layer 6	T = 68.00 °F
	layer 7	T = 68.00 °F
	layer 8	T = 68.00 °F
	layer 9	T = 68.00 °F
	layer 10	T = 68.00 °F
	layer 11	T = 68.00 °F
	layer 12	T = 68.00 °F
	layer 13	T = 68.00 °F
	layer 14	T = 68.00 °F
Ultimate Strength		
initial = 277 ksi	layer 1 (bottom)	f <sub>pu</sub> = 277 ksi
	layer 2	f <sub>pu</sub> = 277 ksi
	layer 3	f <sub>pu</sub> = 277 ksi
	layer 4	f <sub>pu</sub> = 277 ksi
	layer 5	f <sub>pu</sub> = 277 ksi
	layer 6	f <sub>pu</sub> = 277 ksi
	layer 7	f <sub>pu</sub> = 277 ksi
	layer 8	f <sub>pu</sub> = 277 ksi
	layer 9	f <sub>pu</sub> = 277 ksi
	layer 10	f <sub>pu</sub> = 277 ksi
	layer 11	f <sub>pu</sub> = 277 ksi
	layer 12	f <sub>pu</sub> = 277 ksi
	layer 13	f <sub>pu</sub> = 277 ksi
	layer 14	f <sub>pu</sub> = 277 ksi
Yield Strength		
initial = 250 ksi	layer 1 (bottom)	f <sub>py</sub> = 250 ksi
	layer 2	f <sub>py</sub> = 250 ksi
	layer 3	f <sub>py</sub> = 250 ksi
	layer 4	f <sub>py</sub> = 250 ksi
	layer 5	f <sub>py</sub> = 250 ksi
	layer 6	f <sub>py</sub> = 250 ksi
	layer 7	f <sub>py</sub> = 250 ksi
	layer 8	f <sub>py</sub> = 250 ksi
	layer 9	f <sub>py</sub> = 250 ksi
	layer 10	f <sub>py</sub> = 250 ksi
	layer 11	f <sub>py</sub> = 250 ksi
	layer 12	f <sub>py</sub> = 250 ksi
	layer 13	f <sub>py</sub> = 250 ksi
	layer 14	f <sub>py</sub> = 250 ksi
<b>Stress Limits:</b>		
before transfer ≤ 0.75f <sub>pu</sub> (initial = 207.6)	layer 1 (bottom)	f <sub>pi</sub> = 207.6 ksi
	layer 2	f <sub>pi</sub> = 207.6 ksi
	layer 3	f <sub>pi</sub> = 207.6 ksi
	layer 4	f <sub>pi</sub> = 207.6 ksi
	layer 5	f <sub>pi</sub> = 207.6 ksi
	layer 6	f <sub>pi</sub> = 207.6 ksi
	layer 7	f <sub>pi</sub> = 207.6 ksi
	layer 8	f <sub>pi</sub> = 207.6 ksi
	layer 9	f <sub>pi</sub> = 207.6 ksi
	layer 10	f <sub>pi</sub> = 207.6 ksi
	layer 11	f <sub>pi</sub> = 207.6 ksi
	layer 12	f <sub>pi</sub> = 207.6 ksi
	layer 13	f <sub>pi</sub> = 207.6 ksi
	layer 14	f <sub>pi</sub> = 207.6 ksi

at service limit state (after all losses)  $\leq 0.80f_{py}$  (initial = 199.7)

layer 1 (bottom)	$f_{pe} =$	199.7 ksi
layer 2	$f_{pe} =$	199.7 ksi
layer 3	$f_{pe} =$	199.7 ksi
layer 4	$f_{pe} =$	199.7 ksi
layer 5	$f_{pe} =$	199.7 ksi
layer 6	$f_{pe} =$	199.7 ksi
layer 7	$f_{pe} =$	199.7 ksi
layer 8	$f_{pe} =$	199.7 ksi
layer 9	$f_{pe} =$	199.7 ksi
layer 10	$f_{pe} =$	199.7 ksi
layer 11	$f_{pe} =$	199.7 ksi
layer 12	$f_{pe} =$	199.7 ksi
layer 13	$f_{pe} =$	199.7 ksi
layer 14	$f_{pe} =$	199.7 ksi

Modulus of Elasticity

initial = 25982 ksi

layer 1 (bottom)	E =	25982.0 ksi
layer 2	E =	25982.0 ksi
layer 3	E =	25982.0 ksi
layer 4	E =	25982.0 ksi
layer 5	E =	25982.0 ksi
layer 6	E =	25982.0 ksi
layer 7	E =	25982.0 ksi
layer 8	E =	25982.0 ksi
layer 9	E =	25982.0 ksi
layer 10	E =	25982.0 ksi
layer 11	E =	25982.0 ksi
layer 12	E =	25982.0 ksi
layer 13	E =	25982.0 ksi
layer 14	E =	25982.0 ksi

### MILD STEEL REINFORCING BARS

Yield Strength

Layer 1 (Bottom)	$f_y =$	60.0 ksi	68.00 °F
Layer 2 (Top)	$f_y =$	60.0 ksi	68.00 °F

Modulus of Elasticity

E =	29000.0 ksi
-----	-------------

Layer 1 (Bottom)

Area of steel at midspan (effective flange)	$A_{sm} =$	2.79 in <sup>2</sup>
Area of steel at endspan (effective flange)	$A_{se} =$	2.48 in <sup>2</sup>
Area of temperature and shrinkage steel (12" width)	$A_s =$	0.31 in <sup>2</sup>

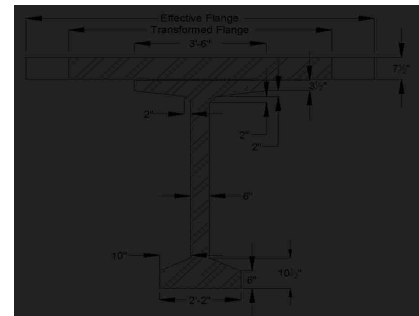
Layer 2 (Top)

Area of steel at midspan (effective flange)	$A_{sm} =$	12.6 in <sup>2</sup>
Area of steel at endspan (effective flange)	$A_{se} =$	12.4 in <sup>2</sup>
Area of temperature and shrinkage steel (12" width)	$A_s =$	0.2 in <sup>2</sup>

### Cross-sectional Properties

#### NON-COMPOSITE BEAM

Area of cross-section of beam	A =	767.0 in <sup>2</sup>
Overall depth of beam	H =	72.0 in
Moment of Inertia	I =	539,947 in <sup>4</sup>
Distance from centroid to extreme <b>bottom</b> fiber	$y_b =$	36.6 in
Distance from centroid to extreme <b>top</b> fiber	$y_t =$	35.4 in
Section modulus for the extreme <b>bottom</b> fiber	$S_b =$	14915.0 in <sup>3</sup>
Section modulus for the extreme <b>top</b> fiber	$S_t =$	15421.0 in <sup>3</sup>
Weight	$W_t =$	799.0 plf
Modulus of Elasticity = $33000 \cdot (W_c^{1.5}) \cdot (\sqrt{f'_c})$		
cast-in-place concrete deck	$E_{cs} =$	3834 ksi
precast beam at release	$E_{ci} =$	4496 ksi
precast beam at service loads	$E_c =$	5072 ksi





### COMPOSITE BEAM

Effective Flange Width	$b_f =$	111.0 in	*min of three criteria
Modular Ratio = $E_{cs}/E_c$	$n =$	0.7559	
Transformed flange width	$=$	83.9 in	
Transformed flange area	$=$	629.3 in <sup>2</sup>	
Transformed haunch width	$=$	31.7 in	
Transformed haunch area	$=$	15.9 in <sup>2</sup>	

	Transformed Area	$y_b$	$Ay_b$	$A(y_{bc}-y_b)^2$	I	$I + A(y_{bc}-y_b)^2$
Beam	767.0 in <sup>2</sup>	36.60 in	28,072.2 in <sup>3</sup>	250,443 in <sup>4</sup>	539,947 in <sup>4</sup>	790,390 in <sup>4</sup>
Haunch	15.9 in <sup>2</sup>	72.25 in	1,146.9 in <sup>3</sup>	4,906 in <sup>4</sup>	0.33 in <sup>4</sup>	4,906 in <sup>4</sup>
Deck	629.3 in <sup>2</sup>	76.25 in	47,985.0 in <sup>3</sup>	293,069 in <sup>4</sup>	2,950 in <sup>4</sup>	296,019 in <sup>4</sup>
Total	1412.2 in <sup>2</sup>		77,204.1 in <sup>3</sup>			1,091,315 in <sup>4</sup>

Total area of Composite Section	$A_c =$	1412 in <sup>2</sup>
Overall Depth of the Composite Section	$h_c =$	80 in
Moment of Inertia	$I_c =$	1,091,315 in <sup>4</sup>
Distance from centroid to extreme <u>bottom</u> fiber of beam	$y_{bc} =$	54.67 in
Distance from centroid to extreme <u>top</u> fiber of beam	$y_{tg} =$	17.33 in
Distance from centroid to extreme <u>top</u> fiber of slab	$y_{tc} =$	25.33 in
Section modulus for the extreme <u>bottom</u> fiber of beam	$S_{bc} =$	19,961.9 in <sup>3</sup>
Section modulus for the extreme <u>top</u> fiber of beam	$S_{tg} =$	62,972.4 in <sup>3</sup>
Section modulus for the extreme <u>top</u> fiber slab	$S_{tc} =$	56,994.5 in <sup>3</sup>

### DECK (as 12" beam)

Reinforcing per 12"		at midspan	at beams
Layer 1 (Bottom)	$A_s =$	0.3 in <sup>2</sup>	0.3 in <sup>2</sup>
Layer 2 (Top)	$A_s =$	0.2 in <sup>2</sup>	0.2 in <sup>2</sup>

Modulus of Elasticity = $33000 \cdot (W_c^{1.5}) \cdot (\sqrt{f'_c})$ cast-in-place concrete deck	$E_{cs} =$	3834 ksi
--	------------	----------

Moment of Inertia	$I_g =$	512 in <sup>4</sup>
Distance from centroid to extreme <u>bottom</u> fiber of deck	$y_b =$	4.00 in
Distance from centroid to extreme <u>top</u> fiber of deck	$y_t =$	4.00 in
Modulus of Rupture	$f_r =$	474.3 psi
Cracking Moment	$M_{CR} =$	5.1 ft-kips
Max negative moment at loading stage	$M_a =$	16.9 ft-kips
Cracking Moment of Inertia	$I_{cr} =$	87 in <sup>4</sup>
Effective Moment of Inertia	$I_e =$	99 in <sup>4</sup>
Effective Moment of Inertia for Continuous Beam	$I_e =$	96 in <sup>4</sup>

### Shear Forces and Bending Moments

#### DEAD LOADS

Beam self-weight	$w_{beam} =$	0.799 k/f
8 in. deck weight	$w_{deck} =$	1.200 k/f
1/2 in. haunch weight	$w_{haunch} =$	0.022 k/f

LRFD Specifications: Art. 4.6.2.2.1

Width of Deck Constant		OK
Number of beams is not less than four $N_b =$	4	OK
Roadway part of the overhang, $d_o \leq 3.0$ ft, $d_o =$	1.5	OK
Curvature in plans is less than $4^\circ =$	0	OK
Cross-section of the bridge is consistent with one of the cross sections given by LRFD specs		OK

Barrier and wearing surface loads are equally distributed among the 4 beams

Barrier Wt	$W_t =$	0.150 k/f
Dead load of future wearing surface	$DW =$	0.263 k/f

### LIVE LOADS

Fire truck live load front load (Point A)	$P_{live} =$	48.0 kips
Fire truck live load back load (Point B)	$P_{live} =$	22.0 kips
distance between two loads		19.2 ft
distance from nearest edge to point A	$x_a =$	59.0 ft
distance from nearest edge to point B	$x_b =$	39.8 ft
LRFD Specifications: Art. 4.6.2.2.1		
Width of Deck Constant		OK
Number of beams is not less than four $N_b =$	4	OK
Beams are parallel and approximately of the same stiffness		OK
Roadway part of the overhang, $d_o \leq 3.0$ ft, $d_e =$	1.5	OK
Curvature in plans is less than $4^\circ =$	0	OK

Barrier and wearing surface loads are equally distributed among the 4 beams

Bridge Type-- "k" (LRFD Table 4.6.2.2.1-1)

Number of design lanes = $w/12$	=	3 lanes
---------------------------------	---	---------

### Distribution Factor for Bending Moment:

Beams spacing	$S =$	12.0 ft
Depth of concrete slab	$t_s =$	7.5 in
Beam Span	$L =$	120.0 ft
Number of Beams	$N_b =$	4
Modular ratio between beam & deck materials	$n =$	1.3229
Longitudinal stiffness parameter	$K_g =$	2,309,429.79 in <sup>4</sup>

at center span:

$$DFM = 0.75 + \left(\frac{S}{9.5}\right)^{0.6} + \left(\frac{S}{L}\right)^{0.2} + \left(\frac{K_g}{12 * L * t_s^3}\right)^{0.1}$$

DFM = 0.905 lanes/beam

0.905 Controls

one design lane loaded:

$$DFM = 0.75 + \left(\frac{S}{14}\right)^{0.4} * \left(\frac{S}{L}\right)^{0.3} * \left(\frac{K_g}{12 * L * t_s^3}\right)^{0.1}$$

DFM = 0.614 lanes/beam

### Distribution Factor for Shear Force

both end spans and center span:

$$DFV = 0.2 + \left(\frac{S}{12}\right) - \left(\frac{S}{35}\right)^2$$

DFV = 1.082 lanes/beam

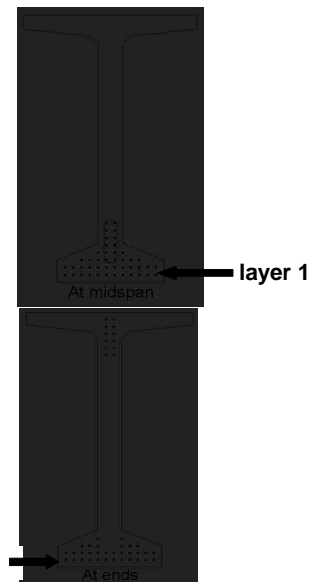
1.082 Controls

one design lane loaded:

$$DFV = 0.36 + \left(\frac{S}{25}\right)$$

DFV = 0.840 lanes/beam

from bottom	At Midspan		At Ends	
	No. of	Distance from Bottom	No. of	Distance from Bottom
layer 1	12	2	12	2
layer 2	12	4	12	4
layer 3	8	6	6	6
layer 4	4	8	2	8
layer 5	2	10	-	-
layer 6	2	12	-	-
layer 7	2	14	-	-
layer 8	2	16	-	-
layer 9	-	-	2	60
layer 10	-	-	2	62
layer 11	-	-	2	64
layer 12	-	-	2	66
layer 13	-	-	2	68
layer 14	-	-	2	70
<b>Harped Strand Group (included in above totals)</b>				
layer 3	2	6		
layer 4	2	8		
layer 5	2	10		
layer 6	2	12		
layer 7	2	14		
layer 8	2	16		



distance from the center of gravity of strands to the bottom fiber of the beam = 7% of the beam depth  
strand eccentricity at midspan =  $(y_b - y_{bs})$

$y_{bs} =$	5.82 in
$e_c =$	30.78 in

### Prestress Losses

#### ELASTIC SHORTENING

assumed loss	=	9.00%	
Force per strand at transfer			
layer 1	=	28.9 kips	
layer 2	=	28.9 kips	
layer 3	=	28.9 kips	
layer 4	=	28.9 kips	
layer 5	=	28.9 kips	
layer 6	=	28.9 kips	
layer 7	=	28.9 kips	
layer 8	=	28.9 kips	
layer 9	=	28.9 kips	
layer 10	=	28.9 kips	
layer 11	=	28.9 kips	
layer 12	=	28.9 kips	
layer 13	=	28.9 kips	
layer 14	=	28.9 kips	
		<b>at midspan</b>	<b>at endspan</b>
Total prestressing force at release	$P_i =$	1271.6 kips	1271.6 kips
Sum of concrete stresses at the center of gravity of prestressing tendons due to prestressing force at transfer and the self-weight of the member at sections of maximum moment	$f_{cgp} =$	2.938 ksi	2.938 ksi
Loss due to shortening			
		<b>at midspan</b>	<b>at endspan</b>
layer 1	$\Delta f_{pES} =$	17.0 ksi	17.0 ksi
layer 2	$\Delta f_{pES} =$	17.0 ksi	17.0 ksi
layer 3	$\Delta f_{pES} =$	17.0 ksi	17.0 ksi
layer 4	$\Delta f_{pES} =$	17.0 ksi	17.0 ksi
layer 5	$\Delta f_{pES} =$	17.0 ksi	
layer 6	$\Delta f_{pES} =$	17.0 ksi	
layer 7	$\Delta f_{pES} =$	17.0 ksi	
layer 8	$\Delta f_{pES} =$	17.0 ksi	
layer 9	$\Delta f_{pES} =$		17.0 ksi
layer 10	$\Delta f_{pES} =$		17.0 ksi
layer 11	$\Delta f_{pES} =$		17.0 ksi
layer 12	$\Delta f_{pES} =$		17.0 ksi
layer 13	$\Delta f_{pES} =$		17.0 ksi
layer 14	$\Delta f_{pES} =$		17.0 ksi

#### SHRINKAGE

Shrinkage =  $(17 - 0.15 \times \text{Relative Humidity})$   $\Delta f_{pSR} =$  6.5 ksi ← assume relative humidity = 70%

#### CREEP OF CONCRETE

Change of stresses at center of gravity of prestressing due to permanent loads except the loads acting at time of applying prestressing force, calculated at the same section as $f_{cgp}$	$\Delta f_{cdp} =$	1.563 ksi	
		<b>at midspan</b>	<b>at endspan</b>
loss due to creep	$\Delta f_{pCR} =$	24.3 ksi	24.3 ksi

**RELAXATION OF PRESTRESSING STRANDS**

loss due to relaxation after transfer		at midspan	at endspan
layer 1	$\Delta f_{pR2} =$	2.1 ksi	2.1 ksi
layer 2	$\Delta f_{pR2} =$	2.1 ksi	2.1 ksi
layer 3	$\Delta f_{pR2} =$	2.1 ksi	2.1 ksi
layer 4	$\Delta f_{pR2} =$	2.1 ksi	2.1 ksi
layer 5	$\Delta f_{pR2} =$	2.1 ksi	
layer 6	$\Delta f_{pR2} =$	2.1 ksi	
layer 7	$\Delta f_{pR2} =$	2.1 ksi	
layer 8	$\Delta f_{pR2} =$	2.1 ksi	
layer 9	$\Delta f_{pR2} =$		2.1 ksi
layer 10	$\Delta f_{pR2} =$		2.1 ksi
layer 11	$\Delta f_{pR2} =$		2.1 ksi
layer 12	$\Delta f_{pR2} =$		2.1 ksi
layer 13	$\Delta f_{pR2} =$		2.1 ksi
layer 14	$\Delta f_{pR2} =$		2.1 ksi

**TOTAL LOSSES AT TRANSFER**

total loss  $\Delta f_{pES} = \Delta f_{pi}$

stress in tendons after transfer  $f_{pt} = f_{pi} - \Delta f_{pi}$

		at midspan	at endspan
layer 1	$f_{pt} =$	190.6 ksi	190.6 ksi
layer 2	$f_{pt} =$	190.6 ksi	190.6 ksi
layer 3	$f_{pt} =$	190.6 ksi	190.6 ksi
layer 4	$f_{pt} =$	190.6 ksi	190.6 ksi
layer 5	$f_{pt} =$	190.6 ksi	
layer 6	$f_{pt} =$	190.6 ksi	
layer 7	$f_{pt} =$	190.6 ksi	
layer 8	$f_{pt} =$	190.6 ksi	
layer 9	$f_{pt} =$		190.6 ksi
layer 10	$f_{pt} =$		190.6 ksi
layer 11	$f_{pt} =$		190.6 ksi
layer 12	$f_{pt} =$		190.6 ksi
layer 13	$f_{pt} =$		190.6 ksi
layer 14	$f_{pt} =$		190.6 ksi

force per strand =  $f_{pt} \cdot \text{strand area}$

		at midspan	at endspan
layer 1	=	29.2 kips	29.2 kips
layer 2	=	29.2 kips	29.2 kips
layer 3	=	29.2 kips	29.2 kips
layer 4	=	29.2 kips	29.2 kips
layer 5	=	29.2 kips	
layer 6	=	29.2 kips	
layer 7	=	29.2 kips	
layer 8	=	29.2 kips	
layer 9	=		29.2 kips
layer 10	=		29.2 kips
layer 11	=		29.2 kips
layer 12	=		29.2 kips
layer 13	=		29.2 kips
layer 14	=		29.2 kips
Total prestressing force after transfer	$P_i =$	1284.8 kips	1284.8 kips

Initial loss =  $(\Delta f_{pi}) / (f_{pi})$

		at midspan	at endspan
layer 1	% =	8.2%	8.2%
layer 2	% =	8.2%	8.2%
layer 3	% =	8.2%	8.2%
layer 4	% =	8.2%	8.2%
layer 5	% =	8.2%	
layer 6	% =	8.2%	
layer 7	% =	8.2%	
layer 8	% =	8.2%	
layer 9	% =		8.2%
layer 10	% =		8.2%
layer 11	% =		8.2%
layer 12	% =		8.2%
layer 13	% =		8.2%
layer 14	% =		8.2%

OK  
OK  
OK  
OK  
OK  
OK  
OK  
OK  
OK  
OK  
OK  
OK  
OK  
OK  
OK

**TOTAL LOSSES AT SERVICE LOADS**

Total Losses		at midspan	at endspan
layer 1	$\Delta f_{pT} =$	49.9 ksi	49.9 ksi
layer 2	$\Delta f_{pT} =$	49.9 ksi	49.9 ksi
layer 3	$\Delta f_{pT} =$	49.9 ksi	49.9 ksi
layer 4	$\Delta f_{pT} =$	49.9 ksi	49.9 ksi
layer 5	$\Delta f_{pT} =$	49.9 ksi	
layer 6	$\Delta f_{pT} =$	49.9 ksi	
layer 7	$\Delta f_{pT} =$	49.9 ksi	
layer 8	$\Delta f_{pT} =$	49.9 ksi	
layer 9	$\Delta f_{pT} =$		49.9 ksi
layer 10	$\Delta f_{pT} =$		49.9 ksi
layer 11	$\Delta f_{pT} =$		49.9 ksi
layer 12	$\Delta f_{pT} =$		49.9 ksi
layer 13	$\Delta f_{pT} =$		49.9 ksi
layer 14	$\Delta f_{pT} =$		49.9 ksi

Stress in tendon after all losses =  $f_{pr} - \Delta f_{pt}$

		at midspan	at endspan
layer 1	$f_{pe} =$	157.7 ksi	157.7 ksi
layer 2	$f_{pe} =$	157.7 ksi	157.7 ksi
layer 3	$f_{pe} =$	157.7 ksi	157.7 ksi
layer 4	$f_{pe} =$	157.7 ksi	157.7 ksi
layer 5	$f_{pe} =$	157.7 ksi	
layer 6	$f_{pe} =$	157.7 ksi	
layer 7	$f_{pe} =$	157.7 ksi	
layer 8	$f_{pe} =$	157.7 ksi	
layer 9	$f_{pe} =$		157.7 ksi
layer 10	$f_{pe} =$		157.7 ksi
layer 11	$f_{pe} =$		157.7 ksi
layer 12	$f_{pe} =$		157.7 ksi
layer 13	$f_{pe} =$		157.7 ksi
layer 14	$f_{pe} =$		157.7 ksi

check prestressing stress limit at service limit state:  $f_{pe} \leq 0.8 * f_{py}$

layer 1	=	199.7 ksi
layer 2	=	199.7 ksi
layer 3	=	199.7 ksi
layer 4	=	199.7 ksi
layer 5	=	199.7 ksi
layer 6	=	199.7 ksi
layer 7	=	199.7 ksi
layer 8	=	199.7 ksi
layer 9	=	199.7 ksi
layer 10	=	199.7 ksi
layer 11	=	199.7 ksi
layer 12	=	199.7 ksi
layer 13	=	199.7 ksi
layer 14	=	199.7 ksi

OK  
OK  
OK  
OK  
OK  
OK  
OK  
OK  
OK  
OK  
OK  
OK  
OK  
OK

force per strand =  $f_{pe} * \text{strand area}$

		at midspan	at endspan
layer 1	=	24.1 kips	24.1 kips
layer 2	=	24.1 kips	24.1 kips
layer 3	=	24.1 kips	24.1 kips
layer 4	=	24.1 kips	24.1 kips
layer 5	=	24.1 kips	
layer 6	=	24.1 kips	
layer 7	=	24.1 kips	
layer 8	=	24.1 kips	
layer 9	=		24.1 kips
layer 10	=		24.1 kips
layer 11	=		24.1 kips
layer 12	=		24.1 kips
layer 13	=		24.1 kips
layer 14	=		24.1 kips

		at midspan	at endspan
Total prestressing force after all losses	$P_{pe} =$	1061.6 kips	1061.6 kips
Final losses, % = $(\Delta f_{pT})/(f_{pi})$			
layer 1	% =	24.0%	24.0%
layer 2	% =	24.0%	24.0%
layer 3	% =	24.0%	24.0%
layer 4	% =	24.0%	24.0%
layer 5	% =	24.0%	
layer 6	% =	24.0%	
layer 7	% =	24.0%	
layer 8	% =	24.0%	
layer 9	% =		24.0%
layer 10	% =		24.0%
layer 11	% =		24.0%
layer 12	% =		24.0%
layer 13	% =		24.0%
layer 14	% =		24.0%
Average final losses, %	% =	24.0%	24.0%

### Stresses at Transfer

#### STRESS LIMITS FOR CONCRETE

Compression = $0.6f_{ci}$	$f_{ci} =$	3.300 ksi
Tension		
without bonded reinforcement = $-0.0948\sqrt{f_{ci}} \leq -0.2$	=	-0.200 ksi
with bonded auxiliary reinforcement = $-0.22\sqrt{f_{ci}}$	=	-0.016 ksi

#### STRESSES AT TRANSFER LENGTH SECTION

Transfer Length = $60 \times (\text{strand diameter})$	=	2.5 ft	} Calcs for eccentricity (see 9.6.7.2)
Bending moment at transfer length	$M_g =$	116.4 ft-kips	
center of 12 strands to top fiber of beam at the end	=	7.00 in	
center of 12 strands to bottom fiber of beam at the harp point	=	11.00 in	
center of 12 strands and top fiber of beam at transfer length	=	10.78 in	
center of gravity of 32 strands and bottom fiber of beam	=	3.88 in	
center of gravity of all strands and the bottom fiber of beam at transfer length	=	19.51 in	
center of gravity of all strands and the bottom fiber of beam at the end	=	20.55 in	
Eccentricity of the strand group at transfer length:	$e_{11} =$	17.09 in	}
Eccentricity at end of beam:	$e =$	16.05 in	

$$f_t = \frac{P_i}{A} - \frac{P_i e}{S_t} + \frac{M_g}{S_t}$$

$$f_b = \frac{P_i}{A} + \frac{P_i e}{S_b} - \frac{M_g}{S_b}$$

		at midspan	at endspan
Top stress at top fiber of beam	$f_t =$	0.342 ksi	0.342 ksi
Bottom stress at bottom fiber of the beam	$f_b =$	3.021 ksi	3.021 ksi

OK

OK

#### STRESSES AT HARP POINT

Bending moment due to beam weight at 0.3L	$M_g =$	1188.0 ft-kips	
Top stress at top fiber of beam	$f_t =$	0.035 ksi	0.035 ksi
Bottom stress at bottom fiber of the beam	$f_b =$	3.300 ksi	3.300 ksi

OK

OK

#### STRESSES AT MIDSPAN

Bending moment due to beam weight at 0.5L	$M_g =$	1414.3 ft-kips	
Top stress at top fiber of beam	$f_t =$	0.220 ksi	0.211 ksi
Bottom stress at bottom fiber of the beam	$f_b =$	3.144 ksi	3.189 ksi

OK

OK

### HOLD-DOWN FORCES

assume stress in strand before losses =  $0.8f_u$

layer 1	=	221.4 ksi
layer 2	=	221.4 ksi
layer 3	=	221.4 ksi
layer 4	=	221.4 ksi
layer 5	=	221.4 ksi
layer 6	=	221.4 ksi
layer 7	=	221.4 ksi
layer 8	=	221.4 ksi
layer 9	=	221.4 ksi
layer 10	=	221.4 ksi
layer 11	=	221.4 ksi
layer 12	=	221.4 ksi
layer 13	=	221.4 ksi
layer 14	=	221.4 ksi

prestress force per strand before any losses:

layer 1	=	33.9 kips
layer 2	=	33.9 kips
layer 3	=	33.9 kips
layer 4	=	33.9 kips
layer 5	=	33.9 kips
layer 6	=	33.9 kips
layer 7	=	33.9 kips
layer 8	=	33.9 kips
layer 9	=	33.9 kips
layer 10	=	33.9 kips
layer 11	=	33.9 kips
layer 12	=	33.9 kips
layer 13	=	33.9 kips
layer 14	=	33.9 kips
Harp Angle	$\psi$ =	7.2 °

Hold-down force/strand

layer 1	=	4.4 kips/strand
layer 2	=	4.4 kips/strand
layer 3	=	4.4 kips/strand
layer 4	=	4.4 kips/strand
layer 5	=	4.4 kips/strand
layer 6	=	4.4 kips/strand
layer 7	=	4.4 kips/strand
layer 8	=	4.4 kips/strand
layer 9	=	4.4 kips/strand
layer 10	=	4.4 kips/strand
layer 11	=	4.4 kips/strand
layer 12	=	4.4 kips/strand
layer 13	=	4.4 kips/strand
layer 14	=	4.4 kips/strand
Total hold-down force	=	53.39 kips

### Stresses at Service Loads

#### STRESS LIMITS FOR CONCRETE

##### Compression:

Due to permanent loads for load combination Service I

for the precast beam	=	3.150 ksi
for deck	=	1.800 ksi

Due to permanent and transient loads for load combination Service I

for the precast beam	=	4.200 ksi
for deck	=	2.400 ksi

##### Tension:

Load Combination Service III

for the precast beam	=	-0.016 ksi
----------------------	---	------------

STRESSES AT MIDSPAN			
Compression stresses at top fiber of beam	at midspan	at endspan	
$f_x = \frac{P_{ps}}{A} - \frac{P_{ps}e^2}{S_x} + \frac{(M_D + M_L)}{S_x} + \frac{(M_{ws} + M_b)}{S_{xg}}$			
Due to permanent loads	$f_{ig} =$	2.041 ksi	2.041 ksi
$f_{ig} = \frac{P_{ps}}{A} - \frac{P_{ps}e^2}{S_x} + \frac{(M_D + M_L)}{S_x} + \frac{(M_{ws} + M_b)}{S_{xg}} + \frac{(M_{LL+I})}{S_{xg}}$			
Due to permanent loads and transient loads	$f_{ig} =$	2.444 ksi	2.444 ksi
Compression stresses at top fiber of deck	at midspan	at endspan	
$f_{tc} = \frac{(M_{ws} + M_b)}{S_{xc}}$			
Due to permanent loads	$f_{tc} =$	0.042 ksi	0.042 ksi
$f_{tc} = \frac{(M_{ws} + M_b + M_{LL+I})}{S_{xc}}$			
Due to permanent loads and transient loads	$f_{tc} =$	0.488 ksi	0.488 ksi
Tension stresses at top fiber of deck	at midspan	at endspan	
$f_{tr} = \frac{P_{ps}}{A} + \frac{P_{ps}e^2}{S_b} - \frac{(M_D + M_L)}{S_b} - \frac{(M_{ws} + M_b + 0.9M_{LL+I})}{S_{bc}}$			
Load Combination Service III	$f_b =$	-0.393 ksi	-0.393 ksi

OK

OK

OK

OK

OK

**Strength Limit State**

POSITIVE MOMENT SECTION		
$M_u = 1.25DC + 1.5DW + 1.75(LL+IM)$	$M_u =$	8381.5 ft-kips
effective length factor for compression members		
layer 1	k =	0.28
layer 2	k =	0.28
layer 3	k =	0.28
layer 4	k =	0.28
layer 5	k =	0.28
layer 6	k =	0.28
layer 7	k =	0.28
layer 8	k =	0.28
layer 9	k =	0.28
layer 10	k =	0.28
layer 11	k =	0.28
layer 12	k =	0.28
layer 13	k =	0.28
layer 14	k =	0.28
	c =	5.7 ft-kips
average stress in prestressing steel		
layer 1	$f_{ps} =$	270.9 ksi
layer 2	$f_{ps} =$	270.9 ksi
layer 3	$f_{ps} =$	270.9 ksi
layer 4	$f_{ps} =$	270.9 ksi
layer 5	$f_{ps} =$	270.9 ksi
layer 6	$f_{ps} =$	270.9 ksi
layer 7	$f_{ps} =$	270.9 ksi
layer 8	$f_{ps} =$	270.9 ksi
layer 9	$f_{ps} =$	270.9 ksi
layer 10	$f_{ps} =$	270.9 ksi
layer 11	$f_{ps} =$	270.9 ksi
layer 12	$f_{ps} =$	270.9 ksi
layer 13	$f_{ps} =$	270.9 ksi
layer 14	$f_{ps} =$	270.9 ksi
nominal flexure resistance		
$M_r = \Phi M_n, \Phi = 1.00$	$\Phi M_n =$	10906.2 ft-kips
	a =	4.85 in
	$\Phi M_n =$	10906.2 ft-kips
		OK
NEGATIVE MOMENT SECTION		
$M_u = 1.25DC + 1.5DW + 1.75(LL+IM)$	$M_u =$	-4837.2 ft-kips
	a =	0.20 in
	$\Phi M_n =$	5273.8 ft-kips
		OK



### Shear Design

CRITICAL SECTION AT 0.59			
$V_u = 1.25DC + 1.5DW + 1.75(LL+IM)$	$V_u =$	405.0 kips	
$M_u = 1.25DC + 1.5DW + 1.75(LL+IM)$	$M_u =$	-2684.4 ft-kips	
or			
$V_u = 1.25DC + 1.5DW + 1.75(LL+IM)$	$V_u =$	364.8 kips	
$M_u = 1.25DC + 1.5DW + 1.75(LL+IM)$	$M_u =$	-2877.0 ft-kips	
max shear	$V_u =$	405.0 kips	
max moment	$M_u =$	2877.0 ft-kips	
Shear depth	$d_v =$	73.19 in	
Applied factored normal force at the section	$N_u =$	0	
Angle of diagonal compressive stresses	$\theta =$	36.00 °	

### STRAIN IN FLEXURAL TENSION REINFORCEMENT

$$\epsilon_s = \frac{M_u + 0.5N_u + 0.5V_u \cot \theta - A_{ps} f_{ps}}{E_s A_s + E_s A_{ps}} \leq 0.002$$

		at midspan	at endspan
resultant compressive stress at centroid	$f_{pc} =$	0.994 ksi	0.994 ksi

effective stress in prestressing strand after all losses

layer 1	$f_{po} =$	162.8 ksi	162.8 ksi
layer 2	$f_{po} =$	162.8 ksi	162.8 ksi
layer 3	$f_{po} =$	162.8 ksi	162.8 ksi
layer 4	$f_{po} =$	162.8 ksi	162.8 ksi
layer 5	$f_{po} =$	162.8 ksi	
layer 6	$f_{po} =$	162.8 ksi	
layer 7	$f_{po} =$	162.8 ksi	
layer 8	$f_{po} =$	162.8 ksi	
layer 9	$f_{po} =$		162.8 ksi
layer 10	$f_{po} =$		162.8 ksi
layer 11	$f_{po} =$		162.8 ksi
layer 12	$f_{po} =$		162.8 ksi
layer 13	$f_{po} =$		162.8 ksi
layer 14	$f_{po} =$		162.8 ksi

strain in flexural tension

		at midspan	at endspan
layer 1	$\epsilon_x =$	0.002000	0.002000
layer 2	$\epsilon_x =$	0.002000	0.002000
layer 3	$\epsilon_x =$	0.002000	0.002000
layer 4	$\epsilon_x =$	0.002000	0.002000
layer 5	$\epsilon_x =$	0.002000	
layer 6	$\epsilon_x =$	0.002000	
layer 7	$\epsilon_x =$	0.002000	
layer 8	$\epsilon_x =$	0.002000	
layer 9	$\epsilon_x =$		0.002000
layer 10	$\epsilon_x =$		0.002000
layer 11	$\epsilon_x =$		0.002000
layer 12	$\epsilon_x =$		0.002000
layer 13	$\epsilon_x =$		0.002000
layer 14	$\epsilon_x =$		0.002000

### Deflection and Camber

		at midspan	at endspan
Deflection due to Prestressing Force at Transfer	$\Delta_p =$	3.97 in	3.97 in
Deflection due to Beam Self-Weight at Transfer	$\Delta_g =$	-1.49 in	
Deflection due to Beam Self-Weight at Erection	$\Delta_g =$	-1.44 in	
Deflection due to Haunch and Deck	$\Delta_g =$	-1.95 in	

Deflection due to total self weight

$\Delta_{sw} =$	0.59 in
-----------------	---------

Total Deflection at transfer

$\Delta =$	2.48 in	2.48 in
------------	---------	---------

Total Deflection at erection

$\Delta =$	4.49 in	4.49 in
------------	---------	---------

### Deck Deflection (assuming 12" beam)

Deflection due to Deck Self-Weight  
Live load deflection limit = span/800  
Deflection due to live load and impact

$\Delta_g =$	-0.9835 in
$=$	0.18 in
$\Delta_l =$	-0.13 in

OK

**Location: Fire above Deck Between Girders**  
**Beam Design: 1/2" Strand**  
**Fire Exposure Status: 1/2 Hour**

(PCI Bridge Design Manual Section 9.6)



**Material Properties**

CAST-IN-PLACE SLAB		
Actual Thickness	$t_{as} =$	8.0 in
Wearing Surface	$=$	0.5 in
Structural thickness = Actual - Wearing Surface	$t_s =$	7.5 in
Compressive Strength	$f'_c =$	3.74 ksi
Unit Weight	$w_c =$	150.0 pcf
Stress factor of compression block	$\beta_1 =$	0.85

BEAMS: AASHTO-PCI, BT-72 BULB-TEE		
Strength at release	$f'_{ci} =$	5.5 ksi
Strength at 28 days	$f'_c =$	7 ksi
Unit Weight	$w_c =$	150.0 pcf
Overall Beam Length:		
@ end spans	$L =$	110 ft
@ center span	$L =$	119 ft
Design Spans:		
Non-composite beam @ end spans	$L =$	109 ft
Non-composite beam @ center span	$L =$	118 ft
Composite beam @ end spans	$L =$	110 ft
Composite beam @ center span	$L =$	120 ft
Beam Spacing	$S =$	12 ft



**PRESTRESSING STRANDS**

Diameter of single strand		d =	0.5 in
Area of single strand		A =	0.153 in <sup>2</sup>
Temperature of Layer			
	layer 1 (bottom)	T =	68.00 °F
	layer 2	T =	68.00 °F
	layer 3	T =	68.00 °F
	layer 4	T =	68.00 °F
	layer 5	T =	68.00 °F
	layer 6	T =	68.00 °F
	layer 7	T =	68.00 °F
	layer 8	T =	68.00 °F
	layer 9	T =	68.00 °F
	layer 10	T =	68.00 °F
	layer 11	T =	68.00 °F
	layer 12	T =	68.00 °F
	layer 13	T =	68.00 °F
	layer 14	T =	68.00 °F
Ultimate Strength			
initial =	277 ksi		
	layer 1 (bottom)	f <sub>pu</sub> =	277 ksi
	layer 2	f <sub>pu</sub> =	277 ksi
	layer 3	f <sub>pu</sub> =	277 ksi
	layer 4	f <sub>pu</sub> =	277 ksi
	layer 5	f <sub>pu</sub> =	277 ksi
	layer 6	f <sub>pu</sub> =	277 ksi
	layer 7	f <sub>pu</sub> =	277 ksi
	layer 8	f <sub>pu</sub> =	277 ksi
	layer 9	f <sub>pu</sub> =	277 ksi
	layer 10	f <sub>pu</sub> =	277 ksi
	layer 11	f <sub>pu</sub> =	277 ksi
	layer 12	f <sub>pu</sub> =	277 ksi
	layer 13	f <sub>pu</sub> =	277 ksi
	layer 14	f <sub>pu</sub> =	277 ksi
Yield Strength			
initial =	250 ksi		
	layer 1 (bottom)	f <sub>py</sub> =	250 ksi
	layer 2	f <sub>py</sub> =	250 ksi
	layer 3	f <sub>py</sub> =	250 ksi
	layer 4	f <sub>py</sub> =	250 ksi
	layer 5	f <sub>py</sub> =	250 ksi
	layer 6	f <sub>py</sub> =	250 ksi
	layer 7	f <sub>py</sub> =	250 ksi
	layer 8	f <sub>py</sub> =	250 ksi
	layer 9	f <sub>py</sub> =	250 ksi
	layer 10	f <sub>py</sub> =	250 ksi
	layer 11	f <sub>py</sub> =	250 ksi
	layer 12	f <sub>py</sub> =	250 ksi
	layer 13	f <sub>py</sub> =	250 ksi
	layer 14	f <sub>py</sub> =	250 ksi
<b>Stress Limits:</b>			
before transfer	≤ 0.75f <sub>pu</sub> (initial = 207.6)		
	layer 1 (bottom)	f <sub>pi</sub> =	207.6 ksi
	layer 2	f <sub>pi</sub> =	207.6 ksi
	layer 3	f <sub>pi</sub> =	207.6 ksi
	layer 4	f <sub>pi</sub> =	207.6 ksi
	layer 5	f <sub>pi</sub> =	207.6 ksi
	layer 6	f <sub>pi</sub> =	207.6 ksi
	layer 7	f <sub>pi</sub> =	207.6 ksi
	layer 8	f <sub>pi</sub> =	207.6 ksi
	layer 9	f <sub>pi</sub> =	207.6 ksi
	layer 10	f <sub>pi</sub> =	207.6 ksi
	layer 11	f <sub>pi</sub> =	207.6 ksi
	layer 12	f <sub>pi</sub> =	207.6 ksi
	layer 13	f <sub>pi</sub> =	207.6 ksi
	layer 14	f <sub>pi</sub> =	207.6 ksi

at service limit state (after all losses)  $\leq 0.80f_{py}$  (initial = 199.7)

layer 1 (bottom)	$f_{pe} =$	199.7 ksi
layer 2	$f_{pe} =$	199.7 ksi
layer 3	$f_{pe} =$	199.7 ksi
layer 4	$f_{pe} =$	199.7 ksi
layer 5	$f_{pe} =$	199.7 ksi
layer 6	$f_{pe} =$	199.7 ksi
layer 7	$f_{pe} =$	199.7 ksi
layer 8	$f_{pe} =$	199.7 ksi
layer 9	$f_{pe} =$	199.7 ksi
layer 10	$f_{pe} =$	199.7 ksi
layer 11	$f_{pe} =$	199.7 ksi
layer 12	$f_{pe} =$	199.7 ksi
layer 13	$f_{pe} =$	199.7 ksi
layer 14	$f_{pe} =$	199.7 ksi

Modulus of Elasticity

initial = 25982 ksi

layer 1 (bottom)	E =	25982.0 ksi
layer 2	E =	25982.0 ksi
layer 3	E =	25982.0 ksi
layer 4	E =	25982.0 ksi
layer 5	E =	25982.0 ksi
layer 6	E =	25982.0 ksi
layer 7	E =	25982.0 ksi
layer 8	E =	25982.0 ksi
layer 9	E =	25982.0 ksi
layer 10	E =	25982.0 ksi
layer 11	E =	25982.0 ksi
layer 12	E =	25982.0 ksi
layer 13	E =	25982.0 ksi
layer 14	E =	25982.0 ksi

#### MILD STEEL REINFORCING BARS AT ENDSpan

Yield Strength

Layer 1 (Bottom)	$f_y =$	60.0 ksi	68.00 °F
Layer 2 (Top)	$f_y =$	58.2 ksi	550.00 °F

Modulus of Elasticity

E =	29000.0 ksi
-----	-------------

Layer 1 (Bottom)

Area of steel at midspan (effective flange)	$A_{sm} =$	2.79 in <sup>2</sup>
Area of steel at endspan (effective flange)	$A_{se} =$	2.48 in <sup>2</sup>
Area of temperature and shrinkage steel (12" width)	$A_s =$	0.31 in <sup>2</sup>

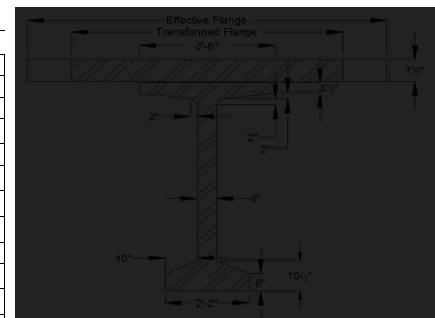
Layer 2 (Top)

Area of steel at midspan (effective flange)	$A_{sm} =$	12.6 in <sup>2</sup>
Area of steel at endspan (effective flange)	$A_{se} =$	12.4 in <sup>2</sup>
Area of temperature and shrinkage steel (12" width)	$A_s =$	0.2 in <sup>2</sup>

#### Cross-sectional Properties

##### NON-COMPOSITE BEAM

Area of cross-section of beam	A =	767.0 in <sup>2</sup>
Overall depth of beam	H =	72.0 in
Moment of Inertia	I =	539,947 in <sup>4</sup>
Distance from centroid to extreme bottom fiber	$y_b =$	36.6 in
Distance from centroid to extreme top fiber	$y_t =$	35.4 in
Section modulus for the extreme bottom fiber	$S_b =$	14915.0 in <sup>3</sup>
Section modulus for the extreme top fiber	$S_t =$	15421.0 in <sup>3</sup>
Weight	$W_t =$	799.0 plf
Modulus of Elasticity = $33000 \cdot (W_c^{1.5}) \cdot (\sqrt{f'_c})$		
cast-in-place concrete deck	$E_{cs} =$	3708 ksi
precast beam at release	$E_{ci} =$	4496 ksi
precast beam at service loads	$E_c =$	5072 ksi



### COMPOSITE BEAM

Effective Flange Width	$b_f =$	111.0 in	*min of three criteria
Modular Ratio = $E_{cs}/E_c$	$n =$	0.7309	
Transformed flange width	$=$	81.1 in	
Transformed flange area	$=$	608.5 in <sup>2</sup>	
Transformed haunch width	$=$	30.7 in	
Transformed haunch area	$=$	15.3 in <sup>2</sup>	

	Transformed Area	$y_b$	$Ay_b$	$A(y_{bc}-y_b)^2$	$I$	$I + A(y_{bc}-y_b)^2$
Beam	767.0 in <sup>2</sup>	36.60 in	28,072.2 in <sup>3</sup>	241,398 in <sup>4</sup>	539,947 in <sup>4</sup>	781,345 in <sup>4</sup>
Haunch	15.3 in <sup>2</sup>	72.25 in	1,109.0 in <sup>3</sup>	4,923 in <sup>4</sup>	0.33 in <sup>4</sup>	4,924 in <sup>4</sup>
Deck	608.5 in <sup>2</sup>	76.25 in	46,399.2 in <sup>3</sup>	292,099 in <sup>4</sup>	2,950 in <sup>4</sup>	295,049 in <sup>4</sup>
Total	1390.9 in <sup>2</sup>		75,580.5 in <sup>3</sup>			1,081,318 in <sup>4</sup>

Total area of Composite Section	$A_c =$	1391 in <sup>2</sup>
Overall Depth of the Composite Section	$h_c =$	80 in
Moment of Inertia	$I_c =$	1,081,318 in <sup>4</sup>
Distance from centroid to extreme <u>bottom</u> fiber of beam	$y_{bc} =$	54.34 in
Distance from centroid to extreme <u>top</u> fiber of beam	$y_{tg} =$	17.66 in
Distance from centroid to extreme <u>top</u> fiber of slab	$y_{tc} =$	25.66 in
Section modulus for the extreme <u>bottom</u> fiber of beam	$S_{bc} =$	19,898.9 in <sup>3</sup>
Section modulus for the extreme <u>top</u> fiber of beam	$S_{tg} =$	61,232.0 in <sup>3</sup>
Section modulus for the extreme <u>top</u> fiber slab	$S_{tc} =$	57,652.8 in <sup>3</sup>

### DECK (as 12" beam)

Reinforcing per 12"		at midspan	at beams
Layer 1 (Bottom)	$A_s =$	0.3 in <sup>2</sup>	0.3 in <sup>2</sup>
Layer 2 (Top)	$A_s =$	0.2 in <sup>2</sup>	0.2 in <sup>2</sup>

Modulus of Elasticity = $33000 \cdot (W_c^{1.5}) \cdot (\sqrt{f'_c})$ cast-in-place concrete deck	$E_{cs} =$	3708 ksi
--	------------	----------

Moment of Inertia	$I_g =$	324 in <sup>4</sup>	
Distance from centroid to extreme <u>bottom</u> fiber of deck	$y_b =$	3.44 in	
Distance from centroid to extreme <u>top</u> fiber of deck	$y_t =$	4.56 in	
Modulus of Rupture	$f_r =$	458.7 psi	
Cracking Moment	$M_{CR} =$	3.6 ft-kips	2.7 ft-kips
Max negative moment at loading stage	$M_a =$	16.9 ft-kips	21.1 ft-kips
Cracking Moment of Inertia	$I_{cr} =$	87 in <sup>4</sup>	87 in <sup>4</sup>
Effective Moment of Inertia	$I_e =$	90 in <sup>4</sup>	88 in <sup>4</sup>
Effective Moment of Inertia for Continuous Beam	$I_e =$	89 in <sup>4</sup>	

### Shear Forces and Bending Moments

#### DEAD LOADS

Beam self-weight	$w_{beam} =$	0.799 k/f
8 in. deck weight	$w_{deck} =$	1.200 k/f
1/2 in. haunch weight	$w_{haunch} =$	0.022 k/f

LRFD Specifications: Art. 4.6.2.2.1

Width of Deck Constant		OK
Number of beams is not less than four $N_b =$	4	OK
Roadway part of the overhang, $d_o \leq 3.0$ ft, $d_o =$	1.5	OK
Curvature in plans is less than $4^\circ =$	0	OK
Cross-section of the bridge is consistent with one of the cross sections given by LRFD specs		OK

Barrier and wearing surface loads are equally distributed among the 4 beams

Barrier Wt	$W_t =$	0.150 k/f
Dead load of future wearing surface	$DW =$	0.263 k/f

### LIVE LOADS

Fire truck live load front load (Point A)	$P_{live} =$	48.0 kips
Fire truck live load back load (Point B)	$P_{live} =$	22.0 kips
distance between two loads		19.2 ft
distance from nearest edge to point A	$x_a =$	59.0 ft
distance from nearest edge to point B	$x_b =$	39.8 ft
LRFD Specifications: Art. 4.6.2.2.1		
Width of Deck Constant		OK
Number of beams is not less than four $N_b =$	4	OK
Beams are parallel and approximately of the same stiffness		OK
Roadway part of the overhang, $d_o \leq 3.0$ ft, $d_e =$	1.5	OK
Curvature in plans is less than $4^\circ =$	0	OK

Barrier and wearing surface loads are equally distributed among the 4 beams

Bridge Type-- "k" (LRFD Table 4.6.2.2.1-1)

Number of design lanes = $w/12$	=	3 lanes
---------------------------------	---	---------

### Distribution Factor for Bending Moment:

Beams spacing	$S =$	12.0 ft
Depth of concrete slab	$t_s =$	7.5 in
Beam Span	$L =$	120.0 ft
Number of Beams	$N_b =$	4
Modular ratio between beam & deck materials	$n =$	1.3681
Longitudinal stiffness parameter	$K_g =$	2,388,355.43 in <sup>4</sup>

at center span:

$$DFM = 0.75 + \left(\frac{S}{9.5}\right)^{0.6} + \left(\frac{S}{L}\right)^{0.2} + \left(\frac{K_g}{12 * L * t_s^3}\right)^{0.1}$$

DFM =	0.907 lanes/beam
-------	------------------

0.905 Controls

one design lane loaded:

$$DFM = 0.75 + \left(\frac{S}{14}\right)^{0.4} * \left(\frac{S}{L}\right)^{0.3} * \left(\frac{K_g}{12 * L * t_s^3}\right)^{0.1}$$

DFM =	0.615 lanes/beam
-------	------------------

### Distribution Factor for Shear Force

both end spans and center span:

$$DFV = 0.2 + \left(\frac{S}{12}\right) - \left(\frac{S}{35}\right)^2$$

DFV =	1.082 lanes/beam
-------	------------------

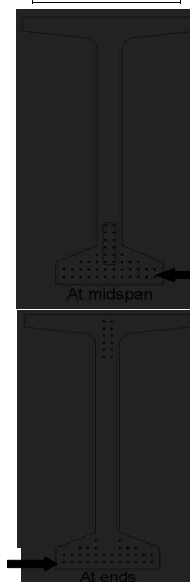
1.082 Controls

one design lane loaded:

$$DFV = 0.36 + \left(\frac{S}{25}\right)$$

DFV =	0.840 lanes/beam
-------	------------------

from bottom	At Midspan		At Ends	
	No. of	Distance from Bottom	No. of	Distance from Bottom
layer 1	12	2	12	2
layer 2	12	4	12	4
layer 3	8	6	6	6
layer 4	4	8	2	8
layer 5	2	10	-	-
layer 6	2	12	-	-
layer 7	2	14	-	-
layer 8	2	16	-	-
layer 9	-	-	2	60
layer 10	-	-	2	62
layer 11	-	-	2	64
layer 12	-	-	2	66
layer 13	-	-	2	68
layer 14	-	-	2	70
<b>Harped Strand Group (included in above totals)</b>				
layer 3	2	6		
layer 4	2	8		
layer 5	2	10		
layer 6	2	12		
layer 7	2	14		
layer 8	2	16		



layer 1

distance from the center of gravity of strands to the bottom fiber of the beam = 7% of the beam depth  
strand eccentricity at midspan =  $(y_b - y_{bs})$

$y_{bs} =$	5.82 in
$e_c =$	30.78 in

**Prestress Losses**

**ELASTIC SHORTENING**

assumed loss	=	9.00%
--------------	---	-------

Force per strand at transfer

layer 1	=	28.9 kips
layer 2	=	28.9 kips
layer 3	=	28.9 kips
layer 4	=	28.9 kips
layer 5	=	28.9 kips
layer 6	=	28.9 kips
layer 7	=	28.9 kips
layer 8	=	28.9 kips
layer 9	=	28.9 kips
layer 10	=	28.9 kips
layer 11	=	28.9 kips
layer 12	=	28.9 kips
layer 13	=	28.9 kips
layer 14	=	28.9 kips

		at midspan	at endspan
Total prestressing force at release	$P_i =$	1271.6 kips	1271.6 kips
Sum of concrete stresses at the center of gravity of prestressing tendons due to prestressing force at transfer and the self-weight of the member at sections of maximum moment	$f_{cgp} =$	2.938 ksi	2.938 ksi

Loss due to shortening

		at midspan	at endspan
layer 1	$\Delta f_{pES} =$	17.0 ksi	17.0 ksi
layer 2	$\Delta f_{pES} =$	17.0 ksi	17.0 ksi
layer 3	$\Delta f_{pES} =$	17.0 ksi	17.0 ksi
layer 4	$\Delta f_{pES} =$	17.0 ksi	17.0 ksi
layer 5	$\Delta f_{pES} =$	17.0 ksi	
layer 6	$\Delta f_{pES} =$	17.0 ksi	
layer 7	$\Delta f_{pES} =$	17.0 ksi	
layer 8	$\Delta f_{pES} =$	17.0 ksi	
layer 9	$\Delta f_{pES} =$		17.0 ksi
layer 10	$\Delta f_{pES} =$		17.0 ksi
layer 11	$\Delta f_{pES} =$		17.0 ksi
layer 12	$\Delta f_{pES} =$		17.0 ksi
layer 13	$\Delta f_{pES} =$		17.0 ksi
layer 14	$\Delta f_{pES} =$		17.0 ksi

**SHRINKAGE**

Shrinkage = $(17 - 0.15 \times \text{Relative Humidity})$	$\Delta f_{pSR} =$	6.5 ksi	← assume relative humidity = 70%
---	--------------------	---------	----------------------------------

**CREEP OF CONCRETE**

Change of stresses at center of gravity of prestressing due to permanent loads except the loads acting at time of applying prestressing force, calculated at the same section as $f_{cgp}$	$\Delta f_{cdp} =$	1.563 ksi	
		at midspan	at endspan
loss due to creep	$\Delta f_{pCR} =$	24.3 ksi	24.3 ksi

**RELAXATION OF PRESTRESSING STRANDS**

loss due to relaxation after transfer		at midspan	at endspan
layer 1	$\Delta f_{pR2} =$	2.1 ksi	2.1 ksi
layer 2	$\Delta f_{pR2} =$	2.1 ksi	2.1 ksi
layer 3	$\Delta f_{pR2} =$	2.1 ksi	2.1 ksi
layer 4	$\Delta f_{pR2} =$	2.1 ksi	2.1 ksi
layer 5	$\Delta f_{pR2} =$	2.1 ksi	
layer 6	$\Delta f_{pR2} =$	2.1 ksi	
layer 7	$\Delta f_{pR2} =$	2.1 ksi	
layer 8	$\Delta f_{pR2} =$	2.1 ksi	
layer 9	$\Delta f_{pR2} =$		2.1 ksi
layer 10	$\Delta f_{pR2} =$		2.1 ksi
layer 11	$\Delta f_{pR2} =$		2.1 ksi
layer 12	$\Delta f_{pR2} =$		2.1 ksi
layer 13	$\Delta f_{pR2} =$		2.1 ksi
layer 14	$\Delta f_{pR2} =$		2.1 ksi

**TOTAL LOSSES AT TRANSFER**

total loss  $\Delta f_{pES} = \Delta f_{pi}$

stress in tendons after transfer  $f_{pt} = f_{pi} - \Delta f_{pi}$

		at midspan	at endspan
layer 1	$f_{pt} =$	190.6 ksi	190.6 ksi
layer 2	$f_{pt} =$	190.6 ksi	190.6 ksi
layer 3	$f_{pt} =$	190.6 ksi	190.6 ksi
layer 4	$f_{pt} =$	190.6 ksi	190.6 ksi
layer 5	$f_{pt} =$	190.6 ksi	
layer 6	$f_{pt} =$	190.6 ksi	
layer 7	$f_{pt} =$	190.6 ksi	
layer 8	$f_{pt} =$	190.6 ksi	
layer 9	$f_{pt} =$		190.6 ksi
layer 10	$f_{pt} =$		190.6 ksi
layer 11	$f_{pt} =$		190.6 ksi
layer 12	$f_{pt} =$		190.6 ksi
layer 13	$f_{pt} =$		190.6 ksi
layer 14	$f_{pt} =$		190.6 ksi

force per strand =  $f_{pt} \cdot \text{strand area}$

		at midspan	at endspan
layer 1	=	29.2 kips	29.2 kips
layer 2	=	29.2 kips	29.2 kips
layer 3	=	29.2 kips	29.2 kips
layer 4	=	29.2 kips	29.2 kips
layer 5	=	29.2 kips	
layer 6	=	29.2 kips	
layer 7	=	29.2 kips	
layer 8	=	29.2 kips	
layer 9	=		29.2 kips
layer 10	=		29.2 kips
layer 11	=		29.2 kips
layer 12	=		29.2 kips
layer 13	=		29.2 kips
layer 14	=		29.2 kips
Total prestressing force after transfer	$P_i =$	1284.8 kips	1284.8 kips

Initial loss =  $(\Delta f_{pi}) / (f_{pi})$

		at midspan	at endspan
layer 1	% =	8.2%	8.2%
layer 2	% =	8.2%	8.2%
layer 3	% =	8.2%	8.2%
layer 4	% =	8.2%	8.2%
layer 5	% =	8.2%	
layer 6	% =	8.2%	
layer 7	% =	8.2%	
layer 8	% =	8.2%	
layer 9	% =		8.2%
layer 10	% =		8.2%
layer 11	% =		8.2%
layer 12	% =		8.2%
layer 13	% =		8.2%
layer 14	% =		8.2%

OK  
OK  
OK  
OK  
OK  
OK  
OK  
OK  
OK  
OK  
OK  
OK  
OK  
OK  
OK



**TOTAL LOSSES AT SERVICE LOADS**

Total Losses		at midspan	at endspan
layer 1	$\Delta f_{pT} =$	49.9 ksi	49.9 ksi
layer 2	$\Delta f_{pT} =$	49.9 ksi	49.9 ksi
layer 3	$\Delta f_{pT} =$	49.9 ksi	49.9 ksi
layer 4	$\Delta f_{pT} =$	49.9 ksi	49.9 ksi
layer 5	$\Delta f_{pT} =$	49.9 ksi	
layer 6	$\Delta f_{pT} =$	49.9 ksi	
layer 7	$\Delta f_{pT} =$	49.9 ksi	
layer 8	$\Delta f_{pT} =$	49.9 ksi	
layer 9	$\Delta f_{pT} =$		49.9 ksi
layer 10	$\Delta f_{pT} =$		49.9 ksi
layer 11	$\Delta f_{pT} =$		49.9 ksi
layer 12	$\Delta f_{pT} =$		49.9 ksi
layer 13	$\Delta f_{pT} =$		49.9 ksi
layer 14	$\Delta f_{pT} =$		49.9 ksi

Stress in tendon after all losses =  $f_{pr} - \Delta f_{pt}$

		at midspan	at endspan
layer 1	$f_{pe} =$	157.7 ksi	157.7 ksi
layer 2	$f_{pe} =$	157.7 ksi	157.7 ksi
layer 3	$f_{pe} =$	157.7 ksi	157.7 ksi
layer 4	$f_{pe} =$	157.7 ksi	157.7 ksi
layer 5	$f_{pe} =$	157.7 ksi	
layer 6	$f_{pe} =$	157.7 ksi	
layer 7	$f_{pe} =$	157.7 ksi	
layer 8	$f_{pe} =$	157.7 ksi	
layer 9	$f_{pe} =$		157.7 ksi
layer 10	$f_{pe} =$		157.7 ksi
layer 11	$f_{pe} =$		157.7 ksi
layer 12	$f_{pe} =$		157.7 ksi
layer 13	$f_{pe} =$		157.7 ksi
layer 14	$f_{pe} =$		157.7 ksi

check prestressing stress limit at service limit state:  $f_{pe} \leq 0.8 f_{py}$

layer 1	=	199.7 ksi
layer 2	=	199.7 ksi
layer 3	=	199.7 ksi
layer 4	=	199.7 ksi
layer 5	=	199.7 ksi
layer 6	=	199.7 ksi
layer 7	=	199.7 ksi
layer 8	=	199.7 ksi
layer 9	=	199.7 ksi
layer 10	=	199.7 ksi
layer 11	=	199.7 ksi
layer 12	=	199.7 ksi
layer 13	=	199.7 ksi
layer 14	=	199.7 ksi

OK  
OK  
OK  
OK  
OK  
OK  
OK  
OK  
OK  
OK  
OK  
OK  
OK  
OK

force per strand =  $f_{pe} \cdot \text{strand area}$

		at midspan	at endspan
layer 1	=	24.1 kips	24.1 kips
layer 2	=	24.1 kips	24.1 kips
layer 3	=	24.1 kips	24.1 kips
layer 4	=	24.1 kips	24.1 kips
layer 5	=	24.1 kips	
layer 6	=	24.1 kips	
layer 7	=	24.1 kips	
layer 8	=	24.1 kips	
layer 9	=		24.1 kips
layer 10	=		24.1 kips
layer 11	=		24.1 kips
layer 12	=		24.1 kips
layer 13	=		24.1 kips
layer 14	=		24.1 kips

		at midspan	at endspan
Total prestressing force after all losses	$P_{pe} =$	1061.6 kips	1061.6 kips
Final losses, % = $(\Delta f_{pT})/(f_{pi})$			
layer 1	% =	24.0%	24.0%
layer 2	% =	24.0%	24.0%
layer 3	% =	24.0%	24.0%
layer 4	% =	24.0%	24.0%
layer 5	% =	24.0%	
layer 6	% =	24.0%	
layer 7	% =	24.0%	
layer 8	% =	24.0%	
layer 9	% =		24.0%
layer 10	% =		24.0%
layer 11	% =		24.0%
layer 12	% =		24.0%
layer 13	% =		24.0%
layer 14	% =		24.0%
Average final losses, %	% =	24.0%	24.0%

### Stresses at Transfer

#### STRESS LIMITS FOR CONCRETE

Compression = $0.6f_{ci}$	$f_{ci} =$	3.300 ksi
Tension		
without bonded reinforcement = $-0.0948\sqrt{f_{ci}} \leq -0.2$	=	-0.200 ksi
with bonded auxiliary reinforcement = $-0.22\sqrt{f_{ci}}$	=	-0.016 ksi

#### STRESSES AT TRANSFER LENGTH SECTION

Transfer Length = $60 \times (\text{strand diameter})$	=	2.5 ft	} Calcs for eccentricity (see 9.6.7.2)
Bending moment at transfer length	$M_g =$	116.4 ft-kips	
center of 12 strands to top fiber of beam at the end	=	7.00 in	
center of 12 strands to bottom fiber of beam at the harp point	=	11.00 in	
center of 12 strands and top fiber of beam at transfer length	=	10.78 in	
center of gravity of 32 strands and bottom fiber of beam	=	3.88 in	
center of gravity of all strands and the bottom fiber of beam at transfer length	=	19.51 in	
center of gravity of all strands and the bottom fiber of beam at the end	=	20.55 in	
Eccentricity of the strand group at transfer length:	$e_{11} =$	17.09 in	}
Eccentricity at end of beam:	$e =$	16.05 in	

$$f_t = \frac{P_i}{A} - \frac{P_i e}{S_t} + \frac{M_g}{S_t}$$

$$f_b = \frac{P_i}{A} + \frac{P_i e}{S_b} - \frac{M_g}{S_b}$$

		at midspan	at endspan	
Top stress at top fiber of beam	$f_t =$	0.342 ksi	0.342 ksi	OK
Bottom stress at bottom fiber of the beam	$f_b =$	3.021 ksi	3.021 ksi	OK

#### STRESSES AT HARP POINT

Bending moment due to beam weight at 0.3L	$M_g =$	1188.0 ft-kips		
Top stress at top fiber of beam	$f_t =$	0.035 ksi	0.035 ksi	OK
Bottom stress at bottom fiber of the beam	$f_b =$	3.300 ksi	3.300 ksi	OK

#### STRESSES AT MIDSPAN

Bending moment due to beam weight at 0.5L	$M_g =$	1414.3 ft-kips		
Top stress at top fiber of beam	$f_t =$	0.220 ksi	0.211 ksi	OK
Bottom stress at bottom fiber of the beam	$f_b =$	3.144 ksi	3.189 ksi	OK

### HOLD-DOWN FORCES

assume stress in strand before losses =  $0.8f_u$

layer 1	=	221.4 ksi
layer 2	=	221.4 ksi
layer 3	=	221.4 ksi
layer 4	=	221.4 ksi
layer 5	=	221.4 ksi
layer 6	=	221.4 ksi
layer 7	=	221.4 ksi
layer 8	=	221.4 ksi
layer 9	=	221.4 ksi
layer 10	=	221.4 ksi
layer 11	=	221.4 ksi
layer 12	=	221.4 ksi
layer 13	=	221.4 ksi
layer 14	=	221.4 ksi

prestress force per strand before any losses:

layer 1	=	33.9 kips
layer 2	=	33.9 kips
layer 3	=	33.9 kips
layer 4	=	33.9 kips
layer 5	=	33.9 kips
layer 6	=	33.9 kips
layer 7	=	33.9 kips
layer 8	=	33.9 kips
layer 9	=	33.9 kips
layer 10	=	33.9 kips
layer 11	=	33.9 kips
layer 12	=	33.9 kips
layer 13	=	33.9 kips
layer 14	=	33.9 kips
Harp Angle	$\psi =$	7.2 °

Hold-down force/strand

layer 1	=	4.4 kips/strand
layer 2	=	4.4 kips/strand
layer 3	=	4.4 kips/strand
layer 4	=	4.4 kips/strand
layer 5	=	4.4 kips/strand
layer 6	=	4.4 kips/strand
layer 7	=	4.4 kips/strand
layer 8	=	4.4 kips/strand
layer 9	=	4.4 kips/strand
layer 10	=	4.4 kips/strand
layer 11	=	4.4 kips/strand
layer 12	=	4.4 kips/strand
layer 13	=	4.4 kips/strand
layer 14	=	4.4 kips/strand
Total hold-down force	=	53.39 kips

### Stresses at Service Loads

#### STRESS LIMITS FOR CONCRETE

##### Compression:

Due to permanent loads for load combination Service I

for the precast beam	=	3.150 ksi
for deck	=	1.683 ksi

Due to permanent and transient loads for load combination Service I

for the precast beam	=	4.200 ksi
for deck	=	2.244 ksi

##### Tension:

Load Combination Service III

for the precast beam	=	-0.016 ksi
----------------------	---	------------

STRESSES AT MIDSPAN			
Compression stresses at top fiber of beam	at midspan	at endspan	
$f_x = \frac{P_{ps}}{A} - \frac{P_{ps}e}{S_x} + \frac{(M_D + M_L)}{S_x} + \frac{(M_{ws} + M_D)}{S_{xg}}$			
Due to permanent loads	$f_{ig} =$	2.042 ksi	2.042 ksi
$f_{ig} = \frac{P_{ps}}{A} - \frac{P_{ps}e}{S_x} + \frac{(M_D + M_L)}{S_x} + \frac{(M_{ws} + M_D)}{S_{xg}} + \frac{(M_{LL+I})}{S_{xg}}$			
Due to permanent loads and transient loads	$f_{ig} =$	2.456 ksi	2.456 ksi
Compression stresses at top fiber of deck	at midspan	at endspan	
$f_{tc} = \frac{(M_{ws} + M_D)}{S_{xc}}$			
Due to permanent loads	$f_{tc} =$	0.042 ksi	0.042 ksi
$f_{tc} = \frac{(M_{ws} + M_D + M_{LL+I})}{S_{xc}}$			
Due to permanent loads and transient loads	$f_{tc} =$	0.482 ksi	0.482 ksi
Tension stresses at top fiber of deck	at midspan	at endspan	
$f_{tr} = \frac{P_{ps}}{A} + \frac{P_{ps}e}{S_y} - \frac{(M_D + M_L)}{S_y} - \frac{(M_{ws} + M_D + 0.5M_{LL+I})}{S_{yc}}$			
Load Combination Service III	$f_b =$	-0.397 ksi	-0.397 ksi

OK

OK

OK

OK

OK

**Strength Limit State**

POSITIVE MOMENT SECTION		
$M_u = 1.25DC + 1.5DW + 1.75(LL+IM)$	$M_u =$	8381.5 ft-kips
effective length factor for compression members		
layer 1	k =	0.28
layer 2	k =	0.28
layer 3	k =	0.28
layer 4	k =	0.28
layer 5	k =	0.28
layer 6	k =	0.28
layer 7	k =	0.28
layer 8	k =	0.28
layer 9	k =	0.28
layer 10	k =	0.28
layer 11	k =	0.28
layer 12	k =	0.28
layer 13	k =	0.28
layer 14	k =	0.28
	c =	6.1 ft-kips
average stress in prestressing steel		
layer 1	$f_{ps} =$	270.5 ksi
layer 2	$f_{ps} =$	270.5 ksi
layer 3	$f_{ps} =$	270.5 ksi
layer 4	$f_{ps} =$	270.5 ksi
layer 5	$f_{ps} =$	270.5 ksi
layer 6	$f_{ps} =$	270.5 ksi
layer 7	$f_{ps} =$	270.5 ksi
layer 8	$f_{ps} =$	270.5 ksi
layer 9	$f_{ps} =$	270.5 ksi
layer 10	$f_{ps} =$	270.5 ksi
layer 11	$f_{ps} =$	270.5 ksi
layer 12	$f_{ps} =$	270.5 ksi
layer 13	$f_{ps} =$	270.5 ksi
layer 14	$f_{ps} =$	270.5 ksi
nominal flexure resistance		
$M_r = \Phi M_n, \Phi = 1.00$	$\Phi M_n =$	10865.1 ft-kips
NEGATIVE MOMENT SECTION		
$M_u = 1.25DC + 1.5DW + 1.75(LL+IM)$	$M_u =$	-4837.2 ft-kips
	a =	0.20 in
	$\Phi M_n =$	5144.4 ft-kips

OK

OK

### Shear Design

CRITICAL SECTION AT 0.59			
$V_u = 1.25DC + 1.5DW + 1.75(LL+IM)$	$V_u =$	405.0 kips	
$M_u = 1.25DC + 1.5DW + 1.75(LL+IM)$	$M_u =$	-2684.4 ft-kips	
or			
$V_u = 1.25DC + 1.5DW + 1.75(LL+IM)$	$V_u =$	364.8 kips	
$M_u = 1.25DC + 1.5DW + 1.75(LL+IM)$	$M_u =$	-2877.0 ft-kips	
max shear	$V_u =$	405.0 kips	
max moment	$M_u =$	2877.0 ft-kips	
Shear depth	$d_v =$	73.19 in	
Applied factored normal force at the section	$N_u =$	0	
Angle of diagonal compressive stresses	$\theta =$	36.00 °	

### STRAIN IN FLEXURAL TENSION REINFORCEMENT

$\epsilon_x = \frac{M_u + 0.5N_u + 0.5V_u \cot \theta - A_{ps} f_{ps}}{Z_x A_s + Z_y A_{ps}} \leq 0.002$			
		at midspan	at endspan
resultant compressive stress at centroid	$f_{pc} =$	1.001 ksi	1.001 ksi
effective stress in prestressing strand after all losses			
layer 1	$f_{po} =$	162.8 ksi	162.8 ksi
layer 2	$f_{po} =$	162.8 ksi	162.8 ksi
layer 3	$f_{po} =$	162.8 ksi	162.8 ksi
layer 4	$f_{po} =$	162.8 ksi	162.8 ksi
layer 5	$f_{po} =$	162.8 ksi	
layer 6	$f_{po} =$	162.8 ksi	
layer 7	$f_{po} =$	162.8 ksi	
layer 8	$f_{po} =$	162.8 ksi	
layer 9	$f_{po} =$		162.8 ksi
layer 10	$f_{po} =$		162.8 ksi
layer 11	$f_{po} =$		162.8 ksi
layer 12	$f_{po} =$		162.8 ksi
layer 13	$f_{po} =$		162.8 ksi
layer 14	$f_{po} =$		162.8 ksi
strain in flexural tension		at midspan	at endspan
layer 1	$\epsilon_x =$	0.002000	0.002000
layer 2	$\epsilon_x =$	0.002000	0.002000
layer 3	$\epsilon_x =$	0.002000	0.002000
layer 4	$\epsilon_x =$	0.002000	0.002000
layer 5	$\epsilon_x =$	0.002000	
layer 6	$\epsilon_x =$	0.002000	
layer 7	$\epsilon_x =$	0.002000	
layer 8	$\epsilon_x =$	0.002000	
layer 9	$\epsilon_x =$		0.002000
layer 10	$\epsilon_x =$		0.002000
layer 11	$\epsilon_x =$		0.002000
layer 12	$\epsilon_x =$		0.002000
layer 13	$\epsilon_x =$		0.002000
layer 14	$\epsilon_x =$		0.002000

### Deflection and Camber

		at midspan	at endspan
Deflection due to Prestressing Force at Transfer	$\Delta_p =$	3.97 in	3.97 in
Deflection due to Beam Self-Weight at Transfer	$\Delta_g =$	-1.49 in	
Deflection due to Beam Self-Weight at Erection	$\Delta_g =$	-1.44 in	
Deflection due to Haunch and Deck	$\Delta_g =$	-1.95 in	
Deflection due to total self weight	$\Delta_{sw} =$	0.59 in	
Total Deflection at transfer	$\Delta =$	2.48 in	2.48 in
Total Deflection at erection	$\Delta =$	4.49 in	4.49 in

### Deck Deflection (assuming 12" beam)

Deflection due to Deck Self-Weight	$\Delta_g =$	-1.1006 in
Live load deflection limit = span/800	$=$	0.18 in
Deflection due to live load and impact	$\Delta_L =$	-0.21 in

OK

**Location: Fire above Deck Between Girders**  
**Beam Design: 1/2" Strand**  
**Fire Exposure Status: 1 Hour**

(PCI Bridge Design Manual Section 9.6)

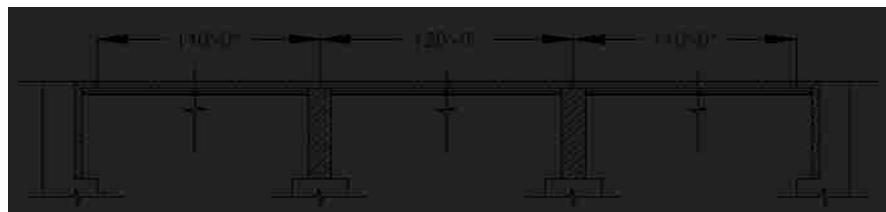


**Material Properties**

CAST-IN-PLACE SLAB		
Actual Thickness	$t_{as} =$	8.0 in
Wearing Surface	$=$	0.5 in
Structural thickness = Actual - Wearing Surface	$t_s =$	7.5 in
Compressive Strength	$f'_c =$	3.57 ksi
Unit Weight	$w_c =$	150.0 pcf
Stress factor of compression block	$\beta_1 =$	0.85

BEAMS: AASHTO-PCI, BT-72 BULB-TEE		
Strength at release	$f'_{ci} =$	5.5 ksi
Strength at 28 days	$f'_c =$	7 ksi
Unit Weight	$w_c =$	150.0 pcf
Overall Beam Length:		
@ end spans	$L =$	110 ft
@ center span	$L =$	119 ft
Design Spans:		
Non-composite beam @ end spans	$L =$	109 ft
Non-composite beam @ center span	$L =$	118 ft
Composite beam @ end spans	$L =$	110 ft
Composite beam @ center span	$L =$	120 ft
Beam Spacing	$S =$	12 ft



**PRESTRESSING STRANDS**

Diameter of single strand		d =	0.5 in
Area of single strand		A =	0.153 in <sup>2</sup>
Temperature of Layer			
	layer 1 (bottom)	T =	68.00 °F
	layer 2	T =	68.00 °F
	layer 3	T =	68.00 °F
	layer 4	T =	68.00 °F
	layer 5	T =	68.00 °F
	layer 6	T =	68.00 °F
	layer 7	T =	68.00 °F
	layer 8	T =	68.00 °F
	layer 9	T =	68.00 °F
	layer 10	T =	68.00 °F
	layer 11	T =	68.00 °F
	layer 12	T =	68.00 °F
	layer 13	T =	68.00 °F
	layer 14	T =	68.00 °F
Ultimate Strength			
initial =	277 ksi		
	layer 1 (bottom)	f <sub>pu</sub> =	277 ksi
	layer 2	f <sub>pu</sub> =	277 ksi
	layer 3	f <sub>pu</sub> =	277 ksi
	layer 4	f <sub>pu</sub> =	277 ksi
	layer 5	f <sub>pu</sub> =	277 ksi
	layer 6	f <sub>pu</sub> =	277 ksi
	layer 7	f <sub>pu</sub> =	277 ksi
	layer 8	f <sub>pu</sub> =	277 ksi
	layer 9	f <sub>pu</sub> =	277 ksi
	layer 10	f <sub>pu</sub> =	277 ksi
	layer 11	f <sub>pu</sub> =	277 ksi
	layer 12	f <sub>pu</sub> =	277 ksi
	layer 13	f <sub>pu</sub> =	277 ksi
	layer 14	f <sub>pu</sub> =	277 ksi
Yield Strength			
initial =	250 ksi		
	layer 1 (bottom)	f <sub>py</sub> =	250 ksi
	layer 2	f <sub>py</sub> =	250 ksi
	layer 3	f <sub>py</sub> =	250 ksi
	layer 4	f <sub>py</sub> =	250 ksi
	layer 5	f <sub>py</sub> =	250 ksi
	layer 6	f <sub>py</sub> =	250 ksi
	layer 7	f <sub>py</sub> =	250 ksi
	layer 8	f <sub>py</sub> =	250 ksi
	layer 9	f <sub>py</sub> =	250 ksi
	layer 10	f <sub>py</sub> =	250 ksi
	layer 11	f <sub>py</sub> =	250 ksi
	layer 12	f <sub>py</sub> =	250 ksi
	layer 13	f <sub>py</sub> =	250 ksi
	layer 14	f <sub>py</sub> =	250 ksi
<b>Stress Limits:</b>			
before transfer	≤ 0.75f <sub>pu</sub> (initial = 207.6)		
	layer 1 (bottom)	f <sub>pi</sub> =	207.6 ksi
	layer 2	f <sub>pi</sub> =	207.6 ksi
	layer 3	f <sub>pi</sub> =	207.6 ksi
	layer 4	f <sub>pi</sub> =	207.6 ksi
	layer 5	f <sub>pi</sub> =	207.6 ksi
	layer 6	f <sub>pi</sub> =	207.6 ksi
	layer 7	f <sub>pi</sub> =	207.6 ksi
	layer 8	f <sub>pi</sub> =	207.6 ksi
	layer 9	f <sub>pi</sub> =	207.6 ksi
	layer 10	f <sub>pi</sub> =	207.6 ksi
	layer 11	f <sub>pi</sub> =	207.6 ksi
	layer 12	f <sub>pi</sub> =	207.6 ksi
	layer 13	f <sub>pi</sub> =	207.6 ksi
	layer 14	f <sub>pi</sub> =	207.6 ksi

at service limit state (after all losses)  $\leq 0.80f_{py}$  (initial = 199.7)

layer 1 (bottom)	$f_{pe} =$	199.7 ksi
layer 2	$f_{pe} =$	199.7 ksi
layer 3	$f_{pe} =$	199.7 ksi
layer 4	$f_{pe} =$	199.7 ksi
layer 5	$f_{pe} =$	199.7 ksi
layer 6	$f_{pe} =$	199.7 ksi
layer 7	$f_{pe} =$	199.7 ksi
layer 8	$f_{pe} =$	199.7 ksi
layer 9	$f_{pe} =$	199.7 ksi
layer 10	$f_{pe} =$	199.7 ksi
layer 11	$f_{pe} =$	199.7 ksi
layer 12	$f_{pe} =$	199.7 ksi
layer 13	$f_{pe} =$	199.7 ksi
layer 14	$f_{pe} =$	199.7 ksi

Modulus of Elasticity

initial = 25982 ksi

layer 1 (bottom)	E =	25982.0 ksi
layer 2	E =	25982.0 ksi
layer 3	E =	25982.0 ksi
layer 4	E =	25982.0 ksi
layer 5	E =	25982.0 ksi
layer 6	E =	25982.0 ksi
layer 7	E =	25982.0 ksi
layer 8	E =	25982.0 ksi
layer 9	E =	25982.0 ksi
layer 10	E =	25982.0 ksi
layer 11	E =	25982.0 ksi
layer 12	E =	25982.0 ksi
layer 13	E =	25982.0 ksi
layer 14	E =	25982.0 ksi

#### MILD STEEL REINFORCING BARS AT ENDSpan

Yield Strength

Layer 1 (Bottom)	$f_y =$	60.0 ksi	68.00 °F
Layer 2 (Top)	$f_y =$	57.6 ksi	820.00 °F

Modulus of Elasticity

E =	29000.0 ksi
-----	-------------

Layer 1 (Bottom)

Area of steel at midspan (effective flange)	$A_{sm} =$	2.79 in <sup>2</sup>
Area of steel at endspan (effective flange)	$A_{se} =$	2.48 in <sup>2</sup>
Area of temperature and shrinkage steel (12" width)	$A_s =$	0.31 in <sup>2</sup>

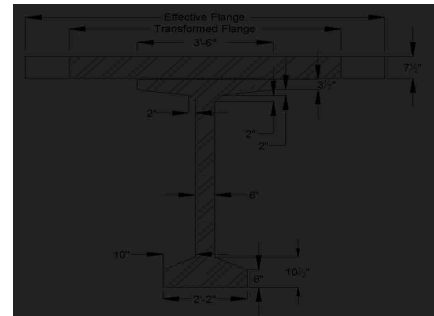
Layer 2 (Top)

Area of steel at midspan (effective flange)	$A_{sm} =$	12.6 in <sup>2</sup>
Area of steel at endspan (effective flange)	$A_{se} =$	12.4 in <sup>2</sup>
Area of temperature and shrinkage steel (12" width)	$A_s =$	0.2 in <sup>2</sup>

#### Cross-sectional Properties

##### NON-COMPOSITE BEAM

Area of cross-section of beam	A =	767.0 in <sup>2</sup>
Overall depth of beam	H =	72.0 in
Moment of Inertia	I =	539,947 in <sup>4</sup>
Distance from centroid to extreme <b>bottom</b> fiber	$y_b =$	36.6 in
Distance from centroid to extreme <b>top</b> fiber	$y_t =$	35.4 in
Section modulus for the extreme <b>bottom</b> fiber	$S_b =$	14915.0 in <sup>3</sup>
Section modulus for the extreme <b>top</b> fiber	$S_t =$	15421.0 in <sup>3</sup>
Weight	$W_t =$	799.0 plf
Modulus of Elasticity = $33000 \cdot (W_c^{1.5}) \cdot (\sqrt{f'_c})$		
cast-in-place concrete deck	$E_{cs} =$	3622 ksi
precast beam at release	$E_{ci} =$	4496 ksi
precast beam at service loads	$E_c =$	5072 ksi





### COMPOSITE BEAM

Effective Flange Width	$b_f =$	111.0 in	*min of three criteria
Modular Ratio = $E_{cs}/E_c$	$n =$	0.7141	
Transformed flange width	$=$	79.3 in	
Transformed flange area	$=$	594.5 in <sup>2</sup>	
Transformed haunch width	$=$	30.0 in	
Transformed haunch area	$=$	15.0 in <sup>2</sup>	

	Transformed Area	$y_b$	$Ay_b$	$A(y_{bc}-y_b)^2$	I	$I + A(y_{bc}-y_b)^2$
Beam	767.0 in <sup>2</sup>	36.60 in	28,072.2 in <sup>3</sup>	235,253 in <sup>4</sup>	539,947 in <sup>4</sup>	775,200 in <sup>4</sup>
Haunch	15.0 in <sup>2</sup>	72.25 in	1,083.5 in <sup>3</sup>	4,933 in <sup>4</sup>	0.33 in <sup>4</sup>	4,933 in <sup>4</sup>
Deck	594.5 in <sup>2</sup>	76.25 in	45,332.4 in <sup>3</sup>	291,335 in <sup>4</sup>	2,950 in <sup>4</sup>	294,284 in <sup>4</sup>
Total	1376.5 in <sup>2</sup>		74,488.2 in <sup>3</sup>			1,074,417 in <sup>4</sup>

Total area of Composite Section	$A_c =$	1377 in <sup>2</sup>
Overall Depth of the Composite Section	$h_c =$	80 in
Moment of Inertia	$I_c =$	1,074,417 in <sup>4</sup>
Distance from centroid to extreme <u>bottom</u> fiber of beam	$y_{bc} =$	54.11 in
Distance from centroid to extreme <u>top</u> fiber of beam	$y_{tg} =$	17.89 in
Distance from centroid to extreme <u>top</u> fiber of slab	$y_{tc} =$	25.89 in
Section modulus for the extreme <u>bottom</u> fiber of beam	$S_{bc} =$	19,854.9 in <sup>3</sup>
Section modulus for the extreme <u>top</u> fiber of beam	$S_{tg} =$	60,068.2 in <sup>3</sup>
Section modulus for the extreme <u>top</u> fiber slab	$S_{tc} =$	58,118.2 in <sup>3</sup>

### DECK (as 12" beam)

Reinforcing per 12"		at midspan	at beams
Layer 1 (Bottom)	$A_s =$	0.3 in <sup>2</sup>	0.3 in <sup>2</sup>
Layer 2 (Top)	$A_s =$	0.2 in <sup>2</sup>	0.2 in <sup>2</sup>

Modulus of Elasticity = $33000 \cdot (W_c^{1.5}) \cdot (\sqrt{f'_c})$ cast-in-place concrete deck	$E_{cs} =$	3622 ksi
--	------------	----------

Moment of Inertia	$I_g =$	249 in <sup>4</sup>
Distance from centroid to extreme <u>bottom</u> fiber of deck	$y_b =$	3.11 in
Distance from centroid to extreme <u>top</u> fiber of deck	$y_t =$	4.89 in
Modulus of Rupture	$f_r =$	448.1 psi
Cracking Moment	$M_{CR} =$	3.0 ft-kips
Max negative moment at loading stage	$M_a =$	16.9 ft-kips
Cracking Moment of Inertia	$I_{cr} =$	87 in <sup>4</sup>
Effective Moment of Inertia	$I_e =$	88 in <sup>4</sup>
Effective Moment of Inertia for Continuous Beam	$I_e =$	88 in <sup>4</sup>

### Shear Forces and Bending Moments

#### DEAD LOADS

Beam self-weight	$w_{beam} =$	0.799 k/f
8 in. deck weight	$w_{deck} =$	1.200 k/f
1/2 in. haunch weight	$w_{haunch} =$	0.022 k/f

LRFD Specifications: Art. 4.6.2.2.1

Width of Deck Constant		OK
Number of beams is not less than four $N_b =$	4	OK
Roadway part of the overhang, $d_o \leq 3.0$ ft, $d_o =$	1.5	OK
Curvature in plans is less than $4^\circ =$	0	OK
Cross-section of the bridge is consistent with one of the cross sections given by LRFD specs		OK

Barrier and wearing surface loads are equally distributed among the 4 beams

Barrier Wt	$W_t =$	0.150 k/f
Dead load of future wearing surface	$DW =$	0.263 k/f

### LIVE LOADS

Fire truck live load front load (Point A)	$P_{live} =$	48.0 kips
Fire truck live load back load (Point B)	$P_{live} =$	22.0 kips
distance between two loads		19.2 ft
distance from nearest edge to point A	$x_a =$	59.0 ft
distance from nearest edge to point B	$x_b =$	39.8 ft
LRFD Specifications: Art. 4.6.2.2.1		
Width of Deck Constant		OK
Number of beams is not less than four $N_b =$	4	OK
Beams are parallel and approximately of the same stiffness		OK
Roadway part of the overhang, $d_o \leq 3.0$ ft, $d_e =$	1.5	OK
Curvature in plans is less than $4^\circ =$	0	OK

Barrier and wearing surface loads are equally distributed among the 4 beams

Bridge Type-- "k" (LRFD Table 4.6.2.2.1-1)

Number of design lanes = $w/12$	=	3 lanes
---------------------------------	---	---------

### Distribution Factor for Bending Moment:

Beams spacing	$S =$	12.0 ft
Depth of concrete slab	$t_s =$	7.5 in
Beam Span	$L =$	120.0 ft
Number of Beams	$N_b =$	4
Modular ratio between beam & deck materials	$n =$	1.4003
Longitudinal stiffness parameter	$K_g =$	2,444,559.72 in <sup>4</sup>

at center span:

$$DFM = 0.75 + \left(\frac{S}{9.5}\right)^{0.6} + \left(\frac{S}{L}\right)^{0.2} + \left(\frac{K_g}{12 * L * t_s^3}\right)^{0.1}$$

DFM =	0.909 lanes/beam
-------	------------------

0.905 Controls

one design lane loaded:

$$DFM = 0.75 + \left(\frac{S}{14}\right)^{0.4} * \left(\frac{S}{L}\right)^{0.3} * \left(\frac{K_g}{12 * L * t_s^3}\right)^{0.1}$$

DFM =	0.617 lanes/beam
-------	------------------

### Distribution Factor for Shear Force

both end spans and center span:

$$DFV = 0.2 + \left(\frac{S}{12}\right) - \left(\frac{S}{35}\right)^2$$

DFV =	1.082 lanes/beam
-------	------------------

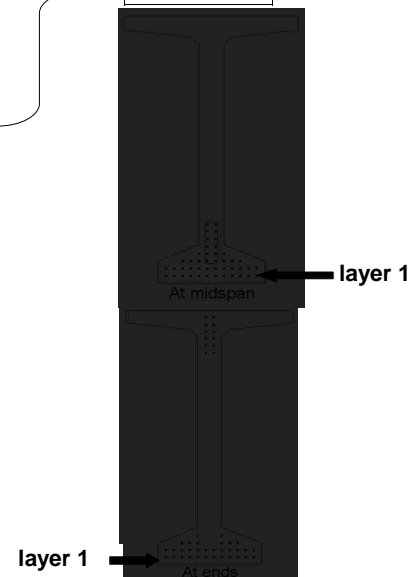
1.082 Controls

one design lane loaded:

$$DFV = 0.36 + \left(\frac{S}{25}\right)$$

DFV =	0.840 lanes/beam
-------	------------------

from bottom	At Midspan		At Ends	
	No. of	Distance from Bottom	No. of	Distance from Bottom
layer 1	12	2	12	2
layer 2	12	4	12	4
layer 3	8	6	6	6
layer 4	4	8	2	8
layer 5	2	10	-	-
layer 6	2	12	-	-
layer 7	2	14	-	-
layer 8	2	16	-	-
layer 9	-	-	2	60
layer 10	-	-	2	62
layer 11	-	-	2	64
layer 12	-	-	2	66
layer 13	-	-	2	68
layer 14	-	-	2	70
<b>Harped Strand Group (included in above totals)</b>				
layer 3	2	6		
layer 4	2	8		
layer 5	2	10		
layer 6	2	12		
layer 7	2	14		
layer 8	2	16		



distance from the center of gravity of strands to the bottom fiber of the beam = 7% of the beam depth  
strand eccentricity at midspan =  $(y_b - y_{bs})$

$y_{bs} =$	5.82 in
$e_c =$	30.78 in

### Prestress Losses

#### ELASTIC SHORTENING

assumed loss	=	9.00%
Force per strand at transfer		
layer 1	=	28.9 kips
layer 2	=	28.9 kips
layer 3	=	28.9 kips
layer 4	=	28.9 kips
layer 5	=	28.9 kips
layer 6	=	28.9 kips
layer 7	=	28.9 kips
layer 8	=	28.9 kips
layer 9	=	28.9 kips
layer 10	=	28.9 kips
layer 11	=	28.9 kips
layer 12	=	28.9 kips
layer 13	=	28.9 kips
layer 14	=	28.9 kips
		<b>at midspan</b>
		<b>at endspan</b>
Total prestressing force at release	$P_i =$	1271.6 kips
		1271.6 kips
Sum of concrete stresses at the center of gravity of prestressing tendons due to prestressing force at transfer and the self-weight of the member at sections of maximum moment	$f_{cgp} =$	2.938 ksi
		2.938 ksi
Loss due to shortening		
		<b>at midspan</b>
		<b>at endspan</b>
layer 1	$\Delta f_{pES} =$	17.0 ksi
layer 2	$\Delta f_{pES} =$	17.0 ksi
layer 3	$\Delta f_{pES} =$	17.0 ksi
layer 4	$\Delta f_{pES} =$	17.0 ksi
layer 5	$\Delta f_{pES} =$	17.0 ksi
layer 6	$\Delta f_{pES} =$	17.0 ksi
layer 7	$\Delta f_{pES} =$	17.0 ksi
layer 8	$\Delta f_{pES} =$	17.0 ksi
layer 9	$\Delta f_{pES} =$	17.0 ksi
layer 10	$\Delta f_{pES} =$	17.0 ksi
layer 11	$\Delta f_{pES} =$	17.0 ksi
layer 12	$\Delta f_{pES} =$	17.0 ksi
layer 13	$\Delta f_{pES} =$	17.0 ksi
layer 14	$\Delta f_{pES} =$	17.0 ksi

#### SHRINKAGE

Shrinkage =  $(17 - 0.15 \times \text{Relative Humidity})$   $\Delta f_{pSR} =$  6.5 ksi ← assume relative humidity = 70%

#### CREEP OF CONCRETE

Change of stresses at center of gravity of prestressing due to permanent loads except the loads acting at time of applying prestressing force, calculated at the same section as $f_{cgp}$	$\Delta f_{cdp} =$	1.563 ksi
		<b>at midspan</b>
		<b>at endspan</b>
loss due to creep	$\Delta f_{pCR} =$	24.3 ksi
		24.3 ksi

**RELAXATION OF PRESTRESSING STRANDS**

loss due to relaxation after transfer		at midspan	at endspan
layer 1	$\Delta f_{pR2} =$	2.1 ksi	2.1 ksi
layer 2	$\Delta f_{pR2} =$	2.1 ksi	2.1 ksi
layer 3	$\Delta f_{pR2} =$	2.1 ksi	2.1 ksi
layer 4	$\Delta f_{pR2} =$	2.1 ksi	2.1 ksi
layer 5	$\Delta f_{pR2} =$	2.1 ksi	
layer 6	$\Delta f_{pR2} =$	2.1 ksi	
layer 7	$\Delta f_{pR2} =$	2.1 ksi	
layer 8	$\Delta f_{pR2} =$	2.1 ksi	
layer 9	$\Delta f_{pR2} =$		2.1 ksi
layer 10	$\Delta f_{pR2} =$		2.1 ksi
layer 11	$\Delta f_{pR2} =$		2.1 ksi
layer 12	$\Delta f_{pR2} =$		2.1 ksi
layer 13	$\Delta f_{pR2} =$		2.1 ksi
layer 14	$\Delta f_{pR2} =$		2.1 ksi

**TOTAL LOSSES AT TRANSFER**

total loss  $\Delta f_{pES} = \Delta f_{pi}$

stress in tendons after transfer  $f_{pt} = f_{pi} - \Delta f_{pi}$

		at midspan	at endspan
layer 1	$f_{pt} =$	190.6 ksi	190.6 ksi
layer 2	$f_{pt} =$	190.6 ksi	190.6 ksi
layer 3	$f_{pt} =$	190.6 ksi	190.6 ksi
layer 4	$f_{pt} =$	190.6 ksi	190.6 ksi
layer 5	$f_{pt} =$	190.6 ksi	
layer 6	$f_{pt} =$	190.6 ksi	
layer 7	$f_{pt} =$	190.6 ksi	
layer 8	$f_{pt} =$	190.6 ksi	
layer 9	$f_{pt} =$		190.6 ksi
layer 10	$f_{pt} =$		190.6 ksi
layer 11	$f_{pt} =$		190.6 ksi
layer 12	$f_{pt} =$		190.6 ksi
layer 13	$f_{pt} =$		190.6 ksi
layer 14	$f_{pt} =$		190.6 ksi

force per strand =  $f_{pt} \cdot \text{strand area}$

		at midspan	at endspan
layer 1	=	29.2 kips	29.2 kips
layer 2	=	29.2 kips	29.2 kips
layer 3	=	29.2 kips	29.2 kips
layer 4	=	29.2 kips	29.2 kips
layer 5	=	29.2 kips	
layer 6	=	29.2 kips	
layer 7	=	29.2 kips	
layer 8	=	29.2 kips	
layer 9	=		29.2 kips
layer 10	=		29.2 kips
layer 11	=		29.2 kips
layer 12	=		29.2 kips
layer 13	=		29.2 kips
layer 14	=		29.2 kips
Total prestressing force after transfer	$P_i =$	1284.8 kips	1284.8 kips

Initial loss =  $(\Delta f_{pi}) / (f_{pi})$

		at midspan	at endspan
layer 1	% =	8.2%	8.2%
layer 2	% =	8.2%	8.2%
layer 3	% =	8.2%	8.2%
layer 4	% =	8.2%	8.2%
layer 5	% =	8.2%	
layer 6	% =	8.2%	
layer 7	% =	8.2%	
layer 8	% =	8.2%	
layer 9	% =		8.2%
layer 10	% =		8.2%
layer 11	% =		8.2%
layer 12	% =		8.2%
layer 13	% =		8.2%
layer 14	% =		8.2%

OK  
OK  
OK  
OK  
OK  
OK  
OK  
OK  
OK  
OK  
OK  
OK  
OK  
OK  
OK

**TOTAL LOSSES AT SERVICE LOADS**

Total Losses		at midspan	at endspan
layer 1	$\Delta f_{pT} =$	49.9 ksi	49.9 ksi
layer 2	$\Delta f_{pT} =$	49.9 ksi	49.9 ksi
layer 3	$\Delta f_{pT} =$	49.9 ksi	49.9 ksi
layer 4	$\Delta f_{pT} =$	49.9 ksi	49.9 ksi
layer 5	$\Delta f_{pT} =$	49.9 ksi	
layer 6	$\Delta f_{pT} =$	49.9 ksi	
layer 7	$\Delta f_{pT} =$	49.9 ksi	
layer 8	$\Delta f_{pT} =$	49.9 ksi	
layer 9	$\Delta f_{pT} =$		49.9 ksi
layer 10	$\Delta f_{pT} =$		49.9 ksi
layer 11	$\Delta f_{pT} =$		49.9 ksi
layer 12	$\Delta f_{pT} =$		49.9 ksi
layer 13	$\Delta f_{pT} =$		49.9 ksi
layer 14	$\Delta f_{pT} =$		49.9 ksi

Stress in tendon after all losses =  $f_{pr} - \Delta f_{pt}$

		at midspan	at endspan
layer 1	$f_{pe} =$	157.7 ksi	157.7 ksi
layer 2	$f_{pe} =$	157.7 ksi	157.7 ksi
layer 3	$f_{pe} =$	157.7 ksi	157.7 ksi
layer 4	$f_{pe} =$	157.7 ksi	157.7 ksi
layer 5	$f_{pe} =$	157.7 ksi	
layer 6	$f_{pe} =$	157.7 ksi	
layer 7	$f_{pe} =$	157.7 ksi	
layer 8	$f_{pe} =$	157.7 ksi	
layer 9	$f_{pe} =$		157.7 ksi
layer 10	$f_{pe} =$		157.7 ksi
layer 11	$f_{pe} =$		157.7 ksi
layer 12	$f_{pe} =$		157.7 ksi
layer 13	$f_{pe} =$		157.7 ksi
layer 14	$f_{pe} =$		157.7 ksi

check prestressing stress limit at service limit state:  $f_{pe} \leq 0.8 f_{py}$

layer 1	=	199.7 ksi
layer 2	=	199.7 ksi
layer 3	=	199.7 ksi
layer 4	=	199.7 ksi
layer 5	=	199.7 ksi
layer 6	=	199.7 ksi
layer 7	=	199.7 ksi
layer 8	=	199.7 ksi
layer 9	=	199.7 ksi
layer 10	=	199.7 ksi
layer 11	=	199.7 ksi
layer 12	=	199.7 ksi
layer 13	=	199.7 ksi
layer 14	=	199.7 ksi

OK  
OK  
OK  
OK  
OK  
OK  
OK  
OK  
OK  
OK  
OK  
OK  
OK  
OK

force per strand =  $f_{pe} \cdot \text{strand area}$

		at midspan	at endspan
layer 1	=	24.1 kips	24.1 kips
layer 2	=	24.1 kips	24.1 kips
layer 3	=	24.1 kips	24.1 kips
layer 4	=	24.1 kips	24.1 kips
layer 5	=	24.1 kips	
layer 6	=	24.1 kips	
layer 7	=	24.1 kips	
layer 8	=	24.1 kips	
layer 9	=		24.1 kips
layer 10	=		24.1 kips
layer 11	=		24.1 kips
layer 12	=		24.1 kips
layer 13	=		24.1 kips
layer 14	=		24.1 kips

		at midspan	at endspan
Total prestressing force after all losses	$P_{pe} =$	1061.6 kips	1061.6 kips
Final losses, % = $(\Delta f_{pT})/(f_{pi})$			
layer 1	% =	24.0%	24.0%
layer 2	% =	24.0%	24.0%
layer 3	% =	24.0%	24.0%
layer 4	% =	24.0%	24.0%
layer 5	% =	24.0%	
layer 6	% =	24.0%	
layer 7	% =	24.0%	
layer 8	% =	24.0%	
layer 9	% =		24.0%
layer 10	% =		24.0%
layer 11	% =		24.0%
layer 12	% =		24.0%
layer 13	% =		24.0%
layer 14	% =		24.0%
Average final losses, %	% =	24.0%	24.0%

### Stresses at Transfer

#### STRESS LIMITS FOR CONCRETE

Compression = $0.6f_{ci}$	$f_{ci} =$	3.300 ksi
Tension		
without bonded reinforcement = $-0.0948\sqrt{f_{ci}} \leq -0.2$	=	-0.200 ksi
with bonded auxiliary reinforcement = $-0.22\sqrt{f_{ci}}$	=	-0.016 ksi

#### STRESSES AT TRANSFER LENGTH SECTION

Transfer Length = $60 \times (\text{strand diameter})$	=	2.5 ft	} Calcs for eccentricity (see 9.6.7.2)
Bending moment at transfer length	$M_g =$	116.4 ft-kips	
center of 12 strands to top fiber of beam at the end	=	7.00 in	
center of 12 strands to bottom fiber of beam at the harp point	=	11.00 in	
center of 12 strands and top fiber of beam at transfer length	=	10.78 in	
center of gravity of 32 strands and bottom fiber of beam	=	3.88 in	
center of gravity of all strands and the bottom fiber of beam at transfer length	=	19.51 in	
center of gravity of all strands and the bottom fiber of beam at the end	=	20.55 in	
Eccentricity of the strand group at transfer length:	$e_{11} =$	17.09 in	}
Eccentricity at end of beam:	$e =$	16.05 in	

$$f_t = \frac{P_i}{A} - \frac{P_i e}{S_t} + \frac{M_g}{S_t}$$

$$f_b = \frac{P_i}{A} + \frac{P_i e}{S_b} - \frac{M_g}{S_b}$$

		at midspan	at endspan	
Top stress at top fiber of beam	$f_t =$	0.342 ksi	0.342 ksi	OK
Bottom stress at bottom fiber of the beam	$f_b =$	3.021 ksi	3.021 ksi	OK

#### STRESSES AT HARP POINT

Bending moment due to beam weight at 0.3L	$M_g =$	1188.0 ft-kips		
Top stress at top fiber of beam	$f_t =$	0.035 ksi	0.035 ksi	OK
Bottom stress at bottom fiber of the beam	$f_b =$	3.300 ksi	3.300 ksi	OK

#### STRESSES AT MIDSPAN

Bending moment due to beam weight at 0.5L	$M_g =$	1414.3 ft-kips		
Top stress at top fiber of beam	$f_t =$	0.220 ksi	0.211 ksi	OK
Bottom stress at bottom fiber of the beam	$f_b =$	3.144 ksi	3.189 ksi	OK

### HOLD-DOWN FORCES

assume stress in strand before losses =  $0.8f_u$

layer 1	=	221.4 ksi
layer 2	=	221.4 ksi
layer 3	=	221.4 ksi
layer 4	=	221.4 ksi
layer 5	=	221.4 ksi
layer 6	=	221.4 ksi
layer 7	=	221.4 ksi
layer 8	=	221.4 ksi
layer 9	=	221.4 ksi
layer 10	=	221.4 ksi
layer 11	=	221.4 ksi
layer 12	=	221.4 ksi
layer 13	=	221.4 ksi
layer 14	=	221.4 ksi

prestress force per strand before any losses:

layer 1	=	33.9 kips
layer 2	=	33.9 kips
layer 3	=	33.9 kips
layer 4	=	33.9 kips
layer 5	=	33.9 kips
layer 6	=	33.9 kips
layer 7	=	33.9 kips
layer 8	=	33.9 kips
layer 9	=	33.9 kips
layer 10	=	33.9 kips
layer 11	=	33.9 kips
layer 12	=	33.9 kips
layer 13	=	33.9 kips
layer 14	=	33.9 kips
Harp Angle	$\psi$ =	7.2 °

Hold-down force/strand

layer 1	=	4.4 kips/strand
layer 2	=	4.4 kips/strand
layer 3	=	4.4 kips/strand
layer 4	=	4.4 kips/strand
layer 5	=	4.4 kips/strand
layer 6	=	4.4 kips/strand
layer 7	=	4.4 kips/strand
layer 8	=	4.4 kips/strand
layer 9	=	4.4 kips/strand
layer 10	=	4.4 kips/strand
layer 11	=	4.4 kips/strand
layer 12	=	4.4 kips/strand
layer 13	=	4.4 kips/strand
layer 14	=	4.4 kips/strand
Total hold-down force	=	53.39 kips

### Stresses at Service Loads

#### STRESS LIMITS FOR CONCRETE

##### Compression:

Due to permanent loads for load combination Service I

for the precast beam	=	3.150 ksi
for deck	=	1.607 ksi

Due to permanent and transient loads for load combination Service I

for the precast beam	=	4.200 ksi
for deck	=	2.142 ksi

##### Tension:

Load Combination Service III

for the precast beam	=	-0.016 ksi
----------------------	---	------------

STRESSES AT MIDSPAN			
Compression stresses at top fiber of beam		at midspan	at endspan
$f_c = \frac{P}{A} - \frac{P_{pe}}{S_t} + \frac{(M_D + M_L)}{S_t} + \frac{(M_{ws} + M_b)}{S_{te}}$			
Due to permanent loads	$f_{ig} =$	2.042 ksi	2.042 ksi
$f_{ic} = \frac{P}{A} - \frac{P_{pe}}{S_t} + \frac{(M_D + M_L)}{S_t} + \frac{(M_{ws} + M_b)}{S_{te}} + \frac{(M_{LL+I})}{S_{te}}$			
Due to permanent loads and transient loads	$f_{ic} =$	2.465 ksi	2.465 ksi
Compression stresses at top fiber of deck		at midspan	at endspan
$f_{tc} = \frac{(M_{ws} + M_b)}{S_{te}}$			
Due to permanent loads	$f_{tc} =$	0.042 ksi	0.042 ksi
$f_{tc} = \frac{(M_{ws} + M_b + M_{LL+I})}{S_{te}}$			
Due to permanent loads and transient loads	$f_{tc} =$	0.478 ksi	0.478 ksi
Tension stresses at top fiber of deck		at midspan	at endspan
$f_{tr} = \frac{P_{pe}}{A} + \frac{P_{pe}}{S_b} - \frac{(M_D + M_L)}{S_b} - \frac{(M_{ws} + M_b + 0.5 * M_{LL+I})}{S_{te}}$			
Load Combination Service III	$f_b =$	-0.399 ksi	-0.399 ksi

OK  
OK  
OK  
OK  
OK

**Strength Limit State**

POSITIVE MOMENT SECTION		
$M_u = 1.25DC + 1.5DW + 1.75(LL+IM)$	$M_u =$	8381.5 ft-kips
effective length factor for compression members		
layer 1	k =	0.28
layer 2	k =	0.28
layer 3	k =	0.28
layer 4	k =	0.28
layer 5	k =	0.28
layer 6	k =	0.28
layer 7	k =	0.28
layer 8	k =	0.28
layer 9	k =	0.28
layer 10	k =	0.28
layer 11	k =	0.28
layer 12	k =	0.28
layer 13	k =	0.28
layer 14	k =	0.28
	c =	6.4 ft-kips
average stress in prestressing steel		
layer 1	$f_{ps} =$	270.2 ksi
layer 2	$f_{ps} =$	270.2 ksi
layer 3	$f_{ps} =$	270.2 ksi
layer 4	$f_{ps} =$	270.2 ksi
layer 5	$f_{ps} =$	270.2 ksi
layer 6	$f_{ps} =$	270.2 ksi
layer 7	$f_{ps} =$	270.2 ksi
layer 8	$f_{ps} =$	270.2 ksi
layer 9	$f_{ps} =$	270.2 ksi
layer 10	$f_{ps} =$	270.2 ksi
layer 11	$f_{ps} =$	270.2 ksi
layer 12	$f_{ps} =$	270.2 ksi
layer 13	$f_{ps} =$	270.2 ksi
layer 14	$f_{ps} =$	270.2 ksi
nominal flexure resistance		
$M_r = \Phi M_n, \Phi = 1.00$	a =	5.42 in
	$\Phi M_n =$	10835.1 ft-kips
NEGATIVE MOMENT SECTION		
$M_u = 1.25DC + 1.5DW + 1.75(LL+IM)$	$M_u =$	-4837.2 ft-kips
	a =	0.19 in
	$\Phi M_n =$	5101.2 ft-kips

OK  
OK





### Shear Design

CRITICAL SECTION AT 0.59			
$V_u = 1.25DC + 1.5DW + 1.75(LL+IM)$	$V_u =$	405.0 kips	
$M_u = 1.25DC + 1.5DW + 1.75(LL+IM)$	$M_u =$	-2684.4 ft-kips	
or			
$V_u = 1.25DC + 1.5DW + 1.75(LL+IM)$	$V_u =$	364.8 kips	
$M_u = 1.25DC + 1.5DW + 1.75(LL+IM)$	$M_u =$	-2877.0 ft-kips	
max shear	$V_u =$	405.0 kips	
max moment	$M_u =$	2877.0 ft-kips	
Shear depth	$d_v =$	73.19 in	
Applied factored normal force at the section	$N_u =$	0	
Angle of diagonal compressive stresses	$\theta =$	36.00 °	

### STRAIN IN FLEXURAL TENSION REINFORCEMENT

$$\epsilon_x = \frac{M_u + 0.5N_u + 0.5V_u \cot \theta - A_{ps} f_{ps}}{Z_x A_s + Z_y A_{ps}} \leq 0.002$$

		at midspan	at endspan
resultant compressive stress at centroid	$f_{pc} =$	1.006 ksi	1.006 ksi
effective stress in prestressing strand after all losses			
layer 1	$f_{po} =$	162.8 ksi	162.8 ksi
layer 2	$f_{po} =$	162.8 ksi	162.8 ksi
layer 3	$f_{po} =$	162.8 ksi	162.8 ksi
layer 4	$f_{po} =$	162.8 ksi	162.8 ksi
layer 5	$f_{po} =$	162.8 ksi	
layer 6	$f_{po} =$	162.8 ksi	
layer 7	$f_{po} =$	162.8 ksi	
layer 8	$f_{po} =$	162.8 ksi	
layer 9	$f_{po} =$		162.8 ksi
layer 10	$f_{po} =$		162.8 ksi
layer 11	$f_{po} =$		162.8 ksi
layer 12	$f_{po} =$		162.8 ksi
layer 13	$f_{po} =$		162.8 ksi
layer 14	$f_{po} =$		162.8 ksi
strain in flexural tension		at midspan	at endspan
layer 1	$\epsilon_x =$	0.002000	0.002000
layer 2	$\epsilon_x =$	0.002000	0.002000
layer 3	$\epsilon_x =$	0.002000	0.002000
layer 4	$\epsilon_x =$	0.002000	0.002000
layer 5	$\epsilon_x =$	0.002000	
layer 6	$\epsilon_x =$	0.002000	
layer 7	$\epsilon_x =$	0.002000	
layer 8	$\epsilon_x =$	0.002000	
layer 9	$\epsilon_x =$		0.002000
layer 10	$\epsilon_x =$		0.002000
layer 11	$\epsilon_x =$		0.002000
layer 12	$\epsilon_x =$		0.002000
layer 13	$\epsilon_x =$		0.002000
layer 14	$\epsilon_x =$		0.002000

### Deflection and Camber

		at midspan	at endspan
Deflection due to Prestressing Force at Transfer	$\Delta_p =$	3.97 in	3.97 in
Deflection due to Beam Self-Weight at Transfer	$\Delta_{q1} =$	-1.49 in	
Deflection due to Beam Self-Weight at Erection	$\Delta_{q2} =$	-1.44 in	
Deflection due to Haunch and Deck	$\Delta_s =$	-1.95 in	
Deflection due to total self weight	$\Delta_{sw} =$	0.59 in	
Total Deflection at transfer	$\Delta =$	2.48 in	2.48 in
Total Deflection at erection	$\Delta =$	4.49 in	4.49 in

### Deck Deflection (assuming 12" beam)

Deflection due to Deck Self-Weight	$\Delta_q =$	-1.1381 in
Live load deflection limit = span/800	$=$	0.18 in
Deflection due to live load and impact	$\Delta_L =$	-0.28 in

OK

**Location: Fire above Deck Between Girders**  
**Beam Design: 1/2" Strand**  
**Fire Exposure Status: 1-1/2 Hour**

(PCI Bridge Design Manual Section 9.6)



**Material Properties**

CAST-IN-PLACE SLAB		
Actual Thickness	$t_{as} =$	8.0 in
Wearing Surface	$=$	0.5 in
Structural thickness = Actual - Wearing Surface	$t_s =$	7.5 in
Compressive Strength	$f'_c =$	3.39 ksi
Unit Weight	$w_c =$	150.0 pcf
Stress factor of compression block	$\beta_1 =$	0.85

BEAMS: AASHTO-PCI, BT-72 BULB-TEE		
Strength at release	$f'_{ci} =$	5.5 ksi
Strength at 28 days	$f'_c =$	7 ksi
Unit Weight	$w_c =$	150.0 pcf
Overall Beam Length:		
@ end spans	$L =$	110 ft
@ center span	$L =$	119 ft
Design Spans:		
Non-composite beam @ end spans	$L =$	109 ft
Non-composite beam @ center span	$L =$	118 ft
Composite beam @ end spans	$L =$	110 ft
Composite beam @ center span	$L =$	120 ft
Beam Spacing	$S =$	12 ft



**PRESTRESSING STRANDS**

Diameter of single strand		d =	0.5 in
Area of single strand		A =	0.153 in <sup>2</sup>
Temperature of Layer			
	layer 1 (bottom)	T =	68.00 °F
	layer 2	T =	68.00 °F
	layer 3	T =	68.00 °F
	layer 4	T =	68.00 °F
	layer 5	T =	68.00 °F
	layer 6	T =	68.00 °F
	layer 7	T =	68.00 °F
	layer 8	T =	68.00 °F
	layer 9	T =	68.00 °F
	layer 10	T =	68.00 °F
	layer 11	T =	68.00 °F
	layer 12	T =	68.00 °F
	layer 13	T =	68.00 °F
	layer 14	T =	68.00 °F
Ultimate Strength			
initial =	277 ksi		
	layer 1 (bottom)	f <sub>pu</sub> =	277 ksi
	layer 2	f <sub>pu</sub> =	277 ksi
	layer 3	f <sub>pu</sub> =	277 ksi
	layer 4	f <sub>pu</sub> =	277 ksi
	layer 5	f <sub>pu</sub> =	277 ksi
	layer 6	f <sub>pu</sub> =	277 ksi
	layer 7	f <sub>pu</sub> =	277 ksi
	layer 8	f <sub>pu</sub> =	277 ksi
	layer 9	f <sub>pu</sub> =	277 ksi
	layer 10	f <sub>pu</sub> =	277 ksi
	layer 11	f <sub>pu</sub> =	277 ksi
	layer 12	f <sub>pu</sub> =	277 ksi
	layer 13	f <sub>pu</sub> =	277 ksi
	layer 14	f <sub>pu</sub> =	277 ksi
Yield Strength			
initial =	250 ksi		
	layer 1 (bottom)	f <sub>py</sub> =	250 ksi
	layer 2	f <sub>py</sub> =	250 ksi
	layer 3	f <sub>py</sub> =	250 ksi
	layer 4	f <sub>py</sub> =	250 ksi
	layer 5	f <sub>py</sub> =	250 ksi
	layer 6	f <sub>py</sub> =	250 ksi
	layer 7	f <sub>py</sub> =	250 ksi
	layer 8	f <sub>py</sub> =	250 ksi
	layer 9	f <sub>py</sub> =	250 ksi
	layer 10	f <sub>py</sub> =	250 ksi
	layer 11	f <sub>py</sub> =	250 ksi
	layer 12	f <sub>py</sub> =	250 ksi
	layer 13	f <sub>py</sub> =	250 ksi
	layer 14	f <sub>py</sub> =	250 ksi
<b>Stress Limits:</b>			
before transfer	≤ 0.75f <sub>pu</sub> (initial = 207.6)		
	layer 1 (bottom)	f <sub>pi</sub> =	207.6 ksi
	layer 2	f <sub>pi</sub> =	207.6 ksi
	layer 3	f <sub>pi</sub> =	207.6 ksi
	layer 4	f <sub>pi</sub> =	207.6 ksi
	layer 5	f <sub>pi</sub> =	207.6 ksi
	layer 6	f <sub>pi</sub> =	207.6 ksi
	layer 7	f <sub>pi</sub> =	207.6 ksi
	layer 8	f <sub>pi</sub> =	207.6 ksi
	layer 9	f <sub>pi</sub> =	207.6 ksi
	layer 10	f <sub>pi</sub> =	207.6 ksi
	layer 11	f <sub>pi</sub> =	207.6 ksi
	layer 12	f <sub>pi</sub> =	207.6 ksi
	layer 13	f <sub>pi</sub> =	207.6 ksi
	layer 14	f <sub>pi</sub> =	207.6 ksi

at service limit state (after all losses)  $\leq 0.80f_{py}$  (initial = 199.7)

layer 1 (bottom)	$f_{pe} =$	199.7 ksi
layer 2	$f_{pe} =$	199.7 ksi
layer 3	$f_{pe} =$	199.7 ksi
layer 4	$f_{pe} =$	199.7 ksi
layer 5	$f_{pe} =$	199.7 ksi
layer 6	$f_{pe} =$	199.7 ksi
layer 7	$f_{pe} =$	199.7 ksi
layer 8	$f_{pe} =$	199.7 ksi
layer 9	$f_{pe} =$	199.7 ksi
layer 10	$f_{pe} =$	199.7 ksi
layer 11	$f_{pe} =$	199.7 ksi
layer 12	$f_{pe} =$	199.7 ksi
layer 13	$f_{pe} =$	199.7 ksi
layer 14	$f_{pe} =$	199.7 ksi

Modulus of Elasticity

initial = 25982 ksi

layer 1 (bottom)	E =	25982.0 ksi
layer 2	E =	25982.0 ksi
layer 3	E =	25982.0 ksi
layer 4	E =	25982.0 ksi
layer 5	E =	25982.0 ksi
layer 6	E =	25982.0 ksi
layer 7	E =	25982.0 ksi
layer 8	E =	25982.0 ksi
layer 9	E =	25982.0 ksi
layer 10	E =	25982.0 ksi
layer 11	E =	25982.0 ksi
layer 12	E =	25982.0 ksi
layer 13	E =	25982.0 ksi
layer 14	E =	25982.0 ksi

#### MILD STEEL REINFORCING BARS AT ENDSpan

Yield Strength

Layer 1 (Bottom)	$f_y =$	60.0 ksi	68.00 °F
Layer 2 (Top)	$f_y =$	55.4 ksi	1010.00 °F

Modulus of Elasticity

E =	29000.0 ksi
-----	-------------

Layer 1 (Bottom)

Area of steel at midspan (effective flange)	$A_{sm} =$	2.79 in <sup>2</sup>
Area of steel at endspan (effective flange)	$A_{se} =$	2.48 in <sup>2</sup>
Area of temperature and shrinkage steel (12" width)	$A_s =$	0.31 in <sup>2</sup>

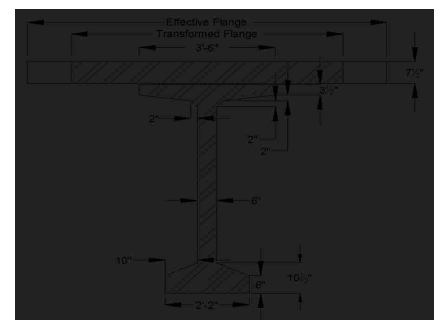
Layer 2 (Top)

Area of steel at midspan (effective flange)	$A_{sm} =$	12.6 in <sup>2</sup>
Area of steel at endspan (effective flange)	$A_{se} =$	12.4 in <sup>2</sup>
Area of temperature and shrinkage steel (12" width)	$A_s =$	0.2 in <sup>2</sup>

#### Cross-sectional Properties

##### NON-COMPOSITE BEAM

Area of cross-section of beam	A =	767.0 in <sup>2</sup>
Overall depth of beam	H =	72.0 in
Moment of Inertia	I =	539,947 in <sup>4</sup>
Distance from centroid to extreme bottom fiber	$y_b =$	36.6 in
Distance from centroid to extreme top fiber	$y_t =$	35.4 in
Section modulus for the extreme bottom fiber	$S_b =$	14915.0 in <sup>3</sup>
Section modulus for the extreme top fiber	$S_t =$	15421.0 in <sup>3</sup>
Weight	$W_t =$	799.0 plf
Modulus of Elasticity = $33000 \cdot (W_c^{1.5}) \cdot (\sqrt{f'_c})$		
cast-in-place concrete deck	$E_{cs} =$	3530 ksi
precast beam at release	$E_{ci} =$	4496 ksi
precast beam at service loads	$E_c =$	5072 ksi



### COMPOSITE BEAM

Effective Flange Width	$b_f =$	111.0 in	*min of three criteria
Modular Ratio = $E_{cs}/E_c$	$n =$	0.6959	
Transformed flange width	$=$	77.2 in	
Transformed flange area	$=$	579.3 in <sup>2</sup>	
Transformed haunch width	$=$	29.2 in	
Transformed haunch area	$=$	14.6 in <sup>2</sup>	

	Transformed Area	$y_b$	$Ay_b$	$A(y_{bc}-y_b)^2$	$I$	$I + A(y_{bc}-y_b)^2$
Beam	767.0 in <sup>2</sup>	36.60 in	28,072.2 in <sup>3</sup>	228,530 in <sup>4</sup>	539,947 in <sup>4</sup>	768,477 in <sup>4</sup>
Haunch	14.6 in <sup>2</sup>	72.25 in	1,055.9 in <sup>3</sup>	4,942 in <sup>4</sup>	0.33 in <sup>4</sup>	4,942 in <sup>4</sup>
Deck	579.3 in <sup>2</sup>	76.25 in	44,174.8 in <sup>3</sup>	290,397 in <sup>4</sup>	2,950 in <sup>4</sup>	293,346 in <sup>4</sup>
Total	1361.0 in <sup>2</sup>		73,302.9 in <sup>3</sup>			1,066,765 in <sup>4</sup>

Total area of Composite Section	$A_c =$	1361 in <sup>2</sup>
Overall Depth of the Composite Section	$h_c =$	80 in
Moment of Inertia	$I_c =$	1,066,765 in <sup>4</sup>
Distance from centroid to extreme <u>bottom</u> fiber of beam	$y_{bc} =$	53.86 in
Distance from centroid to extreme <u>top</u> fiber of beam	$y_{tg} =$	18.14 in
Distance from centroid to extreme <u>top</u> fiber of slab	$y_{tc} =$	26.14 in
Section modulus for the extreme <u>bottom</u> fiber of beam	$S_{bc} =$	19,805.8 in <sup>3</sup>
Section modulus for the extreme <u>top</u> fiber of beam	$S_{tg} =$	58,811.6 in <sup>3</sup>
Section modulus for the extreme <u>top</u> fiber slab	$S_{tc} =$	58,645.5 in <sup>3</sup>

### DECK (as 12" beam)

Reinforcing per 12"		at midspan	at beams
Layer 1 (Bottom)	$A_s =$	0.3 in <sup>2</sup>	0.3 in <sup>2</sup>
Layer 2 (Top)	$A_s =$	0.2 in <sup>2</sup>	0.2 in <sup>2</sup>

Modulus of Elasticity = $33000 \cdot (W_c^{1.5}) \cdot (\sqrt{f'_c})$ cast-in-place concrete deck	$E_{cs} =$	3530 ksi
--	------------	----------

Moment of Inertia	$I_g =$	200 in <sup>4</sup>
Distance from centroid to extreme <u>bottom</u> fiber of deck	$y_b =$	2.86 in
Distance from centroid to extreme <u>top</u> fiber of deck	$y_t =$	5.14 in
Modulus of Rupture	$f_r =$	436.7 psi
Cracking Moment	$M_{CR} =$	2.5 ft-kips
Max negative moment at loading stage	$M_a =$	16.9 ft-kips
Cracking Moment of Inertia	$I_{cr} =$	87 in <sup>4</sup>
Effective Moment of Inertia	$I_e =$	87 in <sup>4</sup>
Effective Moment of Inertia for Continuous Beam	$I_e =$	87 in <sup>4</sup>

### Shear Forces and Bending Moments

#### DEAD LOADS

Beam self-weight	$w_{beam} =$	0.799 k/f
8 in. deck weight	$w_{deck} =$	1.200 k/f
1/2 in. haunch weight	$w_{haunch} =$	0.022 k/f

LRFD Specifications: Art. 4.6.2.2.1		
Width of Deck Constant		OK
Number of beams is not less than four $N_b =$	4	OK
Roadway part of the overhang, $d_o \leq 3.0$ ft, $d_o =$	1.5	OK
Curvature in plans is less than $4^\circ =$	0	OK
Cross-section of the bridge is consistent with one of the cross sections given by LRFD specs		OK

Barrier and wearing surface loads are equally distributed among the 4 beams

Barrier Wt	$W_t =$	0.150 k/f
Dead load of future wearing surface	$DW =$	0.263 k/f

**LIVE LOADS**

Fire truck live load front load (Point A)	$P_{live} =$	48.0 kips
Fire truck live load back load (Point B)	$P_{live} =$	22.0 kips
distance between two loads		19.2 ft
distance from nearest edge to point A	$x_a =$	59.0 ft
distance from nearest edge to point B	$x_b =$	39.8 ft
LRFD Specifications: Art. 4.6.2.2.1		
Width of Deck Constant		OK
Number of beams is not less than four $N_b =$	4	OK
Beams are parallel and approximately of the same stiffness		OK
Roadway part of the overhang, $d_o \leq 3.0$ ft, $d_e =$	1.5	OK
Curvature in plans is less than $4^\circ =$	0	OK

Barrier and wearing surface loads are equally distributed among the 4 beams

Bridge Type-- "k" (LRFD Table 4.6.2.2.1-1)

Number of design lanes = $w/12$	=	3 lanes
---------------------------------	---	---------

**Distribution Factor for Bending Moment:**

Beams spacing	$S =$	12.0 ft
Depth of concrete slab	$t_s =$	7.5 in
Beam Span	$L =$	120.0 ft
Number of Beams	$N_b =$	4
Modular ratio between beam & deck materials	$n =$	1.4370
Longitudinal stiffness parameter	$K_g =$	2,508,620.17 in <sup>4</sup>

at center span:		
$DFM = 0.75 + \left(\frac{S}{9.5}\right)^{0.6} + \left(\frac{S}{L}\right)^{0.2} + \left(\frac{K_g}{12 * L * t_s^3}\right)^{0.1}$		
DFM =		0.911 lanes/beam

0.905 Controls

one design lane loaded:		
$DFM = 0.75 + \left(\frac{S}{14}\right)^{0.4} * \left(\frac{S}{L}\right)^{0.3} * \left(\frac{K_g}{12 * L * t_s^3}\right)^{0.1}$		
DFM =		0.618 lanes/beam

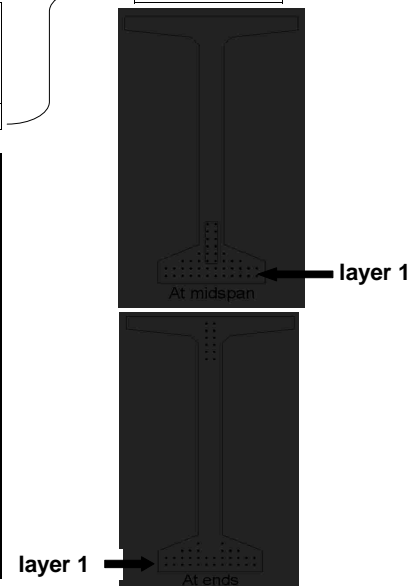
**Distribution Factor for Shear Force**

both end spans and center span:		
$DFV = 0.2 + \left(\frac{S}{12}\right) - \left(\frac{S}{35}\right)^2$		
DFV =		1.082 lanes/beam

1.082 Controls

one design lane loaded:		
$DFV = 0.36 + \left(\frac{S}{25}\right)$		
DFV =		0.840 lanes/beam

from bottom	At Midspan		At Ends	
	No. of	Distance from Bottom	No. of	Distance from Bottom
layer 1	12	2	12	2
layer 2	12	4	12	4
layer 3	8	6	6	6
layer 4	4	8	2	8
layer 5	2	10	-	-
layer 6	2	12	-	-
layer 7	2	14	-	-
layer 8	2	16	-	-
layer 9	-	-	2	60
layer 10	-	-	2	62
layer 11	-	-	2	64
layer 12	-	-	2	66
layer 13	-	-	2	68
layer 14	-	-	2	70
<b>Harped Strand Group (included in above totals)</b>				
layer 3	2	6		
layer 4	2	8		
layer 5	2	10		
layer 6	2	12		
layer 7	2	14		
layer 8	2	16		



distance from the center of gravity of strands to the bottom fiber of the beam = 7% of the beam depth  
strand eccentricity at midspan =  $(y_b - y_{bs})$

$y_{bs} =$	5.82 in
$e_c =$	30.78 in

**Prestress Losses**

**ELASTIC SHORTENING**

assumed loss	=	9.00%
--------------	---	-------

Force per strand at transfer		
layer 1	=	28.9 kips
layer 2	=	28.9 kips
layer 3	=	28.9 kips
layer 4	=	28.9 kips
layer 5	=	28.9 kips
layer 6	=	28.9 kips
layer 7	=	28.9 kips
layer 8	=	28.9 kips
layer 9	=	28.9 kips
layer 10	=	28.9 kips
layer 11	=	28.9 kips
layer 12	=	28.9 kips
layer 13	=	28.9 kips
layer 14	=	28.9 kips

		<b>at midspan</b>	<b>at endspan</b>
Total prestressing force at release	$P_i =$	1271.6 kips	1271.6 kips
Sum of concrete stresses at the center of gravity of prestressing tendons due to prestressing force at transfer and the self-weight of the member at sections of maximum moment	$f_{cgp} =$	2.938 ksi	2.938 ksi

Loss due to shortening			
		<b>at midspan</b>	<b>at endspan</b>
layer 1	$\Delta f_{pES} =$	17.0 ksi	17.0 ksi
layer 2	$\Delta f_{pES} =$	17.0 ksi	17.0 ksi
layer 3	$\Delta f_{pES} =$	17.0 ksi	17.0 ksi
layer 4	$\Delta f_{pES} =$	17.0 ksi	17.0 ksi
layer 5	$\Delta f_{pES} =$	17.0 ksi	
layer 6	$\Delta f_{pES} =$	17.0 ksi	
layer 7	$\Delta f_{pES} =$	17.0 ksi	
layer 8	$\Delta f_{pES} =$	17.0 ksi	
layer 9	$\Delta f_{pES} =$		17.0 ksi
layer 10	$\Delta f_{pES} =$		17.0 ksi
layer 11	$\Delta f_{pES} =$		17.0 ksi
layer 12	$\Delta f_{pES} =$		17.0 ksi
layer 13	$\Delta f_{pES} =$		17.0 ksi
layer 14	$\Delta f_{pES} =$		17.0 ksi

**SHRINKAGE**

Shrinkage = $(17 - 0.15 \times \text{Relative Humidity})$	$\Delta f_{pSR} =$	6.5 ksi	← assume relative humidity = 70%
---	--------------------	---------	----------------------------------

**CREEP OF CONCRETE**

Change of stresses at center of gravity of prestressing due to permanent loads except the loads acting at time of applying prestressing force, calculated at the same section as $f_{cgp}$	$\Delta f_{cdp} =$	1.564 ksi	
		<b>at midspan</b>	<b>at endspan</b>
loss due to creep	$\Delta f_{pCR} =$	24.3 ksi	24.3 ksi

**RELAXATION OF PRESTRESSING STRANDS**

loss due to relaxation after transfer		at midspan	at endspan
layer 1	$\Delta f_{pR2} =$	2.1 ksi	2.1 ksi
layer 2	$\Delta f_{pR2} =$	2.1 ksi	2.1 ksi
layer 3	$\Delta f_{pR2} =$	2.1 ksi	2.1 ksi
layer 4	$\Delta f_{pR2} =$	2.1 ksi	2.1 ksi
layer 5	$\Delta f_{pR2} =$	2.1 ksi	
layer 6	$\Delta f_{pR2} =$	2.1 ksi	
layer 7	$\Delta f_{pR2} =$	2.1 ksi	
layer 8	$\Delta f_{pR2} =$	2.1 ksi	
layer 9	$\Delta f_{pR2} =$		2.1 ksi
layer 10	$\Delta f_{pR2} =$		2.1 ksi
layer 11	$\Delta f_{pR2} =$		2.1 ksi
layer 12	$\Delta f_{pR2} =$		2.1 ksi
layer 13	$\Delta f_{pR2} =$		2.1 ksi
layer 14	$\Delta f_{pR2} =$		2.1 ksi

**TOTAL LOSSES AT TRANSFER**

total loss  $\Delta f_{pES} = \Delta f_{pi}$

stress in tendons after transfer  $f_{pt} = f_{pi} - \Delta f_{pi}$

		at midspan	at endspan
layer 1	$f_{pt} =$	190.6 ksi	190.6 ksi
layer 2	$f_{pt} =$	190.6 ksi	190.6 ksi
layer 3	$f_{pt} =$	190.6 ksi	190.6 ksi
layer 4	$f_{pt} =$	190.6 ksi	190.6 ksi
layer 5	$f_{pt} =$	190.6 ksi	
layer 6	$f_{pt} =$	190.6 ksi	
layer 7	$f_{pt} =$	190.6 ksi	
layer 8	$f_{pt} =$	190.6 ksi	
layer 9	$f_{pt} =$		190.6 ksi
layer 10	$f_{pt} =$		190.6 ksi
layer 11	$f_{pt} =$		190.6 ksi
layer 12	$f_{pt} =$		190.6 ksi
layer 13	$f_{pt} =$		190.6 ksi
layer 14	$f_{pt} =$		190.6 ksi

force per strand =  $f_{pt} \cdot \text{strand area}$

		at midspan	at endspan
layer 1	=	29.2 kips	29.2 kips
layer 2	=	29.2 kips	29.2 kips
layer 3	=	29.2 kips	29.2 kips
layer 4	=	29.2 kips	29.2 kips
layer 5	=	29.2 kips	
layer 6	=	29.2 kips	
layer 7	=	29.2 kips	
layer 8	=	29.2 kips	
layer 9	=		29.2 kips
layer 10	=		29.2 kips
layer 11	=		29.2 kips
layer 12	=		29.2 kips
layer 13	=		29.2 kips
layer 14	=		29.2 kips
Total prestressing force after transfer	$P_i =$	1284.8 kips	1284.8 kips

Initial loss =  $(\Delta f_{pi}) / (f_{pi})$

		at midspan	at endspan
layer 1	% =	8.2%	8.2%
layer 2	% =	8.2%	8.2%
layer 3	% =	8.2%	8.2%
layer 4	% =	8.2%	8.2%
layer 5	% =	8.2%	
layer 6	% =	8.2%	
layer 7	% =	8.2%	
layer 8	% =	8.2%	
layer 9	% =		8.2%
layer 10	% =		8.2%
layer 11	% =		8.2%
layer 12	% =		8.2%
layer 13	% =		8.2%
layer 14	% =		8.2%

OK  
OK  
OK  
OK  
OK  
OK  
OK  
OK  
OK  
OK  
OK  
OK  
OK  
OK  
OK



**TOTAL LOSSES AT SERVICE LOADS**

Total Losses		at midspan	at endspan
layer 1	$\Delta f_{pT} =$	49.9 ksi	49.9 ksi
layer 2	$\Delta f_{pT} =$	49.9 ksi	49.9 ksi
layer 3	$\Delta f_{pT} =$	49.9 ksi	49.9 ksi
layer 4	$\Delta f_{pT} =$	49.9 ksi	49.9 ksi
layer 5	$\Delta f_{pT} =$	49.9 ksi	
layer 6	$\Delta f_{pT} =$	49.9 ksi	
layer 7	$\Delta f_{pT} =$	49.9 ksi	
layer 8	$\Delta f_{pT} =$	49.9 ksi	
layer 9	$\Delta f_{pT} =$		49.9 ksi
layer 10	$\Delta f_{pT} =$		49.9 ksi
layer 11	$\Delta f_{pT} =$		49.9 ksi
layer 12	$\Delta f_{pT} =$		49.9 ksi
layer 13	$\Delta f_{pT} =$		49.9 ksi
layer 14	$\Delta f_{pT} =$		49.9 ksi
Stress in tendon after all losses = $f_{pr} - \Delta f_{pt}$		at midspan	at endspan
layer 1	$f_{pe} =$	157.7 ksi	157.7 ksi
layer 2	$f_{pe} =$	157.7 ksi	157.7 ksi
layer 3	$f_{pe} =$	157.7 ksi	157.7 ksi
layer 4	$f_{pe} =$	157.7 ksi	157.7 ksi
layer 5	$f_{pe} =$	157.7 ksi	
layer 6	$f_{pe} =$	157.7 ksi	
layer 7	$f_{pe} =$	157.7 ksi	
layer 8	$f_{pe} =$	157.7 ksi	
layer 9	$f_{pe} =$		157.7 ksi
layer 10	$f_{pe} =$		157.7 ksi
layer 11	$f_{pe} =$		157.7 ksi
layer 12	$f_{pe} =$		157.7 ksi
layer 13	$f_{pe} =$		157.7 ksi
layer 14	$f_{pe} =$		157.7 ksi
check prestressing stress limit at service limit state: $f_{pe} \leq 0.8 * f_{py}$			
layer 1	=	199.7 ksi	
layer 2	=	199.7 ksi	
layer 3	=	199.7 ksi	
layer 4	=	199.7 ksi	
layer 5	=	199.7 ksi	
layer 6	=	199.7 ksi	
layer 7	=	199.7 ksi	
layer 8	=	199.7 ksi	
layer 9	=	199.7 ksi	
layer 10	=	199.7 ksi	
layer 11	=	199.7 ksi	
layer 12	=	199.7 ksi	
layer 13	=	199.7 ksi	
layer 14	=	199.7 ksi	
force per strand = $f_{pe} * \text{strand area}$		at midspan	at endspan
layer 1	=	24.1 kips	24.1 kips
layer 2	=	24.1 kips	24.1 kips
layer 3	=	24.1 kips	24.1 kips
layer 4	=	24.1 kips	24.1 kips
layer 5	=	24.1 kips	
layer 6	=	24.1 kips	
layer 7	=	24.1 kips	
layer 8	=	24.1 kips	
layer 9	=		24.1 kips
layer 10	=		24.1 kips
layer 11	=		24.1 kips
layer 12	=		24.1 kips
layer 13	=		24.1 kips
layer 14	=		24.1 kips

OK  
OK  
OK  
OK  
OK  
OK  
OK  
OK  
OK  
OK  
OK  
OK  
OK  
OK  
OK

		at midspan	at endspan
Total prestressing force after all losses	$P_{pe} =$	1061.6 kips	1061.6 kips
Final losses, % = $(\Delta f_{pT})/(f_{pi})$			
layer 1	% =	24.0%	24.0%
layer 2	% =	24.0%	24.0%
layer 3	% =	24.0%	24.0%
layer 4	% =	24.0%	24.0%
layer 5	% =	24.0%	
layer 6	% =	24.0%	
layer 7	% =	24.0%	
layer 8	% =	24.0%	
layer 9	% =		24.0%
layer 10	% =		24.0%
layer 11	% =		24.0%
layer 12	% =		24.0%
layer 13	% =		24.0%
layer 14	% =		24.0%
Average final losses, %	% =	24.0%	24.0%

### Stresses at Transfer

#### STRESS LIMITS FOR CONCRETE

Compression = $0.6f_{ci}$	$f_{ci} =$	3.300 ksi
Tension		
without bonded reinforcement = $-0.0948\sqrt{f_{ci}} \leq -0.2$	$=$	-0.200 ksi
with bonded auxiliary reinforcement = $-0.22\sqrt{f_{ci}}$	$=$	-0.016 ksi

#### STRESSES AT TRANSFER LENGTH SECTION

Transfer Length = $60 \times (\text{strand diameter})$	$=$	2.5 ft	} Calcs for eccentricity (see 9.6.7.2)
Bending moment at transfer length	$M_g =$	116.4 ft-kips	
center of 12 strands to top fiber of beam at the end	$=$	7.00 in	
center of 12 strands to bottom fiber of beam at the harp point	$=$	11.00 in	
center of 12 strands and top fiber of beam at transfer length	$=$	10.78 in	
center of gravity of 32 strands and bottom fiber of beam	$=$	3.88 in	
center of gravity of all strands and the bottom fiber of beam at transfer length	$=$	19.51 in	
center of gravity of all strands and the bottom fiber of beam at the end	$=$	20.55 in	
Eccentricity of the strand group at transfer length:	$e_{11} =$	17.09 in	}
Eccentricity at end of beam:	$e =$	16.05 in	

$$f_t = \frac{P_i}{A} - \frac{P_i e}{S_t} + \frac{M_g}{S_t}$$

$$f_b = \frac{P_i}{A} + \frac{P_i e}{S_b} - \frac{M_g}{S_b}$$

		at midspan	at endspan	
Top stress at top fiber of beam	$f_t =$	0.342 ksi	0.342 ksi	OK
Bottom stress at bottom fiber of the beam	$f_b =$	3.021 ksi	3.021 ksi	OK

#### STRESSES AT HARP POINT

Bending moment due to beam weight at 0.3L	$M_g =$	1188.0 ft-kips		
Top stress at top fiber of beam	$f_t =$	0.035 ksi	0.035 ksi	OK
Bottom stress at bottom fiber of the beam	$f_b =$	3.300 ksi	3.300 ksi	OK

#### STRESSES AT MIDSPAN

Bending moment due to beam weight at 0.5L	$M_g =$	1414.3 ft-kips		
Top stress at top fiber of beam	$f_t =$	0.220 ksi	0.211 ksi	OK
Bottom stress at bottom fiber of the beam	$f_b =$	3.144 ksi	3.189 ksi	OK

**HOLD-DOWN FORCES**assume stress in strand before losses =  $0.8f_u$ 

layer 1	=	221.4 ksi
layer 2	=	221.4 ksi
layer 3	=	221.4 ksi
layer 4	=	221.4 ksi
layer 5	=	221.4 ksi
layer 6	=	221.4 ksi
layer 7	=	221.4 ksi
layer 8	=	221.4 ksi
layer 9	=	221.4 ksi
layer 10	=	221.4 ksi
layer 11	=	221.4 ksi
layer 12	=	221.4 ksi
layer 13	=	221.4 ksi
layer 14	=	221.4 ksi

prestress force per strand before any losses:

layer 1	=	33.9 kips
layer 2	=	33.9 kips
layer 3	=	33.9 kips
layer 4	=	33.9 kips
layer 5	=	33.9 kips
layer 6	=	33.9 kips
layer 7	=	33.9 kips
layer 8	=	33.9 kips
layer 9	=	33.9 kips
layer 10	=	33.9 kips
layer 11	=	33.9 kips
layer 12	=	33.9 kips
layer 13	=	33.9 kips
layer 14	=	33.9 kips
Harp Angle	$\psi =$	7.2 °

Hold-down force/strand

layer 1	=	4.4 kips/strand
layer 2	=	4.4 kips/strand
layer 3	=	4.4 kips/strand
layer 4	=	4.4 kips/strand
layer 5	=	4.4 kips/strand
layer 6	=	4.4 kips/strand
layer 7	=	4.4 kips/strand
layer 8	=	4.4 kips/strand
layer 9	=	4.4 kips/strand
layer 10	=	4.4 kips/strand
layer 11	=	4.4 kips/strand
layer 12	=	4.4 kips/strand
layer 13	=	4.4 kips/strand
layer 14	=	4.4 kips/strand
Total hold-down force	=	53.39 kips

**Stresses at Service Loads****STRESS LIMITS FOR CONCRETE****Compression:**

Due to permanent loads for load combination Service I

for the precast beam	=	3.150 ksi
for deck	=	1.526 ksi

Due to permanent and transient loads for load combination Service I

for the precast beam	=	4.200 ksi
for deck	=	2.034 ksi

**Tension:**

Load Combination Service III

for the precast beam	=	-0.016 ksi
----------------------	---	------------

STRESSES AT MIDSPAN			
Compression stresses at top fiber of beam		at midspan	at endspan
$f_z = \frac{P_{ps}}{A} - \frac{P_{ps}e}{S_t} + \frac{(M_D + M_L)}{S_t} + \frac{(M_{ws} + M_D)}{S_{tz}}$			
Due to permanent loads	$f_{t0} =$	2.043 ksi	2.043 ksi
$f_{tz} = \frac{P_{ps}}{A} - \frac{P_{ps}e}{S_t} + \frac{(M_D + M_L)}{S_t} + \frac{(M_{ws} + M_D)}{S_{tz}} + \frac{(M_{LL+I})}{S_{tz}}$			
Due to permanent loads and transient loads	$f_{t0} =$	2.475 ksi	2.475 ksi
Compression stresses at top fiber of deck		at midspan	at endspan
$f_{tc} = \frac{(M_{ws} + M_D)}{S_{tc}}$			
Due to permanent loads	$f_{t0} =$	0.041 ksi	0.041 ksi
$f_{tz} = \frac{(M_{ws} + M_D + M_{LL+I})}{S_{tc}}$			
Due to permanent loads and transient loads	$f_{t0} =$	0.474 ksi	0.474 ksi
Tension stresses at top fiber of deck		at midspan	at endspan
$f_{tb} = \frac{P_{ps}}{A} + \frac{P_{ps}e}{S_b} - \frac{(M_D + M_L)}{S_b} - \frac{(M_{ws} + M_D + 0.9M_{LL+I})}{S_{bc}}$			
Load Combination Service III	$f_b =$	-0.402 ksi	-0.402 ksi

OK

OK

OK

OK

OK

**Strength Limit State**

POSITIVE MOMENT SECTION		
$M_u = 1.25DC + 1.5DW + 1.75(LL+IM)$	$M_u =$	8381.5 ft-kips
effective length factor for compression members		
layer 1	k =	0.28
layer 2	k =	0.28
layer 3	k =	0.28
layer 4	k =	0.28
layer 5	k =	0.28
layer 6	k =	0.28
layer 7	k =	0.28
layer 8	k =	0.28
layer 9	k =	0.28
layer 10	k =	0.28
layer 11	k =	0.28
layer 12	k =	0.28
layer 13	k =	0.28
layer 14	k =	0.28
	c =	6.7 ft-kips
average stress in prestressing steel		
layer 1	$f_{ps} =$	269.9 ksi
layer 2	$f_{ps} =$	269.9 ksi
layer 3	$f_{ps} =$	269.9 ksi
layer 4	$f_{ps} =$	269.9 ksi
layer 5	$f_{ps} =$	269.9 ksi
layer 6	$f_{ps} =$	269.9 ksi
layer 7	$f_{ps} =$	269.9 ksi
layer 8	$f_{ps} =$	269.9 ksi
layer 9	$f_{ps} =$	269.9 ksi
layer 10	$f_{ps} =$	269.9 ksi
layer 11	$f_{ps} =$	269.9 ksi
layer 12	$f_{ps} =$	269.9 ksi
layer 13	$f_{ps} =$	269.9 ksi
layer 14	$f_{ps} =$	269.9 ksi
nominal flexure resistance		
$M_r = \Phi M_n, \Phi = 1.00$	$\Phi M_n =$	10800.2 ft-kips
NEGATIVE MOMENT SECTION		
$M_u = 1.25DC + 1.5DW + 1.75(LL+IM)$	$M_u =$	-4837.2 ft-kips
	a =	0.19 in
	$\Phi M_n =$	4945.9 ft-kips

OK

OK

### Shear Design

CRITICAL SECTION AT 0.59			
$V_u = 1.25DC + 1.5DW + 1.75(LL + IM)$	$V_u =$	405.0 kips	
$M_u = 1.25DC + 1.5DW + 1.75(LL + IM)$	$M_u =$	-2684.4 ft-kips	
or			
$V_u = 1.25DC + 1.5DW + 1.75(LL + IM)$	$V_u =$	364.8 kips	
$M_u = 1.25DC + 1.5DW + 1.75(LL + IM)$	$M_u =$	-2877.0 ft-kips	
max shear	$V_u =$	405.0 kips	
max moment	$M_u =$	2877.0 ft-kips	
Shear depth	$d_v =$	73.19 in	
Applied factored normal force at the section	$N_u =$	0	
Angle of diagonal compressive stresses	$\theta =$	36.00 °	

### STRAIN IN FLEXURAL TENSION REINFORCEMENT

$$\epsilon_x = \frac{M_u + 0.5N_u + 0.5V_u \cot \theta - A_{ps} f_{ps}}{E_s A_s + E_s A_{ps}} \leq 0.002$$

		at midspan	at endspan
resultant compressive stress at centroid	$f_{pc} =$	1.011 ksi	1.011 ksi
effective stress in prestressing strand after all losses			
layer 1	$f_{po} =$	162.9 ksi	162.9 ksi
layer 2	$f_{po} =$	162.9 ksi	162.9 ksi
layer 3	$f_{po} =$	162.9 ksi	162.9 ksi
layer 4	$f_{po} =$	162.9 ksi	162.9 ksi
layer 5	$f_{po} =$	162.9 ksi	
layer 6	$f_{po} =$	162.9 ksi	
layer 7	$f_{po} =$	162.9 ksi	
layer 8	$f_{po} =$	162.9 ksi	
layer 9	$f_{po} =$		162.9 ksi
layer 10	$f_{po} =$		162.9 ksi
layer 11	$f_{po} =$		162.9 ksi
layer 12	$f_{po} =$		162.9 ksi
layer 13	$f_{po} =$		162.9 ksi
layer 14	$f_{po} =$		162.9 ksi
strain in flexural tension		at midspan	at endspan
layer 1	$\epsilon_x =$	0.002000	0.002000
layer 2	$\epsilon_x =$	0.002000	0.002000
layer 3	$\epsilon_x =$	0.002000	0.002000
layer 4	$\epsilon_x =$	0.002000	0.002000
layer 5	$\epsilon_x =$	0.002000	
layer 6	$\epsilon_x =$	0.002000	
layer 7	$\epsilon_x =$	0.002000	
layer 8	$\epsilon_x =$	0.002000	
layer 9	$\epsilon_x =$		0.002000
layer 10	$\epsilon_x =$		0.002000
layer 11	$\epsilon_x =$		0.002000
layer 12	$\epsilon_x =$		0.002000
layer 13	$\epsilon_x =$		0.002000
layer 14	$\epsilon_x =$		0.002000

### Deflection and Camber

		at midspan	at endspan
Deflection due to Prestressing Force at Transfer	$\Delta_p =$	3.97 in	3.97 in
Deflection due to Beam Self-Weight at Transfer	$\Delta_{q1} =$	-1.49 in	
Deflection due to Beam Self-Weight at Erection	$\Delta_{q2} =$	-1.44 in	
Deflection due to Haunch and Deck	$\Delta_s =$	-1.95 in	
Deflection due to total self weight	$\Delta_{sw} =$	0.59 in	
Total Deflection at transfer	$\Delta =$	2.48 in	2.48 in
Total Deflection at erection	$\Delta =$	4.49 in	4.49 in

### Deck Deflection (assuming 12" beam)

Deflection due to Deck Self-Weight	$\Delta_q =$	-1.1719 in
Live load deflection limit = span/800	$=$	0.18 in
Deflection due to live load and impact	$\Delta_L =$	-0.34 in

OK

**Location: Fire above Deck Between Girders**  
**Beam Design: 1/2" Strand**  
**Fire Exposure Status: 2 Hour**

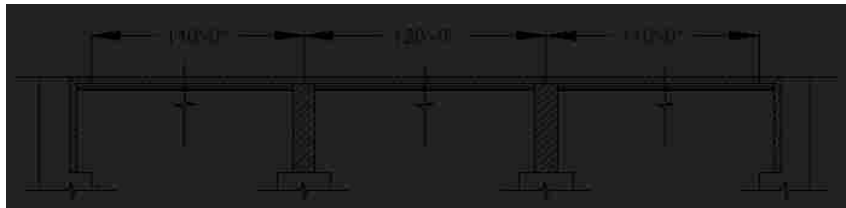
(PCI Bridge Design Manual Section 9.6)



**Material Properties**

CAST-IN-PLACE SLAB			
Actual Thickness	$t_{as} =$		8.0 in
Wearing Surface	$=$		0.5 in
Structural thickness = Actual - Wearing Surface	$t_s =$		7.5 in
Compressive Strength	$f'_c =$		3.25 ksi
Unit Weight	$w_c =$		150.0 pcf
Stress factor of compression block	$\beta_1 =$		0.85

BEAMS: AASHTO-PCI, BT-72 BULB-TEE			
Strength at release	$f'_{ci} =$		5.5 ksi
Strength at 28 days	$f'_c =$		7 ksi
Unit Weight	$w_c =$		150.0 pcf
Overall Beam Length:			
@ end spans	$L =$		110 ft
@ center span	$L =$		119 ft
Design Spans:			
Non-composite beam @ end spans	$L =$		109 ft
Non-composite beam @ center span	$L =$		118 ft
Composite beam @ end spans	$L =$		110 ft
Composite beam @ center span	$L =$		120 ft
Beam Spacing	$S =$		12 ft



**PRESTRESSING STRANDS**

Diameter of single strand		d =	0.5 in
Area of single strand		A =	0.153 in <sup>2</sup>
Temperature of Layer			
	layer 1 (bottom)	T =	68.00 °F
	layer 2	T =	68.00 °F
	layer 3	T =	68.00 °F
	layer 4	T =	68.00 °F
	layer 5	T =	68.00 °F
	layer 6	T =	68.00 °F
	layer 7	T =	68.00 °F
	layer 8	T =	68.00 °F
	layer 9	T =	68.00 °F
	layer 10	T =	68.00 °F
	layer 11	T =	68.00 °F
	layer 12	T =	68.00 °F
	layer 13	T =	68.00 °F
	layer 14	T =	68.00 °F
Ultimate Strength			
	initial = 277 ksi		
	layer 1 (bottom)	f <sub>pu</sub> =	277 ksi
	layer 2	f <sub>pu</sub> =	277 ksi
	layer 3	f <sub>pu</sub> =	277 ksi
	layer 4	f <sub>pu</sub> =	277 ksi
	layer 5	f <sub>pu</sub> =	277 ksi
	layer 6	f <sub>pu</sub> =	277 ksi
	layer 7	f <sub>pu</sub> =	277 ksi
	layer 8	f <sub>pu</sub> =	277 ksi
	layer 9	f <sub>pu</sub> =	277 ksi
	layer 10	f <sub>pu</sub> =	277 ksi
	layer 11	f <sub>pu</sub> =	277 ksi
	layer 12	f <sub>pu</sub> =	277 ksi
	layer 13	f <sub>pu</sub> =	277 ksi
	layer 14	f <sub>pu</sub> =	277 ksi
Yield Strength			
	initial = 250 ksi		
	layer 1 (bottom)	f <sub>py</sub> =	250 ksi
	layer 2	f <sub>py</sub> =	250 ksi
	layer 3	f <sub>py</sub> =	250 ksi
	layer 4	f <sub>py</sub> =	250 ksi
	layer 5	f <sub>py</sub> =	250 ksi
	layer 6	f <sub>py</sub> =	250 ksi
	layer 7	f <sub>py</sub> =	250 ksi
	layer 8	f <sub>py</sub> =	250 ksi
	layer 9	f <sub>py</sub> =	250 ksi
	layer 10	f <sub>py</sub> =	250 ksi
	layer 11	f <sub>py</sub> =	250 ksi
	layer 12	f <sub>py</sub> =	250 ksi
	layer 13	f <sub>py</sub> =	250 ksi
	layer 14	f <sub>py</sub> =	250 ksi
<b>Stress Limits:</b>			
	before transfer ≤ 0.75f <sub>pu</sub> (initial = 207.6)		
	layer 1 (bottom)	f <sub>pi</sub> =	207.6 ksi
	layer 2	f <sub>pi</sub> =	207.6 ksi
	layer 3	f <sub>pi</sub> =	207.6 ksi
	layer 4	f <sub>pi</sub> =	207.6 ksi
	layer 5	f <sub>pi</sub> =	207.6 ksi
	layer 6	f <sub>pi</sub> =	207.6 ksi
	layer 7	f <sub>pi</sub> =	207.6 ksi
	layer 8	f <sub>pi</sub> =	207.6 ksi
	layer 9	f <sub>pi</sub> =	207.6 ksi
	layer 10	f <sub>pi</sub> =	207.6 ksi
	layer 11	f <sub>pi</sub> =	207.6 ksi
	layer 12	f <sub>pi</sub> =	207.6 ksi
	layer 13	f <sub>pi</sub> =	207.6 ksi
	layer 14	f <sub>pi</sub> =	207.6 ksi

at service limit state (after all losses)  $\leq 0.80f_{py}$  (initial = 199.7)

layer 1 (bottom)	$f_{pe} =$	199.7 ksi
layer 2	$f_{pe} =$	199.7 ksi
layer 3	$f_{pe} =$	199.7 ksi
layer 4	$f_{pe} =$	199.7 ksi
layer 5	$f_{pe} =$	199.7 ksi
layer 6	$f_{pe} =$	199.7 ksi
layer 7	$f_{pe} =$	199.7 ksi
layer 8	$f_{pe} =$	199.7 ksi
layer 9	$f_{pe} =$	199.7 ksi
layer 10	$f_{pe} =$	199.7 ksi
layer 11	$f_{pe} =$	199.7 ksi
layer 12	$f_{pe} =$	199.7 ksi
layer 13	$f_{pe} =$	199.7 ksi
layer 14	$f_{pe} =$	199.7 ksi

Modulus of Elasticity

initial = 25982 ksi

layer 1 (bottom)	E =	25982.0 ksi
layer 2	E =	25982.0 ksi
layer 3	E =	25982.0 ksi
layer 4	E =	25982.0 ksi
layer 5	E =	25982.0 ksi
layer 6	E =	25982.0 ksi
layer 7	E =	25982.0 ksi
layer 8	E =	25982.0 ksi
layer 9	E =	25982.0 ksi
layer 10	E =	25982.0 ksi
layer 11	E =	25982.0 ksi
layer 12	E =	25982.0 ksi
layer 13	E =	25982.0 ksi
layer 14	E =	25982.0 ksi

#### MILD STEEL REINFORCING BARS AT ENDSpan

Yield Strength

Layer 1 (Bottom)	$f_y =$	60.0 ksi	68.00 °F
Layer 2 (Top)	$f_y =$	53.3 ksi	1120.00 °F

Modulus of Elasticity

E =	29000.0 ksi
-----	-------------

Layer 1 (Bottom)

Area of steel at midspan (effective flange)	$A_{sm} =$	2.79 in <sup>2</sup>
Area of steel at endspan (effective flange)	$A_{se} =$	2.48 in <sup>2</sup>
Area of temperature and shrinkage steel (12" width)	$A_s =$	0.31 in <sup>2</sup>

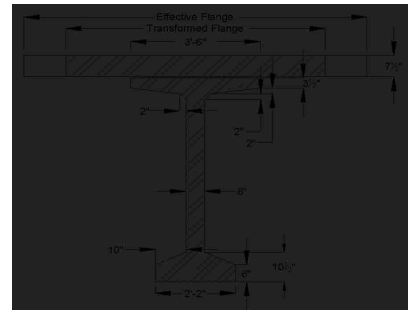
Layer 2 (Top)

Area of steel at midspan (effective flange)	$A_{sm} =$	12.6 in <sup>2</sup>
Area of steel at endspan (effective flange)	$A_{se} =$	12.4 in <sup>2</sup>
Area of temperature and shrinkage steel (12" width)	$A_s =$	0.2 in <sup>2</sup>

#### Cross-sectional Properties

##### NON-COMPOSITE BEAM

Area of cross-section of beam	A =	767.0 in <sup>2</sup>
Overall depth of beam	H =	72.0 in
Moment of Inertia	I =	539,947 in <sup>4</sup>
Distance from centroid to extreme <b>bottom</b> fiber	$y_b =$	36.6 in
Distance from centroid to extreme <b>top</b> fiber	$y_t =$	35.4 in
Section modulus for the extreme <b>bottom</b> fiber	$S_b =$	14915.0 in <sup>3</sup>
Section modulus for the extreme <b>top</b> fiber	$S_t =$	15421.0 in <sup>3</sup>
Weight	$W_t =$	799.0 plf
Modulus of Elasticity = $33000 \cdot (W_c^{1.5}) \cdot (\sqrt{f_c})$		
cast-in-place concrete deck	$E_{cs} =$	3456 ksi
precast beam at release	$E_{ci} =$	4496 ksi
precast beam at service loads	$E_c =$	5072 ksi





**COMPOSITE BEAM**

Effective Flange Width	$b_f =$	111.0 in	*min of three criteria
Modular Ratio = $E_{cs}/E_c$	$n =$	0.6814	
Transformed flange width	$=$	75.6 in	
Transformed flange area	$=$	567.3 in <sup>2</sup>	
Transformed haunch width	$=$	28.6 in	
Transformed haunch area	$=$	14.3 in <sup>2</sup>	

	Transformed Area	$y_b$	$Ay_b$	$A(y_{bc}-y_b)^2$	$I$	$I + A(y_{bc}-y_b)^2$
Beam	767.0 in <sup>2</sup>	36.60 in	28,072.2 in <sup>3</sup>	223,138 in <sup>4</sup>	539,947 in <sup>4</sup>	763,085 in <sup>4</sup>
Haunch	14.3 in <sup>2</sup>	72.25 in	1,033.8 in <sup>3</sup>	4,947 in <sup>4</sup>	0.33 in <sup>4</sup>	4,947 in <sup>4</sup>
Deck	567.3 in <sup>2</sup>	76.25 in	43,253.1 in <sup>3</sup>	289,564 in <sup>4</sup>	2,950 in <sup>4</sup>	292,514 in <sup>4</sup>
Total	1348.6 in <sup>2</sup>		72,359.1 in <sup>3</sup>			1,060,546 in <sup>4</sup>

Total area of Composite Section	$A_c =$	1349 in <sup>2</sup>
Overall Depth of the Composite Section	$h_c =$	80 in
Moment of Inertia	$I_c =$	1,060,546 in <sup>4</sup>
Distance from centroid to extreme <u>bottom</u> fiber of beam	$y_{bc} =$	53.66 in
Distance from centroid to extreme <u>top</u> fiber of beam	$y_{tb} =$	18.34 in
Distance from centroid to extreme <u>top</u> fiber of slab	$y_{tc} =$	26.34 in
Section modulus for the extreme <u>bottom</u> fiber of beam	$S_{bc} =$	19,765.5 in <sup>3</sup>
Section modulus for the extreme <u>top</u> fiber of beam	$S_{tb} =$	57,815.8 in <sup>3</sup>
Section modulus for the extreme <u>top</u> fiber slab	$S_{tc} =$	59,083.0 in <sup>3</sup>

**DECK (as 12" beam)**

Reinforcing per 12"		at midspan	at beams
Layer 1 (Bottom)	$A_{s1} =$	0.3 in <sup>2</sup>	0.3 in <sup>2</sup>
Layer 2 (Top)	$A_{s2} =$	0.2 in <sup>2</sup>	0.2 in <sup>2</sup>

Modulus of Elasticity = $33000 \cdot (W_c^{1.5}) \cdot (\sqrt{f'_c})$ cast-in-place concrete deck	$E_{cs} =$	3456 ksi
--	------------	----------

Moment of Inertia	$I_g =$	166 in <sup>4</sup>	
Distance from centroid to extreme <u>bottom</u> fiber of deck	$y_b =$	2.66 in	
Distance from centroid to extreme <u>top</u> fiber of deck	$y_t =$	5.34 in	
Modulus of Rupture	$f_r =$	427.6 psi	
Cracking Moment	$M_{CR} =$	2.2 ft-kips	1.1 ft-kips
Max negative moment at loading stage	$M_a =$	16.9 ft-kips	21.1 ft-kips
Cracking Moment of Inertia	$I_{cr} =$	87 in <sup>4</sup>	87 in <sup>4</sup>
Effective Moment of Inertia	$I_e =$	87 in <sup>4</sup>	87 in <sup>4</sup>
Effective Moment of Inertia for Continuous Beam	$I_e =$	87 in <sup>4</sup>	

**Shear Forces and Bending Moments**

**DEAD LOADS**

Beam self-weight	$W_{beam} =$	0.799 k/f
8 in. deck weight	$W_{deck} =$	1.200 k/f
1/2 in. haunch weight	$W_{haunch} =$	0.022 k/f

LRFD Specifications: Art. 4.6.2.2.1		
Width of Deck Constant		OK
Number of beams is not less than four $N_b =$	4	OK
Roadway part of the overhang, $d_o \leq 3.0$ ft, $d_o =$	1.5	OK
Curvature in plans is less than $4^\circ =$	0	OK
Cross-section of the bridge is consistent with one of the cross sections given by LRFD specs		OK

Barrier and wearing surface loads are equally distributed among the 4 beams

Barrier Wt	$W_t =$	0.150 k/f
Dead load of future wearing surface	$DW =$	0.263 k/f

**LIVE LOADS**

Fire truck live load front load (Point A)	$P_{live} =$	48.0 kips
Fire truck live load back load (Point B)	$P_{live} =$	22.0 kips
distance between two loads		19.2 ft
distance from nearest edge to point A	$x_a =$	59.0 ft
distance from nearest edge to point B	$x_b =$	39.8 ft
LRFD Specifications: Art. 4.6.2.2.1		
Width of Deck Constant		OK
Number of beams is not less than four $N_b =$	4	OK
Beams are parallel and approximately of the same stiffness		OK
Roadway part of the overhang, $d_o \leq 3.0$ ft, $d_o =$	1.5	OK
Curvature in plans is less than $4^\circ =$	0	OK

Barrier and wearing surface loads are equally distributed among the 4 beams

Bridge Type-- "k" (LRFD Table 4.6.2.2.1-1)

Number of design lanes = w/12	=	3 lanes
-------------------------------	---	---------

**Distribution Factor for Bending Moment:**

Beams spacing	$S =$	12.0 ft
Depth of concrete slab	$t_s =$	7.5 in
Beam Span	$L =$	120.0 ft
Number of Beams	$N_b =$	4
Modular ratio between beam & deck materials	$n =$	1.4676
Longitudinal stiffness parameter	$K_q =$	2,562,082.31 in <sup>4</sup>

at center span:		
$DFM = 0.75 \left[ \left( \frac{S}{9.5} \right)^{0.6} * \left( \frac{S}{L} \right)^{0.2} * \left( \frac{K_q}{12 * L * t_s^3} \right)^{0.1} \right]$		
DFM =		0.913 lanes/beam

0.905 Controls

one design lane loaded:		
$DFM = 0.75 + \left( \frac{S}{14} \right)^{0.4} * \left( \frac{S}{L} \right)^{0.3} * \left( \frac{K_q}{12 * L * t_s^3} \right)^{0.1}$		
DFM =		0.619 lanes/beam

**Distribution Factor for Shear Force**

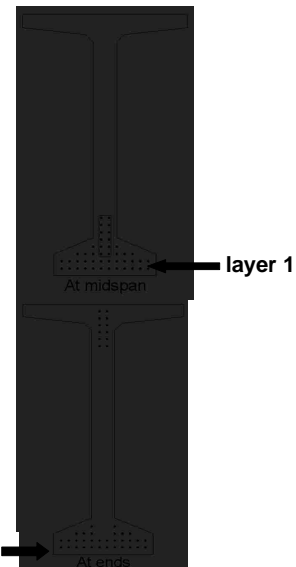
both end spans and center span:		
$DFV = 0.2 + \left( \frac{S}{12} \right) - \left( \frac{S}{35} \right)^2$		
DFV =		1.082 lanes/beam

1.082 Controls

one design lane loaded:		
$DFV = 0.36 + \left( \frac{S}{25} \right)$		
DFV =		0.840 lanes/beam

	At Midspan		At Ends	
from bottom	No. of	Distance from Bottom	No. of	Distance from Bottom
layer 1	12	2	12	2
layer 2	12	4	12	4
layer 3	8	6	6	6
layer 4	4	8	2	8
layer 5	2	10	-	-
layer 6	2	12	-	-
layer 7	2	14	-	-
layer 8	2	16	-	-
layer 9	-	-	2	60
layer 10	-	-	2	62
layer 11	-	-	2	64
layer 12	-	-	2	66
layer 13	-	-	2	68
layer 14	-	-	2	70
<b>Harped Strand Group (included in above totals)</b>				
layer 3	2	6		
layer 4	2	8		
layer 5	2	10		
layer 6	2	12		
layer 7	2	14		
layer 8	2	16		

layer 1



distance from the center of gravity of strands to the bottom fiber of the beam = 7% of the beam depth  
strand eccentricity at midspan =  $(y_b - y_{bs})$

$y_{bs} =$	5.82 in
$e_c =$	30.78 in

### Prestress Losses

#### ELASTIC SHORTENING

assumed loss	=	9.00%
Force per strand at transfer		
layer 1	=	28.9 kips
layer 2	=	28.9 kips
layer 3	=	28.9 kips
layer 4	=	28.9 kips
layer 5	=	28.9 kips
layer 6	=	28.9 kips
layer 7	=	28.9 kips
layer 8	=	28.9 kips
layer 9	=	28.9 kips
layer 10	=	28.9 kips
layer 11	=	28.9 kips
layer 12	=	28.9 kips
layer 13	=	28.9 kips
layer 14	=	28.9 kips
		<b>at midspan</b>
Total prestressing force at release	$P_i =$	1271.6 kips
		<b>at endspan</b>
Sum of concrete stresses at the center of gravity of prestressing tendons due to prestressing force at transfer and the self-weight of the member at sections of maximum moment	$f_{cgp} =$	2.938 ksi
		2.938 ksi
Loss due to shortening		<b>at midspan</b>
		<b>at endspan</b>
layer 1	$\Delta f_{pES} =$	17.0 ksi
layer 2	$\Delta f_{pES} =$	17.0 ksi
layer 3	$\Delta f_{pES} =$	17.0 ksi
layer 4	$\Delta f_{pES} =$	17.0 ksi
layer 5	$\Delta f_{pES} =$	17.0 ksi
layer 6	$\Delta f_{pES} =$	17.0 ksi
layer 7	$\Delta f_{pES} =$	17.0 ksi
layer 8	$\Delta f_{pES} =$	17.0 ksi
layer 9	$\Delta f_{pES} =$	17.0 ksi
layer 10	$\Delta f_{pES} =$	17.0 ksi
layer 11	$\Delta f_{pES} =$	17.0 ksi
layer 12	$\Delta f_{pES} =$	17.0 ksi
layer 13	$\Delta f_{pES} =$	17.0 ksi
layer 14	$\Delta f_{pES} =$	17.0 ksi

#### SHRINKAGE

Shrinkage =  $(17 - 0.15 \times \text{Relative Humidity})$   $\Delta f_{pSR} =$  6.5 ksi ← assume relative humidity = 70%

#### CREEP OF CONCRETE

Change of stresses at center of gravity of prestressing due to permanent loads except the loads acting at time of applying prestressing force, calculated at the same section as $f_{cgp}$	$\Delta f_{cgp} =$	1.564 ksi
		<b>at midspan</b>
		<b>at endspan</b>
loss due to creep	$\Delta f_{pCR} =$	24.3 ksi
		24.3 ksi

**RELAXATION OF PRESTRESSING STRANDS**

loss due to relaxation after transfer		at midspan	at endspan
layer 1	$\Delta f_{pR2} =$	2.1 ksi	2.1 ksi
layer 2	$\Delta f_{pR2} =$	2.1 ksi	2.1 ksi
layer 3	$\Delta f_{pR2} =$	2.1 ksi	2.1 ksi
layer 4	$\Delta f_{pR2} =$	2.1 ksi	2.1 ksi
layer 5	$\Delta f_{pR2} =$	2.1 ksi	
layer 6	$\Delta f_{pR2} =$	2.1 ksi	
layer 7	$\Delta f_{pR2} =$	2.1 ksi	
layer 8	$\Delta f_{pR2} =$	2.1 ksi	
layer 9	$\Delta f_{pR2} =$		2.1 ksi
layer 10	$\Delta f_{pR2} =$		2.1 ksi
layer 11	$\Delta f_{pR2} =$		2.1 ksi
layer 12	$\Delta f_{pR2} =$		2.1 ksi
layer 13	$\Delta f_{pR2} =$		2.1 ksi
layer 14	$\Delta f_{pR2} =$		2.1 ksi

**TOTAL LOSSES AT TRANSFER**

total loss  $\Delta f_{pES} = \Delta f_{pi}$

stress in tendons after transfer  $f_{pt} = f_{pi} - \Delta f_{pi}$

		at midspan	at endspan
layer 1	$f_{pt} =$	190.6 ksi	190.6 ksi
layer 2	$f_{pt} =$	190.6 ksi	190.6 ksi
layer 3	$f_{pt} =$	190.6 ksi	190.6 ksi
layer 4	$f_{pt} =$	190.6 ksi	190.6 ksi
layer 5	$f_{pt} =$	190.6 ksi	
layer 6	$f_{pt} =$	190.6 ksi	
layer 7	$f_{pt} =$	190.6 ksi	
layer 8	$f_{pt} =$	190.6 ksi	
layer 9	$f_{pt} =$		190.6 ksi
layer 10	$f_{pt} =$		190.6 ksi
layer 11	$f_{pt} =$		190.6 ksi
layer 12	$f_{pt} =$		190.6 ksi
layer 13	$f_{pt} =$		190.6 ksi
layer 14	$f_{pt} =$		190.6 ksi

force per strand =  $f_{pt} \times$  strand area

		at midspan	at endspan
layer 1	=	29.2 kips	29.2 kips
layer 2	=	29.2 kips	29.2 kips
layer 3	=	29.2 kips	29.2 kips
layer 4	=	29.2 kips	29.2 kips
layer 5	=	29.2 kips	
layer 6	=	29.2 kips	
layer 7	=	29.2 kips	
layer 8	=	29.2 kips	
layer 9	=		29.2 kips
layer 10	=		29.2 kips
layer 11	=		29.2 kips
layer 12	=		29.2 kips
layer 13	=		29.2 kips
layer 14	=		29.2 kips
Total prestressing force after transfer	$P_1 =$	1284.8 kips	1284.8 kips

Initial loss =  $(\Delta f_{pi}) / (f_{pi})$

		at midspan	at endspan
layer 1	% =	8.2%	8.2%
layer 2	% =	8.2%	8.2%
layer 3	% =	8.2%	8.2%
layer 4	% =	8.2%	8.2%
layer 5	% =	8.2%	
layer 6	% =	8.2%	
layer 7	% =	8.2%	
layer 8	% =	8.2%	
layer 9	% =		8.2%
layer 10	% =		8.2%
layer 11	% =		8.2%
layer 12	% =		8.2%
layer 13	% =		8.2%
layer 14	% =		8.2%

OK  
OK  
OK  
OK  
OK  
OK  
OK  
OK  
OK  
OK  
OK  
OK  
OK  
OK  
OK

**TOTAL LOSSES AT SERVICE LOADS**

Total Losses		at midspan	at endspan
layer 1	$\Delta f_{pT} =$	49.9 ksi	49.9 ksi
layer 2	$\Delta f_{pT} =$	49.9 ksi	49.9 ksi
layer 3	$\Delta f_{pT} =$	49.9 ksi	49.9 ksi
layer 4	$\Delta f_{pT} =$	49.9 ksi	49.9 ksi
layer 5	$\Delta f_{pT} =$	49.9 ksi	
layer 6	$\Delta f_{pT} =$	49.9 ksi	
layer 7	$\Delta f_{pT} =$	49.9 ksi	
layer 8	$\Delta f_{pT} =$	49.9 ksi	
layer 9	$\Delta f_{pT} =$		49.9 ksi
layer 10	$\Delta f_{pT} =$		49.9 ksi
layer 11	$\Delta f_{pT} =$		49.9 ksi
layer 12	$\Delta f_{pT} =$		49.9 ksi
layer 13	$\Delta f_{pT} =$		49.9 ksi
layer 14	$\Delta f_{pT} =$		49.9 ksi

Stress in tendon after all losses = $f_{pr} - \Delta f_{pt}$		at midspan	at endspan
layer 1	$f_{pe} =$	157.7 ksi	157.7 ksi
layer 2	$f_{pe} =$	157.7 ksi	157.7 ksi
layer 3	$f_{pe} =$	157.7 ksi	157.7 ksi
layer 4	$f_{pe} =$	157.7 ksi	157.7 ksi
layer 5	$f_{pe} =$	157.7 ksi	
layer 6	$f_{pe} =$	157.7 ksi	
layer 7	$f_{pe} =$	157.7 ksi	
layer 8	$f_{pe} =$	157.7 ksi	
layer 9	$f_{pe} =$		157.7 ksi
layer 10	$f_{pe} =$		157.7 ksi
layer 11	$f_{pe} =$		157.7 ksi
layer 12	$f_{pe} =$		157.7 ksi
layer 13	$f_{pe} =$		157.7 ksi
layer 14	$f_{pe} =$		157.7 ksi

check prestressing stress limit at service limit state:  $f_{pe} \leq 0.8 \cdot f_{py}$

layer 1	=	199.7 ksi	OK
layer 2	=	199.7 ksi	OK
layer 3	=	199.7 ksi	OK
layer 4	=	199.7 ksi	OK
layer 5	=	199.7 ksi	OK
layer 6	=	199.7 ksi	OK
layer 7	=	199.7 ksi	OK
layer 8	=	199.7 ksi	OK
layer 9	=	199.7 ksi	OK
layer 10	=	199.7 ksi	OK
layer 11	=	199.7 ksi	OK
layer 12	=	199.7 ksi	OK
layer 13	=	199.7 ksi	OK
layer 14	=	199.7 ksi	OK

force per strand =  $f_{pe} \cdot \text{strand area}$

		at midspan	at endspan
layer 1	=	24.1 kips	24.1 kips
layer 2	=	24.1 kips	24.1 kips
layer 3	=	24.1 kips	24.1 kips
layer 4	=	24.1 kips	24.1 kips
layer 5	=	24.1 kips	
layer 6	=	24.1 kips	
layer 7	=	24.1 kips	
layer 8	=	24.1 kips	
layer 9	=		24.1 kips
layer 10	=		24.1 kips
layer 11	=		24.1 kips
layer 12	=		24.1 kips
layer 13	=		24.1 kips
layer 14	=		24.1 kips

		at midspan	at endspan
Total prestressing force after all losses	$P_{pe} =$	1061.6 kips	1061.6 kips
Final losses, % = $(\Delta f_{pT})/f_{pi}$			
layer 1	% =	24.0%	24.0%
layer 2	% =	24.0%	24.0%
layer 3	% =	24.0%	24.0%
layer 4	% =	24.0%	24.0%
layer 5	% =	24.0%	
layer 6	% =	24.0%	
layer 7	% =	24.0%	
layer 8	% =	24.0%	
layer 9	% =		24.0%
layer 10	% =		24.0%
layer 11	% =		24.0%
layer 12	% =		24.0%
layer 13	% =		24.0%
layer 14	% =		24.0%
Average final losses, %	% =	24.0%	24.0%

### Stresses at Transfer

#### STRESS LIMITS FOR CONCRETE

Compression = $0.6f_{ci}$	$f_{ci} =$	3.300 ksi
Tension		
without bonded reinforcement = $-0.0948\sqrt{f_{ci}} \leq -0.2$	=	-0.200 ksi
with bonded auxiliary reinforcement = $-0.22\sqrt{f_{ci}}$	=	-0.016 ksi

#### STRESSES AT TRANSFER LENGTH SECTION

Transfer Length = $60 \times$ (strand diameter)	=	2.5 ft	} Calcs for eccentricity (see 9.6.7.2)
Bending moment at transfer length	$M_g =$	116.4 ft-kips	
center of 12 strands to top fiber of beam at the end	=	7.00 in	
center of 12 strands to bottom fiber of beam at the harp point	=	11.00 in	
center of 12 strands and top fiber of beam at transfer length	=	10.78 in	
center of gravity of 32 strands and bottom fiber of beam	=	3.88 in	
center of gravity of all strands and the bottom fiber of beam at transfer length	=	19.51 in	
center of gravity of all strands and the bottom fiber of beam at the end	=	20.55 in	
Eccentricity of the strand group at transfer length:	$e_h =$	17.09 in	}
Eccentricity at end of beam:	$e =$	16.05 in	

$$f_t = \frac{P_i}{A} - \frac{P_i e}{S_t} + \frac{M_g}{S_t}$$

$$f_b = \frac{P_i}{A} - \frac{P_i e}{S_b} - \frac{M_g}{S_b}$$

		at midspan	at endspan	
Top stress at top fiber of beam	$f_t =$	0.342 ksi	0.342 ksi	OK
Bottom stress at bottom fiber of the beam	$f_b =$	3.021 ksi	3.021 ksi	OK

#### STRESSES AT HARP POINT

Bending moment due to beam weight at 0.3L	$M_g =$	1188.0 ft-kips		
Top stress at top fiber of beam	$f_t =$	0.035 ksi	0.035 ksi	OK
Bottom stress at bottom fiber of the beam	$f_b =$	3.300 ksi	3.300 ksi	OK

#### STRESSES AT MIDSPAN

Bending moment due to beam weight at 0.5L	$M_g =$	1414.3 ft-kips		
Top stress at top fiber of beam	$f_t =$	0.220 ksi	0.211 ksi	OK
Bottom stress at bottom fiber of the beam	$f_b =$	3.144 ksi	3.189 ksi	OK

### HOLD-DOWN FORCES

assume stress in strand before losses =  $0.8f_u$

layer 1	=	221.4 ksi
layer 2	=	221.4 ksi
layer 3	=	221.4 ksi
layer 4	=	221.4 ksi
layer 5	=	221.4 ksi
layer 6	=	221.4 ksi
layer 7	=	221.4 ksi
layer 8	=	221.4 ksi
layer 9	=	221.4 ksi
layer 10	=	221.4 ksi
layer 11	=	221.4 ksi
layer 12	=	221.4 ksi
layer 13	=	221.4 ksi
layer 14	=	221.4 ksi

prestress force per strand before any losses:

layer 1	=	33.9 kips
layer 2	=	33.9 kips
layer 3	=	33.9 kips
layer 4	=	33.9 kips
layer 5	=	33.9 kips
layer 6	=	33.9 kips
layer 7	=	33.9 kips
layer 8	=	33.9 kips
layer 9	=	33.9 kips
layer 10	=	33.9 kips
layer 11	=	33.9 kips
layer 12	=	33.9 kips
layer 13	=	33.9 kips
layer 14	=	33.9 kips
Harp Angle	$\psi$ =	7.2 °

Hold-down force/strand

layer 1	=	4.4 kips/strand
layer 2	=	4.4 kips/strand
layer 3	=	4.4 kips/strand
layer 4	=	4.4 kips/strand
layer 5	=	4.4 kips/strand
layer 6	=	4.4 kips/strand
layer 7	=	4.4 kips/strand
layer 8	=	4.4 kips/strand
layer 9	=	4.4 kips/strand
layer 10	=	4.4 kips/strand
layer 11	=	4.4 kips/strand
layer 12	=	4.4 kips/strand
layer 13	=	4.4 kips/strand
layer 14	=	4.4 kips/strand
Total hold-down force	=	53.39 kips

### Stresses at Service Loads

#### STRESS LIMITS FOR CONCRETE

##### Compression:

Due to permanent loads for load combination Service I

for the precast beam	=	3.150 ksi
for deck	=	1.463 ksi

Due to permanent and transient loads for load combination Service I

for the precast beam	=	4.200 ksi
for deck	=	1.950 ksi

##### Tension:

Load Combination Service III

for the precast beam	=	-0.016 ksi
----------------------	---	------------

STRESSES AT MIDSPAN			
Compression stresses at top fiber of beam	at midspan	at endspan	
$f_s = \frac{P_{pe}}{A} - \frac{P_{pe}e}{S_s} + \frac{(M_D + M_L)}{S_s} + \frac{(M_{w2} + M_{e1})}{S_{tr}}$			
Due to permanent loads	$f_{ig} =$	2.044 ksi	2.044 ksi
$f_{tr} = \frac{P_{pe}}{A} - \frac{P_{pe}e}{S_s} + \frac{(M_D + M_L)}{S_s} + \frac{(M_{w2} + M_{e1})}{S_{tr}} + \frac{(M_{LL1})}{S_{tr}}$			
Due to permanent loads and transient loads	$f_{ig} =$	2.483 ksi	2.483 ksi
Compression stresses at top fiber of deck	at midspan	at endspan	
$f_{tc} = \frac{(M_{w2} + M_{e1})}{S_{tr}}$			
Due to permanent loads	$f_{tc} =$	0.041 ksi	0.041 ksi
$f_x = \frac{(M_{w2} + M_{e1} + M_{LL1})}{S_{tr}}$			
Due to permanent loads and transient loads	$f_{tc} =$	0.470 ksi	0.470 ksi
Tension stresses at top fiber of deck	at midspan	at endspan	
$f_{tr} = \frac{P_{pe}}{A} + \frac{P_{pe}e}{S_s} - \frac{(M_D + M_L)}{S_s} - \frac{(M_{w2} + M_{e1} + 0.8 * M_{LL1})}{S_{tr}}$			
Load Combination Service III	$f_b =$	-0.404 ksi	-0.404 ksi

OK

OK

OK

OK

OK

**Strength Limit State**

POSITIVE MOMENT SECTION			
$M_u = 1.25DC + 1.5DW + 1.75(LL + IM)$	$M_u =$	8381.5 ft-kips	
effective length factor for compression members			
layer 1	k =	0.28	
layer 2	k =	0.28	
layer 3	k =	0.28	
layer 4	k =	0.28	
layer 5	k =	0.28	
layer 6	k =	0.28	
layer 7	k =	0.28	
layer 8	k =	0.28	
layer 9	k =	0.28	
layer 10	k =	0.28	
layer 11	k =	0.28	
layer 12	k =	0.28	
layer 13	k =	0.28	
layer 14	k =	0.28	
	c =	7.0 ft-kips	
average stress in prestressing steel			
layer 1	$f_{ps} =$	269.6 ksi	
layer 2	$f_{ps} =$	269.6 ksi	
layer 3	$f_{ps} =$	269.6 ksi	
layer 4	$f_{ps} =$	269.6 ksi	
layer 5	$f_{ps} =$	269.6 ksi	
layer 6	$f_{ps} =$	269.6 ksi	
layer 7	$f_{ps} =$	269.6 ksi	
layer 8	$f_{ps} =$	269.6 ksi	
layer 9	$f_{ps} =$	269.6 ksi	
layer 10	$f_{ps} =$	269.6 ksi	
layer 11	$f_{ps} =$	269.6 ksi	
layer 12	$f_{ps} =$	269.6 ksi	
layer 13	$f_{ps} =$	269.6 ksi	
layer 14	$f_{ps} =$	269.6 ksi	
nominal flexure resistance			
	a =	5.94 in	
$M_r = \Phi M_n, \Phi = 1.00$	$\Phi M_n =$	10770.5 ft-kips	OK
NEGATIVE MOMENT SECTION			
$M_u = 1.25DC + 1.5DW + 1.75(LL + IM)$	$M_u =$	-4837.2 ft-kips	
	a =	0.19 in	
	$\Phi M_n =$	4794.8 ft-kips	NOT OK



## Shear Design

CRITICAL SECTION AT 0.59		
$V_u = 1.25DC + 1.5DW + 1.75(LL + IM)$	$V_u =$	405.0 kips
$M_u = 1.25DC + 1.5DW + 1.75(LL + IM)$	$M_u =$	-2684.4 ft-kips
or		
$V_u = 1.25DC + 1.5DW + 1.75(LL + IM)$	$V_u =$	364.8 kips
$M_u = 1.25DC + 1.5DW + 1.75(LL + IM)$	$M_u =$	-2877.0 ft-kips
max shear	$V_u =$	405.0 kips
max moment	$M_u =$	2877.0 ft-kips
Shear depth	$d_v =$	73.19 in
Applied factored normal force at the section	$N_u =$	0
Angle of diagonal compressive stresses	$\theta =$	36.00 °

### STRAIN IN FLEXURAL TENSION REINFORCEMENT

$\epsilon_x = \frac{\frac{M}{d_v} + 0.5N_u + 0.5V_u \cot \theta - A_{ps} f_{ps}}{E_s A_s + E_s A_{ps}} \leq 0.002$		
	<b>at midspan</b>	<b>at endspan</b>
resultant compressive stress at centroid	$f_{pc} =$	1.015 ksi
effective stress in prestressing strand after all losses		
layer 1	$f_{po} =$	162.9 ksi
layer 2	$f_{po} =$	162.9 ksi
layer 3	$f_{po} =$	162.9 ksi
layer 4	$f_{po} =$	162.9 ksi
layer 5	$f_{po} =$	162.9 ksi
layer 6	$f_{po} =$	162.9 ksi
layer 7	$f_{po} =$	162.9 ksi
layer 8	$f_{po} =$	162.9 ksi
layer 9	$f_{po} =$	162.9 ksi
layer 10	$f_{po} =$	162.9 ksi
layer 11	$f_{po} =$	162.9 ksi
layer 12	$f_{po} =$	162.9 ksi
layer 13	$f_{po} =$	162.9 ksi
layer 14	$f_{po} =$	162.9 ksi
strain in flexural tension	<b>at midspan</b>	<b>at endspan</b>
layer 1	$\epsilon_x =$	0.002000
layer 2	$\epsilon_x =$	0.002000
layer 3	$\epsilon_x =$	0.002000
layer 4	$\epsilon_x =$	0.002000
layer 5	$\epsilon_x =$	0.002000
layer 6	$\epsilon_x =$	0.002000
layer 7	$\epsilon_x =$	0.002000
layer 8	$\epsilon_x =$	0.002000
layer 9	$\epsilon_x =$	0.002000
layer 10	$\epsilon_x =$	0.002000
layer 11	$\epsilon_x =$	0.002000
layer 12	$\epsilon_x =$	0.002000
layer 13	$\epsilon_x =$	0.002000
layer 14	$\epsilon_x =$	0.002000

## Deflection and Camber

	<b>at midspan</b>	<b>at endspan</b>
Deflection due to Prestressing Force at Transfer	$\Delta_p =$	3.97 in
Deflection due to Beam Self-Weight at Transfer	$\Delta_g =$	-1.49 in
Deflection due to Beam Self-Weight at Erection	$\Delta_g =$	-1.44 in
Deflection due to Haunch and Deck	$\Delta_s =$	-1.95 in
Deflection due to total self weight	$\Delta_{sw} =$	0.59 in
Total Deflection at transfer	$\Delta =$	2.48 in
Total Deflection at erection	$\Delta =$	4.49 in

## Deck Deflection (assuming 12" beam)

Deflection due to Deck Self-Weight	$\Delta_g =$	-1.1984 in
Live load deflection limit = span/800	$=$	0.18 in
Deflection due to live load and impact	$\Delta_L =$	-0.41 in

OK

**Location: Fire above Deck Between Girders**  
**Beam Design: 1/2" Strand**  
**Fire Exposure Status: 3 Hour**

(PCI Bridge Design Manual Section 9.6)



**Material Properties**

CAST-IN-PLACE SLAB		
Actual Thickness	$t_{as} =$	8.0 in
Wearing Surface	$=$	0.5 in
Structural thickness = Actual - Wearing Surface	$t_s =$	7.5 in
Compressive Strength	$f'_c =$	3.02 ksi
Unit Weight	$w_c =$	150.0 pcf
Stress factor of compression block	$\beta_1 =$	0.85

BEAMS: AASHTO-PCI, BT-72 BULB-TEE		
Strength at release	$f'_{ci} =$	5.5 ksi
Strength at 28 days	$f'_c =$	7 ksi
Unit Weight	$w_c =$	150.0 pcf
Overall Beam Length:		
@ end spans	$L =$	110 ft
@ center span	$L =$	119 ft
Design Spans:		
Non-composite beam @ end spans	$L =$	109 ft
Non-composite beam @ center span	$L =$	118 ft
Composite beam @ end spans	$L =$	110 ft
Composite beam @ center span	$L =$	120 ft
Beam Spacing	$S =$	12 ft



**PRESTRESSING STRANDS**

Diameter of single strand		d =	0.5 in
Area of single strand		A =	0.153 in <sup>2</sup>
Temperature of Layer			
	layer 1 (bottom)	T =	68.00 °F
	layer 2	T =	68.00 °F
	layer 3	T =	68.00 °F
	layer 4	T =	68.00 °F
	layer 5	T =	68.00 °F
	layer 6	T =	68.00 °F
	layer 7	T =	68.00 °F
	layer 8	T =	68.00 °F
	layer 9	T =	68.00 °F
	layer 10	T =	68.00 °F
	layer 11	T =	68.00 °F
	layer 12	T =	68.00 °F
	layer 13	T =	68.00 °F
	layer 14	T =	68.00 °F
Ultimate Strength			
initial =	277 ksi		
	layer 1 (bottom)	f <sub>pu</sub> =	277 ksi
	layer 2	f <sub>pu</sub> =	277 ksi
	layer 3	f <sub>pu</sub> =	277 ksi
	layer 4	f <sub>pu</sub> =	277 ksi
	layer 5	f <sub>pu</sub> =	277 ksi
	layer 6	f <sub>pu</sub> =	277 ksi
	layer 7	f <sub>pu</sub> =	277 ksi
	layer 8	f <sub>pu</sub> =	277 ksi
	layer 9	f <sub>pu</sub> =	277 ksi
	layer 10	f <sub>pu</sub> =	277 ksi
	layer 11	f <sub>pu</sub> =	277 ksi
	layer 12	f <sub>pu</sub> =	277 ksi
	layer 13	f <sub>pu</sub> =	277 ksi
	layer 14	f <sub>pu</sub> =	277 ksi
Yield Strength			
initial =	250 ksi		
	layer 1 (bottom)	f <sub>py</sub> =	250 ksi
	layer 2	f <sub>py</sub> =	250 ksi
	layer 3	f <sub>py</sub> =	250 ksi
	layer 4	f <sub>py</sub> =	250 ksi
	layer 5	f <sub>py</sub> =	250 ksi
	layer 6	f <sub>py</sub> =	250 ksi
	layer 7	f <sub>py</sub> =	250 ksi
	layer 8	f <sub>py</sub> =	250 ksi
	layer 9	f <sub>py</sub> =	250 ksi
	layer 10	f <sub>py</sub> =	250 ksi
	layer 11	f <sub>py</sub> =	250 ksi
	layer 12	f <sub>py</sub> =	250 ksi
	layer 13	f <sub>py</sub> =	250 ksi
	layer 14	f <sub>py</sub> =	250 ksi
<b>Stress Limits:</b>			
before transfer	≤ 0.75f <sub>pu</sub> (initial = 207.6)		
	layer 1 (bottom)	f <sub>pi</sub> =	207.6 ksi
	layer 2	f <sub>pi</sub> =	207.6 ksi
	layer 3	f <sub>pi</sub> =	207.6 ksi
	layer 4	f <sub>pi</sub> =	207.6 ksi
	layer 5	f <sub>pi</sub> =	207.6 ksi
	layer 6	f <sub>pi</sub> =	207.6 ksi
	layer 7	f <sub>pi</sub> =	207.6 ksi
	layer 8	f <sub>pi</sub> =	207.6 ksi
	layer 9	f <sub>pi</sub> =	207.6 ksi
	layer 10	f <sub>pi</sub> =	207.6 ksi
	layer 11	f <sub>pi</sub> =	207.6 ksi
	layer 12	f <sub>pi</sub> =	207.6 ksi
	layer 13	f <sub>pi</sub> =	207.6 ksi
	layer 14	f <sub>pi</sub> =	207.6 ksi

at service limit state (after all losses)  $\leq 0.80f_{py}$  (initial = 199.7)

layer 1 (bottom)	$f_{pe} =$	199.7 ksi
layer 2	$f_{pe} =$	199.7 ksi
layer 3	$f_{pe} =$	199.7 ksi
layer 4	$f_{pe} =$	199.7 ksi
layer 5	$f_{pe} =$	199.7 ksi
layer 6	$f_{pe} =$	199.7 ksi
layer 7	$f_{pe} =$	199.7 ksi
layer 8	$f_{pe} =$	199.7 ksi
layer 9	$f_{pe} =$	199.7 ksi
layer 10	$f_{pe} =$	199.7 ksi
layer 11	$f_{pe} =$	199.7 ksi
layer 12	$f_{pe} =$	199.7 ksi
layer 13	$f_{pe} =$	199.7 ksi
layer 14	$f_{pe} =$	199.7 ksi

Modulus of Elasticity

initial = 25982 ksi

layer 1 (bottom)	E =	25982.0 ksi
layer 2	E =	25982.0 ksi
layer 3	E =	25982.0 ksi
layer 4	E =	25982.0 ksi
layer 5	E =	25982.0 ksi
layer 6	E =	25982.0 ksi
layer 7	E =	25982.0 ksi
layer 8	E =	25982.0 ksi
layer 9	E =	25982.0 ksi
layer 10	E =	25982.0 ksi
layer 11	E =	25982.0 ksi
layer 12	E =	25982.0 ksi
layer 13	E =	25982.0 ksi
layer 14	E =	25982.0 ksi

#### MILD STEEL REINFORCING BARS AT ENDSpan

Yield Strength

Layer 1 (Bottom)	$f_y =$	60.0 ksi	68.00 °F
Layer 2 (Top)	$f_y =$	48.0 ksi	1300.00 °F

Modulus of Elasticity

E =	29000.0 ksi
-----	-------------

Layer 1 (Bottom)

Area of steel at midspan (effective flange)	$A_{sm} =$	2.79 in <sup>2</sup>
Area of steel at endspan (effective flange)	$A_{se} =$	2.48 in <sup>2</sup>
Area of temperature and shrinkage steel (12" width)	$A_s =$	0.31 in <sup>2</sup>

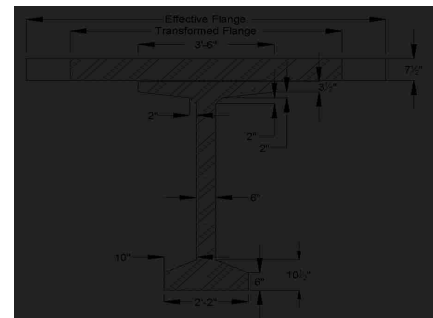
Layer 2 (Top)

Area of steel at midspan (effective flange)	$A_{sm} =$	12.6 in <sup>2</sup>
Area of steel at endspan (effective flange)	$A_{se} =$	12.4 in <sup>2</sup>
Area of temperature and shrinkage steel (12" width)	$A_s =$	0.2 in <sup>2</sup>

#### Cross-sectional Properties

##### NON-COMPOSITE BEAM

Area of cross-section of beam	A =	767.0 in <sup>2</sup>
Overall depth of beam	H =	72.0 in
Moment of Inertia	I =	539,947 in <sup>4</sup>
Distance from centroid to extreme bottom fiber	$y_b =$	36.6 in
Distance from centroid to extreme top fiber	$y_t =$	35.4 in
Section modulus for the extreme bottom fiber	$S_b =$	14915.0 in <sup>3</sup>
Section modulus for the extreme top fiber	$S_t =$	15421.0 in <sup>3</sup>
Weight	$W_t =$	799.0 plf
Modulus of Elasticity = $33000 \cdot (W_c^{1.5}) \cdot (\sqrt{f'_c})$		
cast-in-place concrete deck	$E_{cs} =$	3332 ksi
precast beam at release	$E_{ci} =$	4496 ksi
precast beam at service loads	$E_c =$	5072 ksi



### COMPOSITE BEAM

Effective Flange Width	$b_f =$	111.0 in	*min of three criteria
Modular Ratio = $E_{cs}/E_c$	$n =$	0.6568	
Transformed flange width	$=$	72.9 in	
Transformed flange area	$=$	546.8 in <sup>2</sup>	
Transformed haunch width	$=$	27.6 in	
Transformed haunch area	$=$	13.8 in <sup>2</sup>	

	Transformed Area	$y_b$	$Ay_b$	$A(y_{bc}-y_b)^2$	$I$	$I + A(y_{bc}-y_b)^2$
Beam	767.0 in <sup>2</sup>	36.60 in	28,072.2 in <sup>3</sup>	213,944 in <sup>4</sup>	539,947 in <sup>4</sup>	753,891 in <sup>4</sup>
Haunch	13.8 in <sup>2</sup>	72.25 in	996.6 in <sup>3</sup>	4,953 in <sup>4</sup>	0.33 in <sup>4</sup>	4,953 in <sup>4</sup>
Deck	546.8 in <sup>2</sup>	76.25 in	41,694.5 in <sup>3</sup>	287,973 in <sup>4</sup>	2,950 in <sup>4</sup>	290,922 in <sup>4</sup>
Total	1327.6 in <sup>2</sup>		70,763.3 in <sup>3</sup>			1,049,766 in <sup>4</sup>

Total area of Composite Section	$A_c =$	1328 in <sup>2</sup>
Overall Depth of the Composite Section	$h_c =$	80 in
Moment of Inertia	$I_c =$	1,049,766 in <sup>4</sup>
Distance from centroid to extreme <u>bottom</u> fiber of beam	$y_{bc} =$	53.30 in
Distance from centroid to extreme <u>top</u> fiber of beam	$y_{tg} =$	18.70 in
Distance from centroid to extreme <u>top</u> fiber of slab	$y_{tc} =$	26.70 in
Section modulus for the extreme <u>bottom</u> fiber of beam	$S_{bc} =$	19,694.9 in <sup>3</sup>
Section modulus for the extreme <u>top</u> fiber of beam	$S_{tg} =$	56,141.4 in <sup>3</sup>
Section modulus for the extreme <u>top</u> fiber slab	$S_{tc} =$	59,861.8 in <sup>3</sup>

### DECK (as 12" beam)

Reinforcing per 12"		at midspan	at beams
Layer 1 (Bottom)	$A_s =$	0.3 in <sup>2</sup>	0.3 in <sup>2</sup>
Layer 2 (Top)	$A_s =$	0.2 in <sup>2</sup>	0.2 in <sup>2</sup>

Modulus of Elasticity = $33000 \cdot (W_c^{1.5}) \cdot (\sqrt{f'_c})$ cast-in-place concrete deck	$E_{cs} =$	3332 ksi
--	------------	----------

Moment of Inertia	$I_g =$	125 in <sup>4</sup>	
Distance from centroid to extreme <u>bottom</u> fiber of deck	$y_b =$	2.38 in	
Distance from centroid to extreme <u>top</u> fiber of deck	$y_t =$	5.62 in	
Modulus of Rupture	$f_r =$	412.2 psi	
Cracking Moment	$M_{CR} =$	1.8 ft-kips	
Max negative moment at loading stage	$M_a =$	16.9 ft-kips	21.1 ft-kips
Cracking Moment of Inertia	$I_{cr} =$	87 in <sup>4</sup>	87 in <sup>4</sup>
Effective Moment of Inertia	$I_e =$	87 in <sup>4</sup>	87 in <sup>4</sup>
Effective Moment of Inertia for Continuous Beam	$I_e =$	87 in <sup>4</sup>	

### Shear Forces and Bending Moments

#### DEAD LOADS

Beam self-weight	$w_{beam} =$	0.799 k/f
8 in. deck weight	$w_{deck} =$	1.200 k/f
1/2 in. haunch weight	$w_{haunch} =$	0.022 k/f

LRFD Specifications: Art. 4.6.2.2.1

Width of Deck Constant		OK
Number of beams is not less than four $N_b =$	4	OK
Roadway part of the overhang, $d_o \leq 3.0$ ft, $d_o =$	1.5	OK
Curvature in plans is less than $4^\circ =$	0	OK
Cross-section of the bridge is consistent with one of the cross sections given by LRFD specs		OK

Barrier and wearing surface loads are equally distributed among the 4 beams

Barrier Wt	$W_t =$	0.150 k/f
Dead load of future wearing surface	$DW =$	0.263 k/f

### LIVE LOADS

Fire truck live load front load (Point A)	$P_{live} =$	48.0 kips
Fire truck live load back load (Point B)	$P_{live} =$	22.0 kips
distance between two loads		19.2 ft
distance from nearest edge to point A	$x_a =$	59.0 ft
distance from nearest edge to point B	$x_b =$	39.8 ft
LRFD Specifications: Art. 4.6.2.2.1		
Width of Deck Constant		OK
Number of beams is not less than four $N_b =$	4	OK
Beams are parallel and approximately of the same stiffness		OK
Roadway part of the overhang, $d_o \leq 3.0$ ft, $d_e =$	1.5	OK
Curvature in plans is less than $4^\circ =$	0	OK

Barrier and wearing surface loads are equally distributed among the 4 beams

Bridge Type-- "k" (LRFD Table 4.6.2.2.1-1)

Number of design lanes = $w/12$	=	3 lanes
---------------------------------	---	---------

### Distribution Factor for Bending Moment:

Beams spacing	$S =$	12.0 ft
Depth of concrete slab	$t_s =$	7.5 in
Beam Span	$L =$	120.0 ft
Number of Beams	$N_b =$	4
Modular ratio between beam & deck materials	$n =$	1.5225
Longitudinal stiffness parameter	$K_g =$	2,657,855.02 in <sup>4</sup>

at center span:

$$DFM = 0.75 + \left(\frac{S}{9.5}\right)^{0.6} + \left(\frac{S}{L}\right)^{0.2} + \left(\frac{K_g}{12 * L * I_s}\right)^{0.1}$$

DFM =	0.916 lanes/beam
-------	------------------

0.905 Controls

one design lane loaded:

$$DFM = 0.75 + \left(\frac{S}{14}\right)^{0.4} * \left(\frac{S}{L}\right)^{0.3} * \left(\frac{K_g}{12 * L * I_s}\right)^{0.1}$$

DFM =	0.621 lanes/beam
-------	------------------

### Distribution Factor for Shear Force

both end spans and center span:

$$DFV = 0.2 + \left(\frac{S}{12}\right) - \left(\frac{S}{35}\right)^2$$

DFV =	1.082 lanes/beam
-------	------------------

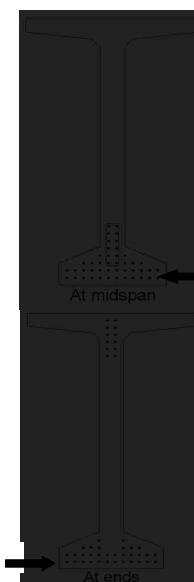
1.082 Controls

one design lane loaded:

$$DFV = 0.36 + \left(\frac{S}{25}\right)$$

DFV =	0.840 lanes/beam
-------	------------------

from bottom	At Midspan		At Ends	
	No. of	Distance from Bottom	No. of	Distance from Bottom
layer 1	12	2	12	2
layer 2	12	4	12	4
layer 3	8	6	6	6
layer 4	4	8	2	8
layer 5	2	10	-	-
layer 6	2	12	-	-
layer 7	2	14	-	-
layer 8	2	16	-	-
layer 9	-	-	2	60
layer 10	-	-	2	62
layer 11	-	-	2	64
layer 12	-	-	2	66
layer 13	-	-	2	68
layer 14	-	-	2	70
<b>Harped Strand Group (included in above totals)</b>				
layer 3	2	6		
layer 4	2	8		
layer 5	2	10		
layer 6	2	12		
layer 7	2	14		
layer 8	2	16		



distance from the center of gravity of strands to the bottom fiber of the beam = 7% of the beam depth  
strand eccentricity at midspan =  $(y_b - y_{bs})$

$y_{bs} =$	5.82 in
$e_c =$	30.78 in

**Prestress Losses**

**ELASTIC SHORTENING**

assumed loss	=	9.00%
--------------	---	-------

Force per strand at transfer		
layer 1	=	28.9 kips
layer 2	=	28.9 kips
layer 3	=	28.9 kips
layer 4	=	28.9 kips
layer 5	=	28.9 kips
layer 6	=	28.9 kips
layer 7	=	28.9 kips
layer 8	=	28.9 kips
layer 9	=	28.9 kips
layer 10	=	28.9 kips
layer 11	=	28.9 kips
layer 12	=	28.9 kips
layer 13	=	28.9 kips
layer 14	=	28.9 kips

		<b>at midspan</b>	<b>at endspan</b>
Total prestressing force at release	$P_i =$	1271.6 kips	1271.6 kips
Sum of concrete stresses at the center of gravity of prestressing tendons due to prestressing force at transfer and the self-weight of the member at sections of maximum moment	$f_{cgp} =$	2.938 ksi	2.938 ksi

Loss due to shortening			
		<b>at midspan</b>	<b>at endspan</b>
layer 1	$\Delta f_{pES} =$	17.0 ksi	17.0 ksi
layer 2	$\Delta f_{pES} =$	17.0 ksi	17.0 ksi
layer 3	$\Delta f_{pES} =$	17.0 ksi	17.0 ksi
layer 4	$\Delta f_{pES} =$	17.0 ksi	17.0 ksi
layer 5	$\Delta f_{pES} =$	17.0 ksi	
layer 6	$\Delta f_{pES} =$	17.0 ksi	
layer 7	$\Delta f_{pES} =$	17.0 ksi	
layer 8	$\Delta f_{pES} =$	17.0 ksi	
layer 9	$\Delta f_{pES} =$		17.0 ksi
layer 10	$\Delta f_{pES} =$		17.0 ksi
layer 11	$\Delta f_{pES} =$		17.0 ksi
layer 12	$\Delta f_{pES} =$		17.0 ksi
layer 13	$\Delta f_{pES} =$		17.0 ksi
layer 14	$\Delta f_{pES} =$		17.0 ksi

**SHRINKAGE**

Shrinkage = $(17 - 0.15 \times \text{Relative Humidity})$	$\Delta f_{pSR} =$	6.5 ksi	← assume relative humidity = 70%
---	--------------------	---------	----------------------------------

**CREEP OF CONCRETE**

Change of stresses at center of gravity of prestressing due to permanent loads except the loads acting at time of applying prestressing force, calculated at the same section as $f_{cgp}$	$\Delta f_{cdp} =$	1.564 ksi	
		<b>at midspan</b>	<b>at endspan</b>
loss due to creep	$\Delta f_{pCR} =$	24.3 ksi	24.3 ksi

**RELAXATION OF PRESTRESSING STRANDS**

loss due to relaxation after transfer		at midspan	at endspan
layer 1	$\Delta f_{pR2} =$	2.1 ksi	2.1 ksi
layer 2	$\Delta f_{pR2} =$	2.1 ksi	2.1 ksi
layer 3	$\Delta f_{pR2} =$	2.1 ksi	2.1 ksi
layer 4	$\Delta f_{pR2} =$	2.1 ksi	2.1 ksi
layer 5	$\Delta f_{pR2} =$	2.1 ksi	
layer 6	$\Delta f_{pR2} =$	2.1 ksi	
layer 7	$\Delta f_{pR2} =$	2.1 ksi	
layer 8	$\Delta f_{pR2} =$	2.1 ksi	
layer 9	$\Delta f_{pR2} =$		2.1 ksi
layer 10	$\Delta f_{pR2} =$		2.1 ksi
layer 11	$\Delta f_{pR2} =$		2.1 ksi
layer 12	$\Delta f_{pR2} =$		2.1 ksi
layer 13	$\Delta f_{pR2} =$		2.1 ksi
layer 14	$\Delta f_{pR2} =$		2.1 ksi

**TOTAL LOSSES AT TRANSFER**

total loss  $\Delta f_{pES} = \Delta f_{pi}$

stress in tendons after transfer  $f_{pt} = f_{pi} - \Delta f_{pi}$

		at midspan	at endspan
layer 1	$f_{pt} =$	190.6 ksi	190.6 ksi
layer 2	$f_{pt} =$	190.6 ksi	190.6 ksi
layer 3	$f_{pt} =$	190.6 ksi	190.6 ksi
layer 4	$f_{pt} =$	190.6 ksi	190.6 ksi
layer 5	$f_{pt} =$	190.6 ksi	
layer 6	$f_{pt} =$	190.6 ksi	
layer 7	$f_{pt} =$	190.6 ksi	
layer 8	$f_{pt} =$	190.6 ksi	
layer 9	$f_{pt} =$		190.6 ksi
layer 10	$f_{pt} =$		190.6 ksi
layer 11	$f_{pt} =$		190.6 ksi
layer 12	$f_{pt} =$		190.6 ksi
layer 13	$f_{pt} =$		190.6 ksi
layer 14	$f_{pt} =$		190.6 ksi

force per strand =  $f_{pt} \cdot \text{strand area}$

		at midspan	at endspan
layer 1	=	29.2 kips	29.2 kips
layer 2	=	29.2 kips	29.2 kips
layer 3	=	29.2 kips	29.2 kips
layer 4	=	29.2 kips	29.2 kips
layer 5	=	29.2 kips	
layer 6	=	29.2 kips	
layer 7	=	29.2 kips	
layer 8	=	29.2 kips	
layer 9	=		29.2 kips
layer 10	=		29.2 kips
layer 11	=		29.2 kips
layer 12	=		29.2 kips
layer 13	=		29.2 kips
layer 14	=		29.2 kips
Total prestressing force after transfer	$P_i =$	1284.8 kips	1284.8 kips

Initial loss =  $(\Delta f_{pi}) / (f_{pi})$

		at midspan	at endspan
layer 1	% =	8.2%	8.2%
layer 2	% =	8.2%	8.2%
layer 3	% =	8.2%	8.2%
layer 4	% =	8.2%	8.2%
layer 5	% =	8.2%	
layer 6	% =	8.2%	
layer 7	% =	8.2%	
layer 8	% =	8.2%	
layer 9	% =		8.2%
layer 10	% =		8.2%
layer 11	% =		8.2%
layer 12	% =		8.2%
layer 13	% =		8.2%
layer 14	% =		8.2%

OK  
OK  
OK  
OK  
OK  
OK  
OK  
OK  
OK  
OK  
OK  
OK  
OK  
OK  
OK



**TOTAL LOSSES AT SERVICE LOADS**

Total Losses		at midspan	at endspan
layer 1	$\Delta f_{pT} =$	49.9 ksi	49.9 ksi
layer 2	$\Delta f_{pT} =$	49.9 ksi	49.9 ksi
layer 3	$\Delta f_{pT} =$	49.9 ksi	49.9 ksi
layer 4	$\Delta f_{pT} =$	49.9 ksi	49.9 ksi
layer 5	$\Delta f_{pT} =$	49.9 ksi	
layer 6	$\Delta f_{pT} =$	49.9 ksi	
layer 7	$\Delta f_{pT} =$	49.9 ksi	
layer 8	$\Delta f_{pT} =$	49.9 ksi	
layer 9	$\Delta f_{pT} =$		49.9 ksi
layer 10	$\Delta f_{pT} =$		49.9 ksi
layer 11	$\Delta f_{pT} =$		49.9 ksi
layer 12	$\Delta f_{pT} =$		49.9 ksi
layer 13	$\Delta f_{pT} =$		49.9 ksi
layer 14	$\Delta f_{pT} =$		49.9 ksi

Stress in tendon after all losses =  $f_{pr} - \Delta f_{pt}$

		at midspan	at endspan
layer 1	$f_{pe} =$	157.7 ksi	157.7 ksi
layer 2	$f_{pe} =$	157.7 ksi	157.7 ksi
layer 3	$f_{pe} =$	157.7 ksi	157.7 ksi
layer 4	$f_{pe} =$	157.7 ksi	157.7 ksi
layer 5	$f_{pe} =$	157.7 ksi	
layer 6	$f_{pe} =$	157.7 ksi	
layer 7	$f_{pe} =$	157.7 ksi	
layer 8	$f_{pe} =$	157.7 ksi	
layer 9	$f_{pe} =$		157.7 ksi
layer 10	$f_{pe} =$		157.7 ksi
layer 11	$f_{pe} =$		157.7 ksi
layer 12	$f_{pe} =$		157.7 ksi
layer 13	$f_{pe} =$		157.7 ksi
layer 14	$f_{pe} =$		157.7 ksi

check prestressing stress limit at service limit state:  $f_{pe} \leq 0.8 f_{py}$

layer 1	=	199.7 ksi
layer 2	=	199.7 ksi
layer 3	=	199.7 ksi
layer 4	=	199.7 ksi
layer 5	=	199.7 ksi
layer 6	=	199.7 ksi
layer 7	=	199.7 ksi
layer 8	=	199.7 ksi
layer 9	=	199.7 ksi
layer 10	=	199.7 ksi
layer 11	=	199.7 ksi
layer 12	=	199.7 ksi
layer 13	=	199.7 ksi
layer 14	=	199.7 ksi

OK  
OK  
OK  
OK  
OK  
OK  
OK  
OK  
OK  
OK  
OK  
OK  
OK  
OK

force per strand =  $f_{pe} \cdot \text{strand area}$

		at midspan	at endspan
layer 1	=	24.1 kips	24.1 kips
layer 2	=	24.1 kips	24.1 kips
layer 3	=	24.1 kips	24.1 kips
layer 4	=	24.1 kips	24.1 kips
layer 5	=	24.1 kips	
layer 6	=	24.1 kips	
layer 7	=	24.1 kips	
layer 8	=	24.1 kips	
layer 9	=		24.1 kips
layer 10	=		24.1 kips
layer 11	=		24.1 kips
layer 12	=		24.1 kips
layer 13	=		24.1 kips
layer 14	=		24.1 kips

		at midspan	at endspan
Total prestressing force after all losses	$P_{pe} =$	1061.6 kips	1061.6 kips
Final losses, % = $(\Delta f_{pT})/(f_{pi})$			
layer 1	% =	24.0%	24.0%
layer 2	% =	24.0%	24.0%
layer 3	% =	24.0%	24.0%
layer 4	% =	24.0%	24.0%
layer 5	% =	24.0%	
layer 6	% =	24.0%	
layer 7	% =	24.0%	
layer 8	% =	24.0%	
layer 9	% =		24.0%
layer 10	% =		24.0%
layer 11	% =		24.0%
layer 12	% =		24.0%
layer 13	% =		24.0%
layer 14	% =		24.0%
Average final losses, %	% =	24.0%	24.0%

### Stresses at Transfer

#### STRESS LIMITS FOR CONCRETE

Compression = $0.6f_{ci}$	$f_{ci} =$	3.300 ksi
Tension		
without bonded reinforcement = $-0.0948\sqrt{f_{ci}} \leq -0.2$	=	-0.200 ksi
with bonded auxiliary reinforcement = $-0.22\sqrt{f_{ci}}$	=	-0.016 ksi

#### STRESSES AT TRANSFER LENGTH SECTION

Transfer Length = $60 \times (\text{strand diameter})$	=	2.5 ft	} Calcs for eccentricity (see 9.6.7.2)
Bending moment at transfer length	$M_g =$	116.4 ft-kips	
center of 12 strands to top fiber of beam at the end	=	7.00 in	
center of 12 strands to bottom fiber of beam at the harp point	=	11.00 in	
center of 12 strands and top fiber of beam at transfer length	=	10.78 in	
center of gravity of 32 strands and bottom fiber of beam	=	3.88 in	
center of gravity of all strands and the bottom fiber of beam at transfer length	=	19.51 in	
center of gravity of all strands and the bottom fiber of beam at the end	=	20.55 in	
Eccentricity of the strand group at transfer length:	$e_{11} =$	17.09 in	}
Eccentricity at end of beam:	$e =$	16.05 in	

$$f_t = \frac{P_i}{A} - \frac{P_i e}{S_t} + \frac{M_g}{S_t}$$

$$f_b = \frac{P_i}{A} + \frac{P_i e}{S_b} - \frac{M_g}{S_b}$$

		at midspan	at endspan	
Top stress at top fiber of beam	$f_t =$	0.342 ksi	0.342 ksi	OK
Bottom stress at bottom fiber of the beam	$f_b =$	3.021 ksi	3.021 ksi	OK

#### STRESSES AT HARP POINT

Bending moment due to beam weight at 0.3L	$M_g =$	1188.0 ft-kips		
Top stress at top fiber of beam	$f_t =$	0.035 ksi	0.035 ksi	OK
Bottom stress at bottom fiber of the beam	$f_b =$	3.300 ksi	3.300 ksi	OK

#### STRESSES AT MIDSPAN

Bending moment due to beam weight at 0.5L	$M_g =$	1414.3 ft-kips		
Top stress at top fiber of beam	$f_t =$	0.220 ksi	0.211 ksi	OK
Bottom stress at bottom fiber of the beam	$f_b =$	3.144 ksi	3.189 ksi	OK

### HOLD-DOWN FORCES

assume stress in strand before losses =  $0.8f_u$

layer 1	=	221.4 ksi
layer 2	=	221.4 ksi
layer 3	=	221.4 ksi
layer 4	=	221.4 ksi
layer 5	=	221.4 ksi
layer 6	=	221.4 ksi
layer 7	=	221.4 ksi
layer 8	=	221.4 ksi
layer 9	=	221.4 ksi
layer 10	=	221.4 ksi
layer 11	=	221.4 ksi
layer 12	=	221.4 ksi
layer 13	=	221.4 ksi
layer 14	=	221.4 ksi

prestress force per strand before any losses:

layer 1	=	33.9 kips
layer 2	=	33.9 kips
layer 3	=	33.9 kips
layer 4	=	33.9 kips
layer 5	=	33.9 kips
layer 6	=	33.9 kips
layer 7	=	33.9 kips
layer 8	=	33.9 kips
layer 9	=	33.9 kips
layer 10	=	33.9 kips
layer 11	=	33.9 kips
layer 12	=	33.9 kips
layer 13	=	33.9 kips
layer 14	=	33.9 kips
Harp Angle	$\psi$ =	7.2 °

Hold-down force/strand

layer 1	=	4.4 kips/strand
layer 2	=	4.4 kips/strand
layer 3	=	4.4 kips/strand
layer 4	=	4.4 kips/strand
layer 5	=	4.4 kips/strand
layer 6	=	4.4 kips/strand
layer 7	=	4.4 kips/strand
layer 8	=	4.4 kips/strand
layer 9	=	4.4 kips/strand
layer 10	=	4.4 kips/strand
layer 11	=	4.4 kips/strand
layer 12	=	4.4 kips/strand
layer 13	=	4.4 kips/strand
layer 14	=	4.4 kips/strand
Total hold-down force	=	53.39 kips

### Stresses at Service Loads

#### STRESS LIMITS FOR CONCRETE

##### Compression:

Due to permanent loads for load combination Service I

for the precast beam	=	3.150 ksi
for deck	=	1.359 ksi

Due to permanent and transient loads for load combination Service I

for the precast beam	=	4.200 ksi
for deck	=	1.812 ksi

##### Tension:

Load Combination Service III

for the precast beam	=	-0.016 ksi
----------------------	---	------------

STRESSES AT MIDSPAN			
Compression stresses at top fiber of beam		at midspan	at endspan
$f_x = \frac{P_{ps}}{A} - \frac{P_{ps}e}{S_x} + \frac{(M_D + M_L)}{S_x} + \frac{(M_{ws} + M_B)}{S_{xg}}$			
Due to permanent loads	$f_{ig} =$	2.045 ksi	2.045 ksi
$f_{ig} = \frac{P_{ps}}{A} - \frac{P_{ps}e}{S_x} + \frac{(M_D + M_L)}{S_x} + \frac{(M_{ws} + M_B)}{S_{xg}} + \frac{(M_{LL+I})}{S_{xg}}$			
Due to permanent loads and transient loads	$f_{ig} =$	2.497 ksi	2.497 ksi
Compression stresses at top fiber of deck		at midspan	at endspan
$f_{tc} = \frac{(M_{ws} + M_B)}{S_{xc}}$			
Due to permanent loads	$f_{tc} =$	0.040 ksi	0.040 ksi
$f_{tc} = \frac{(M_{ws} + M_B + M_{LL+I})}{S_{xc}}$			
Due to permanent loads and transient loads	$f_{tc} =$	0.464 ksi	0.464 ksi
Tension stresses at top fiber of deck		at midspan	at endspan
$f_{tb} = \frac{P_{ps}}{A} + \frac{P_{ps}e}{S_b} - \frac{(M_D + M_L)}{S_b} - \frac{(M_{ws} + M_B + 0.8M_{LL+I})}{S_{bc}}$			
Load Combination Service III	$f_b =$	-0.408 ksi	-0.408 ksi

OK

OK

OK

OK

OK

**Strength Limit State**

POSITIVE MOMENT SECTION		
$M_u = 1.25DC + 1.5DW + 1.75(LL+IM)$	$M_u =$	8381.5 ft-kips
effective length factor for compression members		
layer 1	k =	0.28
layer 2	k =	0.28
layer 3	k =	0.28
layer 4	k =	0.28
layer 5	k =	0.28
layer 6	k =	0.28
layer 7	k =	0.28
layer 8	k =	0.28
layer 9	k =	0.28
layer 10	k =	0.28
layer 11	k =	0.28
layer 12	k =	0.28
layer 13	k =	0.28
layer 14	k =	0.28
	c =	7.5 ft-kips
average stress in prestressing steel		
layer 1	$f_{ps} =$	269.1 ksi
layer 2	$f_{ps} =$	269.1 ksi
layer 3	$f_{ps} =$	269.1 ksi
layer 4	$f_{ps} =$	269.1 ksi
layer 5	$f_{ps} =$	269.1 ksi
layer 6	$f_{ps} =$	269.1 ksi
layer 7	$f_{ps} =$	269.1 ksi
layer 8	$f_{ps} =$	269.1 ksi
layer 9	$f_{ps} =$	269.1 ksi
layer 10	$f_{ps} =$	269.1 ksi
layer 11	$f_{ps} =$	269.1 ksi
layer 12	$f_{ps} =$	269.1 ksi
layer 13	$f_{ps} =$	269.1 ksi
layer 14	$f_{ps} =$	269.1 ksi
nominal flexure resistance		
$M_r = \Phi M_n, \Phi = 1.00$	$\Phi M_n =$	10716.1 ft-kips
NEGATIVE MOMENT SECTION		
$M_u = 1.25DC + 1.5DW + 1.75(LL+IM)$	$M_u =$	-4837.2 ft-kips
	a =	0.18 in
	$\Phi M_n =$	4410.7 ft-kips

OK

NOT OK

### Shear Design

CRITICAL SECTION AT 0.59			
$V_u = 1.25DC + 1.5DW + 1.75(LL+IM)$	$V_u =$	405.0 kips	
$M_u = 1.25DC + 1.5DW + 1.75(LL+IM)$	$M_u =$	-2684.4 ft-kips	
or			
$V_u = 1.25DC + 1.5DW + 1.75(LL+IM)$	$V_u =$	364.8 kips	
$M_u = 1.25DC + 1.5DW + 1.75(LL+IM)$	$M_u =$	-2877.0 ft-kips	
max shear	$V_u =$	405.0 kips	
max moment	$M_u =$	2877.0 ft-kips	
Shear depth	$d_v =$	73.19 in	
Applied factored normal force at the section	$N_u =$	0	
Angle of diagonal compressive stresses	$\theta =$	36.00 °	

### STRAIN IN FLEXURAL TENSION REINFORCEMENT

$$\epsilon_x = \frac{M_u + 0.5N_u + 0.5V_u \cot \theta - A_{ps} f_{ps}}{E_s A_s + E_s A_{ps}} \leq 0.002$$

		at midspan	at endspan
resultant compressive stress at centroid	$f_{pc} =$	1.023 ksi	1.023 ksi
effective stress in prestressing strand after all losses			
layer 1	$f_{po} =$	162.9 ksi	162.9 ksi
layer 2	$f_{po} =$	162.9 ksi	162.9 ksi
layer 3	$f_{po} =$	162.9 ksi	162.9 ksi
layer 4	$f_{po} =$	162.9 ksi	162.9 ksi
layer 5	$f_{po} =$	162.9 ksi	
layer 6	$f_{po} =$	162.9 ksi	
layer 7	$f_{po} =$	162.9 ksi	
layer 8	$f_{po} =$	162.9 ksi	
layer 9	$f_{po} =$		162.9 ksi
layer 10	$f_{po} =$		162.9 ksi
layer 11	$f_{po} =$		162.9 ksi
layer 12	$f_{po} =$		162.9 ksi
layer 13	$f_{po} =$		162.9 ksi
layer 14	$f_{po} =$		162.9 ksi
strain in flexural tension		at midspan	at endspan
layer 1	$\epsilon_x =$	0.002000	0.002000
layer 2	$\epsilon_x =$	0.002000	0.002000
layer 3	$\epsilon_x =$	0.002000	0.002000
layer 4	$\epsilon_x =$	0.002000	0.002000
layer 5	$\epsilon_x =$	0.002000	
layer 6	$\epsilon_x =$	0.002000	
layer 7	$\epsilon_x =$	0.002000	
layer 8	$\epsilon_x =$	0.002000	
layer 9	$\epsilon_x =$		0.002000
layer 10	$\epsilon_x =$		0.002000
layer 11	$\epsilon_x =$		0.002000
layer 12	$\epsilon_x =$		0.002000
layer 13	$\epsilon_x =$		0.002000
layer 14	$\epsilon_x =$		0.002000

### Deflection and Camber

		at midspan	at endspan
Deflection due to Prestressing Force at Transfer	$\Delta_p =$	3.97 in	3.97 in
Deflection due to Beam Self-Weight at Transfer	$\Delta_g =$	-1.49 in	
Deflection due to Beam Self-Weight at Erection	$\Delta_g =$	-1.44 in	
Deflection due to Haunch and Deck	$\Delta_g =$	-1.95 in	
Deflection due to total self weight	$\Delta_{sw} =$	0.59 in	
Total Deflection at transfer	$\Delta =$	2.48 in	2.48 in
Total Deflection at erection	$\Delta =$	4.49 in	4.49 in

### Deck Deflection (assuming 12" beam)

Deflection due to Deck Self-Weight	$\Delta_g =$	-1.2443 in
Live load deflection limit = span/800	$=$	0.18 in
Deflection due to live load and impact	$\Delta_L =$	-0.55 in

OK

**Location: Fire above Deck Between Girders**  
**Beam Design: 1/2" Strand**  
**Fire Exposure Status: 4 Hour**

(PCI Bridge Design Manual Section 9.6)

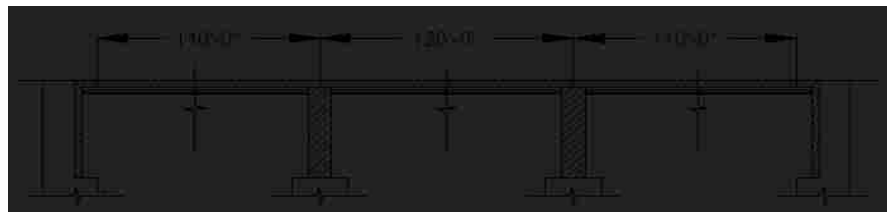


**Material Properties**

CAST-IN-PLACE SLAB		
Actual Thickness	$t_{as} =$	8.0 in
Wearing Surface	$=$	0.5 in
Structural thickness = Actual - Wearing Surface	$t_s =$	7.5 in
Compressive Strength	$f'_c =$	2.83 ksi
Unit Weight	$w_c =$	150.0 pcf
Stress factor of compression block	$\beta_1 =$	0.85

BEAMS: AASHTO-PCI, BT-72 BULB-TEE		
Strength at release	$f'_{ci} =$	5.5 ksi
Strength at 28 days	$f'_c =$	7 ksi
Unit Weight	$w_c =$	150.0 pcf
Overall Beam Length:		
@ end spans	$L =$	110 ft
@ center span	$L =$	119 ft
Design Spans:		
Non-composite beam @ end spans	$L =$	109 ft
Non-composite beam @ center span	$L =$	118 ft
Composite beam @ end spans	$L =$	110 ft
Composite beam @ center span	$L =$	120 ft
Beam Spacing	$S =$	12 ft



**PRESTRESSING STRANDS**

Diameter of single strand		d =	0.5 in
Area of single strand		A =	0.153 in <sup>2</sup>
Temperature of Layer			
	layer 1 (bottom)	T =	68.00 °F
	layer 2	T =	68.00 °F
	layer 3	T =	68.00 °F
	layer 4	T =	68.00 °F
	layer 5	T =	68.00 °F
	layer 6	T =	68.00 °F
	layer 7	T =	68.00 °F
	layer 8	T =	68.00 °F
	layer 9	T =	68.00 °F
	layer 10	T =	68.00 °F
	layer 11	T =	68.00 °F
	layer 12	T =	68.00 °F
	layer 13	T =	68.00 °F
	layer 14	T =	68.00 °F
Ultimate Strength			
initial =	277 ksi		
	layer 1 (bottom)	f <sub>pu</sub> =	277 ksi
	layer 2	f <sub>pu</sub> =	277 ksi
	layer 3	f <sub>pu</sub> =	277 ksi
	layer 4	f <sub>pu</sub> =	277 ksi
	layer 5	f <sub>pu</sub> =	277 ksi
	layer 6	f <sub>pu</sub> =	277 ksi
	layer 7	f <sub>pu</sub> =	277 ksi
	layer 8	f <sub>pu</sub> =	277 ksi
	layer 9	f <sub>pu</sub> =	277 ksi
	layer 10	f <sub>pu</sub> =	277 ksi
	layer 11	f <sub>pu</sub> =	277 ksi
	layer 12	f <sub>pu</sub> =	277 ksi
	layer 13	f <sub>pu</sub> =	277 ksi
	layer 14	f <sub>pu</sub> =	277 ksi
Yield Strength			
initial =	250 ksi		
	layer 1 (bottom)	f <sub>py</sub> =	250 ksi
	layer 2	f <sub>py</sub> =	250 ksi
	layer 3	f <sub>py</sub> =	250 ksi
	layer 4	f <sub>py</sub> =	250 ksi
	layer 5	f <sub>py</sub> =	250 ksi
	layer 6	f <sub>py</sub> =	250 ksi
	layer 7	f <sub>py</sub> =	250 ksi
	layer 8	f <sub>py</sub> =	250 ksi
	layer 9	f <sub>py</sub> =	250 ksi
	layer 10	f <sub>py</sub> =	250 ksi
	layer 11	f <sub>py</sub> =	250 ksi
	layer 12	f <sub>py</sub> =	250 ksi
	layer 13	f <sub>py</sub> =	250 ksi
	layer 14	f <sub>py</sub> =	250 ksi
<b>Stress Limits:</b>			
before transfer	≤ 0.75f <sub>pu</sub> (initial = 207.6)		
	layer 1 (bottom)	f <sub>pi</sub> =	207.6 ksi
	layer 2	f <sub>pi</sub> =	207.6 ksi
	layer 3	f <sub>pi</sub> =	207.6 ksi
	layer 4	f <sub>pi</sub> =	207.6 ksi
	layer 5	f <sub>pi</sub> =	207.6 ksi
	layer 6	f <sub>pi</sub> =	207.6 ksi
	layer 7	f <sub>pi</sub> =	207.6 ksi
	layer 8	f <sub>pi</sub> =	207.6 ksi
	layer 9	f <sub>pi</sub> =	207.6 ksi
	layer 10	f <sub>pi</sub> =	207.6 ksi
	layer 11	f <sub>pi</sub> =	207.6 ksi
	layer 12	f <sub>pi</sub> =	207.6 ksi
	layer 13	f <sub>pi</sub> =	207.6 ksi
	layer 14	f <sub>pi</sub> =	207.6 ksi





### COMPOSITE BEAM

Effective Flange Width	$b_f =$	111.0 in	*min of three criteria
Modular Ratio = $E_{cs}/E_c$	$n =$	0.6358	
Transformed flange width	$=$	70.6 in	
Transformed flange area	$=$	529.3 in <sup>2</sup>	
Transformed haunch width	$=$	26.7 in	
Transformed haunch area	$=$	13.4 in <sup>2</sup>	

	Transformed Area	$y_b$	$Ay_b$	$A(y_{bc}-y_b)^2$	$I$	$I + A(y_{bc}-y_b)^2$
Beam	767.0 in <sup>2</sup>	36.60 in	28,072.2 in <sup>3</sup>	206,008 in <sup>4</sup>	539,947 in <sup>4</sup>	745,955 in <sup>4</sup>
Haunch	13.4 in <sup>2</sup>	72.25 in	964.7 in <sup>3</sup>	4,954 in <sup>4</sup>	0.33 in <sup>4</sup>	4,954 in <sup>4</sup>
Deck	529.3 in <sup>2</sup>	76.25 in	40,361.6 in <sup>3</sup>	286,415 in <sup>4</sup>	2,950 in <sup>4</sup>	289,365 in <sup>4</sup>
Total	1309.7 in <sup>2</sup>		69,398.5 in <sup>3</sup>			1,040,274 in <sup>4</sup>

Total area of Composite Section	$A_c =$	1310 in <sup>2</sup>
Overall Depth of the Composite Section	$h_c =$	80 in
Moment of Inertia	$I_c =$	1,040,274 in <sup>4</sup>
Distance from centroid to extreme <u>bottom</u> fiber of beam	$y_{bc} =$	52.99 in
Distance from centroid to extreme <u>top</u> fiber of beam	$y_{tg} =$	19.01 in
Distance from centroid to extreme <u>top</u> fiber of slab	$y_{tc} =$	27.01 in
Section modulus for the extreme <u>bottom</u> fiber of beam	$S_{bc} =$	19,632.0 in <sup>3</sup>
Section modulus for the extreme <u>top</u> fiber of beam	$S_{tg} =$	54,718.8 in <sup>3</sup>
Section modulus for the extreme <u>top</u> fiber slab	$S_{tc} =$	60,570.1 in <sup>3</sup>

### DECK (as 12" beam)

Reinforcing per 12"		at midspan	at beams
Layer 1 (Bottom)	$A_s =$	0.3 in <sup>2</sup>	0.3 in <sup>2</sup>
Layer 2 (Top)	$A_s =$	0.2 in <sup>2</sup>	0.2 in <sup>2</sup>

Modulus of Elasticity = $33000 \cdot (W_c^{1.5}) \cdot (\sqrt{f'_c})$ cast-in-place concrete deck	$E_{cs} =$	3225 ksi
--	------------	----------

Moment of Inertia	$I_g =$	99 in <sup>4</sup>
Distance from centroid to extreme <u>bottom</u> fiber of deck	$y_b =$	2.17 in
Distance from centroid to extreme <u>top</u> fiber of deck	$y_t =$	5.83 in
Modulus of Rupture	$f_r =$	399.0 psi
Cracking Moment	$M_{CR} =$	1.5 ft-kips
Max negative moment at loading stage	$M_a =$	16.9 ft-kips

Cracking Moment of Inertia	$I_{cr} =$	87 in <sup>4</sup>	87 in <sup>4</sup>
Effective Moment of Inertia	$I_e =$	87 in <sup>4</sup>	87 in <sup>4</sup>
Effective Moment of Inertia for Continuous Beam	$I_e =$	87 in <sup>4</sup>	

### Shear Forces and Bending Moments

#### DEAD LOADS

Beam self-weight	$w_{beam} =$	0.799 k/f
8 in. deck weight	$w_{deck} =$	1.200 k/f
1/2 in. haunch weight	$w_{haunch} =$	0.022 k/f

LRFD Specifications: Art. 4.6.2.2.1		
Width of Deck Constant		OK
Number of beams is not less than four $N_b =$	4	OK
Roadway part of the overhang, $d_o \leq 3.0$ ft, $d_o =$	1.5	OK
Curvature in plans is less than $4^\circ =$	0	OK
Cross-section of the bridge is consistent with one of the cross sections given by LRFD specs		OK

Barrier and wearing surface loads are equally distributed among the 4 beams

Barrier Wt	$W_t =$	0.150 k/f
Dead load of future wearing surface	$DW =$	0.263 k/f

### LIVE LOADS

Fire truck live load front load (Point A)	$P_{live} =$	48.0 kips
Fire truck live load back load (Point B)	$P_{live} =$	22.0 kips
distance between two loads		19.2 ft
distance from nearest edge to point A	$x_a =$	59.0 ft
distance from nearest edge to point B	$x_b =$	39.8 ft
LRFD Specifications: Art. 4.6.2.2.1		
Width of Deck Constant		OK
Number of beams is not less than four $N_b =$	4	OK
Beams are parallel and approximately of the same stiffness		OK
Roadway part of the overhang, $d_o \leq 3.0$ ft, $d_e =$	1.5	OK
Curvature in plans is less than $4^\circ =$	0	OK

Barrier and wearing surface loads are equally distributed among the 4 beams

Bridge Type-- "k" (LRFD Table 4.6.2.2.1-1)

Number of design lanes = $w/12$	=	3 lanes
---------------------------------	---	---------

### Distribution Factor for Bending Moment:

Beams spacing	$S =$	12.0 ft
Depth of concrete slab	$t_s =$	7.5 in
Beam Span	$L =$	120.0 ft
Number of Beams	$N_b =$	4
Modular ratio between beam & deck materials	$n =$	1.5727
Longitudinal stiffness parameter	$K_g =$	2,745,627.03 in <sup>4</sup>

at center span:

$$DFM = 0.75 + \left(\frac{S}{9.5}\right)^{0.6} + \left(\frac{S}{L}\right)^{0.2} + \left(\frac{K_g}{12 * L * t_s^3}\right)^{0.1}$$

DFM =	0.919 lanes/beam
-------	------------------

0.905 Controls

one design lane loaded:

$$DFM = 0.75 + \left(\frac{S}{14}\right)^{0.4} * \left(\frac{S}{L}\right)^{0.3} * \left(\frac{K_g}{12 * L * t_s^3}\right)^{0.1}$$

DFM =	0.623 lanes/beam
-------	------------------

### Distribution Factor for Shear Force

both end spans and center span:

$$DFV = 0.2 + \left(\frac{S}{12}\right) - \left(\frac{S}{35}\right)^2$$

DFV =	1.082 lanes/beam
-------	------------------

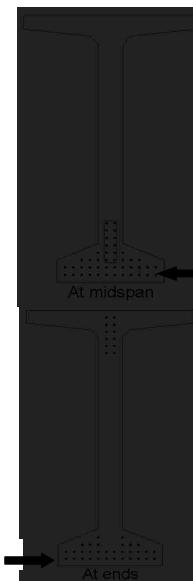
1.082 Controls

one design lane loaded:

$$DFV = 0.36 + \left(\frac{S}{25}\right)$$

DFV =	0.840 lanes/beam
-------	------------------

from bottom	At Midspan		At Ends	
	No. of	Distance from Bottom	No. of	Distance from Bottom
layer 1	12	2	12	2
layer 2	12	4	12	4
layer 3	8	6	6	6
layer 4	4	8	2	8
layer 5	2	10	-	-
layer 6	2	12	-	-
layer 7	2	14	-	-
layer 8	2	16	-	-
layer 9	-	-	2	60
layer 10	-	-	2	62
layer 11	-	-	2	64
layer 12	-	-	2	66
layer 13	-	-	2	68
layer 14	-	-	2	70
<b>Harped Strand Group (included in above totals)</b>				
layer 3	2	6		
layer 4	2	8		
layer 5	2	10		
layer 6	2	12		
layer 7	2	14		
layer 8	2	16		



layer 1

distance from the center of gravity of strands to the bottom fiber of the beam = 7% of the beam depth  
strand eccentricity at midspan =  $(y_b - y_{bs})$

$y_{bs} =$	5.82 in
$e_c =$	30.78 in

**Prestress Losses**

**ELASTIC SHORTENING**

assumed loss	=	9.00%
--------------	---	-------

Force per strand at transfer		
layer 1	=	28.9 kips
layer 2	=	28.9 kips
layer 3	=	28.9 kips
layer 4	=	28.9 kips
layer 5	=	28.9 kips
layer 6	=	28.9 kips
layer 7	=	28.9 kips
layer 8	=	28.9 kips
layer 9	=	28.9 kips
layer 10	=	28.9 kips
layer 11	=	28.9 kips
layer 12	=	28.9 kips
layer 13	=	28.9 kips
layer 14	=	28.9 kips

		<b>at midspan</b>	<b>at endspan</b>
Total prestressing force at release	$P_i =$	1271.6 kips	1271.6 kips
Sum of concrete stresses at the center of gravity of prestressing tendons due to prestressing force at transfer and the self-weight of the member at sections of maximum moment	$f_{cgp} =$	2.938 ksi	2.938 ksi

Loss due to shortening			
		<b>at midspan</b>	<b>at endspan</b>
layer 1	$\Delta f_{pES} =$	17.0 ksi	17.0 ksi
layer 2	$\Delta f_{pES} =$	17.0 ksi	17.0 ksi
layer 3	$\Delta f_{pES} =$	17.0 ksi	17.0 ksi
layer 4	$\Delta f_{pES} =$	17.0 ksi	17.0 ksi
layer 5	$\Delta f_{pES} =$	17.0 ksi	
layer 6	$\Delta f_{pES} =$	17.0 ksi	
layer 7	$\Delta f_{pES} =$	17.0 ksi	
layer 8	$\Delta f_{pES} =$	17.0 ksi	
layer 9	$\Delta f_{pES} =$		17.0 ksi
layer 10	$\Delta f_{pES} =$		17.0 ksi
layer 11	$\Delta f_{pES} =$		17.0 ksi
layer 12	$\Delta f_{pES} =$		17.0 ksi
layer 13	$\Delta f_{pES} =$		17.0 ksi
layer 14	$\Delta f_{pES} =$		17.0 ksi

**SHRINKAGE**

Shrinkage = $(17 - 0.15 \times \text{Relative Humidity})$	$\Delta f_{pSR} =$	6.5 ksi	← assume relative humidity = 70%
---	--------------------	---------	----------------------------------

**CREEP OF CONCRETE**

Change of stresses at center of gravity of prestressing due to permanent loads except the loads acting at time of applying prestressing force, calculated at the same section as $f_{cgp}$	$\Delta f_{cdp} =$	1.564 ksi	
		<b>at midspan</b>	<b>at endspan</b>
loss due to creep	$\Delta f_{pCR} =$	24.3 ksi	24.3 ksi



**RELAXATION OF PRESTRESSING STRANDS**

loss due to relaxation after transfer		at midspan	at endspan
layer 1	$\Delta f_{pR2} =$	2.1 ksi	2.1 ksi
layer 2	$\Delta f_{pR2} =$	2.1 ksi	2.1 ksi
layer 3	$\Delta f_{pR2} =$	2.1 ksi	2.1 ksi
layer 4	$\Delta f_{pR2} =$	2.1 ksi	2.1 ksi
layer 5	$\Delta f_{pR2} =$	2.1 ksi	
layer 6	$\Delta f_{pR2} =$	2.1 ksi	
layer 7	$\Delta f_{pR2} =$	2.1 ksi	
layer 8	$\Delta f_{pR2} =$	2.1 ksi	
layer 9	$\Delta f_{pR2} =$		2.1 ksi
layer 10	$\Delta f_{pR2} =$		2.1 ksi
layer 11	$\Delta f_{pR2} =$		2.1 ksi
layer 12	$\Delta f_{pR2} =$		2.1 ksi
layer 13	$\Delta f_{pR2} =$		2.1 ksi
layer 14	$\Delta f_{pR2} =$		2.1 ksi

**TOTAL LOSSES AT TRANSFER**

total loss  $\Delta f_{pES} = \Delta f_{pi}$

stress in tendons after transfer  $f_{pt} = f_{pi} - \Delta f_{pi}$

		at midspan	at endspan
layer 1	$f_{pt} =$	190.6 ksi	190.6 ksi
layer 2	$f_{pt} =$	190.6 ksi	190.6 ksi
layer 3	$f_{pt} =$	190.6 ksi	190.6 ksi
layer 4	$f_{pt} =$	190.6 ksi	190.6 ksi
layer 5	$f_{pt} =$	190.6 ksi	
layer 6	$f_{pt} =$	190.6 ksi	
layer 7	$f_{pt} =$	190.6 ksi	
layer 8	$f_{pt} =$	190.6 ksi	
layer 9	$f_{pt} =$		190.6 ksi
layer 10	$f_{pt} =$		190.6 ksi
layer 11	$f_{pt} =$		190.6 ksi
layer 12	$f_{pt} =$		190.6 ksi
layer 13	$f_{pt} =$		190.6 ksi
layer 14	$f_{pt} =$		190.6 ksi

force per strand =  $f_{pt} \cdot \text{strand area}$

		at midspan	at endspan
layer 1	=	29.2 kips	29.2 kips
layer 2	=	29.2 kips	29.2 kips
layer 3	=	29.2 kips	29.2 kips
layer 4	=	29.2 kips	29.2 kips
layer 5	=	29.2 kips	
layer 6	=	29.2 kips	
layer 7	=	29.2 kips	
layer 8	=	29.2 kips	
layer 9	=		29.2 kips
layer 10	=		29.2 kips
layer 11	=		29.2 kips
layer 12	=		29.2 kips
layer 13	=		29.2 kips
layer 14	=		29.2 kips
Total prestressing force after transfer	$P_i =$	1284.8 kips	1284.8 kips

Initial loss =  $(\Delta f_{pi}) / (f_{pi})$

		at midspan	at endspan
layer 1	% =	8.2%	8.2%
layer 2	% =	8.2%	8.2%
layer 3	% =	8.2%	8.2%
layer 4	% =	8.2%	8.2%
layer 5	% =	8.2%	
layer 6	% =	8.2%	
layer 7	% =	8.2%	
layer 8	% =	8.2%	
layer 9	% =		8.2%
layer 10	% =		8.2%
layer 11	% =		8.2%
layer 12	% =		8.2%
layer 13	% =		8.2%
layer 14	% =		8.2%

OK  
OK  
OK  
OK  
OK  
OK  
OK  
OK  
OK  
OK  
OK  
OK  
OK  
OK  
OK

**TOTAL LOSSES AT SERVICE LOADS**

Total Losses		at midspan	at endspan
layer 1	$\Delta f_{pT} =$	49.9 ksi	49.9 ksi
layer 2	$\Delta f_{pT} =$	49.9 ksi	49.9 ksi
layer 3	$\Delta f_{pT} =$	49.9 ksi	49.9 ksi
layer 4	$\Delta f_{pT} =$	49.9 ksi	49.9 ksi
layer 5	$\Delta f_{pT} =$	49.9 ksi	
layer 6	$\Delta f_{pT} =$	49.9 ksi	
layer 7	$\Delta f_{pT} =$	49.9 ksi	
layer 8	$\Delta f_{pT} =$	49.9 ksi	
layer 9	$\Delta f_{pT} =$		49.9 ksi
layer 10	$\Delta f_{pT} =$		49.9 ksi
layer 11	$\Delta f_{pT} =$		49.9 ksi
layer 12	$\Delta f_{pT} =$		49.9 ksi
layer 13	$\Delta f_{pT} =$		49.9 ksi
layer 14	$\Delta f_{pT} =$		49.9 ksi

Stress in tendon after all losses = $f_{pr} - \Delta f_{pt}$		at midspan	at endspan
layer 1	$f_{pe} =$	157.7 ksi	157.7 ksi
layer 2	$f_{pe} =$	157.7 ksi	157.7 ksi
layer 3	$f_{pe} =$	157.7 ksi	157.7 ksi
layer 4	$f_{pe} =$	157.7 ksi	157.7 ksi
layer 5	$f_{pe} =$	157.7 ksi	
layer 6	$f_{pe} =$	157.7 ksi	
layer 7	$f_{pe} =$	157.7 ksi	
layer 8	$f_{pe} =$	157.7 ksi	
layer 9	$f_{pe} =$		157.7 ksi
layer 10	$f_{pe} =$		157.7 ksi
layer 11	$f_{pe} =$		157.7 ksi
layer 12	$f_{pe} =$		157.7 ksi
layer 13	$f_{pe} =$		157.7 ksi
layer 14	$f_{pe} =$		157.7 ksi

check prestressing stress limit at service limit state:  $f_{pe} \leq 0.8 f_{py}$

layer 1	=	199.7 ksi
layer 2	=	199.7 ksi
layer 3	=	199.7 ksi
layer 4	=	199.7 ksi
layer 5	=	199.7 ksi
layer 6	=	199.7 ksi
layer 7	=	199.7 ksi
layer 8	=	199.7 ksi
layer 9	=	199.7 ksi
layer 10	=	199.7 ksi
layer 11	=	199.7 ksi
layer 12	=	199.7 ksi
layer 13	=	199.7 ksi
layer 14	=	199.7 ksi

OK  
OK  
OK  
OK  
OK  
OK  
OK  
OK  
OK  
OK  
OK  
OK  
OK  
OK

force per strand =  $f_{pe} \cdot \text{strand area}$

		at midspan	at endspan
layer 1	=	24.1 kips	24.1 kips
layer 2	=	24.1 kips	24.1 kips
layer 3	=	24.1 kips	24.1 kips
layer 4	=	24.1 kips	24.1 kips
layer 5	=	24.1 kips	
layer 6	=	24.1 kips	
layer 7	=	24.1 kips	
layer 8	=	24.1 kips	
layer 9	=		24.1 kips
layer 10	=		24.1 kips
layer 11	=		24.1 kips
layer 12	=		24.1 kips
layer 13	=		24.1 kips
layer 14	=		24.1 kips

		at midspan	at endspan
Total prestressing force after all losses	$P_{pe} =$	1061.7 kips	1061.7 kips
Final losses, % = $(\Delta f_{pT})/(f_{pi})$			
layer 1	% =	24.0%	24.0%
layer 2	% =	24.0%	24.0%
layer 3	% =	24.0%	24.0%
layer 4	% =	24.0%	24.0%
layer 5	% =	24.0%	
layer 6	% =	24.0%	
layer 7	% =	24.0%	
layer 8	% =	24.0%	
layer 9	% =		24.0%
layer 10	% =		24.0%
layer 11	% =		24.0%
layer 12	% =		24.0%
layer 13	% =		24.0%
layer 14	% =		24.0%
Average final losses, %	% =	24.0%	24.0%

### Stresses at Transfer

#### STRESS LIMITS FOR CONCRETE

Compression = $0.6f_{ci}$	$f_{ci} =$	3.300 ksi
Tension		
without bonded reinforcement = $-0.0948\sqrt{f_{ci}} \leq -0.2$	$=$	-0.200 ksi
with bonded auxiliary reinforcement = $-0.22\sqrt{f_{ci}}$	$=$	-0.016 ksi

#### STRESSES AT TRANSFER LENGTH SECTION

Transfer Length = $60 \times (\text{strand diameter})$	$=$	2.5 ft	} Calcs for eccentricity (see 9.6.7.2)
Bending moment at transfer length	$M_g =$	116.4 ft-kips	
center of 12 strands to top fiber of beam at the end	$=$	7.00 in	
center of 12 strands to bottom fiber of beam at the harp point	$=$	11.00 in	
center of 12 strands and top fiber of beam at transfer length	$=$	10.78 in	
center of gravity of 32 strands and bottom fiber of beam	$=$	3.88 in	
center of gravity of all strands and the bottom fiber of beam at transfer length	$=$	19.51 in	
center of gravity of all strands and the bottom fiber of beam at the end	$=$	20.55 in	
Eccentricity of the strand group at transfer length:	$e_{11} =$	17.09 in	}
Eccentricity at end of beam:	$e =$	16.05 in	

$$f_t = \frac{P_i}{A} - \frac{P_i e}{S_t} + \frac{M_g}{S_t}$$

$$f_b = \frac{P_i}{A} + \frac{P_i e}{S_b} - \frac{M_g}{S_b}$$

		at midspan	at endspan	
Top stress at top fiber of beam	$f_t =$	0.342 ksi	0.342 ksi	OK
Bottom stress at bottom fiber of the beam	$f_b =$	3.021 ksi	3.021 ksi	OK

#### STRESSES AT HARP POINT

Bending moment due to beam weight at 0.3L	$M_g =$	1188.0 ft-kips		
Top stress at top fiber of beam	$f_t =$	0.035 ksi	0.035 ksi	OK
Bottom stress at bottom fiber of the beam	$f_b =$	3.300 ksi	3.300 ksi	OK

#### STRESSES AT MIDSPAN

Bending moment due to beam weight at 0.5L	$M_g =$	1414.3 ft-kips		
Top stress at top fiber of beam	$f_t =$	0.220 ksi	0.211 ksi	OK
Bottom stress at bottom fiber of the beam	$f_b =$	3.144 ksi	3.189 ksi	OK

### HOLD-DOWN FORCES

assume stress in strand before losses =  $0.8f_u$

layer 1	=	221.4 ksi
layer 2	=	221.4 ksi
layer 3	=	221.4 ksi
layer 4	=	221.4 ksi
layer 5	=	221.4 ksi
layer 6	=	221.4 ksi
layer 7	=	221.4 ksi
layer 8	=	221.4 ksi
layer 9	=	221.4 ksi
layer 10	=	221.4 ksi
layer 11	=	221.4 ksi
layer 12	=	221.4 ksi
layer 13	=	221.4 ksi
layer 14	=	221.4 ksi

prestress force per strand before any losses:

layer 1	=	33.9 kips
layer 2	=	33.9 kips
layer 3	=	33.9 kips
layer 4	=	33.9 kips
layer 5	=	33.9 kips
layer 6	=	33.9 kips
layer 7	=	33.9 kips
layer 8	=	33.9 kips
layer 9	=	33.9 kips
layer 10	=	33.9 kips
layer 11	=	33.9 kips
layer 12	=	33.9 kips
layer 13	=	33.9 kips
layer 14	=	33.9 kips
Harp Angle	$\psi =$	7.2 °

Hold-down force/strand

layer 1	=	4.4 kips/strand
layer 2	=	4.4 kips/strand
layer 3	=	4.4 kips/strand
layer 4	=	4.4 kips/strand
layer 5	=	4.4 kips/strand
layer 6	=	4.4 kips/strand
layer 7	=	4.4 kips/strand
layer 8	=	4.4 kips/strand
layer 9	=	4.4 kips/strand
layer 10	=	4.4 kips/strand
layer 11	=	4.4 kips/strand
layer 12	=	4.4 kips/strand
layer 13	=	4.4 kips/strand
layer 14	=	4.4 kips/strand
Total hold-down force	=	53.39 kips

### Stresses at Service Loads

#### STRESS LIMITS FOR CONCRETE

##### Compression:

Due to permanent loads for load combination Service I

for the precast beam	=	3.150 ksi
for deck	=	1.274 ksi

Due to permanent and transient loads for load combination Service I

for the precast beam	=	4.200 ksi
for deck	=	1.698 ksi

##### Tension:

Load Combination Service III

for the precast beam	=	-0.016 ksi
----------------------	---	------------

STRESSES AT MIDSPAN			
Compression stresses at top fiber of beam	at midspan	at endspan	
$f_z = \frac{P_{ps}}{A} - \frac{P_{ps}e^2}{S_z} + \frac{(M_D + M_L)}{S_z} + \frac{(M_{ws} + M_D)}{S_{tz}}$			
Due to permanent loads	$f_{tq} =$	2.046 ksi	2.046 ksi
			OK
$f_{tz} = \frac{P_{ps}}{A} - \frac{P_{ps}e^2}{S_z} + \frac{(M_D + M_L)}{S_z} + \frac{(M_{ws} + M_D)}{S_{tz}} + \frac{(M_{LL+I})}{S_{tz}}$			
Due to permanent loads and transient loads	$f_{tq} =$	2.510 ksi	2.510 ksi
			OK
Compression stresses at top fiber of deck	at midspan	at endspan	
$f_{tc} = \frac{(M_{ws} + M_D)}{S_{tc}}$			
Due to permanent loads	$f_{tc} =$	0.040 ksi	0.040 ksi
			OK
$f_{tr} = \frac{(M_{ws} + M_D + M_{LL+I})}{S_{tr}}$			
Due to permanent loads and transient loads	$f_{tc} =$	0.459 ksi	0.459 ksi
			OK
Tension stresses at top fiber of deck	at midspan	at endspan	
$f_{tr} = \frac{P_{ps}}{A} + \frac{P_{ps}e^2}{S_b} - \frac{(M_D + M_L)}{S_b} - \frac{(M_{ws} + M_D + 0.9M_{LL+I})}{S_{bc}}$			
Load Combination Service III	$f_b =$	-0.412 ksi	-0.412 ksi
			OK

### Strength Limit State

POSITIVE MOMENT SECTION			
$M_u = 1.25DC + 1.5DW + 1.75(LL+IM)$	$M_u =$	8381.5 ft-kips	
effective length factor for compression members			
layer 1	k =	0.28	
layer 2	k =	0.28	
layer 3	k =	0.28	
layer 4	k =	0.28	
layer 5	k =	0.28	
layer 6	k =	0.28	
layer 7	k =	0.28	
layer 8	k =	0.28	
layer 9	k =	0.28	
layer 10	k =	0.28	
layer 11	k =	0.28	
layer 12	k =	0.28	
layer 13	k =	0.28	
layer 14	k =	0.28	
	c =	8.0 ft-kips	
average stress in prestressing steel			
layer 1	$f_{ps} =$	268.6 ksi	
layer 2	$f_{ps} =$	268.6 ksi	
layer 3	$f_{ps} =$	268.6 ksi	
layer 4	$f_{ps} =$	268.6 ksi	
layer 5	$f_{ps} =$	268.6 ksi	
layer 6	$f_{ps} =$	268.6 ksi	
layer 7	$f_{ps} =$	268.6 ksi	
layer 8	$f_{ps} =$	268.6 ksi	
layer 9	$f_{ps} =$	268.6 ksi	
layer 10	$f_{ps} =$	268.6 ksi	
layer 11	$f_{ps} =$	268.6 ksi	
layer 12	$f_{ps} =$	268.6 ksi	
layer 13	$f_{ps} =$	268.6 ksi	
layer 14	$f_{ps} =$	268.6 ksi	
nominal flexure resistance			
	a =	6.79 in	
$M_r = \Phi M_n, \Phi = 1.00$	$\Phi M_n =$	10664.7 ft-kips	
			OK
NEGATIVE MOMENT SECTION			
$M_u = 1.25DC + 1.5DW + 1.75(LL+IM)$	$M_u =$	-4837.2 ft-kips	
	a =	0.18 in	
	$\Phi M_n =$	4151.8 ft-kips	
			NOT OK



### Shear Design

CRITICAL SECTION AT 0.59			
$V_u = 1.25DC + 1.5DW + 1.75(LL+IM)$	$V_u =$	405.0 kips	
$M_u = 1.25DC + 1.5DW + 1.75(LL+IM)$	$M_u =$	-2684.4 ft-kips	
or			
$V_u = 1.25DC + 1.5DW + 1.75(LL+IM)$	$V_u =$	364.8 kips	
$M_u = 1.25DC + 1.5DW + 1.75(LL+IM)$	$M_u =$	-2877.0 ft-kips	
max shear	$V_u =$	405.0 kips	
max moment	$M_u =$	2877.0 ft-kips	
Shear depth	$d_v =$	73.19 in	
Applied factored normal force at the section	$N_u =$	0	
Angle of diagonal compressive stresses	$\theta =$	36.00 °	

### STRAIN IN FLEXURAL TENSION REINFORCEMENT

$$\epsilon_x = \frac{M_u + 0.5N_u + 0.5V_u \cot \theta - A_{ps} f_{ps}}{E_s A_s + E_s A_{ps}} \leq 0.002$$

		at midspan	at endspan
resultant compressive stress at centroid	$f_{pc} =$	1.030 ksi	1.030 ksi
effective stress in prestressing strand after all losses			
layer 1	$f_{po} =$	163.0 ksi	163.0 ksi
layer 2	$f_{po} =$	163.0 ksi	163.0 ksi
layer 3	$f_{po} =$	163.0 ksi	163.0 ksi
layer 4	$f_{po} =$	163.0 ksi	163.0 ksi
layer 5	$f_{po} =$	163.0 ksi	
layer 6	$f_{po} =$	163.0 ksi	
layer 7	$f_{po} =$	163.0 ksi	
layer 8	$f_{po} =$	163.0 ksi	
layer 9	$f_{po} =$		163.0 ksi
layer 10	$f_{po} =$		163.0 ksi
layer 11	$f_{po} =$		163.0 ksi
layer 12	$f_{po} =$		163.0 ksi
layer 13	$f_{po} =$		163.0 ksi
layer 14	$f_{po} =$		163.0 ksi
strain in flexural tension		at midspan	at endspan
layer 1	$\epsilon_x =$	0.002000	0.002000
layer 2	$\epsilon_x =$	0.002000	0.002000
layer 3	$\epsilon_x =$	0.002000	0.002000
layer 4	$\epsilon_x =$	0.002000	0.002000
layer 5	$\epsilon_x =$	0.002000	
layer 6	$\epsilon_x =$	0.002000	
layer 7	$\epsilon_x =$	0.002000	
layer 8	$\epsilon_x =$	0.002000	
layer 9	$\epsilon_x =$		0.002000
layer 10	$\epsilon_x =$		0.002000
layer 11	$\epsilon_x =$		0.002000
layer 12	$\epsilon_x =$		0.002000
layer 13	$\epsilon_x =$		0.002000
layer 14	$\epsilon_x =$		0.002000

### Deflection and Camber

		at midspan	at endspan
Deflection due to Prestressing Force at Transfer	$\Delta_p =$	3.97 in	3.97 in
Deflection due to Beam Self-Weight at Transfer	$\Delta_g =$	-1.49 in	
Deflection due to Beam Self-Weight at Erection	$\Delta_g =$	-1.44 in	
Deflection due to Haunch and Deck	$\Delta_g =$	-1.95 in	
Deflection due to total self weight	$\Delta_{sw} =$	0.59 in	
Total Deflection at transfer	$\Delta =$	2.48 in	2.48 in
Total Deflection at erection	$\Delta =$	4.49 in	4.49 in

### Deck Deflection (assuming 12" beam)

Deflection due to Deck Self-Weight	$\Delta_g =$	-1.2857 in
Live load deflection limit = span/800	$=$	0.18 in
Deflection due to live load and impact	$\Delta_L =$	-0.70 in

OK

**Location: Fire above Deck Between Girders**  
**Beam Design: 3/8" Strand**  
**Fire Exposure Status: Undamaged**

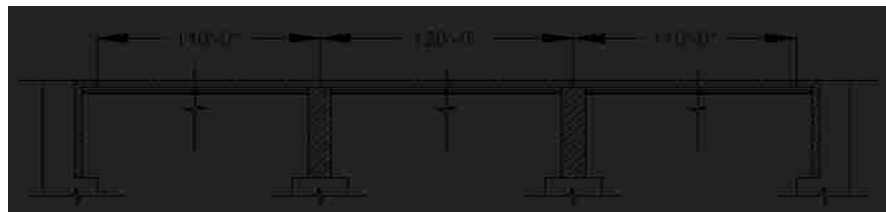
(PCI Bridge Design Manual Section 9.6)



**Material Properties**

CAST-IN-PLACE SLAB			
Actual Thickness	$t_{as} =$		8.0 in
Wearing Surface	$=$		0.5 in
Structural thickness = Actual - Wearing Surface	$t_s =$		7.5 in
Compressive Strength	$f_c =$		4.00 ksi
Unit Weight	$w_c =$		150.0 pcf
Stress factor of compression block	$\beta_1 =$		0.85

BEAMS: AASHTO-PCI, BT-72 BULB-TEE			
Strength at release	$f_{ci} =$		5.5 ksi
Strength at 28 days	$f_c =$		7 ksi
Unit Weight	$w_c =$		150.0 pcf
Overall Beam Length:			
@ end spans	$L =$		110 ft
@ center span	$L =$		119 ft
Design Spans:			
Non-composite beam @ end spans	$L =$		109 ft
Non-composite beam @ center span	$L =$		118 ft
Composite beam @ end spans	$L =$		110 ft
Composite beam @ center span	$L =$		120 ft
Beam Spacing	$S =$		12 ft



**PRESTRESSING STRANDS**

Diameter of single strand	d =	0.4 in
Area of single strand	A =	0.085 in <sup>2</sup>
Temperature of Layer		
	layer 1 (bottom)	T = 68.00 °F
	layer 2	T = 68.00 °F
	layer 3	T = 68.00 °F
	layer 4	T = 68.00 °F
	layer 5	T = 68.00 °F
	layer 6	T = 68.00 °F
	layer 7	T = 68.00 °F
	layer 8	T = 68.00 °F
	layer 9	T = 68.00 °F
	layer 10	T = 68.00 °F
	layer 11	T = 68.00 °F
	layer 12	T = 68.00 °F
	layer 13	T = 68.00 °F
	layer 14	T = 68.00 °F
Ultimate Strength		
initial = 284 ksi	layer 1 (bottom)	f <sub>pu</sub> = 284 ksi
	layer 2	f <sub>pu</sub> = 284 ksi
	layer 3	f <sub>pu</sub> = 284 ksi
	layer 4	f <sub>pu</sub> = 284 ksi
	layer 5	f <sub>pu</sub> = 284 ksi
	layer 6	f <sub>pu</sub> = 284 ksi
	layer 7	f <sub>pu</sub> = 284 ksi
	layer 8	f <sub>pu</sub> = 284 ksi
	layer 9	f <sub>pu</sub> = 284 ksi
	layer 10	f <sub>pu</sub> = 284 ksi
	layer 11	f <sub>pu</sub> = 284 ksi
	layer 12	f <sub>pu</sub> = 284 ksi
	layer 13	f <sub>pu</sub> = 284 ksi
	layer 14	f <sub>pu</sub> = 284 ksi
Yield Strength		
initial = 257 ksi	layer 1 (bottom)	f <sub>py</sub> = 257 ksi
	layer 2	f <sub>py</sub> = 257 ksi
	layer 3	f <sub>py</sub> = 257 ksi
	layer 4	f <sub>py</sub> = 257 ksi
	layer 5	f <sub>py</sub> = 257 ksi
	layer 6	f <sub>py</sub> = 257 ksi
	layer 7	f <sub>py</sub> = 257 ksi
	layer 8	f <sub>py</sub> = 257 ksi
	layer 9	f <sub>py</sub> = 257 ksi
	layer 10	f <sub>py</sub> = 257 ksi
	layer 11	f <sub>py</sub> = 257 ksi
	layer 12	f <sub>py</sub> = 257 ksi
	layer 13	f <sub>py</sub> = 257 ksi
	layer 14	f <sub>py</sub> = 257 ksi
<b>Stress Limits:</b>		
before transfer ≤ 0.75f <sub>pu</sub> (initial = 213.2)	layer 1 (bottom)	f <sub>pi</sub> = 213.2 ksi
	layer 2	f <sub>pi</sub> = 213.2 ksi
	layer 3	f <sub>pi</sub> = 213.2 ksi
	layer 4	f <sub>pi</sub> = 213.2 ksi
	layer 5	f <sub>pi</sub> = 213.2 ksi
	layer 6	f <sub>pi</sub> = 213.2 ksi
	layer 7	f <sub>pi</sub> = 213.2 ksi
	layer 8	f <sub>pi</sub> = 213.2 ksi
	layer 9	f <sub>pi</sub> = 213.2 ksi
	layer 10	f <sub>pi</sub> = 213.2 ksi
	layer 11	f <sub>pi</sub> = 213.2 ksi
	layer 12	f <sub>pi</sub> = 213.2 ksi
	layer 13	f <sub>pi</sub> = 213.2 ksi
	layer 14	f <sub>pi</sub> = 213.2 ksi

at service limit state (after all losses)  $\leq 0.80f_{py}$  (initial = 205.4)

layer 1 (bottom)	$f_{pe} =$	205.4 ksi
layer 2	$f_{pe} =$	205.4 ksi
layer 3	$f_{pe} =$	205.4 ksi
layer 4	$f_{pe} =$	205.4 ksi
layer 5	$f_{pe} =$	205.4 ksi
layer 6	$f_{pe} =$	205.4 ksi
layer 7	$f_{pe} =$	205.4 ksi
layer 8	$f_{pe} =$	205.4 ksi
layer 9	$f_{pe} =$	205.4 ksi
layer 10	$f_{pe} =$	205.4 ksi
layer 11	$f_{pe} =$	205.4 ksi
layer 12	$f_{pe} =$	205.4 ksi
layer 13	$f_{pe} =$	205.4 ksi
layer 14	$f_{pe} =$	205.4 ksi

Modulus of Elasticity

initial = 25898 ksi

layer 1 (bottom)	E =	25898.0 ksi
layer 2	E =	25898.0 ksi
layer 3	E =	25898.0 ksi
layer 4	E =	25898.0 ksi
layer 5	E =	25898.0 ksi
layer 6	E =	25898.0 ksi
layer 7	E =	25898.0 ksi
layer 8	E =	25898.0 ksi
layer 9	E =	25898.0 ksi
layer 10	E =	25898.0 ksi
layer 11	E =	25898.0 ksi
layer 12	E =	25898.0 ksi
layer 13	E =	25898.0 ksi
layer 14	E =	25898.0 ksi

### MILD STEEL REINFORCING BARS AT ENDSpan

Yield Strength

Layer 1 (Bottom)	$f_y =$	60.0 ksi	68.00 °F
Layer 2 (Top)	$f_y =$	60.0 ksi	68.00 °F

Modulus of Elasticity

Layer 1 (Bottom)	E =	29000.0 ksi
Layer 2 (Top)	E =	29000.0 ksi

Layer 1 (Bottom)

Area of steel at midspan (effective flange)	$A_{sm} =$	2.79 in <sup>2</sup>
Area of steel at endspan (effective flange)	$A_{se} =$	2.48 in <sup>2</sup>
Area of temperature and shrinkage steel (12" width)	$A_s =$	0.31 in <sup>2</sup>

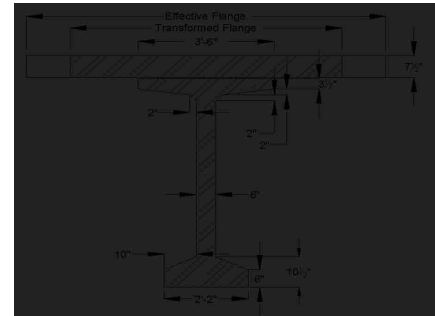
Layer 2 (Top)

Area of steel at midspan (effective flange)	$A_{sm} =$	12.6 in <sup>2</sup>
Area of steel at endspan (effective flange)	$A_{se} =$	12.4 in <sup>2</sup>
Area of temperature and shrinkage steel (12" width)	$A_s =$	0.2 in <sup>2</sup>

### Cross-sectional Properties

#### NON-COMPOSITE BEAM

Area of cross-section of beam	A =	767.0 in <sup>2</sup>
Overall depth of beam	H =	72.0 in
Moment of Inertia	I =	539,947 in <sup>4</sup>
Distance from centroid to extreme <b>bottom</b> fiber	$y_b =$	36.6 in
Distance from centroid to extreme <b>top</b> fiber	$y_t =$	35.4 in
Section modulus for the extreme <b>bottom</b> fiber	$S_b =$	14915.0 in <sup>3</sup>
Section modulus for the extreme <b>top</b> fiber	$S_t =$	15421.0 in <sup>3</sup>
Weight	$W_t =$	799.0 plf
Modulus of Elasticity = $33000 \cdot (W_c^{1.5}) \cdot (\sqrt{f'_c})$		
cast-in-place concrete deck	$E_{cs} =$	3834 ksi
precast beam at release	$E_{ci} =$	4496 ksi
precast beam at service loads	$E_c =$	5072 ksi



### COMPOSITE BEAM

Effective Flange Width	$b_f =$	111.0 in	*min of three criteria
Modular Ratio = $E_{cs}/E_c$	$n =$	0.7559	
Transformed flange width	$=$	83.9 in	
Transformed flange area	$=$	629.3 in <sup>2</sup>	
Transformed haunch width	$=$	31.7 in	
Transformed haunch area	$=$	15.9 in <sup>2</sup>	

	Transformed Area	y <sub>b</sub>	Ay <sub>b</sub>	A(y <sub>bc</sub> -y <sub>b</sub> ) <sup>2</sup>	I	I + A(y <sub>bc</sub> -y <sub>b</sub> ) <sup>2</sup>
Beam	767.0 in <sup>2</sup>	36.60 in	28,072.2 in <sup>3</sup>	250,443 in <sup>4</sup>	539,947 in <sup>4</sup>	790,390 in <sup>4</sup>
Haunch	15.9 in <sup>2</sup>	72.25 in	1,146.9 in <sup>3</sup>	4,906 in <sup>4</sup>	0.33 in <sup>4</sup>	4,906 in <sup>4</sup>
Deck	629.3 in <sup>2</sup>	76.25 in	47,985.0 in <sup>3</sup>	293,069 in <sup>4</sup>	2,950 in <sup>4</sup>	296,019 in <sup>4</sup>
Total	1412.2 in <sup>2</sup>		77,204.1 in <sup>3</sup>			1,091,315 in <sup>4</sup>

Total area of Composite Section	$A_c =$	1412 in <sup>2</sup>
Overall Depth of the Composite Section	$h_c =$	80 in
Moment of Inertia	$I_c =$	1,091,315 in <sup>4</sup>
Distance from centroid to extreme <u>bottom</u> fiber of beam	$y_{bc} =$	54.67 in
Distance from centroid to extreme <u>top</u> fiber of beam	$y_{tb} =$	17.33 in
Distance from centroid to extreme <u>top</u> fiber of slab	$y_{tc} =$	25.33 in
Section modulus for the extreme <u>bottom</u> fiber of beam	$S_{bc} =$	19,961.9 in <sup>3</sup>
Section modulus for the extreme <u>top</u> fiber of beam	$S_{tb} =$	62,972.4 in <sup>3</sup>
Section modulus for the extreme <u>top</u> fiber slab	$S_{tc} =$	56,994.5 in <sup>3</sup>

### DECK (as 12" beam)

Reinforcing per 12"		at midspan	at beams
Layer 1 (Bottom)	$A_s =$	0.3 in <sup>2</sup>	0.3 in <sup>2</sup>
Layer 2 (Top)	$A_s =$	0.2 in <sup>2</sup>	0.2 in <sup>2</sup>

Modulus of Elasticity = $33000 \cdot (W_c^{1.5}) \cdot (\sqrt{f'_c})$	$E_{cs} =$	3834 ksi
cast-in-place concrete deck		
Moment of Inertia	$I_g =$	512 in <sup>4</sup>
Distance from centroid to extreme <u>bottom</u> fiber of deck	$y_b =$	4.00 in
Distance from centroid to extreme <u>top</u> fiber of deck	$y_t =$	4.00 in
Modulus of Rupture	$f_r =$	474.3 psi
Cracking Moment	$M_{CR} =$	5.1 ft-kips
Max negative moment at loading stage	$M_a =$	16.9 ft-kips
Cracking Moment of Inertia	$I_{cr} =$	87 in <sup>4</sup>
Effective Moment of Inertia	$I_e =$	99 in <sup>4</sup>
Effective Moment of Inertia for Continuous Beam	$I_e =$	96 in <sup>4</sup>

### Shear Forces and Bending Moments

#### DEAD LOADS

Beam self-weight	$W_{beam} =$	0.799 k/f
8 in. deck weight	$W_{deck} =$	1.200 k/f
1/2 in. haunch weight	$W_{haunch} =$	0.022 k/f

LRFD Specifications: Art. 4.6.2.2.1		
Width of Deck Constant		OK
Number of beams is not less than four $N_b =$	4	OK
Roadway part of the overhang, $d_o \leq 3.0$ ft, $d_o =$	1.5	OK
Curvature in plans is less than 4° =	0	OK
Cross-section of the bridge is consistent with one of the cross sections given by LRFD specs		OK

Barrier and wearing surface loads are equally distributed among the 4 beams

Barrier Wt	$W_t =$	0.150 k/f
Dead load of future wearing surface	$DW =$	0.263 k/f

LIVE LOADS		
Fire truck live load front load (Point A)	$P_{live} =$	48.0 kips
Fire truck live load back load (Point B)	$P_{live} =$	22.0 kips
distance between two loads		19.2 ft
distance from nearest edge to point A	$x_a =$	59.0 ft
distance from nearest edge to point B	$x_b =$	39.8 ft
LRFD Specifications: Art. 4.6.2.2.1		
Width of Deck Constant		OK
Number of beams is not less than four $N_b =$	4	OK
Beams are parallel and approximately of the same stiffness		OK
Roadway part of the overhang, $d_o \leq 3.0$ ft, $d_o =$	1.5	OK
Curvature in plans is less than $4^\circ =$	0	OK

Barrier and wearing surface loads are equally distributed among the 4 beams

Bridge Type-- "k" (LRFD Table 4.6.2.2.1-1)		
Number of design lanes = $w/12$	=	3 lanes

**Distribution Factor for Bending Moment:**

Beams spacing	$S =$	12.0 ft
Depth of concrete slab	$t_s =$	7.5 in
Beam Span	$L =$	120.0 ft
Number of Beams	$N_b =$	4
Modular ratio between beam & deck materials	$n =$	1.3229
Longitudinal stiffness parameter	$K_y =$	2,309,429.79 in <sup>4</sup>

at center span:		
$DFM = 0.75 + \left(\frac{S}{9.5}\right)^{0.6} * \left(\frac{S}{L}\right)^{0.2} * \left(\frac{K_y}{12 * L * t_s^3}\right)^{0.1}$		
DFM =		0.905 lanes/beam

0.905 Controls

one design lane loaded:		
$DFM = 0.75 + \left(\frac{S}{14}\right)^{0.6} * \left(\frac{S}{L}\right)^{0.3} * \left(\frac{K_y}{12 * L * t_s^3}\right)^{0.1}$		
DFM =		0.614 lanes/beam

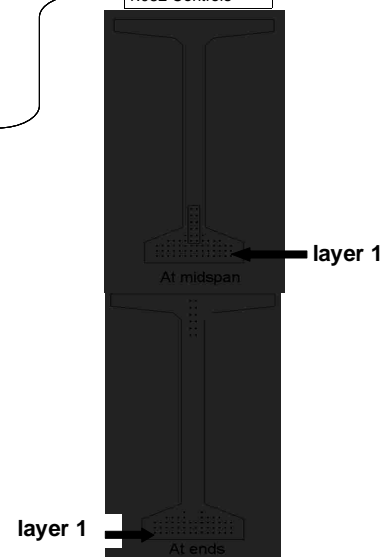
**Distribution Factor for Shear Force**

both end spans and center span:		
$DFV = 0.2 + \left(\frac{S}{12}\right) - \left(\frac{S}{35}\right)^2$		
DFV =		1.082 lanes/beam

1.082 Controls

one design lane loaded:		
$DFV = 0.36 + \left(\frac{S}{25}\right)$		
DFV =		0.840 lanes/beam

from bottom	At Midspan		At Ends	
	No. of	Distance from Bottom	No. of	Distance from Bottom
layer 1	14	2	14	2
layer 2	14	3.5	14	3.5
layer 3	14	5	14	5
layer 4	10	6.5	8	6.5
layer 5	4	8	2	8
layer 6	2	10	-	-
layer 7	2	12	-	-
layer 8	2	14	-	-
layer 9	2	16	2	60
layer 10	-	-	2	62
layer 11	-	-	2	64
layer 12	-	-	2	66
layer 13	-	-	2	68
layer 14	-	-	2	70
	64		64	
<b>Harped Strand Group (included in above totals)</b>				
layer 3	2	6		
layer 4	2	8		
layer 5	2	10		
layer 6	2	12		
layer 7	2	14		
layer 8	2	16		



distance from the center of gravity of strands to the bottom fiber of the beam = 7% of the beam depth  
strand eccentricity at midspan = ( $y_b - y_{bs}$ )

$y_{bs} =$	5.44 in
$e_c =$	31.16 in

### Prestress Losses

#### ELASTIC SHORTENING

assumed loss	=	6.00%
--------------	---	-------

Force per strand at transfer

layer 1	=	17.0 kips
layer 2	=	17.0 kips
layer 3	=	17.0 kips
layer 4	=	17.0 kips
layer 5	=	17.0 kips
layer 6	=	17.0 kips
layer 7	=	17.0 kips
layer 8	=	17.0 kips
layer 9	=	17.0 kips
layer 10	=	17.0 kips
layer 11	=	17.0 kips
layer 12	=	17.0 kips
layer 13	=	17.0 kips
layer 14	=	17.0 kips

Total prestressing force at release	$P_i =$	1088.0 kips	at midspan	1054.0 kips	at endspan
-------------------------------------	---------	-------------	------------	-------------	------------

Sum of concrete stresses at the center of gravity of prestressing tendons due to prestressing force at transfer and the self-weight of the member at sections of maximum moment

$f_{cgp} =$	2.412 ksi	2.307 ksi
-------------	-----------	-----------

Loss due to shortening

		at midspan	at endspan
layer 1	$\Delta f_{pES} =$	13.9 ksi	13.3 ksi
layer 2	$\Delta f_{pES} =$	13.9 ksi	13.3 ksi
layer 3	$\Delta f_{pES} =$	13.9 ksi	13.3 ksi
layer 4	$\Delta f_{pES} =$	13.9 ksi	13.3 ksi
layer 5	$\Delta f_{pES} =$	13.9 ksi	13.3 ksi
layer 6	$\Delta f_{pES} =$	13.9 ksi	
layer 7	$\Delta f_{pES} =$	13.9 ksi	
layer 8	$\Delta f_{pES} =$	13.9 ksi	
layer 9	$\Delta f_{pES} =$	13.9 ksi	13.3 ksi
layer 10	$\Delta f_{pES} =$		13.3 ksi
layer 11	$\Delta f_{pES} =$		13.3 ksi
layer 12	$\Delta f_{pES} =$		13.3 ksi
layer 13	$\Delta f_{pES} =$		13.3 ksi
layer 14	$\Delta f_{pES} =$		13.3 ksi

#### SHRINKAGE

Shrinkage =  $(17 - 0.15 \cdot \text{Relative Humidity})$

$\Delta f_{pSR} =$	6.5 ksi
--------------------	---------

← assume relative humidity = 70%

#### CREEP OF CONCRETE

Change of stresses at center of gravity of prestressing due to permanent loads except the loads acting at time of applying prestressing force, calculated at the same section as  $f_{cgp}$

$\Delta f_{cdp} =$	1.582 ksi	
--------------------	-----------	--

loss due to creep	$\Delta f_{PCR} =$	17.9 ksi	16.6 ksi
-------------------	--------------------	----------	----------

**RELAXATION OF PRESTRESSING STRANDS**

loss due to relaxation after transfer		at midspan	at endspan
layer 1	$\Delta f_{pR2} =$	2.9 ksi	2.9 ksi
layer 2	$\Delta f_{pR2} =$	2.9 ksi	2.9 ksi
layer 3	$\Delta f_{pR2} =$	2.9 ksi	2.9 ksi
layer 4	$\Delta f_{pR2} =$	2.9 ksi	2.9 ksi
layer 5	$\Delta f_{pR2} =$	2.9 ksi	2.9 ksi
layer 6	$\Delta f_{pR2} =$	2.9 ksi	
layer 7	$\Delta f_{pR2} =$	2.9 ksi	
layer 8	$\Delta f_{pR2} =$	2.9 ksi	
layer 9	$\Delta f_{pR2} =$	2.9 ksi	2.9 ksi
layer 10	$\Delta f_{pR2} =$		2.9 ksi
layer 11	$\Delta f_{pR2} =$		2.9 ksi
layer 12	$\Delta f_{pR2} =$		2.9 ksi
layer 13	$\Delta f_{pR2} =$		2.9 ksi
layer 14	$\Delta f_{pR2} =$		2.9 ksi

**TOTAL LOSSES AT TRANSFER**

total loss $\Delta f_{pES} = \Delta f_{pi}$		at midspan	at endspan
stress in tendons after transfer $f_{pt} = f_{pi} - \Delta f_{pi}$			
layer 1	$f_{pt} =$	199.3 ksi	199.9 ksi
layer 2	$f_{pt} =$	199.3 ksi	199.9 ksi
layer 3	$f_{pt} =$	199.3 ksi	199.9 ksi
layer 4	$f_{pt} =$	199.3 ksi	199.9 ksi
layer 5	$f_{pt} =$	199.3 ksi	199.9 ksi
layer 6	$f_{pt} =$	199.3 ksi	
layer 7	$f_{pt} =$	199.3 ksi	
layer 8	$f_{pt} =$	199.3 ksi	
layer 9	$f_{pt} =$	199.3 ksi	199.9 ksi
layer 10	$f_{pt} =$		199.9 ksi
layer 11	$f_{pt} =$		199.9 ksi
layer 12	$f_{pt} =$		199.9 ksi
layer 13	$f_{pt} =$		199.9 ksi
layer 14	$f_{pt} =$		199.9 ksi
force per strand = $f_{pi} \times$ strand area		at midspan	at endspan
layer 1	=	16.9 kips	17.0 kips
layer 2	=	16.9 kips	17.0 kips
layer 3	=	16.9 kips	17.0 kips
layer 4	=	16.9 kips	17.0 kips
layer 5	=	16.9 kips	17.0 kips
layer 6	=	16.9 kips	
layer 7	=	16.9 kips	
layer 8	=	16.9 kips	
layer 9	=	16.9 kips	17.0 kips
layer 10	=		17.0 kips
layer 11	=		17.0 kips
layer 12	=		17.0 kips
layer 13	=		17.0 kips
layer 14	=		17.0 kips
Total prestressing force after transfer	$P_i =$	1047.8 kips	1054.0 kips
Initial loss = $(\Delta f_{pi}) / (f_{pi})$		at midspan	at endspan
layer 1	% =	6.5%	6.2%
layer 2	% =	6.5%	6.2%
layer 3	% =	6.5%	6.2%
layer 4	% =	6.5%	6.2%
layer 5	% =	6.5%	6.2%
layer 6	% =	6.5%	
layer 7	% =	6.5%	
layer 8	% =	6.5%	
layer 9	% =	6.5%	6.2%
layer 10	% =		6.2%
layer 11	% =		6.2%
layer 12	% =		6.2%
layer 13	% =		6.2%
layer 14	% =		6.2%

OK  
OK  
OK  
OK  
OK  
OK  
OK  
OK  
OK  
OK  
OK  
OK  
OK  
OK  
OK



**TOTAL LOSSES AT SERVICE LOADS**

Total Losses		at midspan	at endspan
layer 1	$\Delta f_{pT} =$	41.1 ksi	40.5 ksi
layer 2	$\Delta f_{pT} =$	41.1 ksi	40.5 ksi
layer 3	$\Delta f_{pT} =$	41.1 ksi	40.5 ksi
layer 4	$\Delta f_{pT} =$	41.1 ksi	40.5 ksi
layer 5	$\Delta f_{pT} =$	41.1 ksi	40.5 ksi
layer 6	$\Delta f_{pT} =$	41.1 ksi	
layer 7	$\Delta f_{pT} =$	41.1 ksi	
layer 8	$\Delta f_{pT} =$	41.1 ksi	
layer 9	$\Delta f_{pT} =$	41.1 ksi	40.5 ksi
layer 10	$\Delta f_{pT} =$		40.5 ksi
layer 11	$\Delta f_{pT} =$		40.5 ksi
layer 12	$\Delta f_{pT} =$		40.5 ksi
layer 13	$\Delta f_{pT} =$		40.5 ksi
layer 14	$\Delta f_{pT} =$		40.5 ksi

Stress in tendon after all losses =  $f_{pi} - \Delta f_{pt}$

		at midspan	at endspan
layer 1	$f_{pe} =$	172.0 ksi	172.6 ksi
layer 2	$f_{pe} =$	172.0 ksi	172.6 ksi
layer 3	$f_{pe} =$	172.0 ksi	172.6 ksi
layer 4	$f_{pe} =$	172.0 ksi	172.6 ksi
layer 5	$f_{pe} =$	172.0 ksi	172.6 ksi
layer 6	$f_{pe} =$	172.0 ksi	
layer 7	$f_{pe} =$	172.0 ksi	
layer 8	$f_{pe} =$	172.0 ksi	
layer 9	$f_{pe} =$	172.0 ksi	172.6 ksi
layer 10	$f_{pe} =$		172.6 ksi
layer 11	$f_{pe} =$		172.6 ksi
layer 12	$f_{pe} =$		172.6 ksi
layer 13	$f_{pe} =$		172.6 ksi
layer 14	$f_{pe} =$		172.6 ksi

check prestressing stress limit at service limit state:  $f_{pe} \leq 0.8 * f_{py}$

layer 1	=	205.4 ksi
layer 2	=	205.4 ksi
layer 3	=	205.4 ksi
layer 4	=	205.4 ksi
layer 5	=	205.4 ksi
layer 6	=	205.4 ksi
layer 7	=	205.4 ksi
layer 8	=	205.4 ksi
layer 9	=	205.4 ksi
layer 10	=	205.4 ksi
layer 11	=	205.4 ksi
layer 12	=	205.4 ksi
layer 13	=	205.4 ksi
layer 14	=	205.4 ksi

OK  
OK  
OK  
OK  
OK  
OK  
OK  
OK  
OK  
OK  
OK  
OK  
OK  
OK

force per strand =  $f_{pe} * \text{strand area}$

		at midspan	at endspan
layer 1	=	14.6 kips	14.7 kips
layer 2	=	14.6 kips	14.7 kips
layer 3	=	14.6 kips	14.7 kips
layer 4	=	14.6 kips	14.7 kips
layer 5	=	14.6 kips	14.7 kips
layer 6	=	14.6 kips	
layer 7	=	14.6 kips	
layer 8	=	14.6 kips	
layer 9	=	14.6 kips	14.7 kips
layer 10	=		14.7 kips
layer 11	=		14.7 kips
layer 12	=		14.7 kips
layer 13	=		14.7 kips
layer 14	=		14.7 kips

		at midspan	at endspan
Total prestressing force after all losses	$P_{pe} =$	935.7 kips	939.1 kips
Final losses, % = $(\Delta f_{pT})/(f_{pi})$			
layer 1	% =	19.3%	19.0%
layer 2	% =	19.3%	19.0%
layer 3	% =	19.3%	19.0%
layer 4	% =	19.3%	19.0%
layer 5	% =	19.3%	19.0%
layer 6	% =	19.3%	
layer 7	% =	19.3%	
layer 8	% =	19.3%	
layer 9	% =	19.3%	19.0%
layer 10	% =		19.0%
layer 11	% =		19.0%
layer 12	% =		19.0%
layer 13	% =		19.0%
layer 14	% =		19.0%
Average final losses, %	% =	19.3%	19.0%

### Stresses at Transfer

#### STRESS LIMITS FOR CONCRETE

Compression = $0.6f_{ci}$	$f_{ci} =$	3.300 ksi
Tension		
without bonded reinforcement = $-0.0948\sqrt{f_{ci}} \leq -0.2$	=	-0.200 ksi
with bonded auxiliary reinforcement = $-0.22\sqrt{f_{ci}}$	=	-0.016 ksi

#### STRESSES AT TRANSFER LENGTH SECTION

Transfer Length = $60 \times (\text{strand diameter})$	=	1.9 ft	} Calcs for eccentricity (see 9.6.7.2)
Bending moment at transfer length	$M_g =$	87.7 ft-kips	
center of 12 strands to top fiber of beam at the end	=	7.00 in	
center of 12 strands to bottom fiber of beam at the harp point	=	11.00 in	
center of gravity of 12 strands and top fiber of beam at transfer length	=	9.84 in	
center of gravity of 32 strands and bottom fiber of beam	=	3.98 in	
center of gravity of all strands and the bottom fiber of beam at transfer length	=	15.24 in	
center of gravity of all strands and the bottom fiber of beam at the end	=	15.30 in	
Eccentricity of the strand group at transfer length:	$e_n =$	21.36 in	}
Eccentricity at end of beam:	$e =$	21.30 in	

$$f_t = \frac{P_i}{A} - \frac{P_i e}{S_t} + \frac{M_g}{S_t}$$

$$f_b = \frac{P_i}{A} + \frac{P_i e}{S_b} - \frac{M_g}{S_b}$$

		at midspan	at endspan
Top stress at top fiber of beam	$f_t =$	-0.017 ksi	-0.017 ksi
Bottom stress at bottom fiber of the beam	$f_b =$	2.906 ksi	2.906 ksi

OK  
OK

#### STRESSES AT HARP POINT

Bending moment due to beam weight at 0.3L	$M_g =$	1188.0 ft-kips	
Top stress at top fiber of beam	$f_t =$	0.173 ksi	0.169 ksi
Bottom stress at bottom fiber of the beam	$f_b =$	2.736 ksi	2.621 ksi

OK  
OK

#### STRESSES AT MIDSPAN

Bending moment due to beam weight at 0.5L	$M_g =$	1414.3 ft-kips	
Top stress at top fiber of beam	$f_t =$	0.320 ksi	0.345 ksi
Bottom stress at bottom fiber of the beam	$f_b =$	2.554 ksi	2.438 ksi

OK  
OK

### HOLD-DOWN FORCES

assume stress in strand before losses =  $0.8f_u$

layer 1	=	227.4 ksi
layer 2	=	227.4 ksi
layer 3	=	227.4 ksi
layer 4	=	227.4 ksi
layer 5	=	227.4 ksi
layer 6	=	227.4 ksi
layer 7	=	227.4 ksi
layer 8	=	227.4 ksi
layer 9	=	227.4 ksi
layer 10	=	227.4 ksi
layer 11	=	227.4 ksi
layer 12	=	227.4 ksi
layer 13	=	227.4 ksi
layer 14	=	227.4 ksi

prestress force per strand before any losses:

layer 1	=	19.3 kips
layer 2	=	19.3 kips
layer 3	=	19.3 kips
layer 4	=	19.3 kips
layer 5	=	19.3 kips
layer 6	=	19.3 kips
layer 7	=	19.3 kips
layer 8	=	19.3 kips
layer 9	=	19.3 kips
layer 10	=	19.3 kips
layer 11	=	19.3 kips
layer 12	=	19.3 kips
layer 13	=	19.3 kips
layer 14	=	19.3 kips
Harp Angle	$\psi$ =	7.2 °

Hold-down force/strand

layer 1	=	2.5 kips/strand
layer 2	=	2.5 kips/strand
layer 3	=	2.5 kips/strand
layer 4	=	2.5 kips/strand
layer 5	=	2.5 kips/strand
layer 6	=	2.5 kips/strand
layer 7	=	2.5 kips/strand
layer 8	=	2.5 kips/strand
layer 9	=	2.5 kips/strand
layer 10	=	2.5 kips/strand
layer 11	=	2.5 kips/strand
layer 12	=	2.5 kips/strand
layer 13	=	2.5 kips/strand
layer 14	=	2.5 kips/strand
Total hold-down force	=	30.45 kips

### Stresses at Service Loads

#### STRESS LIMITS FOR CONCRETE

##### Compression:

Due to permanent loads for load combination Service I

for the precast beam	=	3.150 ksi
for deck	=	1.800 ksi

Due to permanent and transient loads for load combination Service I

for the precast beam	=	4.200 ksi
for deck	=	2.400 ksi

##### Tension:

Load Combination Service III

for the precast beam	=	-0.016 ksi
----------------------	---	------------

STRESSES AT MIDSPAN			
Compression stresses at top fiber of beam		at midspan	at endspan
$f_s = \frac{P_{pe}}{A} - \frac{P_{pe}e}{S_t} + \frac{(M_D + M_L)}{S_t} + \frac{(M_{L2} + M_D)}{S_{L2}}$			
Due to permanent loads	$f_{ig} =$	2.105 ksi	2.102 ksi
$f_{L2} = \frac{P_{pe}}{A} - \frac{P_{pe}e}{S_t} + \frac{(M_D + M_L)}{S_t} + \frac{(M_{L2} + M_D)}{S_{L2}} + \frac{(M_{L+1})}{S_{L2}}$			
Due to permanent loads and transient loads	$f_{ig} =$	2.508 ksi	2.505 ksi
Compression stresses at top fiber of deck		at midspan	at endspan
$f_{tr} = \frac{(M_{L2} + M_D)}{S_{tr}}$			
Due to permanent loads	$f_{ic} =$	0.042 ksi	0.042 ksi
$f_{tr} = \frac{(M_{L2} + M_D + M_{L+1})}{S_{tr}}$			
Due to permanent loads and transient loads	$f_{ic} =$	0.488 ksi	0.488 ksi
Tension stresses at top fiber of deck		at midspan	at endspan
$f_{tr} = \frac{P_{pe}}{A} + \frac{P_{pe}e}{S_b} - \frac{(M_D + M_L)}{S_b} - \frac{(M_{L2}   M_D   0.8 * M_{L+1})}{S_{tr}}$			
Load Combination Service III	$f_b =$	-0.793 ksi	-0.782 ksi

OK

OK

OK

OK

OK

**Strength Limit State**

POSITIVE MOMENT SECTION		
$M_u = 1.25DC + 1.5DW + 1.75(LL + IM)$	$M_u =$	8381.5 ft-kips
effective length factor for compression members		
layer 1	k =	0.27
layer 2	k =	0.27
layer 3	k =	0.27
layer 4	k =	0.27
layer 5	k =	0.27
layer 6	k =	0.27
layer 7	k =	0.27
layer 8	k =	0.27
layer 9	k =	0.27
layer 10	k =	0.27
layer 11	k =	0.27
layer 12	k =	0.27
layer 13	k =	0.27
layer 14	k =	0.27
	c =	4.6 ft-kips
average stress in prestressing steel		
layer 1	$f_{ps} =$	279.4 ksi
layer 2	$f_{ps} =$	279.4 ksi
layer 3	$f_{ps} =$	279.4 ksi
layer 4	$f_{ps} =$	279.4 ksi
layer 5	$f_{ps} =$	279.4 ksi
layer 6	$f_{ps} =$	279.4 ksi
layer 7	$f_{ps} =$	279.4 ksi
layer 8	$f_{ps} =$	279.4 ksi
layer 9	$f_{ps} =$	279.4 ksi
layer 10	$f_{ps} =$	279.4 ksi
layer 11	$f_{ps} =$	279.4 ksi
layer 12	$f_{ps} =$	279.4 ksi
layer 13	$f_{ps} =$	279.4 ksi
layer 14	$f_{ps} =$	279.4 ksi
nominal flexure resistance		
	a =	3.92 in
$M_r = \Phi M_n, \Phi = 1.00$	$\Phi M_n =$	9196.5 ft-kips
NEGATIVE MOMENT SECTION		
$M_u = 1.25DC + 1.5DW + 1.75(LL + IM)$	$M_u =$	-4837.2 ft-kips
	a =	0.20 in
	$\Phi M_n =$	5273.8 ft-kips

OK

OK

### Shear Design

CRITICAL SECTION AT 0.59			
$V_u = 1.25DC+1.5DW+1.75(LL+IM)$	$V_u =$	405.0 kips	
$M_u = 1.25DC+1.5DW+1.75(LL+IM)$	$M_u =$	-2684.4 ft-kips	
or			
$V_u = 1.25DC+1.5DW+1.75(LL+IM)$	$V_u =$	364.8 kips	
$M_u = 1.25DC+1.5DW+1.75(LL+IM)$	$M_u =$	-2877.0 ft-kips	
max shear	$V_u =$	405.0 kips	
max moment	$M_u =$	2877.0 ft-kips	
Shear depth	$d_v =$	73.19 in	
Applied factored normal force at the section	$N_u =$	0	
Angle of diagonal compressive stresses	$\theta =$	36.00 °	

### STRAIN IN FLEXURAL TENSION REINFORCEMENT

$$\epsilon_s = \frac{\frac{M_u}{d_v} + 0.5M_u + 0.5N_u \cot \theta - A_{ps}f_{ps}}{E_s A_s + E_p A_{ps}} \leq 0.002$$

	at midspan	at endspan
resultant compressive stress at centroid	$f_{pc} =$ 0.909 ksi	0.911 ksi
effective stress in prestressing strand after all losses		
layer 1	$f_{po} =$ 176.7 ksi	177.3 ksi
layer 2	$f_{po} =$ 176.7 ksi	177.3 ksi
layer 3	$f_{po} =$ 176.7 ksi	177.3 ksi
layer 4	$f_{po} =$ 176.7 ksi	177.3 ksi
layer 5	$f_{po} =$ 176.7 ksi	
layer 6	$f_{po} =$ 176.7 ksi	
layer 7	$f_{po} =$ 176.7 ksi	
layer 8	$f_{po} =$ 176.7 ksi	
layer 9	$f_{po} =$	177.3 ksi
layer 10	$f_{po} =$	177.3 ksi
layer 11	$f_{po} =$	177.3 ksi
layer 12	$f_{po} =$	177.3 ksi
layer 13	$f_{po} =$	177.3 ksi
layer 14	$f_{po} =$	177.3 ksi

strain in flexural tension

	at midspan	at endspan
layer 1	$\epsilon_x =$ 0.002000	0.002000
layer 2	$\epsilon_x =$ 0.002000	0.002000
layer 3	$\epsilon_x =$ 0.002000	0.002000
layer 4	$\epsilon_x =$ 0.002000	0.002000
layer 5	$\epsilon_x =$ 0.002000	
layer 6	$\epsilon_x =$ 0.002000	
layer 7	$\epsilon_x =$ 0.002000	
layer 8	$\epsilon_x =$ 0.002000	
layer 9	$\epsilon_x =$	0.002000
layer 10	$\epsilon_x =$	0.002000
layer 11	$\epsilon_x =$	0.002000
layer 12	$\epsilon_x =$	0.002000
layer 13	$\epsilon_x =$	0.002000
layer 14	$\epsilon_x =$	0.002000

### Deflection and Camber

	at midspan	at endspan
Deflection due to Prestressing Force at Transfer	$\Delta_p =$ 3.27 in	3.29 in
Deflection due to Beam Self-Weight at Transfer	$\Delta_{sw} =$ -1.49 in	
Deflection due to Beam Self-Weight at Erection	$\Delta_{sw} =$ -1.44 in	
Deflection due to Haunch and Deck	$\Delta_s =$ -1.95 in	
Deflection due to total self weight	$\Delta_{sw} =$ -0.11 in	
Total Deflection at transfer	$\Delta =$ 1.79 in	1.81 in
Total Deflection at erection	$\Delta =$ 3.24 in	3.27 in

### Deck Deflection (assuming 12" beam)

Deflection due to Deck Self-Weight	$\Delta_{sw} =$ -0.9835 in
Live load deflection limit = span/800	$=$ 0.18 in
Deflection due to live load and impact	$\Delta_L =$ -0.13 in

OK

**Location: Fire above Deck Between Girders**  
**Beam Design: 3/8" Strand**  
**Fire Exposure Status: 1/2 Hour**

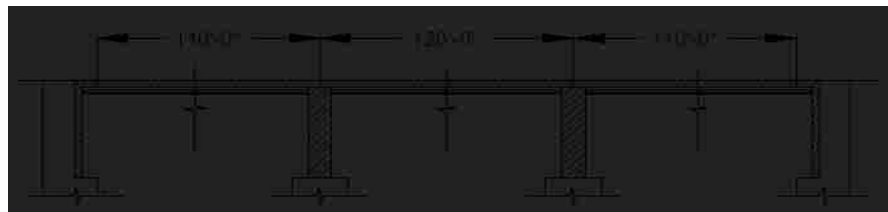
(PCI Bridge Design Manual Section 9.6)



**Material Properties**

CAST-IN-PLACE SLAB			
Actual Thickness	$t_{as} =$		8.0 in
Wearing Surface	$=$		0.5 in
Structural thickness = Actual - Wearing Surface	$t_s =$		7.5 in
Compressive Strength	$f_c =$		3.74 ksi
Unit Weight	$w_c =$		150.0 pcf
Stress factor of compression block	$\beta_1 =$		0.85

BEAMS: AASHTO-PCI, BT-72 BULB-TEE			
Strength at release	$f_{ci} =$		5.5 ksi
Strength at 28 days	$f_c =$		7 ksi
Unit Weight	$w_c =$		150.0 pcf
Overall Beam Length:			
@ end spans	$L =$		110 ft
@ center span	$L =$		119 ft
Design Spans:			
Non-composite beam @ end spans	$L =$		109 ft
Non-composite beam @ center span	$L =$		118 ft
Composite beam @ end spans	$L =$		110 ft
Composite beam @ center span	$L =$		120 ft
Beam Spacing	$S =$		12 ft



**PRESTRESSING STRANDS**

Diameter of single strand	d =	0.4 in
Area of single strand	A =	0.085 in <sup>2</sup>

Temperature of Layer	layer 1 (bottom)	T =	68.00 °F
	layer 2	T =	68.00 °F
	layer 3	T =	68.00 °F
	layer 4	T =	68.00 °F
	layer 5	T =	68.00 °F
	layer 6	T =	68.00 °F
	layer 7	T =	68.00 °F
	layer 8	T =	68.00 °F
	layer 9	T =	68.00 °F
	layer 10	T =	68.00 °F
	layer 11	T =	68.00 °F
	layer 12	T =	68.00 °F
	layer 13	T =	68.00 °F
	layer 14	T =	68.00 °F

Ultimate Strength initial = 284 ksi	layer 1 (bottom)	f <sub>pu</sub> =	284 ksi
	layer 2	f <sub>pu</sub> =	284 ksi
	layer 3	f <sub>pu</sub> =	284 ksi
	layer 4	f <sub>pu</sub> =	284 ksi
	layer 5	f <sub>pu</sub> =	284 ksi
	layer 6	f <sub>pu</sub> =	284 ksi
	layer 7	f <sub>pu</sub> =	284 ksi
	layer 8	f <sub>pu</sub> =	284 ksi
	layer 9	f <sub>pu</sub> =	284 ksi
	layer 10	f <sub>pu</sub> =	284 ksi
	layer 11	f <sub>pu</sub> =	284 ksi
	layer 12	f <sub>pu</sub> =	284 ksi
	layer 13	f <sub>pu</sub> =	284 ksi
	layer 14	f <sub>pu</sub> =	284 ksi

Yield Strength initial = 257 ksi	layer 1 (bottom)	f <sub>py</sub> =	257 ksi
	layer 2	f <sub>py</sub> =	257 ksi
	layer 3	f <sub>py</sub> =	257 ksi
	layer 4	f <sub>py</sub> =	257 ksi
	layer 5	f <sub>py</sub> =	257 ksi
	layer 6	f <sub>py</sub> =	257 ksi
	layer 7	f <sub>py</sub> =	257 ksi
	layer 8	f <sub>py</sub> =	257 ksi
	layer 9	f <sub>py</sub> =	257 ksi
	layer 10	f <sub>py</sub> =	257 ksi
	layer 11	f <sub>py</sub> =	257 ksi
	layer 12	f <sub>py</sub> =	257 ksi
	layer 13	f <sub>py</sub> =	257 ksi
	layer 14	f <sub>py</sub> =	257 ksi

<b>Stress Limits:</b> before transfer ≤ 0.75f <sub>pu</sub> (initial = 213.2)	layer 1 (bottom)	f <sub>pi</sub> =	213.2 ksi
	layer 2	f <sub>pi</sub> =	213.2 ksi
	layer 3	f <sub>pi</sub> =	213.2 ksi
	layer 4	f <sub>pi</sub> =	213.2 ksi
	layer 5	f <sub>pi</sub> =	213.2 ksi
	layer 6	f <sub>pi</sub> =	213.2 ksi
	layer 7	f <sub>pi</sub> =	213.2 ksi
	layer 8	f <sub>pi</sub> =	213.2 ksi
	layer 9	f <sub>pi</sub> =	213.2 ksi
	layer 10	f <sub>pi</sub> =	213.2 ksi
	layer 11	f <sub>pi</sub> =	213.2 ksi
	layer 12	f <sub>pi</sub> =	213.2 ksi
	layer 13	f <sub>pi</sub> =	213.2 ksi
	layer 14	f <sub>pi</sub> =	213.2 ksi

at service limit state (after all losses)  $\leq 0.80f_{py}$  (initial = 205.4)

layer 1 (bottom)	$f_{pe} =$	205.4 ksi
layer 2	$f_{pe} =$	205.4 ksi
layer 3	$f_{pe} =$	205.4 ksi
layer 4	$f_{pe} =$	205.4 ksi
layer 5	$f_{pe} =$	205.4 ksi
layer 6	$f_{pe} =$	205.4 ksi
layer 7	$f_{pe} =$	205.4 ksi
layer 8	$f_{pe} =$	205.4 ksi
layer 9	$f_{pe} =$	205.4 ksi
layer 10	$f_{pe} =$	205.4 ksi
layer 11	$f_{pe} =$	205.4 ksi
layer 12	$f_{pe} =$	205.4 ksi
layer 13	$f_{pe} =$	205.4 ksi
layer 14	$f_{pe} =$	205.4 ksi

Modulus of Elasticity

initial = 25898 ksi

layer 1 (bottom)	E =	25898.0 ksi
layer 2	E =	25898.0 ksi
layer 3	E =	25898.0 ksi
layer 4	E =	25898.0 ksi
layer 5	E =	25898.0 ksi
layer 6	E =	25898.0 ksi
layer 7	E =	25898.0 ksi
layer 8	E =	25898.0 ksi
layer 9	E =	25898.0 ksi
layer 10	E =	25898.0 ksi
layer 11	E =	25898.0 ksi
layer 12	E =	25898.0 ksi
layer 13	E =	25898.0 ksi
layer 14	E =	25898.0 ksi

#### MILD STEEL REINFORCING BARS AT ENDSPAN

Yield Strength

Layer 1 (Bottom)	$f_y =$	60.0 ksi	68.00 °F
Layer 2 (Top)	$f_y =$	58.2 ksi	550.00 °F

Modulus of Elasticity

Layer 1 (Bottom)	E =	29000.0 ksi
Layer 2 (Top)	E =	29000.0 ksi

Layer 1 (Bottom)

Area of steel at midspan (effective flange)	$A_{sm} =$	2.79 in <sup>2</sup>
Area of steel at endspan (effective flange)	$A_{se} =$	2.48 in <sup>2</sup>
Area of temperature and shrinkage steel (12" width)	$A_s =$	0.31 in <sup>2</sup>

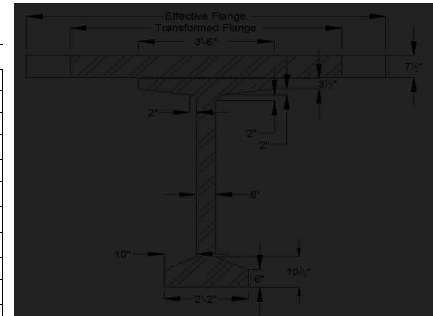
Layer 2 (Top)

Area of steel at midspan (effective flange)	$A_{sm} =$	12.6 in <sup>2</sup>
Area of steel at endspan (effective flange)	$A_{se} =$	12.4 in <sup>2</sup>
Area of temperature and shrinkage steel (12" width)	$A_s =$	0.2 in <sup>2</sup>

#### Cross-sectional Properties

##### NON-COMPOSITE BEAM

Area of cross-section of beam	A =	767.0 in <sup>2</sup>
Overall depth of beam	H =	72.0 in
Moment of Inertia	I =	539,947 in <sup>4</sup>
Distance from centroid to extreme <b>bottom</b> fiber	$y_b =$	36.6 in
Distance from centroid to extreme <b>top</b> fiber	$y_t =$	35.4 in
Section modulus for the extreme <b>bottom</b> fiber	$S_b =$	14915.0 in <sup>3</sup>
Section modulus for the extreme <b>top</b> fiber	$S_t =$	15421.0 in <sup>3</sup>
Weight	$W_t =$	799.0 plf
Modulus of Elasticity = $33000 \cdot (W_c^{1.5}) \cdot (\sqrt{f'_c})$		
cast-in-place concrete deck	$E_{cs} =$	3708 ksi
precast beam at release	$E_{ci} =$	4496 ksi
precast beam at service loads	$E_c =$	5072 ksi





### COMPOSITE BEAM

Effective Flange Width	$b_f =$	111.0 in	*min of three criteria
Modular Ratio = $E_{cs}/E_c$	$n =$	0.7309	
Transformed flange width	$=$	81.1 in	
Transformed flange area	$=$	608.5 in <sup>2</sup>	
Transformed haunch width	$=$	30.7 in	
Transformed haunch area	$=$	15.3 in <sup>2</sup>	

	Transformed Area	y <sub>b</sub>	Ay <sub>b</sub>	A(y <sub>b</sub> c-y <sub>b</sub> ) <sup>2</sup>	I	I + A(y <sub>b</sub> c-y <sub>b</sub> ) <sup>2</sup>
Beam	767.0 in <sup>2</sup>	36.60 in	28,072.2 in <sup>3</sup>	241,398 in <sup>4</sup>	539,947 in <sup>4</sup>	781,345 in <sup>4</sup>
Haunch	15.3 in <sup>2</sup>	72.25 in	1,109.0 in <sup>3</sup>	4,923 in <sup>4</sup>	0.33 in <sup>4</sup>	4,924 in <sup>4</sup>
Deck	608.5 in <sup>2</sup>	76.25 in	46,399.2 in <sup>3</sup>	292,099 in <sup>4</sup>	2,950 in <sup>4</sup>	295,049 in <sup>4</sup>
Total	1390.9 in <sup>2</sup>		75,580.5 in <sup>3</sup>			1,081,318 in <sup>4</sup>

Total area of Composite Section	$A_c =$	1391 in <sup>2</sup>
Overall Depth of the Composite Section	$h_c =$	80 in
Moment of Inertia	$I_c =$	1,081,318 in <sup>4</sup>
Distance from centroid to extreme <u>bottom</u> fiber of beam	$y_{bc} =$	54.34 in
Distance from centroid to extreme <u>top</u> fiber of beam	$y_{tb} =$	17.66 in
Distance from centroid to extreme <u>top</u> fiber of slab	$y_{tc} =$	25.66 in
Section modulus for the extreme <u>bottom</u> fiber of beam	$S_{bc} =$	19,898.9 in <sup>3</sup>
Section modulus for the extreme <u>top</u> fiber of beam	$S_{tb} =$	61,232.0 in <sup>3</sup>
Section modulus for the extreme <u>top</u> fiber slab	$S_{tc} =$	57,652.8 in <sup>3</sup>

### DECK (as 12" beam)

Reinforcing per 12"		at midspan	at beams
Layer 1 (Bottom)	$A_{s1} =$	0.3 in <sup>2</sup>	0.3 in <sup>2</sup>
Layer 2 (Top)	$A_{s2} =$	0.2 in <sup>2</sup>	0.2 in <sup>2</sup>

Modulus of Elasticity = $33000 \cdot (W_c \cdot 1.5)^{1.5} \cdot (\sqrt{f'_c})$	
cast-in-place concrete deck	$E_{cs} =$ 3708 ksi

Moment of Inertia	$I_g =$	324 in <sup>4</sup>	
Distance from centroid to extreme <u>bottom</u> fiber of deck	$y_b =$	3.44 in	
Distance from centroid to extreme <u>top</u> fiber of deck	$y_t =$	4.56 in	
Modulus of Rupture	$f_r =$	458.7 psi	
Cracking Moment	$M_{CR} =$	3.6 ft-kips	2.7 ft-kips
Max negative moment at loading stage	$M_a =$	16.9 ft-kips	21.1 ft-kips
Cracking Moment of Inertia	$I_{cr} =$	87 in <sup>4</sup>	87 in <sup>4</sup>
Effective Moment of Inertia	$I_e =$	90 in <sup>4</sup>	88 in <sup>4</sup>
Effective Moment of Inertia for Continuous Beam	$I_e =$	89 in <sup>4</sup>	

### Shear Forces and Bending Moments

#### DEAD LOADS

Beam self-weight	$W_{beam} =$	0.799 k/f
8 in. deck weight	$W_{deck} =$	1.200 k/f
1/2 in. haunch weight	$W_{haunch} =$	0.022 k/f

LRFD Specifications: Art. 4.6.2.2.1

Width of Deck Constant		OK
Number of beams is not less than four $N_b =$	4	OK
Roadway part of the overhang, $d_o \leq 3.0$ ft, $d_o =$	1.5	OK
Curvature in plans is less than $4^\circ =$	0	OK
Cross-section of the bridge is consistent with one of the cross sections given by LRFD specs		OK

Barrier and wearing surface loads are equally distributed among the 4 beams

Barrier Wt	$W_t =$	0.150 k/f
Dead load of future wearing surface	$DW =$	0.263 k/f

LIVE LOADS		
Fire truck live load front load (Point A)	$P_{live} =$	48.0 kips
Fire truck live load back load (Point B)	$P_{live} =$	22.0 kips
distance between two loads		19.2 ft
distance from nearest edge to point A	$x_a =$	59.0 ft
distance from nearest edge to point B	$x_b =$	39.8 ft
LRFD Specifications: Art. 4.6.2.2.1		
Width of Deck Constant		OK
Number of beams is not less than four $N_b =$	4	OK
Beams are parallel and approximately of the same stiffness		OK
Roadway part of the overhang, $d_o \leq 3.0$ ft, $d_o =$	1.5	OK
Curvature in plans is less than $4^\circ =$	0	OK

Barrier and wearing surface loads are equally distributed among the 4 beams

Bridge Type-- "k" (LRFD Table 4.6.2.2.1-1)		
Number of design lanes = $w/12$	=	3 lanes

**Distribution Factor for Bending Moment:**

Beams spacing	$S =$	12.0 ft
Depth of concrete slab	$t_s =$	7.5 in
Beam Span	$L =$	120.0 ft
Number of Beams	$N_b =$	4
Modular ratio between beam & deck materials	$n =$	1.3681
Longitudinal stiffness parameter	$K_y =$	2,388,355.43 in <sup>4</sup>

at center span:		
$DFM = 0.75 + \left(\frac{S}{9.5}\right)^{0.6} * \left(\frac{S}{L}\right)^{0.2} * \left(\frac{K_y}{12 * L * t_s^3}\right)^{0.1}$		
	DFM =	0.907 lanes/beam

0.905 Controls

one design lane loaded:		
$DFM = 0.75 + \left(\frac{S}{14}\right)^{0.6} * \left(\frac{S}{L}\right)^{0.3} * \left(\frac{K_y}{12 * L * t_s^3}\right)^{0.1}$		
	DFM =	0.615 lanes/beam

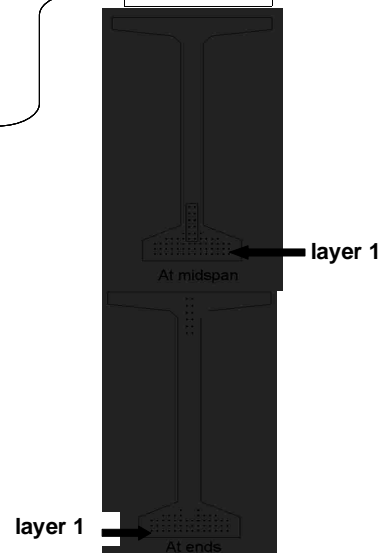
**Distribution Factor for Shear Force**

both end spans and center span:		
$DFV = 0.2 + \left(\frac{S}{12}\right) - \left(\frac{S}{35}\right)^2$		
	DFV =	1.082 lanes/beam

1.082 Controls

one design lane loaded:		
$DFV = 0.36 + \left(\frac{S}{25}\right)$		
	DFV =	0.840 lanes/beam

from bottom	At Midspan		At Ends	
	No. of	Distance from Bottom	No. of	Distance from Bottom
layer 1	14	2	14	2
layer 2	14	3.5	14	3.5
layer 3	14	5	14	5
layer 4	10	6.5	8	6.5
layer 5	4	8	2	8
layer 6	2	10	-	-
layer 7	2	12	-	-
layer 8	2	14	-	-
layer 9	2	16	2	60
layer 10	-	-	2	62
layer 11	-	-	2	64
layer 12	-	-	2	66
layer 13	-	-	2	68
layer 14	-	-	2	70
	64		64	
<b>Harped Strand Group (included in above totals)</b>				
layer 3	2	6		
layer 4	2	8		
layer 5	2	10		
layer 6	2	12		
layer 7	2	14		
layer 8	2	16		



distance from the center of gravity of strands to the bottom fiber of the beam = 7% of the beam depth  
strand eccentricity at midspan =  $(y_b - y_{bs})$

$y_{bs} =$	5.44 in
$e_c =$	31.16 in

### Prestress Losses

#### ELASTIC SHORTENING

assumed loss	=	6.00%
--------------	---	-------

Force per strand at transfer

layer 1	=	17.0 kips
layer 2	=	17.0 kips
layer 3	=	17.0 kips
layer 4	=	17.0 kips
layer 5	=	17.0 kips
layer 6	=	17.0 kips
layer 7	=	17.0 kips
layer 8	=	17.0 kips
layer 9	=	17.0 kips
layer 10	=	17.0 kips
layer 11	=	17.0 kips
layer 12	=	17.0 kips
layer 13	=	17.0 kips
layer 14	=	17.0 kips

Total prestressing force at release	$P_i =$	1088.0 kips	at midspan	1054.0 kips	at endspan
-------------------------------------	---------	-------------	------------	-------------	------------

Sum of concrete stresses at the center of gravity of prestressing tendons due to prestressing force at transfer and the self-weight of the member at sections of maximum moment

$f_{cgp} =$	2.412 ksi	2.307 ksi
-------------	-----------	-----------

Loss due to shortening

		at midspan	at endspan
layer 1	$\Delta f_{pES} =$	13.9 ksi	13.3 ksi
layer 2	$\Delta f_{pES} =$	13.9 ksi	13.3 ksi
layer 3	$\Delta f_{pES} =$	13.9 ksi	13.3 ksi
layer 4	$\Delta f_{pES} =$	13.9 ksi	13.3 ksi
layer 5	$\Delta f_{pES} =$	13.9 ksi	13.3 ksi
layer 6	$\Delta f_{pES} =$	13.9 ksi	
layer 7	$\Delta f_{pES} =$	13.9 ksi	
layer 8	$\Delta f_{pES} =$	13.9 ksi	
layer 9	$\Delta f_{pES} =$	13.9 ksi	13.3 ksi
layer 10	$\Delta f_{pES} =$		13.3 ksi
layer 11	$\Delta f_{pES} =$		13.3 ksi
layer 12	$\Delta f_{pES} =$		13.3 ksi
layer 13	$\Delta f_{pES} =$		13.3 ksi
layer 14	$\Delta f_{pES} =$		13.3 ksi

#### SHRINKAGE

Shrinkage =  $(17 - 0.15 \cdot \text{Relative Humidity})$

$\Delta f_{pSR} =$	6.5 ksi
--------------------	---------

← assume relative humidity = 70%

#### CREEP OF CONCRETE

Change of stresses at center of gravity of prestressing due to permanent loads except the loads acting at time of applying prestressing force, calculated at the same section as  $f_{cgp}$

$\Delta f_{cdp} =$	1.582 ksi	
--------------------	-----------	--

loss due to creep	$\Delta f_{PCR} =$	17.9 ksi	16.6 ksi
-------------------	--------------------	----------	----------

**RELAXATION OF PRESTRESSING STRANDS**

loss due to relaxation after transfer		at midspan	at endspan
layer 1	$\Delta f_{pR2} =$	2.9 ksi	2.9 ksi
layer 2	$\Delta f_{pR2} =$	2.9 ksi	2.9 ksi
layer 3	$\Delta f_{pR2} =$	2.9 ksi	2.9 ksi
layer 4	$\Delta f_{pR2} =$	2.9 ksi	2.9 ksi
layer 5	$\Delta f_{pR2} =$	2.9 ksi	2.9 ksi
layer 6	$\Delta f_{pR2} =$	2.9 ksi	
layer 7	$\Delta f_{pR2} =$	2.9 ksi	
layer 8	$\Delta f_{pR2} =$	2.9 ksi	
layer 9	$\Delta f_{pR2} =$	2.9 ksi	2.9 ksi
layer 10	$\Delta f_{pR2} =$		2.9 ksi
layer 11	$\Delta f_{pR2} =$		2.9 ksi
layer 12	$\Delta f_{pR2} =$		2.9 ksi
layer 13	$\Delta f_{pR2} =$		2.9 ksi
layer 14	$\Delta f_{pR2} =$		2.9 ksi

**TOTAL LOSSES AT TRANSFER**

total loss $\Delta f_{pES} = \Delta f_{pi}$		at midspan	at endspan
stress in tendons after transfer $f_{pt} = f_{pi} - \Delta f_{pi}$			
layer 1	$f_{pt} =$	199.3 ksi	199.9 ksi
layer 2	$f_{pt} =$	199.3 ksi	199.9 ksi
layer 3	$f_{pt} =$	199.3 ksi	199.9 ksi
layer 4	$f_{pt} =$	199.3 ksi	199.9 ksi
layer 5	$f_{pt} =$	199.3 ksi	199.9 ksi
layer 6	$f_{pt} =$	199.3 ksi	
layer 7	$f_{pt} =$	199.3 ksi	
layer 8	$f_{pt} =$	199.3 ksi	
layer 9	$f_{pt} =$	199.3 ksi	199.9 ksi
layer 10	$f_{pt} =$		199.9 ksi
layer 11	$f_{pt} =$		199.9 ksi
layer 12	$f_{pt} =$		199.9 ksi
layer 13	$f_{pt} =$		199.9 ksi
layer 14	$f_{pt} =$		199.9 ksi
force per strand = $f_{pi} \times \text{strand area}$		at midspan	at endspan
layer 1	=	16.9 kips	17.0 kips
layer 2	=	16.9 kips	17.0 kips
layer 3	=	16.9 kips	17.0 kips
layer 4	=	16.9 kips	17.0 kips
layer 5	=	16.9 kips	17.0 kips
layer 6	=	16.9 kips	
layer 7	=	16.9 kips	
layer 8	=	16.9 kips	
layer 9	=	16.9 kips	17.0 kips
layer 10	=		17.0 kips
layer 11	=		17.0 kips
layer 12	=		17.0 kips
layer 13	=		17.0 kips
layer 14	=		17.0 kips
Total prestressing force after transfer	$P_i =$	1047.8 kips	1054.0 kips
Initial loss = $(\Delta f_{pi}) / (f_{pi})$		at midspan	at endspan
layer 1	% =	6.5%	6.2%
layer 2	% =	6.5%	6.2%
layer 3	% =	6.5%	6.2%
layer 4	% =	6.5%	6.2%
layer 5	% =	6.5%	6.2%
layer 6	% =	6.5%	
layer 7	% =	6.5%	
layer 8	% =	6.5%	
layer 9	% =	6.5%	6.2%
layer 10	% =		6.2%
layer 11	% =		6.2%
layer 12	% =		6.2%
layer 13	% =		6.2%
layer 14	% =		6.2%

OK  
OK  
OK  
OK  
OK  
OK  
OK  
OK  
OK  
OK  
OK  
OK  
OK  
OK  
OK

**TOTAL LOSSES AT SERVICE LOADS**

Total Losses		at midspan	at endspan
layer 1	$\Delta f_{pT} =$	41.1 ksi	40.5 ksi
layer 2	$\Delta f_{pT} =$	41.1 ksi	40.5 ksi
layer 3	$\Delta f_{pT} =$	41.1 ksi	40.5 ksi
layer 4	$\Delta f_{pT} =$	41.1 ksi	40.5 ksi
layer 5	$\Delta f_{pT} =$	41.1 ksi	40.5 ksi
layer 6	$\Delta f_{pT} =$	41.1 ksi	
layer 7	$\Delta f_{pT} =$	41.1 ksi	
layer 8	$\Delta f_{pT} =$	41.1 ksi	
layer 9	$\Delta f_{pT} =$	41.1 ksi	40.5 ksi
layer 10	$\Delta f_{pT} =$		40.5 ksi
layer 11	$\Delta f_{pT} =$		40.5 ksi
layer 12	$\Delta f_{pT} =$		40.5 ksi
layer 13	$\Delta f_{pT} =$		40.5 ksi
layer 14	$\Delta f_{pT} =$		40.5 ksi

Stress in tendon after all losses =  $f_{pi} - \Delta f_{pt}$

		at midspan	at endspan
layer 1	$f_{pe} =$	172.0 ksi	172.6 ksi
layer 2	$f_{pe} =$	172.0 ksi	172.6 ksi
layer 3	$f_{pe} =$	172.0 ksi	172.6 ksi
layer 4	$f_{pe} =$	172.0 ksi	172.6 ksi
layer 5	$f_{pe} =$	172.0 ksi	172.6 ksi
layer 6	$f_{pe} =$	172.0 ksi	
layer 7	$f_{pe} =$	172.0 ksi	
layer 8	$f_{pe} =$	172.0 ksi	
layer 9	$f_{pe} =$	172.0 ksi	172.6 ksi
layer 10	$f_{pe} =$		172.6 ksi
layer 11	$f_{pe} =$		172.6 ksi
layer 12	$f_{pe} =$		172.6 ksi
layer 13	$f_{pe} =$		172.6 ksi
layer 14	$f_{pe} =$		172.6 ksi

check prestressing stress limit at service limit state:  $f_{pe} \leq 0.8 \cdot f_{py}$

layer 1	=	205.4 ksi
layer 2	=	205.4 ksi
layer 3	=	205.4 ksi
layer 4	=	205.4 ksi
layer 5	=	205.4 ksi
layer 6	=	205.4 ksi
layer 7	=	205.4 ksi
layer 8	=	205.4 ksi
layer 9	=	205.4 ksi
layer 10	=	205.4 ksi
layer 11	=	205.4 ksi
layer 12	=	205.4 ksi
layer 13	=	205.4 ksi
layer 14	=	205.4 ksi

OK  
OK  
OK  
OK  
OK  
OK  
OK  
OK  
OK  
OK  
OK  
OK  
OK  
OK

force per strand =  $f_{pe} \cdot \text{strand area}$

		at midspan	at endspan
layer 1	=	14.6 kips	14.7 kips
layer 2	=	14.6 kips	14.7 kips
layer 3	=	14.6 kips	14.7 kips
layer 4	=	14.6 kips	14.7 kips
layer 5	=	14.6 kips	14.7 kips
layer 6	=	14.6 kips	
layer 7	=	14.6 kips	
layer 8	=	14.6 kips	
layer 9	=	14.6 kips	14.7 kips
layer 10	=		14.7 kips
layer 11	=		14.7 kips
layer 12	=		14.7 kips
layer 13	=		14.7 kips
layer 14	=		14.7 kips

		at midspan	at endspan
Total prestressing force after all losses	$P_{pe} =$	935.8 kips	939.1 kips
Final losses, % = $(\Delta f_{pT})/(f_{pi})$			
layer 1	% =	19.3%	19.0%
layer 2	% =	19.3%	19.0%
layer 3	% =	19.3%	19.0%
layer 4	% =	19.3%	19.0%
layer 5	% =	19.3%	19.0%
layer 6	% =	19.3%	
layer 7	% =	19.3%	
layer 8	% =	19.3%	
layer 9	% =	19.3%	19.0%
layer 10	% =		19.0%
layer 11	% =		19.0%
layer 12	% =		19.0%
layer 13	% =		19.0%
layer 14	% =		19.0%
Average final losses, %	% =	19.3%	19.0%

### Stresses at Transfer

#### STRESS LIMITS FOR CONCRETE

Compression = $0.6f_{ci}$	$f_{ci} =$	3.300 ksi
Tension		
without bonded reinforcement = $-0.0948\sqrt{f_{ci}} \leq -0.2$	=	-0.200 ksi
with bonded auxiliary reinforcement = $-0.22\sqrt{f_{ci}}$	=	-0.016 ksi

#### STRESSES AT TRANSFER LENGTH SECTION

Transfer Length = $60 \times (\text{strand diameter})$	=	1.9 ft	} Calcs for eccentricity (see 9.6.7.2)
Bending moment at transfer length	$M_g =$	87.7 ft-kips	
center of 12 strands to top fiber of beam at the end	=	7.00 in	
center of 12 strands to bottom fiber of beam at the harp point	=	11.00 in	
center of gravity of 32 strands and top fiber of beam at transfer length	=	9.84 in	
center of gravity of 32 strands and bottom fiber of beam	=	3.98 in	
center of gravity of all strands and the bottom fiber of beam at transfer length	=	15.24 in	
center of gravity of all strands and the bottom fiber of beam at the end	=	15.30 in	
Eccentricity of the strand group at transfer length:	$e_n =$	21.36 in	}
Eccentricity at end of beam:	$e =$	21.30 in	

$$f_t = \frac{P_i}{A} - \frac{P_i e}{S_t} + \frac{M_g}{S_t}$$

$$f_b = \frac{P_i}{A} + \frac{P_i e}{S_b} - \frac{M_g}{S_b}$$

		at midspan	at endspan
Top stress at top fiber of beam	$f_t =$	-0.017 ksi	-0.017 ksi
Bottom stress at bottom fiber of the beam	$f_b =$	2.906 ksi	2.906 ksi

OK

OK

#### STRESSES AT HARP POINT

Bending moment due to beam weight at 0.3L	$M_g =$	1188.0 ft-kips	
Top stress at top fiber of beam	$f_t =$	0.173 ksi	0.169 ksi
Bottom stress at bottom fiber of the beam	$f_b =$	2.736 ksi	2.621 ksi

OK

OK

#### STRESSES AT MIDSPAN

Bending moment due to beam weight at 0.5L	$M_g =$	1414.3 ft-kips	
Top stress at top fiber of beam	$f_t =$	0.320 ksi	0.345 ksi
Bottom stress at bottom fiber of the beam	$f_b =$	2.554 ksi	2.438 ksi

OK

OK

### HOLD-DOWN FORCES

assume stress in strand before losses =  $0.8f_u$

layer 1	=	227.4 ksi
layer 2	=	227.4 ksi
layer 3	=	227.4 ksi
layer 4	=	227.4 ksi
layer 5	=	227.4 ksi
layer 6	=	227.4 ksi
layer 7	=	227.4 ksi
layer 8	=	227.4 ksi
layer 9	=	227.4 ksi
layer 10	=	227.4 ksi
layer 11	=	227.4 ksi
layer 12	=	227.4 ksi
layer 13	=	227.4 ksi
layer 14	=	227.4 ksi

prestress force per strand before any losses:

layer 1	=	19.3 kips
layer 2	=	19.3 kips
layer 3	=	19.3 kips
layer 4	=	19.3 kips
layer 5	=	19.3 kips
layer 6	=	19.3 kips
layer 7	=	19.3 kips
layer 8	=	19.3 kips
layer 9	=	19.3 kips
layer 10	=	19.3 kips
layer 11	=	19.3 kips
layer 12	=	19.3 kips
layer 13	=	19.3 kips
layer 14	=	19.3 kips
Harp Angle	$\psi$ =	7.2 °

Hold-down force/strand

layer 1	=	2.5 kips/strand
layer 2	=	2.5 kips/strand
layer 3	=	2.5 kips/strand
layer 4	=	2.5 kips/strand
layer 5	=	2.5 kips/strand
layer 6	=	2.5 kips/strand
layer 7	=	2.5 kips/strand
layer 8	=	2.5 kips/strand
layer 9	=	2.5 kips/strand
layer 10	=	2.5 kips/strand
layer 11	=	2.5 kips/strand
layer 12	=	2.5 kips/strand
layer 13	=	2.5 kips/strand
layer 14	=	2.5 kips/strand
Total hold-down force	=	30.45 kips

### Stresses at Service Loads

#### STRESS LIMITS FOR CONCRETE

##### Compression:

Due to permanent loads for load combination Service I

for the precast beam	=	3.150 ksi
for deck	=	1.683 ksi

Due to permanent and transient loads for load combination Service I

for the precast beam	=	4.200 ksi
for deck	=	2.244 ksi

##### Tension:

Load Combination Service III

for the precast beam	=	-0.016 ksi
----------------------	---	------------

STRESSES AT MIDSPAN			
Compression stresses at top fiber of beam		at midspan	at endspan
$f_s = \frac{F_{ps}}{A} - \frac{F_{ps}e}{S_t} + \frac{(M_D + M_L)}{S_t} + \frac{(M_{L2} + M_{L1})}{S_{L2}}$			
Due to permanent loads	$f_{i0} =$	2.106 ksi	2.103 ksi
$f_{s2} = \frac{F_{ps}}{A} - \frac{F_{ps}e}{S_t} + \frac{(M_D + M_L)}{S_t} + \frac{(M_{L2} + M_{L1})}{S_{L2}} + \frac{(M_{L3+1})}{S_{L3}}$			
Due to permanent loads and transient loads	$f_{i0} =$	2.520 ksi	2.518 ksi
Compression stresses at top fiber of deck		at midspan	at endspan
$f_{st} = \frac{(M_{L2} + M_{L1})}{S_{st}}$			
Due to permanent loads	$f_{ic} =$	0.042 ksi	0.042 ksi
$f_{st} = \frac{(M_{L2} + M_{L1} + M_{L3+1})}{S_{st}}$			
Due to permanent loads and transient loads	$f_{ic} =$	0.482 ksi	0.482 ksi
Tension stresses at top fiber of deck		at midspan	at endspan
$f_{st} = \frac{P_{pe}}{A} + \frac{F_{pe}e}{S_b} - \frac{(M_D + M_L)}{S_b} - \frac{(M_{L2} + M_{L1} + 0.8 * M_{L3+1})}{S_{st}}$			
Load Combination Service III	$f_b =$	-0.797 ksi	-0.785 ksi

OK

OK

OK

OK

OK

**Strength Limit State**

POSITIVE MOMENT SECTION		
$M_u = 1.25DC + 1.5DW + 1.75(LL + IM)$	$M_u =$	8381.5 ft-kips
effective length factor for compression members		
layer 1	k =	0.27
layer 2	k =	0.27
layer 3	k =	0.27
layer 4	k =	0.27
layer 5	k =	0.27
layer 6	k =	0.27
layer 7	k =	0.27
layer 8	k =	0.27
layer 9	k =	0.27
layer 10	k =	0.27
layer 11	k =	0.27
layer 12	k =	0.27
layer 13	k =	0.27
layer 14	k =	0.27
	c =	4.9 ft-kips
average stress in prestressing steel		
layer 1	$f_{ps} =$	279.1 ksi
layer 2	$f_{ps} =$	279.1 ksi
layer 3	$f_{ps} =$	279.1 ksi
layer 4	$f_{ps} =$	279.1 ksi
layer 5	$f_{ps} =$	279.1 ksi
layer 6	$f_{ps} =$	279.1 ksi
layer 7	$f_{ps} =$	279.1 ksi
layer 8	$f_{ps} =$	279.1 ksi
layer 9	$f_{ps} =$	279.1 ksi
layer 10	$f_{ps} =$	279.1 ksi
layer 11	$f_{ps} =$	279.1 ksi
layer 12	$f_{ps} =$	279.1 ksi
layer 13	$f_{ps} =$	279.1 ksi
layer 14	$f_{ps} =$	279.1 ksi
nominal flexure resistance		
	a =	4.18 in
$M_r = \Phi M_n, \Phi = 1.00$	$\Phi M_n =$	9168.8 ft-kips
NEGATIVE MOMENT SECTION		
$M_u = 1.25DC + 1.5DW + 1.75(LL + IM)$	$M_u =$	-4837.2 ft-kips
	a =	0.20 in
	$\Phi M_n =$	5144.4 ft-kips

OK

OK



### Shear Design

CRITICAL SECTION AT 0.59		
$V_u = 1.25DC + 1.5DW + 1.75(LL + IM)$	$V_u =$	405.0 kips
$M_u = 1.25DC + 1.5DW + 1.75(LL + IM)$	$M_u =$	-2684.4 ft-kips
or		
$V_u = 1.25DC + 1.5DW + 1.75(LL + IM)$	$V_u =$	364.8 kips
$M_u = 1.25DC + 1.5DW + 1.75(LL + IM)$	$M_u =$	-2877.0 ft-kips
max shear	$V_u =$	405.0 kips
max moment	$M_u =$	2877.0 ft-kips
Shear depth	$d_v =$	73.19 in
Applied factored normal force at the section	$N_u =$	0
Angle of diagonal compressive stresses	$\theta =$	36.00 °

### STRAIN IN FLEXURAL TENSION REINFORCEMENT

$$\epsilon_s = \frac{\frac{M_u}{d_v} + 0.5M_u + 0.5N_u \cot \theta - A_{ps}f_{ps}}{E_s A_s + E_p A_{ps}} \leq 0.002$$

	at midspan	at endspan	
resultant compressive stress at centroid	$f_{pc} =$	0.914 ksi	0.917 ksi
effective stress in prestressing strand after all losses			
layer 1	$f_{po} =$	176.7 ksi	177.3 ksi
layer 2	$f_{po} =$	176.7 ksi	177.3 ksi
layer 3	$f_{po} =$	176.7 ksi	177.3 ksi
layer 4	$f_{po} =$	176.7 ksi	177.3 ksi
layer 5	$f_{po} =$	176.7 ksi	
layer 6	$f_{po} =$	176.7 ksi	
layer 7	$f_{po} =$	176.7 ksi	
layer 8	$f_{po} =$	176.7 ksi	
layer 9	$f_{po} =$		177.3 ksi
layer 10	$f_{po} =$		177.3 ksi
layer 11	$f_{po} =$		177.3 ksi
layer 12	$f_{po} =$		177.3 ksi
layer 13	$f_{po} =$		177.3 ksi
layer 14	$f_{po} =$		177.3 ksi
strain in flexural tension		at midspan	at endspan
layer 1	$\epsilon_x =$	0.002000	0.002000
layer 2	$\epsilon_x =$	0.002000	0.002000
layer 3	$\epsilon_x =$	0.002000	0.002000
layer 4	$\epsilon_x =$	0.002000	0.002000
layer 5	$\epsilon_x =$	0.002000	
layer 6	$\epsilon_x =$	0.002000	
layer 7	$\epsilon_x =$	0.002000	
layer 8	$\epsilon_x =$	0.002000	
layer 9	$\epsilon_x =$		0.002000
layer 10	$\epsilon_x =$		0.002000
layer 11	$\epsilon_x =$		0.002000
layer 12	$\epsilon_x =$		0.002000
layer 13	$\epsilon_x =$		0.002000
layer 14	$\epsilon_x =$		0.002000

### Deflection and Camber

	at midspan	at endspan	
Deflection due to Prestressing Force at Transfer	$\Delta_p =$	3.27 in	3.29 in
Deflection due to Beam Self-Weight at Transfer	$\Delta_g =$	-1.49 in	
Deflection due to Beam Self-Weight at Erection	$\Delta_{g1} =$	-1.44 in	
Deflection due to Haunch and Deck	$\Delta_g =$	-1.95 in	

Deflection due to total self weight	$\Delta_{sw} =$	-0.11 in
-------------------------------------	-----------------	----------

Total Deflection at transfer	$\Delta =$	1.79 in	1.81 in
Total Deflection at erection	$\Delta =$	3.24 in	3.27 in

### Deck Deflection (assuming 12" beam)

Deflection due to Deck Self-Weight	$\Delta_g =$	-1.1006 in
Live load deflection limit = span/800	$=$	0.18 in
Deflection due to live load and impact	$\Delta_L =$	-0.21 in

OK

**Location: Fire above Deck Between Girders**  
**Beam Design: 3/8" Strand**  
**Fire Exposure Status: 1 Hour**

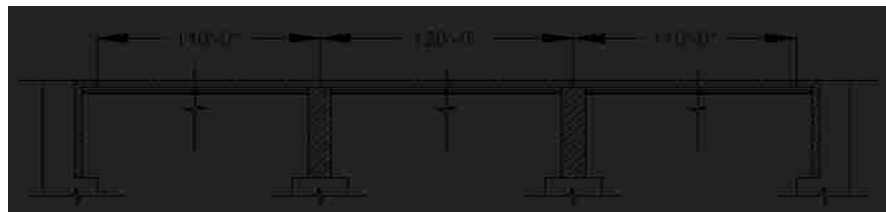
(PCI Bridge Design Manual Section 9.6)



**Material Properties**

CAST-IN-PLACE SLAB			
Actual Thickness	$t_{as} =$		8.0 in
Wearing Surface	$=$		0.5 in
Structural thickness = Actual - Wearing Surface	$t_s =$		7.5 in
Compressive Strength	$f_c =$		3.57 ksi
Unit Weight	$w_c =$		150.0 pcf
Stress factor of compression block	$\beta_1 =$		0.85

BEAMS: AASHTO-PCI, BT-72 BULB-TEE			
Strength at release	$f_{ci} =$		5.5 ksi
Strength at 28 days	$f_c =$		7 ksi
Unit Weight	$w_c =$		150.0 pcf
Overall Beam Length:			
@ end spans	$L =$		110 ft
@ center span	$L =$		119 ft
Design Spans:			
Non-composite beam @ end spans	$L =$		109 ft
Non-composite beam @ center span	$L =$		118 ft
Composite beam @ end spans	$L =$		110 ft
Composite beam @ center span	$L =$		120 ft
Beam Spacing	$S =$		12 ft



**PRESTRESSING STRANDS**

Diameter of single strand	d =	0.4 in
Area of single strand	A =	0.085 in <sup>2</sup>

Temperature of Layer	layer 1 (bottom)	T =	68.00 °F
	layer 2	T =	68.00 °F
	layer 3	T =	68.00 °F
	layer 4	T =	68.00 °F
	layer 5	T =	68.00 °F
	layer 6	T =	68.00 °F
	layer 7	T =	68.00 °F
	layer 8	T =	68.00 °F
	layer 9	T =	68.00 °F
	layer 10	T =	68.00 °F
	layer 11	T =	68.00 °F
	layer 12	T =	68.00 °F
	layer 13	T =	68.00 °F
	layer 14	T =	68.00 °F

Ultimate Strength initial = 284 ksi	layer 1 (bottom)	f <sub>pu</sub> =	284 ksi
	layer 2	f <sub>pu</sub> =	284 ksi
	layer 3	f <sub>pu</sub> =	284 ksi
	layer 4	f <sub>pu</sub> =	284 ksi
	layer 5	f <sub>pu</sub> =	284 ksi
	layer 6	f <sub>pu</sub> =	284 ksi
	layer 7	f <sub>pu</sub> =	284 ksi
	layer 8	f <sub>pu</sub> =	284 ksi
	layer 9	f <sub>pu</sub> =	284 ksi
	layer 10	f <sub>pu</sub> =	284 ksi
	layer 11	f <sub>pu</sub> =	284 ksi
	layer 12	f <sub>pu</sub> =	284 ksi
	layer 13	f <sub>pu</sub> =	284 ksi
	layer 14	f <sub>pu</sub> =	284 ksi

Yield Strength initial = 257 ksi	layer 1 (bottom)	f <sub>py</sub> =	257 ksi
	layer 2	f <sub>py</sub> =	257 ksi
	layer 3	f <sub>py</sub> =	257 ksi
	layer 4	f <sub>py</sub> =	257 ksi
	layer 5	f <sub>py</sub> =	257 ksi
	layer 6	f <sub>py</sub> =	257 ksi
	layer 7	f <sub>py</sub> =	257 ksi
	layer 8	f <sub>py</sub> =	257 ksi
	layer 9	f <sub>py</sub> =	257 ksi
	layer 10	f <sub>py</sub> =	257 ksi
	layer 11	f <sub>py</sub> =	257 ksi
	layer 12	f <sub>py</sub> =	257 ksi
	layer 13	f <sub>py</sub> =	257 ksi
	layer 14	f <sub>py</sub> =	257 ksi

<b>Stress Limits:</b> before transfer ≤ 0.75f <sub>pu</sub> (initial = 213.2)	layer 1 (bottom)	f <sub>pi</sub> =	213.2 ksi
	layer 2	f <sub>pi</sub> =	213.2 ksi
	layer 3	f <sub>pi</sub> =	213.2 ksi
	layer 4	f <sub>pi</sub> =	213.2 ksi
	layer 5	f <sub>pi</sub> =	213.2 ksi
	layer 6	f <sub>pi</sub> =	213.2 ksi
	layer 7	f <sub>pi</sub> =	213.2 ksi
	layer 8	f <sub>pi</sub> =	213.2 ksi
	layer 9	f <sub>pi</sub> =	213.2 ksi
	layer 10	f <sub>pi</sub> =	213.2 ksi
	layer 11	f <sub>pi</sub> =	213.2 ksi
	layer 12	f <sub>pi</sub> =	213.2 ksi
	layer 13	f <sub>pi</sub> =	213.2 ksi
	layer 14	f <sub>pi</sub> =	213.2 ksi

at service limit state (after all losses)  $\leq 0.80f_{py}$  (initial = 205.4)

layer 1 (bottom)	$f_{pe} =$	205.4 ksi
layer 2	$f_{pe} =$	205.4 ksi
layer 3	$f_{pe} =$	205.4 ksi
layer 4	$f_{pe} =$	205.4 ksi
layer 5	$f_{pe} =$	205.4 ksi
layer 6	$f_{pe} =$	205.4 ksi
layer 7	$f_{pe} =$	205.4 ksi
layer 8	$f_{pe} =$	205.4 ksi
layer 9	$f_{pe} =$	205.4 ksi
layer 10	$f_{pe} =$	205.4 ksi
layer 11	$f_{pe} =$	205.4 ksi
layer 12	$f_{pe} =$	205.4 ksi
layer 13	$f_{pe} =$	205.4 ksi
layer 14	$f_{pe} =$	205.4 ksi

Modulus of Elasticity

initial = 25898 ksi

layer 1 (bottom)	E =	25898.0 ksi
layer 2	E =	25898.0 ksi
layer 3	E =	25898.0 ksi
layer 4	E =	25898.0 ksi
layer 5	E =	25898.0 ksi
layer 6	E =	25898.0 ksi
layer 7	E =	25898.0 ksi
layer 8	E =	25898.0 ksi
layer 9	E =	25898.0 ksi
layer 10	E =	25898.0 ksi
layer 11	E =	25898.0 ksi
layer 12	E =	25898.0 ksi
layer 13	E =	25898.0 ksi
layer 14	E =	25898.0 ksi

### MILD STEEL REINFORCING BARS AT ENDSPAN

Yield Strength

Layer 1 (Bottom)	$f_y =$	60.0 ksi	68.00 °F
Layer 2 (Top)	$f_y =$	57.6 ksi	820.00 °F

Modulus of Elasticity

Layer 1 (Bottom)	E =	29000.0 ksi
Layer 2 (Top)	E =	29000.0 ksi

Layer 1 (Bottom)

Area of steel at midspan (effective flange)	$A_{sm} =$	2.79 in <sup>2</sup>
Area of steel at endspan (effective flange)	$A_{se} =$	2.48 in <sup>2</sup>
Area of temperature and shrinkage steel (12" width)	$A_s =$	0.31 in <sup>2</sup>

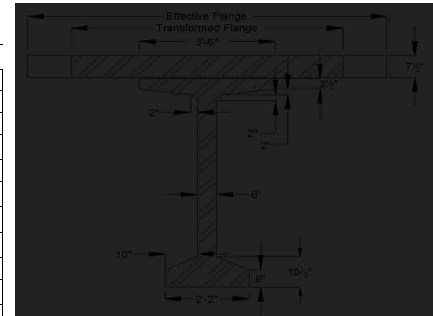
Layer 2 (Top)

Area of steel at midspan (effective flange)	$A_{sm} =$	12.6 in <sup>2</sup>
Area of steel at endspan (effective flange)	$A_{se} =$	12.4 in <sup>2</sup>
Area of temperature and shrinkage steel (12" width)	$A_s =$	0.2 in <sup>2</sup>

### Cross-sectional Properties

#### NON-COMPOSITE BEAM

Area of cross-section of beam	A =	767.0 in <sup>2</sup>
Overall depth of beam	H =	72.0 in
Moment of Inertia	I =	539,947 in <sup>4</sup>
Distance from centroid to extreme <b>bottom</b> fiber	$y_b =$	36.6 in
Distance from centroid to extreme <b>top</b> fiber	$y_t =$	35.4 in
Section modulus for the extreme <b>bottom</b> fiber	$S_b =$	14915.0 in <sup>3</sup>
Section modulus for the extreme <b>top</b> fiber	$S_t =$	15421.0 in <sup>3</sup>
Weight	$W_t =$	799.0 plf
Modulus of Elasticity = $33000 \cdot (W_c^{1.5}) \cdot (\sqrt{f'_c})$		
cast-in-place concrete deck	$E_{cs} =$	3622 ksi
precast beam at release	$E_{ci} =$	4496 ksi
precast beam at service loads	$E_c =$	5072 ksi



### COMPOSITE BEAM

Effective Flange Width	$b_f =$	111.0 in	*min of three criteria
Modular Ratio = $E_{cs}/E_c$	$n =$	0.7141	
Transformed flange width	$=$	79.3 in	
Transformed flange area	$=$	594.5 in <sup>2</sup>	
Transformed haunch width	$=$	30.0 in	
Transformed haunch area	$=$	15.0 in <sup>2</sup>	

	Transformed Area	y <sub>b</sub>	Ay <sub>b</sub>	A(y <sub>bc</sub> -y <sub>b</sub> ) <sup>2</sup>	I	I + A(y <sub>bc</sub> -y <sub>b</sub> ) <sup>2</sup>
Beam	767.0 in <sup>2</sup>	36.60 in	28,072.2 in <sup>3</sup>	235,253 in <sup>4</sup>	539,947 in <sup>4</sup>	775,200 in <sup>4</sup>
Haunch	15.0 in <sup>2</sup>	72.25 in	1,083.5 in <sup>3</sup>	4,933 in <sup>4</sup>	0.33 in <sup>4</sup>	4,933 in <sup>4</sup>
Deck	594.5 in <sup>2</sup>	76.25 in	45,332.4 in <sup>3</sup>	291,335 in <sup>4</sup>	2,950 in <sup>4</sup>	294,284 in <sup>4</sup>
Total	1376.5 in <sup>2</sup>		74,488.2 in <sup>3</sup>			1,074,417 in <sup>4</sup>

Total area of Composite Section	$A_c =$	1377 in <sup>2</sup>
Overall Depth of the Composite Section	$h_c =$	80 in
Moment of Inertia	$I_c =$	1,074,417 in <sup>4</sup>
Distance from centroid to extreme <u>bottom</u> fiber of beam	$y_{bc} =$	54.11 in
Distance from centroid to extreme <u>top</u> fiber of beam	$y_{tb} =$	17.89 in
Distance from centroid to extreme <u>top</u> fiber of slab	$y_{tc} =$	25.89 in
Section modulus for the extreme <u>bottom</u> fiber of beam	$S_{bc} =$	19,854.9 in <sup>3</sup>
Section modulus for the extreme <u>top</u> fiber of beam	$S_{tb} =$	60,068.2 in <sup>3</sup>
Section modulus for the extreme <u>top</u> fiber slab	$S_{tc} =$	58,118.2 in <sup>3</sup>

### DECK (as 12" beam)

Reinforcing per 12"		at midspan	at beams
Layer 1 (Bottom)	$A_s =$	0.3 in <sup>2</sup>	0.3 in <sup>2</sup>
Layer 2 (Top)	$A_s =$	0.2 in <sup>2</sup>	0.2 in <sup>2</sup>

Modulus of Elasticity = $33000 \cdot (W_c^{1.5}) \cdot (\sqrt{f'_c})$			
cast-in-place concrete deck	$E_{cs} =$	3622 ksi	
Moment of Inertia	$I_g =$	249 in <sup>4</sup>	
Distance from centroid to extreme <u>bottom</u> fiber of deck	$y_b =$	3.11 in	
Distance from centroid to extreme <u>top</u> fiber of deck	$y_t =$	4.89 in	
Modulus of Rupture	$f_r =$	448.1 psi	
Cracking Moment	$M_{CR} =$	3.0 ft-kips	1.9 ft-kips
Max negative moment at loading stage	$M_a =$	16.9 ft-kips	21.1 ft-kips
Cracking Moment of Inertia	$I_{cr} =$	87 in <sup>4</sup>	87 in <sup>4</sup>
Effective Moment of Inertia	$I_e =$	88 in <sup>4</sup>	87 in <sup>4</sup>
Effective Moment of Inertia for Continuous Beam	$I_e =$	88 in <sup>4</sup>	

### Shear Forces and Bending Moments

#### DEAD LOADS

Beam self-weight	$W_{beam} =$	0.799 k/f
8 in. deck weight	$W_{deck} =$	1.200 k/f
1/2 in. haunch weight	$W_{haunch} =$	0.022 k/f

LRFD Specifications: Art. 4.6.2.2.1

Width of Deck Constant		OK
Number of beams is not less than four $N_b =$	4	OK
Roadway part of the overhang, $d_o \leq 3.0$ ft, $d_o =$	1.5	OK
Curvature in plans is less than 4° =	0	OK
Cross-section of the bridge is consistent with one of the cross sections given by LRFD specs		OK

Barrier and wearing surface loads are equally distributed among the 4 beams

Barrier Wt	$W_t =$	0.150 k/f
Dead load of future wearing surface	$DW =$	0.263 k/f

LIVE LOADS		
Fire truck live load front load (Point A)	$P_{live} =$	48.0 kips
Fire truck live load back load (Point B)	$P_{live} =$	22.0 kips
distance between two loads		19.2 ft
distance from nearest edge to point A	$x_a =$	59.0 ft
distance from nearest edge to point B	$x_b =$	39.8 ft
LRFD Specifications: Art. 4.6.2.2.1		
Width of Deck Constant		OK
Number of beams is not less than four $N_b =$	4	OK
Beams are parallel and approximately of the same stiffness		OK
Roadway part of the overhang, $d_o \leq 3.0$ ft, $d_o =$	1.5	OK
Curvature in plans is less than $4^\circ =$	0	OK

Barrier and wearing surface loads are equally distributed among the 4 beams

Bridge Type-- "k" (LRFD Table 4.6.2.2.1-1)		
Number of design lanes = $w/12$	=	3 lanes

**Distribution Factor for Bending Moment:**

Beams spacing	$S =$	12.0 ft
Depth of concrete slab	$t_s =$	7.5 in
Beam Span	$L =$	120.0 ft
Number of Beams	$N_b =$	4
Modular ratio between beam & deck materials	$n =$	1.4003
Longitudinal stiffness parameter	$K_y =$	2,444,559.72 in <sup>4</sup>

at center span:		
$DFM = 0.75 + \left(\frac{S}{9.5}\right)^{0.6} * \left(\frac{S}{L}\right)^{0.2} * \left(\frac{K_y}{12 * L * t_s^3}\right)^{0.1}$		
DFM =		0.909 lanes/beam

0.905 Controls

one design lane loaded:		
$DFM = 0.75 + \left(\frac{S}{14}\right)^{0.6} * \left(\frac{S}{L}\right)^{0.3} * \left(\frac{K_y}{12 * L * t_s^3}\right)^{0.1}$		
DFM =		0.617 lanes/beam

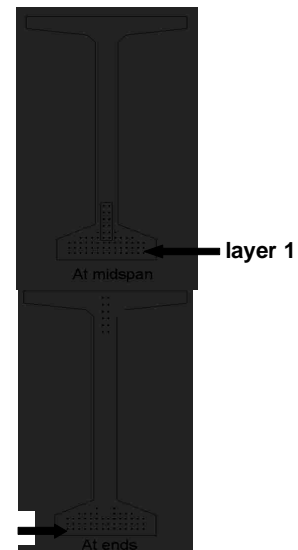
**Distribution Factor for Shear Force**

both end spans and center span:		
$DFV = 0.2 + \left(\frac{S}{12}\right) - \left(\frac{S}{35}\right)^2$		
DFV =		1.082 lanes/beam

1.082 Controls

one design lane loaded:		
$DFV = 0.36 + \left(\frac{S}{25}\right)$		
DFV =		0.840 lanes/beam

from bottom	At Midspan		At Ends	
	No. of	Distance from Bottom	No. of	Distance from Bottom
layer 1	14	2	14	2
layer 2	14	3.5	14	3.5
layer 3	14	5	14	5
layer 4	10	6.5	8	6.5
layer 5	4	8	2	8
layer 6	2	10	-	-
layer 7	2	12	-	-
layer 8	2	14	-	-
layer 9	2	16	2	60
layer 10	-	-	2	62
layer 11	-	-	2	64
layer 12	-	-	2	66
layer 13	-	-	2	68
layer 14	-	-	2	70
	64		64	
<b>Harped Strand Group (included in above totals)</b>				
layer 3	2	6		
layer 4	2	8		
layer 5	2	10		
layer 6	2	12		
layer 7	2	14		
layer 8	2	16		



distance from the center of gravity of strands to the bottom fiber of the beam = 7% of the beam depth  
strand eccentricity at midspan = ( $y_b - y_{bs}$ )

$y_{bs} =$	5.44 in
$e_c =$	31.16 in

### Prestress Losses

#### ELASTIC SHORTENING

assumed loss	=	6.00%
--------------	---	-------

Force per strand at transfer

layer 1	=	17.0 kips
layer 2	=	17.0 kips
layer 3	=	17.0 kips
layer 4	=	17.0 kips
layer 5	=	17.0 kips
layer 6	=	17.0 kips
layer 7	=	17.0 kips
layer 8	=	17.0 kips
layer 9	=	17.0 kips
layer 10	=	17.0 kips
layer 11	=	17.0 kips
layer 12	=	17.0 kips
layer 13	=	17.0 kips
layer 14	=	17.0 kips

Total prestressing force at release	$P_i =$	1088.0 kips	at midspan	1054.0 kips	at endspan
-------------------------------------	---------	-------------	------------	-------------	------------

Sum of concrete stresses at the center of gravity of prestressing tendons due to prestressing force at transfer and the self-weight of the member at sections of maximum moment

$f_{cgp} =$	2.412 ksi	2.307 ksi
-------------	-----------	-----------

Loss due to shortening

		at midspan	at endspan
layer 1	$\Delta f_{pES} =$	13.9 ksi	13.3 ksi
layer 2	$\Delta f_{pES} =$	13.9 ksi	13.3 ksi
layer 3	$\Delta f_{pES} =$	13.9 ksi	13.3 ksi
layer 4	$\Delta f_{pES} =$	13.9 ksi	13.3 ksi
layer 5	$\Delta f_{pES} =$	13.9 ksi	13.3 ksi
layer 6	$\Delta f_{pES} =$	13.9 ksi	
layer 7	$\Delta f_{pES} =$	13.9 ksi	
layer 8	$\Delta f_{pES} =$	13.9 ksi	
layer 9	$\Delta f_{pES} =$	13.9 ksi	13.3 ksi
layer 10	$\Delta f_{pES} =$		13.3 ksi
layer 11	$\Delta f_{pES} =$		13.3 ksi
layer 12	$\Delta f_{pES} =$		13.3 ksi
layer 13	$\Delta f_{pES} =$		13.3 ksi
layer 14	$\Delta f_{pES} =$		13.3 ksi

#### SHRINKAGE

Shrinkage =  $(17 - 0.15 \times \text{Relative Humidity})$

$\Delta f_{pSR} =$	6.5 ksi
--------------------	---------

← assume relative humidity = 70%

#### CREEP OF CONCRETE

Change of stresses at center of gravity of prestressing due to permanent loads except the loads acting at time of applying prestressing force, calculated at the same section as  $f_{cgp}$

$\Delta f_{cdp} =$	1.582 ksi	
--------------------	-----------	--

loss due to creep	$\Delta f_{PCR} =$	17.9 ksi	16.6 ksi
-------------------	--------------------	----------	----------

**RELAXATION OF PRESTRESSING STRANDS**

loss due to relaxation after transfer		at midspan	at endspan
layer 1	$\Delta f_{pR2} =$	2.9 ksi	2.9 ksi
layer 2	$\Delta f_{pR2} =$	2.9 ksi	2.9 ksi
layer 3	$\Delta f_{pR2} =$	2.9 ksi	2.9 ksi
layer 4	$\Delta f_{pR2} =$	2.9 ksi	2.9 ksi
layer 5	$\Delta f_{pR2} =$	2.9 ksi	2.9 ksi
layer 6	$\Delta f_{pR2} =$	2.9 ksi	
layer 7	$\Delta f_{pR2} =$	2.9 ksi	
layer 8	$\Delta f_{pR2} =$	2.9 ksi	
layer 9	$\Delta f_{pR2} =$	2.9 ksi	2.9 ksi
layer 10	$\Delta f_{pR2} =$		2.9 ksi
layer 11	$\Delta f_{pR2} =$		2.9 ksi
layer 12	$\Delta f_{pR2} =$		2.9 ksi
layer 13	$\Delta f_{pR2} =$		2.9 ksi
layer 14	$\Delta f_{pR2} =$		2.9 ksi

**TOTAL LOSSES AT TRANSFER**

total loss $\Delta f_{pES} = \Delta f_{pi}$		at midspan	at endspan
stress in tendons after transfer $f_{pt} = f_{pi} - \Delta f_{pi}$			
layer 1	$f_{pt} =$	199.3 ksi	199.9 ksi
layer 2	$f_{pt} =$	199.3 ksi	199.9 ksi
layer 3	$f_{pt} =$	199.3 ksi	199.9 ksi
layer 4	$f_{pt} =$	199.3 ksi	199.9 ksi
layer 5	$f_{pt} =$	199.3 ksi	199.9 ksi
layer 6	$f_{pt} =$	199.3 ksi	
layer 7	$f_{pt} =$	199.3 ksi	
layer 8	$f_{pt} =$	199.3 ksi	
layer 9	$f_{pt} =$	199.3 ksi	199.9 ksi
layer 10	$f_{pt} =$		199.9 ksi
layer 11	$f_{pt} =$		199.9 ksi
layer 12	$f_{pt} =$		199.9 ksi
layer 13	$f_{pt} =$		199.9 ksi
layer 14	$f_{pt} =$		199.9 ksi
force per strand = $f_{pi} \times$ strand area		at midspan	at endspan
layer 1	=	16.9 kips	17.0 kips
layer 2	=	16.9 kips	17.0 kips
layer 3	=	16.9 kips	17.0 kips
layer 4	=	16.9 kips	17.0 kips
layer 5	=	16.9 kips	17.0 kips
layer 6	=	16.9 kips	
layer 7	=	16.9 kips	
layer 8	=	16.9 kips	
layer 9	=	16.9 kips	17.0 kips
layer 10	=		17.0 kips
layer 11	=		17.0 kips
layer 12	=		17.0 kips
layer 13	=		17.0 kips
layer 14	=		17.0 kips
Total prestressing force after transfer	$P_i =$	1047.8 kips	1054.0 kips
Initial loss = $(\Delta f_{pi}) / (f_{pi})$		at midspan	at endspan
layer 1	% =	6.5%	6.2%
layer 2	% =	6.5%	6.2%
layer 3	% =	6.5%	6.2%
layer 4	% =	6.5%	6.2%
layer 5	% =	6.5%	6.2%
layer 6	% =	6.5%	
layer 7	% =	6.5%	
layer 8	% =	6.5%	
layer 9	% =	6.5%	6.2%
layer 10	% =		6.2%
layer 11	% =		6.2%
layer 12	% =		6.2%
layer 13	% =		6.2%
layer 14	% =		6.2%

OK  
OK  
OK  
OK  
OK  
OK  
OK  
OK  
OK  
OK  
OK  
OK  
OK  
OK



**TOTAL LOSSES AT SERVICE LOADS**

Total Losses		at midspan	at endspan
layer 1	$\Delta f_{pT} =$	41.1 ksi	40.5 ksi
layer 2	$\Delta f_{pT} =$	41.1 ksi	40.5 ksi
layer 3	$\Delta f_{pT} =$	41.1 ksi	40.5 ksi
layer 4	$\Delta f_{pT} =$	41.1 ksi	40.5 ksi
layer 5	$\Delta f_{pT} =$	41.1 ksi	40.5 ksi
layer 6	$\Delta f_{pT} =$	41.1 ksi	
layer 7	$\Delta f_{pT} =$	41.1 ksi	
layer 8	$\Delta f_{pT} =$	41.1 ksi	
layer 9	$\Delta f_{pT} =$	41.1 ksi	40.5 ksi
layer 10	$\Delta f_{pT} =$		40.5 ksi
layer 11	$\Delta f_{pT} =$		40.5 ksi
layer 12	$\Delta f_{pT} =$		40.5 ksi
layer 13	$\Delta f_{pT} =$		40.5 ksi
layer 14	$\Delta f_{pT} =$		40.5 ksi

Stress in tendon after all losses =  $f_{pi} - \Delta f_{pt}$

		at midspan	at endspan
layer 1	$f_{pe} =$	172.0 ksi	172.6 ksi
layer 2	$f_{pe} =$	172.0 ksi	172.6 ksi
layer 3	$f_{pe} =$	172.0 ksi	172.6 ksi
layer 4	$f_{pe} =$	172.0 ksi	172.6 ksi
layer 5	$f_{pe} =$	172.0 ksi	172.6 ksi
layer 6	$f_{pe} =$	172.0 ksi	
layer 7	$f_{pe} =$	172.0 ksi	
layer 8	$f_{pe} =$	172.0 ksi	
layer 9	$f_{pe} =$	172.0 ksi	172.6 ksi
layer 10	$f_{pe} =$		172.6 ksi
layer 11	$f_{pe} =$		172.6 ksi
layer 12	$f_{pe} =$		172.6 ksi
layer 13	$f_{pe} =$		172.6 ksi
layer 14	$f_{pe} =$		172.6 ksi

check prestressing stress limit at service limit state:  $f_{pe} \leq 0.8 \cdot f_{py}$

layer 1	=	205.4 ksi
layer 2	=	205.4 ksi
layer 3	=	205.4 ksi
layer 4	=	205.4 ksi
layer 5	=	205.4 ksi
layer 6	=	205.4 ksi
layer 7	=	205.4 ksi
layer 8	=	205.4 ksi
layer 9	=	205.4 ksi
layer 10	=	205.4 ksi
layer 11	=	205.4 ksi
layer 12	=	205.4 ksi
layer 13	=	205.4 ksi
layer 14	=	205.4 ksi

OK  
OK  
OK  
OK  
OK  
OK  
OK  
OK  
OK  
OK  
OK  
OK  
OK  
OK

force per strand =  $f_{pe} \cdot \text{strand area}$

		at midspan	at endspan
layer 1	=	14.6 kips	14.7 kips
layer 2	=	14.6 kips	14.7 kips
layer 3	=	14.6 kips	14.7 kips
layer 4	=	14.6 kips	14.7 kips
layer 5	=	14.6 kips	14.7 kips
layer 6	=	14.6 kips	
layer 7	=	14.6 kips	
layer 8	=	14.6 kips	
layer 9	=	14.6 kips	14.7 kips
layer 10	=		14.7 kips
layer 11	=		14.7 kips
layer 12	=		14.7 kips
layer 13	=		14.7 kips
layer 14	=		14.7 kips

		at midspan	at endspan
Total prestressing force after all losses	$P_{pe} =$	935.8 kips	939.1 kips
Final losses, % = $(\Delta f_{pT})/(f_{pi})$			
layer 1	% =	19.3%	19.0%
layer 2	% =	19.3%	19.0%
layer 3	% =	19.3%	19.0%
layer 4	% =	19.3%	19.0%
layer 5	% =	19.3%	19.0%
layer 6	% =	19.3%	
layer 7	% =	19.3%	
layer 8	% =	19.3%	
layer 9	% =	19.3%	19.0%
layer 10	% =		19.0%
layer 11	% =		19.0%
layer 12	% =		19.0%
layer 13	% =		19.0%
layer 14	% =		19.0%
Average final losses, %	% =	19.3%	19.0%

### Stresses at Transfer

#### STRESS LIMITS FOR CONCRETE

Compression = $0.6f_{ci}$	$f_{ci} =$	3.300 ksi
Tension		
without bonded reinforcement = $-0.0948\sqrt{f'_{ci}} \leq -0.2$	=	-0.200 ksi
with bonded auxiliary reinforcement = $-0.22\sqrt{f'_{ci}}$	=	-0.016 ksi

#### STRESSES AT TRANSFER LENGTH SECTION

Transfer Length = $60 \times (\text{strand diameter})$	=	1.9 ft	} Calcs for eccentricity (see 9.6.7.2)
Bending moment at transfer length	$M_g =$	87.7 ft-kips	
center of 12 strands to top fiber of beam at the end	=	7.00 in	
center of 12 strands to bottom fiber of beam at the harp point	=	11.00 in	
center of gravity of 32 strands and top fiber of beam at transfer length	=	9.84 in	
center of gravity of 32 strands and bottom fiber of beam	=	3.98 in	
center of gravity of all strands and the bottom fiber of beam at transfer length	=	15.24 in	
center of gravity of all strands and the bottom fiber of beam at the end	=	15.30 in	
Eccentricity of the strand group at transfer length:	$e_n =$	21.36 in	}
Eccentricity at end of beam:	$e =$	21.30 in	

$$f_t = \frac{P_i}{A} - \frac{P_i e}{S_t} + \frac{M_g}{S_t}$$

$$f_b = \frac{P_i}{A} + \frac{P_i e}{S_b} - \frac{M_g}{S_b}$$

		at midspan	at endspan	
Top stress at top fiber of beam	$f_t =$	-0.017 ksi	-0.017 ksi	OK
Bottom stress at bottom fiber of the beam	$f_b =$	2.906 ksi	2.906 ksi	OK

#### STRESSES AT HARP POINT

Bending moment due to beam weight at 0.3L	$M_g =$	1188.0 ft-kips		
Top stress at top fiber of beam	$f_t =$	0.173 ksi	0.169 ksi	OK
Bottom stress at bottom fiber of the beam	$f_b =$	2.736 ksi	2.621 ksi	OK

#### STRESSES AT MIDSPAN

Bending moment due to beam weight at 0.5L	$M_g =$	1414.3 ft-kips		
Top stress at top fiber of beam	$f_t =$	0.320 ksi	0.345 ksi	OK
Bottom stress at bottom fiber of the beam	$f_b =$	2.554 ksi	2.438 ksi	OK

### HOLD-DOWN FORCES

assume stress in strand before losses =  $0.8f_u$

layer 1	=	227.4 ksi
layer 2	=	227.4 ksi
layer 3	=	227.4 ksi
layer 4	=	227.4 ksi
layer 5	=	227.4 ksi
layer 6	=	227.4 ksi
layer 7	=	227.4 ksi
layer 8	=	227.4 ksi
layer 9	=	227.4 ksi
layer 10	=	227.4 ksi
layer 11	=	227.4 ksi
layer 12	=	227.4 ksi
layer 13	=	227.4 ksi
layer 14	=	227.4 ksi

prestress force per strand before any losses:

layer 1	=	19.3 kips
layer 2	=	19.3 kips
layer 3	=	19.3 kips
layer 4	=	19.3 kips
layer 5	=	19.3 kips
layer 6	=	19.3 kips
layer 7	=	19.3 kips
layer 8	=	19.3 kips
layer 9	=	19.3 kips
layer 10	=	19.3 kips
layer 11	=	19.3 kips
layer 12	=	19.3 kips
layer 13	=	19.3 kips
layer 14	=	19.3 kips
Harp Angle	$\psi$ =	7.2 °

Hold-down force/strand

layer 1	=	2.5 kips/strand
layer 2	=	2.5 kips/strand
layer 3	=	2.5 kips/strand
layer 4	=	2.5 kips/strand
layer 5	=	2.5 kips/strand
layer 6	=	2.5 kips/strand
layer 7	=	2.5 kips/strand
layer 8	=	2.5 kips/strand
layer 9	=	2.5 kips/strand
layer 10	=	2.5 kips/strand
layer 11	=	2.5 kips/strand
layer 12	=	2.5 kips/strand
layer 13	=	2.5 kips/strand
layer 14	=	2.5 kips/strand
Total hold-down force	=	30.45 kips

### Stresses at Service Loads

#### STRESS LIMITS FOR CONCRETE

##### Compression:

Due to permanent loads for load combination Service I

for the precast beam	=	3.150 ksi
for deck	=	1.607 ksi

Due to permanent and transient loads for load combination Service I

for the precast beam	=	4.200 ksi
for deck	=	2.142 ksi

##### Tension:

Load Combination Service III

for the precast beam	=	-0.016 ksi
----------------------	---	------------

STRESSES AT MIDSPAN			
Compression stresses at top fiber of beam		at midspan	at endspan
$f_s = \frac{F_{ps}}{A} - \frac{F_{ps}e}{S_t} + \frac{(M_D + M_J)}{S_t} + \frac{(M_{L1} + M_{L2})}{S_{L1}}$			
Due to permanent loads	$f_{ig} =$	2.106 ksi	2.104 ksi
$f_{s1} = \frac{F_{ps}}{A} - \frac{F_{ps}e}{S_t} + \frac{(M_D + M_J)}{S_t} + \frac{(M_{L1} + M_{L2})}{S_{L1}} + \frac{(M_{L3})}{S_{L2}}$			
Due to permanent loads and transient loads	$f_{ig} =$	2.529 ksi	2.527 ksi
Compression stresses at top fiber of deck		at midspan	at endspan
$f_{st} = \frac{(M_{L1} + M_{L2})}{S_{st}}$			
Due to permanent loads	$f_{ic} =$	0.042 ksi	0.042 ksi
$f_{st} = \frac{(M_{L1} + M_{L2} + M_{L3})}{S_{st}}$			
Due to permanent loads and transient loads	$f_{ic} =$	0.478 ksi	0.478 ksi
Tension stresses at top fiber of deck		at midspan	at endspan
$f_{st} = \frac{P_{pe}}{A} + \frac{F_{ps}e}{S_b} - \frac{(M_D + M_J)}{S_b} - \frac{(M_{L1} + M_{L2} + 0.8 \cdot M_{L3})}{S_{st}}$			
Load Combination Service III	$f_b =$	-0.799 ksi	-0.788 ksi

OK

OK

OK

OK

OK

**Strength Limit State**

POSITIVE MOMENT SECTION		
$M_u = 1.25DC + 1.5DW + 1.75(LL + IM)$	$M_u =$	8381.5 ft-kips
effective length factor for compression members		
layer 1	k =	0.27
layer 2	k =	0.27
layer 3	k =	0.27
layer 4	k =	0.27
layer 5	k =	0.27
layer 6	k =	0.27
layer 7	k =	0.27
layer 8	k =	0.27
layer 9	k =	0.27
layer 10	k =	0.27
layer 11	k =	0.27
layer 12	k =	0.27
layer 13	k =	0.27
layer 14	k =	0.27
	c =	5.2 ft-kips
average stress in prestressing steel		
layer 1	$f_{ps} =$	278.8 ksi
layer 2	$f_{ps} =$	278.8 ksi
layer 3	$f_{ps} =$	278.8 ksi
layer 4	$f_{ps} =$	278.8 ksi
layer 5	$f_{ps} =$	278.8 ksi
layer 6	$f_{ps} =$	278.8 ksi
layer 7	$f_{ps} =$	278.8 ksi
layer 8	$f_{ps} =$	278.8 ksi
layer 9	$f_{ps} =$	278.8 ksi
layer 10	$f_{ps} =$	278.8 ksi
layer 11	$f_{ps} =$	278.8 ksi
layer 12	$f_{ps} =$	278.8 ksi
layer 13	$f_{ps} =$	278.8 ksi
layer 14	$f_{ps} =$	278.8 ksi
nominal flexure resistance		
	a =	4.38 in
$M_r = \Phi M_n, \Phi = 1.00$	$\Phi M_n =$	9148.6 ft-kips
NEGATIVE MOMENT SECTION		
$M_u = 1.25DC + 1.5DW + 1.75(LL + IM)$	$M_u =$	-4837.2 ft-kips
	a =	0.19 in
	$\Phi M_n =$	5101.2 ft-kips

OK

OK

### Shear Design

CRITICAL SECTION AT 0.59		
$V_u = 1.25DC+1.5DW+1.75(LL+IM)$	$V_u =$	405.0 kips
$M_u = 1.25DC+1.5DW+1.75(LL+IM)$	$M_u =$	-2684.4 ft-kips
or		
$V_u = 1.25DC+1.5DW+1.75(LL+IM)$	$V_u =$	364.8 kips
$M_u = 1.25DC+1.5DW+1.75(LL+IM)$	$M_u =$	-2877.0 ft-kips
max shear	$V_u =$	405.0 kips
max moment	$M_u =$	2877.0 ft-kips
Shear depth	$d_v =$	73.19 in
Applied factored normal force at the section	$N_u =$	0
Angle of diagonal compressive stresses	$\theta =$	36.00 °

### STRAIN IN FLEXURAL TENSION REINFORCEMENT

$$\epsilon_s = \frac{\frac{M_u}{d_v} + 0.5M_u + 0.5N_u \cot \theta - A_{ps}f_{ps}}{E_s A_s + E_p A_{ps}} \leq 0.002$$

	at midspan	at endspan
resultant compressive stress at centroid	$f_{pc} =$	0.918 ksi
effective stress in prestressing strand after all losses		
layer 1	$f_{po} =$	176.7 ksi
layer 2	$f_{po} =$	176.7 ksi
layer 3	$f_{po} =$	176.7 ksi
layer 4	$f_{po} =$	176.7 ksi
layer 5	$f_{po} =$	176.7 ksi
layer 6	$f_{po} =$	176.7 ksi
layer 7	$f_{po} =$	176.7 ksi
layer 8	$f_{po} =$	176.7 ksi
layer 9	$f_{po} =$	177.3 ksi
layer 10	$f_{po} =$	177.3 ksi
layer 11	$f_{po} =$	177.3 ksi
layer 12	$f_{po} =$	177.3 ksi
layer 13	$f_{po} =$	177.3 ksi
layer 14	$f_{po} =$	177.3 ksi

strain in flexural tension

	at midspan	at endspan
layer 1	$\epsilon_x =$	0.002000
layer 2	$\epsilon_x =$	0.002000
layer 3	$\epsilon_x =$	0.002000
layer 4	$\epsilon_x =$	0.002000
layer 5	$\epsilon_x =$	0.002000
layer 6	$\epsilon_x =$	0.002000
layer 7	$\epsilon_x =$	0.002000
layer 8	$\epsilon_x =$	0.002000
layer 9	$\epsilon_x =$	0.002000
layer 10	$\epsilon_x =$	0.002000
layer 11	$\epsilon_x =$	0.002000
layer 12	$\epsilon_x =$	0.002000
layer 13	$\epsilon_x =$	0.002000
layer 14	$\epsilon_x =$	0.002000

### Deflection and Camber

	at midspan	at endspan
Deflection due to Prestressing Force at Transfer	$\Delta_p =$	3.27 in
Deflection due to Beam Self-Weight at Transfer	$\Delta_g =$	-1.49 in
Deflection due to Beam Self-Weight at Erection	$\Delta_g =$	-1.44 in
Deflection due to Haunch and Deck	$\Delta_g =$	-1.95 in
Deflection due to total self weight	$\Delta_{sw} =$	-0.11 in
Total Deflection at transfer	$\Delta =$	1.79 in
Total Deflection at erection	$\Delta =$	-1.53 in

### Deck Deflection (assuming 12" beam)

Deflection due to Deck Self-Weight	$\Delta_g =$	-1.1381 in
Live load deflection limit = span/800	$=$	0.18 in
Deflection due to live load and impact	$\Delta_L =$	-0.28 in

OK

**Location: Fire above Deck Between Girders**  
**Beam Design: 3/8" Strand**  
**Fire Exposure Status: 1-1/2 Hour**

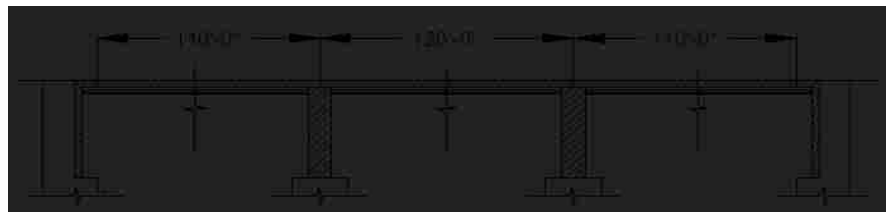
(PCI Bridge Design Manual Section 9.6)



**Material Properties**

CAST-IN-PLACE SLAB			
Actual Thickness	$t_{as} =$		8.0 in
Wearing Surface	$=$		0.5 in
Structural thickness = Actual - Wearing Surface	$t_s =$		7.5 in
Compressive Strength	$f_c =$		3.39 ksi
Unit Weight	$w_c =$		150.0 pcf
Stress factor of compression block	$\beta_1 =$		0.85

BEAMS: AASHTO-PCI, BT-72 BULB-TEE			
Strength at release	$f_{ci} =$		5.5 ksi
Strength at 28 days	$f_c =$		7 ksi
Unit Weight	$w_c =$		150.0 pcf
Overall Beam Length:			
@ end spans	$L =$		110 ft
@ center span	$L =$		119 ft
Design Spans:			
Non-composite beam @ end spans	$L =$		109 ft
Non-composite beam @ center span	$L =$		118 ft
Composite beam @ end spans	$L =$		110 ft
Composite beam @ center span	$L =$		120 ft
Beam Spacing	$S =$		12 ft



**PRESTRESSING STRANDS**

Diameter of single strand	d =	0.4 in
Area of single strand	A =	0.085 in <sup>2</sup>
Temperature of Layer		
	layer 1 (bottom)	T = 68.00 °F
	layer 2	T = 68.00 °F
	layer 3	T = 68.00 °F
	layer 4	T = 68.00 °F
	layer 5	T = 68.00 °F
	layer 6	T = 68.00 °F
	layer 7	T = 68.00 °F
	layer 8	T = 68.00 °F
	layer 9	T = 68.00 °F
	layer 10	T = 68.00 °F
	layer 11	T = 68.00 °F
	layer 12	T = 68.00 °F
	layer 13	T = 68.00 °F
	layer 14	T = 68.00 °F
Ultimate Strength		
initial = 284 ksi		
	layer 1 (bottom)	f <sub>pu</sub> = 284 ksi
	layer 2	f <sub>pu</sub> = 284 ksi
	layer 3	f <sub>pu</sub> = 284 ksi
	layer 4	f <sub>pu</sub> = 284 ksi
	layer 5	f <sub>pu</sub> = 284 ksi
	layer 6	f <sub>pu</sub> = 284 ksi
	layer 7	f <sub>pu</sub> = 284 ksi
	layer 8	f <sub>pu</sub> = 284 ksi
	layer 9	f <sub>pu</sub> = 284 ksi
	layer 10	f <sub>pu</sub> = 284 ksi
	layer 11	f <sub>pu</sub> = 284 ksi
	layer 12	f <sub>pu</sub> = 284 ksi
	layer 13	f <sub>pu</sub> = 284 ksi
	layer 14	f <sub>pu</sub> = 284 ksi
Yield Strength		
initial = 257 ksi		
	layer 1 (bottom)	f <sub>py</sub> = 257 ksi
	layer 2	f <sub>py</sub> = 257 ksi
	layer 3	f <sub>py</sub> = 257 ksi
	layer 4	f <sub>py</sub> = 257 ksi
	layer 5	f <sub>py</sub> = 257 ksi
	layer 6	f <sub>py</sub> = 257 ksi
	layer 7	f <sub>py</sub> = 257 ksi
	layer 8	f <sub>py</sub> = 257 ksi
	layer 9	f <sub>py</sub> = 257 ksi
	layer 10	f <sub>py</sub> = 257 ksi
	layer 11	f <sub>py</sub> = 257 ksi
	layer 12	f <sub>py</sub> = 257 ksi
	layer 13	f <sub>py</sub> = 257 ksi
	layer 14	f <sub>py</sub> = 257 ksi
<b>Stress Limits:</b>		
before transfer ≤ 0.75f <sub>pu</sub> (initial = 213.2)		
	layer 1 (bottom)	f <sub>pi</sub> = 213.2 ksi
	layer 2	f <sub>pi</sub> = 213.2 ksi
	layer 3	f <sub>pi</sub> = 213.2 ksi
	layer 4	f <sub>pi</sub> = 213.2 ksi
	layer 5	f <sub>pi</sub> = 213.2 ksi
	layer 6	f <sub>pi</sub> = 213.2 ksi
	layer 7	f <sub>pi</sub> = 213.2 ksi
	layer 8	f <sub>pi</sub> = 213.2 ksi
	layer 9	f <sub>pi</sub> = 213.2 ksi
	layer 10	f <sub>pi</sub> = 213.2 ksi
	layer 11	f <sub>pi</sub> = 213.2 ksi
	layer 12	f <sub>pi</sub> = 213.2 ksi
	layer 13	f <sub>pi</sub> = 213.2 ksi
	layer 14	f <sub>pi</sub> = 213.2 ksi

at service limit state (after all losses)  $\leq 0.80f_{py}$  (initial = 205.4)

layer 1 (bottom)	$f_{pe} =$	205.4 ksi
layer 2	$f_{pe} =$	205.4 ksi
layer 3	$f_{pe} =$	205.4 ksi
layer 4	$f_{pe} =$	205.4 ksi
layer 5	$f_{pe} =$	205.4 ksi
layer 6	$f_{pe} =$	205.4 ksi
layer 7	$f_{pe} =$	205.4 ksi
layer 8	$f_{pe} =$	205.4 ksi
layer 9	$f_{pe} =$	205.4 ksi
layer 10	$f_{pe} =$	205.4 ksi
layer 11	$f_{pe} =$	205.4 ksi
layer 12	$f_{pe} =$	205.4 ksi
layer 13	$f_{pe} =$	205.4 ksi
layer 14	$f_{pe} =$	205.4 ksi

Modulus of Elasticity

initial = 25898 ksi

layer 1 (bottom)	E =	25898.0 ksi
layer 2	E =	25898.0 ksi
layer 3	E =	25898.0 ksi
layer 4	E =	25898.0 ksi
layer 5	E =	25898.0 ksi
layer 6	E =	25898.0 ksi
layer 7	E =	25898.0 ksi
layer 8	E =	25898.0 ksi
layer 9	E =	25898.0 ksi
layer 10	E =	25898.0 ksi
layer 11	E =	25898.0 ksi
layer 12	E =	25898.0 ksi
layer 13	E =	25898.0 ksi
layer 14	E =	25898.0 ksi

#### MILD STEEL REINFORCING BARS AT ENDSPAN

Yield Strength

Layer 1 (Bottom)	$f_y =$	60.0 ksi	68.00 °F
Layer 2 (Top)	$f_y =$	55.4 ksi	1010.00 °F

Modulus of Elasticity

Layer 1 (Bottom)	E =	29000.0 ksi
Layer 2 (Top)	E =	29000.0 ksi

Layer 1 (Bottom)

Area of steel at midspan (effective flange)	$A_{sm} =$	2.79 in <sup>2</sup>
Area of steel at endspan (effective flange)	$A_{se} =$	2.48 in <sup>2</sup>
Area of temperature and shrinkage steel (12" width)	$A_s =$	0.31 in <sup>2</sup>

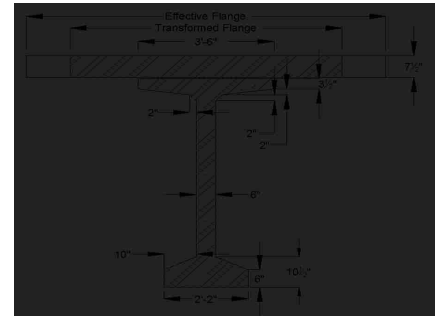
Layer 2 (Top)

Area of steel at midspan (effective flange)	$A_{sm} =$	12.6 in <sup>2</sup>
Area of steel at endspan (effective flange)	$A_{se} =$	12.4 in <sup>2</sup>
Area of temperature and shrinkage steel (12" width)	$A_s =$	0.2 in <sup>2</sup>

#### Cross-sectional Properties

##### NON-COMPOSITE BEAM

Area of cross-section of beam	A =	767.0 in <sup>2</sup>
Overall depth of beam	H =	72.0 in
Moment of Inertia	I =	539,947 in <sup>4</sup>
Distance from centroid to extreme <b>bottom</b> fiber	$y_b =$	36.6 in
Distance from centroid to extreme <b>top</b> fiber	$y_t =$	35.4 in
Section modulus for the extreme <b>bottom</b> fiber	$S_b =$	14915.0 in <sup>3</sup>
Section modulus for the extreme <b>top</b> fiber	$S_t =$	15421.0 in <sup>3</sup>
Weight	$W_t =$	799.0 plf
Modulus of Elasticity = $33000 \cdot (W_c^{1.5}) \cdot (\sqrt{f'_c})$		
cast-in-place concrete deck	$E_{cs} =$	3530 ksi
precast beam at release	$E_{ci} =$	4496 ksi
precast beam at service loads	$E_c =$	5072 ksi





### COMPOSITE BEAM

Effective Flange Width	$b_f =$	111.0 in	*min of three criteria
Modular Ratio = $E_{cs}/E_c$	$n =$	0.6959	
Transformed flange width	$=$	77.2 in	
Transformed flange area	$=$	579.3 in <sup>2</sup>	
Transformed haunch width	$=$	29.2 in	
Transformed haunch area	$=$	14.6 in <sup>2</sup>	

	Transformed Area	y <sub>b</sub>	Ay <sub>b</sub>	A(y <sub>bc</sub> -y <sub>b</sub> ) <sup>2</sup>	I	I + A(y <sub>bc</sub> -y <sub>b</sub> ) <sup>2</sup>
Beam	767.0 in <sup>2</sup>	36.60 in	28,072.2 in <sup>3</sup>	228,530 in <sup>4</sup>	539,947 in <sup>4</sup>	768,477 in <sup>4</sup>
Haunch	14.6 in <sup>2</sup>	72.25 in	1,055.9 in <sup>3</sup>	4,942 in <sup>4</sup>	0.33 in <sup>4</sup>	4,942 in <sup>4</sup>
Deck	579.3 in <sup>2</sup>	76.25 in	44,174.8 in <sup>3</sup>	290,397 in <sup>4</sup>	2,950 in <sup>4</sup>	293,346 in <sup>4</sup>
Total	1361.0 in <sup>2</sup>		73,302.9 in <sup>3</sup>			1,066,765 in <sup>4</sup>

Total area of Composite Section	$A_c =$	1361 in <sup>2</sup>
Overall Depth of the Composite Section	$h_c =$	80 in
Moment of Inertia	$I_c =$	1,066,765 in <sup>4</sup>
Distance from centroid to extreme <u>bottom</u> fiber of beam	$y_{bc} =$	53.86 in
Distance from centroid to extreme <u>top</u> fiber of beam	$y_{tg} =$	18.14 in
Distance from centroid to extreme <u>top</u> fiber of slab	$y_{tc} =$	26.14 in
Section modulus for the extreme <u>bottom</u> fiber of beam	$S_{bc} =$	19,805.8 in <sup>3</sup>
Section modulus for the extreme <u>top</u> fiber of beam	$S_{tg} =$	58,811.6 in <sup>3</sup>
Section modulus for the extreme <u>top</u> fiber slab	$S_{tc} =$	58,645.5 in <sup>3</sup>

### DECK (as 12" beam)

Reinforcing per 12"		at midspan	at beams
Layer 1 (Bottom)	$A_s =$	0.3 in <sup>2</sup>	0.3 in <sup>2</sup>
Layer 2 (Top)	$A_s =$	0.2 in <sup>2</sup>	0.2 in <sup>2</sup>

Modulus of Elasticity = $33000 \cdot (W_c^{1.5}) \cdot (\sqrt{f'_c})$			
cast-in-place concrete deck	$E_{cs} =$	3530 ksi	
Moment of Inertia	$I_g =$	200 in <sup>4</sup>	
Distance from centroid to extreme <u>bottom</u> fiber of deck	$y_b =$	2.86 in	
Distance from centroid to extreme <u>top</u> fiber of deck	$y_t =$	5.14 in	
Modulus of Rupture	$f_r =$	436.7 psi	
Cracking Moment	$M_{CR} =$	2.5 ft-kips	1.4 ft-kips
Max negative moment at loading stage	$M_a =$	16.9 ft-kips	21.1 ft-kips
Cracking Moment of Inertia	$I_{cr} =$	87 in <sup>4</sup>	87 in <sup>4</sup>
Effective Moment of Inertia	$I_e =$	88 in <sup>4</sup>	87 in <sup>4</sup>
Effective Moment of Inertia for Continuous Beam	$I_e =$	87 in <sup>4</sup>	

### Shear Forces and Bending Moments

#### DEAD LOADS

Beam self-weight	$W_{beam} =$	0.799 k/f
8 in. deck weight	$W_{deck} =$	1.200 k/f
1/2 in. haunch weight	$W_{haunch} =$	0.022 k/f

LRFD Specifications: Art. 4.6.2.2.1

Width of Deck Constant		OK
Number of beams is not less than four $N_b =$	4	OK
Roadway part of the overhang, $d_o \leq 3.0$ ft, $d_o =$	1.5	OK
Curvature in plans is less than 4° =	0	OK
Cross-section of the bridge is consistent with one of the cross sections given by LRFD specs		OK

Barrier and wearing surface loads are equally distributed among the 4 beams

Barrier Wt	$W_t =$	0.150 k/f
Dead load of future wearing surface	$DW =$	0.263 k/f

LIVE LOADS		
Fire truck live load front load (Point A)	$P_{live} =$	48.0 kips
Fire truck live load back load (Point B)	$P_{live} =$	22.0 kips
distance between two loads		19.2 ft
distance from nearest edge to point A	$x_a =$	59.0 ft
distance from nearest edge to point B	$x_b =$	39.8 ft
LRFD Specifications: Art. 4.6.2.2.1		
Width of Deck Constant		OK
Number of beams is not less than four $N_b =$	4	OK
Beams are parallel and approximately of the same stiffness		OK
Roadway part of the overhang, $d_o \leq 3.0$ ft, $d_o =$	1.5	OK
Curvature in plans is less than $4^\circ =$	0	OK

Barrier and wearing surface loads are equally distributed among the 4 beams

Bridge Type-- "k" (LRFD Table 4.6.2.2.1-1)

Number of design lanes = $w/12$	=	3 lanes
---------------------------------	---	---------

**Distribution Factor for Bending Moment:**

Beams spacing	$S =$	12.0 ft
Depth of concrete slab	$t_s =$	7.5 in
Beam Span	$L =$	120.0 ft
Number of Beams	$N_b =$	4
Modular ratio between beam & deck materials	$n =$	1.4370
Longitudinal stiffness parameter	$K_y =$	2,508,620.17 in <sup>4</sup>

at center span:

$$DFM = 0.75 + \left(\frac{S}{9.5}\right)^{0.6} * \left(\frac{S}{L}\right)^{0.2} * \left(\frac{K_y}{12 * L * t_s^3}\right)^{0.1}$$

DFM =	0.911 lanes/beam
-------	------------------

0.905 Controls

one design lane loaded:

$$DFM = 0.75 + \left(\frac{S}{14}\right)^{0.6} * \left(\frac{S}{L}\right)^{0.3} * \left(\frac{K_y}{12 * L * t_s^3}\right)^{0.1}$$

DFM =	0.618 lanes/beam
-------	------------------

**Distribution Factor for Shear Force**

both end spans and center span:

$$DFV = 0.2 + \left(\frac{S}{12}\right) - \left(\frac{S}{35}\right)^2$$

DFV =	1.082 lanes/beam
-------	------------------

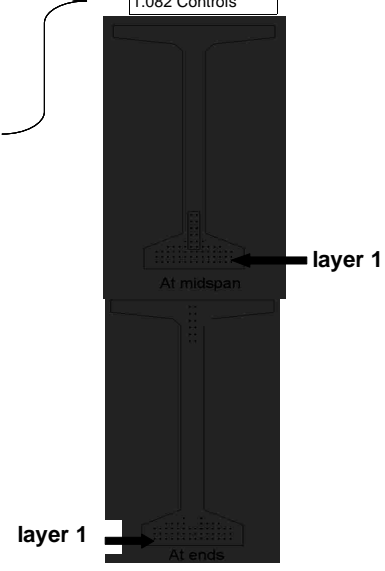
1.082 Controls

one design lane loaded:

$$DFV = 0.36 + \left(\frac{S}{25}\right)$$

DFV =	0.840 lanes/beam
-------	------------------

from bottom	At Midspan		At Ends	
	No. of	Distance from Bottom	No. of	Distance from Bottom
layer 1	14	2	14	2
layer 2	14	3.5	14	3.5
layer 3	14	5	14	5
layer 4	10	6.5	8	6.5
layer 5	4	8	2	8
layer 6	2	10	-	-
layer 7	2	12	-	-
layer 8	2	14	-	-
layer 9	2	16	2	60
layer 10	-	-	2	62
layer 11	-	-	2	64
layer 12	-	-	2	66
layer 13	-	-	2	68
layer 14	-	-	2	70
	64		64	
<b>Harped Strand Group (included in above totals)</b>				
layer 3	2	6		
layer 4	2	8		
layer 5	2	10		
layer 6	2	12		
layer 7	2	14		
layer 8	2	16		



distance from the center of gravity of strands to the bottom fiber of the beam = 7% of the beam depth  
strand eccentricity at midspan =  $(y_b - y_{bs})$

$y_{bs} =$	5.44 in
$e_c =$	31.16 in

### Prestress Losses

#### ELASTIC SHORTENING

assumed loss	=	6.00%
--------------	---	-------

Force per strand at transfer

layer 1	=	17.0 kips
layer 2	=	17.0 kips
layer 3	=	17.0 kips
layer 4	=	17.0 kips
layer 5	=	17.0 kips
layer 6	=	17.0 kips
layer 7	=	17.0 kips
layer 8	=	17.0 kips
layer 9	=	17.0 kips
layer 10	=	17.0 kips
layer 11	=	17.0 kips
layer 12	=	17.0 kips
layer 13	=	17.0 kips
layer 14	=	17.0 kips

Total prestressing force at release	$P_i =$	1088.0 kips	at midspan	1054.0 kips	at endspan
-------------------------------------	---------	-------------	------------	-------------	------------

Sum of concrete stresses at the center of gravity of prestressing tendons due to prestressing force at transfer and the self-weight of the member at sections of maximum moment

$f_{cgp} =$	2.412 ksi	2.307 ksi
-------------	-----------	-----------

Loss due to shortening

		at midspan	at endspan
layer 1	$\Delta f_{pES} =$	13.9 ksi	13.3 ksi
layer 2	$\Delta f_{pES} =$	13.9 ksi	13.3 ksi
layer 3	$\Delta f_{pES} =$	13.9 ksi	13.3 ksi
layer 4	$\Delta f_{pES} =$	13.9 ksi	13.3 ksi
layer 5	$\Delta f_{pES} =$	13.9 ksi	13.3 ksi
layer 6	$\Delta f_{pES} =$	13.9 ksi	
layer 7	$\Delta f_{pES} =$	13.9 ksi	
layer 8	$\Delta f_{pES} =$	13.9 ksi	
layer 9	$\Delta f_{pES} =$	13.9 ksi	13.3 ksi
layer 10	$\Delta f_{pES} =$		13.3 ksi
layer 11	$\Delta f_{pES} =$		13.3 ksi
layer 12	$\Delta f_{pES} =$		13.3 ksi
layer 13	$\Delta f_{pES} =$		13.3 ksi
layer 14	$\Delta f_{pES} =$		13.3 ksi

#### SHRINKAGE

Shrinkage =  $(17 - 0.15 \times \text{Relative Humidity})$

$\Delta f_{pSR} =$	6.5 ksi
--------------------	---------

← assume relative humidity = 70%

#### CREEP OF CONCRETE

Change of stresses at center of gravity of prestressing due to permanent loads except the loads acting at time of applying prestressing force, calculated at the same section as  $f_{cgp}$

$\Delta f_{cdp} =$	1.583 ksi	
--------------------	-----------	--

loss due to creep	$\Delta f_{PCR} =$	17.9 ksi	16.6 ksi
-------------------	--------------------	----------	----------

**RELAXATION OF PRESTRESSING STRANDS**

loss due to relaxation after transfer		at midspan	at endspan
layer 1	$\Delta f_{pR2} =$	2.9 ksi	2.9 ksi
layer 2	$\Delta f_{pR2} =$	2.9 ksi	2.9 ksi
layer 3	$\Delta f_{pR2} =$	2.9 ksi	2.9 ksi
layer 4	$\Delta f_{pR2} =$	2.9 ksi	2.9 ksi
layer 5	$\Delta f_{pR2} =$	2.9 ksi	2.9 ksi
layer 6	$\Delta f_{pR2} =$	2.9 ksi	
layer 7	$\Delta f_{pR2} =$	2.9 ksi	
layer 8	$\Delta f_{pR2} =$	2.9 ksi	
layer 9	$\Delta f_{pR2} =$	2.9 ksi	2.9 ksi
layer 10	$\Delta f_{pR2} =$		2.9 ksi
layer 11	$\Delta f_{pR2} =$		2.9 ksi
layer 12	$\Delta f_{pR2} =$		2.9 ksi
layer 13	$\Delta f_{pR2} =$		2.9 ksi
layer 14	$\Delta f_{pR2} =$		2.9 ksi

**TOTAL LOSSES AT TRANSFER**

total loss $\Delta f_{pES} = \Delta f_{pi}$		at midspan	at endspan
stress in tendons after transfer $f_{pt} = f_{pi} - \Delta f_{pi}$			
layer 1	$f_{pt} =$	199.3 ksi	199.9 ksi
layer 2	$f_{pt} =$	199.3 ksi	199.9 ksi
layer 3	$f_{pt} =$	199.3 ksi	199.9 ksi
layer 4	$f_{pt} =$	199.3 ksi	199.9 ksi
layer 5	$f_{pt} =$	199.3 ksi	199.9 ksi
layer 6	$f_{pt} =$	199.3 ksi	
layer 7	$f_{pt} =$	199.3 ksi	
layer 8	$f_{pt} =$	199.3 ksi	
layer 9	$f_{pt} =$	199.3 ksi	199.9 ksi
layer 10	$f_{pt} =$		199.9 ksi
layer 11	$f_{pt} =$		199.9 ksi
layer 12	$f_{pt} =$		199.9 ksi
layer 13	$f_{pt} =$		199.9 ksi
layer 14	$f_{pt} =$		199.9 ksi
force per strand = $f_{pi} \times$ strand area		at midspan	at endspan
layer 1	=	16.9 kips	17.0 kips
layer 2	=	16.9 kips	17.0 kips
layer 3	=	16.9 kips	17.0 kips
layer 4	=	16.9 kips	17.0 kips
layer 5	=	16.9 kips	17.0 kips
layer 6	=	16.9 kips	
layer 7	=	16.9 kips	
layer 8	=	16.9 kips	
layer 9	=	16.9 kips	17.0 kips
layer 10	=		17.0 kips
layer 11	=		17.0 kips
layer 12	=		17.0 kips
layer 13	=		17.0 kips
layer 14	=		17.0 kips
Total prestressing force after transfer	$P_i =$	1047.8 kips	1054.0 kips
Initial loss = $(\Delta f_{pi}) / (f_{pi})$		at midspan	at endspan
layer 1	% =	6.5%	6.2%
layer 2	% =	6.5%	6.2%
layer 3	% =	6.5%	6.2%
layer 4	% =	6.5%	6.2%
layer 5	% =	6.5%	6.2%
layer 6	% =	6.5%	
layer 7	% =	6.5%	
layer 8	% =	6.5%	
layer 9	% =	6.5%	6.2%
layer 10	% =		6.2%
layer 11	% =		6.2%
layer 12	% =		6.2%
layer 13	% =		6.2%
layer 14	% =		6.2%

OK  
OK  
OK  
OK  
OK  
OK  
OK  
OK  
OK  
OK  
OK  
OK  
OK  
OK  
OK

**TOTAL LOSSES AT SERVICE LOADS**

Total Losses		at midspan	at endspan
layer 1	$\Delta f_{pT} =$	41.1 ksi	40.5 ksi
layer 2	$\Delta f_{pT} =$	41.1 ksi	40.5 ksi
layer 3	$\Delta f_{pT} =$	41.1 ksi	40.5 ksi
layer 4	$\Delta f_{pT} =$	41.1 ksi	40.5 ksi
layer 5	$\Delta f_{pT} =$	41.1 ksi	40.5 ksi
layer 6	$\Delta f_{pT} =$	41.1 ksi	
layer 7	$\Delta f_{pT} =$	41.1 ksi	
layer 8	$\Delta f_{pT} =$	41.1 ksi	
layer 9	$\Delta f_{pT} =$	41.1 ksi	40.5 ksi
layer 10	$\Delta f_{pT} =$		40.5 ksi
layer 11	$\Delta f_{pT} =$		40.5 ksi
layer 12	$\Delta f_{pT} =$		40.5 ksi
layer 13	$\Delta f_{pT} =$		40.5 ksi
layer 14	$\Delta f_{pT} =$		40.5 ksi

Stress in tendon after all losses =  $f_{pi} - \Delta f_{pt}$

		at midspan	at endspan
layer 1	$f_{pe} =$	172.0 ksi	172.6 ksi
layer 2	$f_{pe} =$	172.0 ksi	172.6 ksi
layer 3	$f_{pe} =$	172.0 ksi	172.6 ksi
layer 4	$f_{pe} =$	172.0 ksi	172.6 ksi
layer 5	$f_{pe} =$	172.0 ksi	172.6 ksi
layer 6	$f_{pe} =$	172.0 ksi	
layer 7	$f_{pe} =$	172.0 ksi	
layer 8	$f_{pe} =$	172.0 ksi	
layer 9	$f_{pe} =$	172.0 ksi	172.6 ksi
layer 10	$f_{pe} =$		172.6 ksi
layer 11	$f_{pe} =$		172.6 ksi
layer 12	$f_{pe} =$		172.6 ksi
layer 13	$f_{pe} =$		172.6 ksi
layer 14	$f_{pe} =$		172.6 ksi

check prestressing stress limit at service limit state:  $f_{pe} \leq 0.8 * f_{py}$

layer 1	=	205.4 ksi
layer 2	=	205.4 ksi
layer 3	=	205.4 ksi
layer 4	=	205.4 ksi
layer 5	=	205.4 ksi
layer 6	=	205.4 ksi
layer 7	=	205.4 ksi
layer 8	=	205.4 ksi
layer 9	=	205.4 ksi
layer 10	=	205.4 ksi
layer 11	=	205.4 ksi
layer 12	=	205.4 ksi
layer 13	=	205.4 ksi
layer 14	=	205.4 ksi

OK  
OK  
OK  
OK  
OK  
OK  
OK  
OK  
OK  
OK  
OK  
OK  
OK  
OK

force per strand =  $f_{pe} * \text{strand area}$

		at midspan	at endspan
layer 1	=	14.6 kips	14.7 kips
layer 2	=	14.6 kips	14.7 kips
layer 3	=	14.6 kips	14.7 kips
layer 4	=	14.6 kips	14.7 kips
layer 5	=	14.6 kips	14.7 kips
layer 6	=	14.6 kips	
layer 7	=	14.6 kips	
layer 8	=	14.6 kips	
layer 9	=	14.6 kips	14.7 kips
layer 10	=		14.7 kips
layer 11	=		14.7 kips
layer 12	=		14.7 kips
layer 13	=		14.7 kips
layer 14	=		14.7 kips

		at midspan	at endspan
Total prestressing force after all losses	$P_{pe} =$	935.8 kips	939.1 kips
Final losses, % = $(\Delta f_{pT})/(f_{pi})$			
layer 1	% =	19.3%	19.0%
layer 2	% =	19.3%	19.0%
layer 3	% =	19.3%	19.0%
layer 4	% =	19.3%	19.0%
layer 5	% =	19.3%	19.0%
layer 6	% =	19.3%	
layer 7	% =	19.3%	
layer 8	% =	19.3%	
layer 9	% =	19.3%	19.0%
layer 10	% =		19.0%
layer 11	% =		19.0%
layer 12	% =		19.0%
layer 13	% =		19.0%
layer 14	% =		19.0%
Average final losses, %	% =	19.3%	19.0%

### Stresses at Transfer

#### STRESS LIMITS FOR CONCRETE

Compression = $0.6f_{ci}$	$f_{ci} =$	3.300 ksi
Tension		
without bonded reinforcement = $-0.0948\sqrt{f_{ci}} \leq -0.2$	=	-0.200 ksi
with bonded auxiliary reinforcement = $-0.22\sqrt{f_{ci}}$	=	-0.016 ksi

#### STRESSES AT TRANSFER LENGTH SECTION

Transfer Length = $60 \times$ (strand diameter)	=	1.9 ft	} Calcs for eccentricity (see 9.6.7.2)
Bending moment at transfer length	$M_g =$	87.7 ft-kips	
center of 12 strands to top fiber of beam at the end	=	7.00 in	
center of 12 strands to bottom fiber of beam at the harp point	=	11.00 in	
center of gravity of 12 strands and top fiber of beam at transfer length	=	9.84 in	
center of gravity of 32 strands and bottom fiber of beam	=	3.98 in	
center of gravity of all strands and the bottom fiber of beam at transfer length	=	15.24 in	
center of gravity of all strands and the bottom fiber of beam at the end	=	15.30 in	
Eccentricity of the strand group at transfer length:	$e_n =$	21.36 in	}
Eccentricity at end of beam:	$e =$	21.30 in	

$$f_t = \frac{P_i}{A} - \frac{P_i e}{S_t} + \frac{M_g}{S_t}$$

$$f_b = \frac{P_i}{A} + \frac{P_i e}{S_b} - \frac{M_g}{S_b}$$

		at midspan	at endspan	
Top stress at top fiber of beam	$f_t =$	-0.017 ksi	-0.017 ksi	OK
Bottom stress at bottom fiber of the beam	$f_b =$	2.906 ksi	2.906 ksi	OK

#### STRESSES AT HARP POINT

Bending moment due to beam weight at 0.3L	$M_g =$	1188.0 ft-kips		
Top stress at top fiber of beam	$f_t =$	0.173 ksi	0.169 ksi	OK
Bottom stress at bottom fiber of the beam	$f_b =$	2.736 ksi	2.621 ksi	OK

#### STRESSES AT MIDSPAN

Bending moment due to beam weight at 0.5L	$M_g =$	1414.3 ft-kips		
Top stress at top fiber of beam	$f_t =$	0.320 ksi	0.345 ksi	OK
Bottom stress at bottom fiber of the beam	$f_b =$	2.554 ksi	2.438 ksi	OK

### HOLD-DOWN FORCES

assume stress in strand before losses =  $0.8f_u$

layer 1	=	227.4 ksi
layer 2	=	227.4 ksi
layer 3	=	227.4 ksi
layer 4	=	227.4 ksi
layer 5	=	227.4 ksi
layer 6	=	227.4 ksi
layer 7	=	227.4 ksi
layer 8	=	227.4 ksi
layer 9	=	227.4 ksi
layer 10	=	227.4 ksi
layer 11	=	227.4 ksi
layer 12	=	227.4 ksi
layer 13	=	227.4 ksi
layer 14	=	227.4 ksi

prestress force per strand before any losses:

layer 1	=	19.3 kips
layer 2	=	19.3 kips
layer 3	=	19.3 kips
layer 4	=	19.3 kips
layer 5	=	19.3 kips
layer 6	=	19.3 kips
layer 7	=	19.3 kips
layer 8	=	19.3 kips
layer 9	=	19.3 kips
layer 10	=	19.3 kips
layer 11	=	19.3 kips
layer 12	=	19.3 kips
layer 13	=	19.3 kips
layer 14	=	19.3 kips
Harp Angle	$\psi$ =	7.2 °

Hold-down force/strand

layer 1	=	2.5 kips/strand
layer 2	=	2.5 kips/strand
layer 3	=	2.5 kips/strand
layer 4	=	2.5 kips/strand
layer 5	=	2.5 kips/strand
layer 6	=	2.5 kips/strand
layer 7	=	2.5 kips/strand
layer 8	=	2.5 kips/strand
layer 9	=	2.5 kips/strand
layer 10	=	2.5 kips/strand
layer 11	=	2.5 kips/strand
layer 12	=	2.5 kips/strand
layer 13	=	2.5 kips/strand
layer 14	=	2.5 kips/strand
Total hold-down force	=	30.45 kips

### Stresses at Service Loads

#### STRESS LIMITS FOR CONCRETE

##### Compression:

Due to permanent loads for load combination Service I

for the precast beam	=	3.150 ksi
for deck	=	1.526 ksi

Due to permanent and transient loads for load combination Service I

for the precast beam	=	4.200 ksi
for deck	=	2.034 ksi

##### Tension:

Load Combination Service III

for the precast beam	=	-0.016 ksi
----------------------	---	------------

STRESSES AT MIDSPAN			
Compression stresses at top fiber of beam		at midspan	at endspan
$f_s = \frac{F_{ps}}{A} - \frac{F_{ps}e}{S_t} + \frac{(M_D + M_L)}{S_t} + \frac{(M_{L2} + M_D)}{S_{L2}}$			
Due to permanent loads	$f_{ig} =$	2.107 ksi	2.105 ksi
$f_{L2} = \frac{F_{ps}}{A} - \frac{F_{ps}e}{S_t} + \frac{(M_D + M_L)}{S_t} + \frac{(M_{L2} + M_D)}{S_{L2}} + \frac{(M_{L+1})}{S_{L+1}}$			
Due to permanent loads and transient loads	$f_{ig} =$	2.539 ksi	2.536 ksi
Compression stresses at top fiber of deck		at midspan	at endspan
$f_{fr} = \frac{(M_{L2} + M_D)}{S_{fr}}$			
Due to permanent loads	$f_{ic} =$	0.041 ksi	0.041 ksi
$f_{fr} = \frac{(M_{L2} + M_D + M_{L+1})}{S_{fr}}$			
Due to permanent loads and transient loads	$f_{ic} =$	0.474 ksi	0.474 ksi
Tension stresses at top fiber of deck		at midspan	at endspan
$f_{tr} = \frac{P_{pe}}{A} + \frac{F_{pe}e}{S_b} - \frac{(M_D + M_L)}{S_b} - \frac{(M_{L2} + M_D + 0.8 \cdot M_{L+1})}{S_{L2}}$			
Load Combination Service III	$f_b =$	-0.802 ksi	-0.791 ksi

OK

OK

OK

OK

OK

**Strength Limit State**

POSITIVE MOMENT SECTION			
$M_u = 1.25DC + 1.5DW + 1.75(LL + IM)$	$M_u =$	8381.5 ft-kips	
effective length factor for compression members			
layer 1	k =	0.27	
layer 2	k =	0.27	
layer 3	k =	0.27	
layer 4	k =	0.27	
layer 5	k =	0.27	
layer 6	k =	0.27	
layer 7	k =	0.27	
layer 8	k =	0.27	
layer 9	k =	0.27	
layer 10	k =	0.27	
layer 11	k =	0.27	
layer 12	k =	0.27	
layer 13	k =	0.27	
layer 14	k =	0.27	
	c =	5.4 ft-kips	
average stress in prestressing steel			
layer 1	$f_{ps} =$	278.6 ksi	
layer 2	$f_{ps} =$	278.6 ksi	
layer 3	$f_{ps} =$	278.6 ksi	
layer 4	$f_{ps} =$	278.6 ksi	
layer 5	$f_{ps} =$	278.6 ksi	
layer 6	$f_{ps} =$	278.6 ksi	
layer 7	$f_{ps} =$	278.6 ksi	
layer 8	$f_{ps} =$	278.6 ksi	
layer 9	$f_{ps} =$	278.6 ksi	
layer 10	$f_{ps} =$	278.6 ksi	
layer 11	$f_{ps} =$	278.6 ksi	
layer 12	$f_{ps} =$	278.6 ksi	
layer 13	$f_{ps} =$	278.6 ksi	
layer 14	$f_{ps} =$	278.6 ksi	
nominal flexure resistance			
	a =	4.61 in	
$M_r = \Phi M_n, \Phi = 1.00$	$\Phi M_n =$	9125.1 ft-kips	OK
NEGATIVE MOMENT SECTION			
$M_u = 1.25DC + 1.5DW + 1.75(LL + IM)$	$M_u =$	-4837.2 ft-kips	
	a =	0.19 in	
	$\Phi M_n =$	4945.9 ft-kips	OK



### Shear Design

CRITICAL SECTION AT 0.59		
$V_u = 1.25DC + 1.5DW + 1.75(LL + IM)$	$V_u =$	405.0 kips
$M_u = 1.25DC + 1.5DW + 1.75(LL + IM)$	$M_u =$	-2684.4 ft-kips
or		
$V_u = 1.25DC + 1.5DW + 1.75(LL + IM)$	$V_u =$	364.8 kips
$M_u = 1.25DC + 1.5DW + 1.75(LL + IM)$	$M_u =$	-2877.0 ft-kips
max shear	$V_u =$	405.0 kips
max moment	$M_u =$	2877.0 ft-kips
Shear depth	$d_v =$	73.19 in
Applied factored normal force at the section	$N_u =$	0
Angle of diagonal compressive stresses	$\theta =$	36.00 °

### STRAIN IN FLEXURAL TENSION REINFORCEMENT

$$\epsilon_s = \frac{\frac{M_u}{d_v} + 0.5M_u + 0.5N_u \cot \theta - A_{ps}f_{ps}}{E_s A_s + E_p A_{ps}} \leq 0.002$$

	at midspan	at endspan	
resultant compressive stress at centroid	$f_{pc} =$	0.923 ksi	0.925 ksi
effective stress in prestressing strand after all losses			
layer 1	$f_{po} =$	176.7 ksi	177.3 ksi
layer 2	$f_{po} =$	176.7 ksi	177.3 ksi
layer 3	$f_{po} =$	176.7 ksi	177.3 ksi
layer 4	$f_{po} =$	176.7 ksi	177.3 ksi
layer 5	$f_{po} =$	176.7 ksi	
layer 6	$f_{po} =$	176.7 ksi	
layer 7	$f_{po} =$	176.7 ksi	
layer 8	$f_{po} =$	176.7 ksi	
layer 9	$f_{po} =$		177.3 ksi
layer 10	$f_{po} =$		177.3 ksi
layer 11	$f_{po} =$		177.3 ksi
layer 12	$f_{po} =$		177.3 ksi
layer 13	$f_{po} =$		177.3 ksi
layer 14	$f_{po} =$		177.3 ksi
strain in flexural tension		at midspan	at endspan
layer 1	$\epsilon_x =$	0.002000	0.002000
layer 2	$\epsilon_x =$	0.002000	0.002000
layer 3	$\epsilon_x =$	0.002000	0.002000
layer 4	$\epsilon_x =$	0.002000	0.002000
layer 5	$\epsilon_x =$	0.002000	
layer 6	$\epsilon_x =$	0.002000	
layer 7	$\epsilon_x =$	0.002000	
layer 8	$\epsilon_x =$	0.002000	
layer 9	$\epsilon_x =$		0.002000
layer 10	$\epsilon_x =$		0.002000
layer 11	$\epsilon_x =$		0.002000
layer 12	$\epsilon_x =$		0.002000
layer 13	$\epsilon_x =$		0.002000
layer 14	$\epsilon_x =$		0.002000

### Deflection and Camber

	at midspan	at endspan	
Deflection due to Prestressing Force at Transfer	$\Delta_p =$	3.27 in	0.62 in
Deflection due to Beam Self-Weight at Transfer	$\Delta_g =$	-1.49 in	
Deflection due to Beam Self-Weight at Erection	$\Delta_{g1} =$	-1.44 in	
Deflection due to Haunch and Deck	$\Delta_g =$	-1.95 in	

Deflection due to total self weight	$\Delta_{sw} =$	-0.11 in
-------------------------------------	-----------------	----------

Total Deflection at transfer	$\Delta =$	1.79 in	-0.86 in
Total Deflection at erection	$\Delta =$	3.24 in	-1.53 in

### Deck Deflection (assuming 12" beam)

Deflection due to Deck Self-Weight	$\Delta_g =$	-1.1719 in
Live load deflection limit = span/800	$=$	0.18 in
Deflection due to live load and impact	$\Delta_L =$	-0.34 in

OK

**Location: Fire above Deck Between Girders**  
**Beam Design: 3/8" Strand**  
**Fire Exposure Status: 2 Hour**

(PCI Bridge Design Manual Section 9.6)

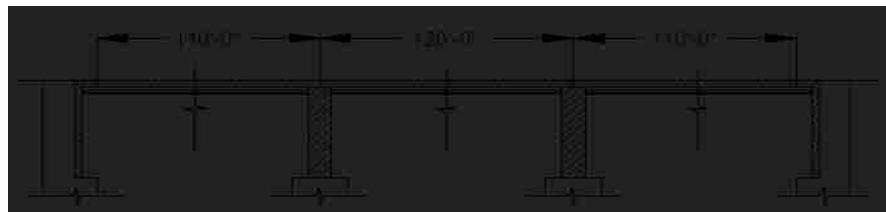


**Material Properties**

CAST-IN-PLACE SLAB			
Actual Thickness	$t_{as} =$		8.0 in
Wearing Surface	$=$		0.5 in
Structural thickness = Actual - Wearing Surface	$t_s =$		7.5 in
Compressive Strength	$f_c =$		3.25 ksi
Unit Weight	$w_c =$		150.0 pcf
Stress factor of compression block	$\beta_1 =$		0.85

BEAMS: AASHTO-PCI, BT-72 BULB-TEE			
Strength at release	$f_{ci} =$		5.5 ksi
Strength at 28 days	$f_c =$		7 ksi
Unit Weight	$w_c =$		150.0 pcf
Overall Beam Length:			
@ end spans	$L =$		110 ft
@ center span	$L =$		119 ft
Design Spans:			
Non-composite beam @ end spans	$L =$		109 ft
Non-composite beam @ center span	$L =$		118 ft
Composite beam @ end spans	$L =$		110 ft
Composite beam @ center span	$L =$		120 ft
Beam Spacing	$S =$		12 ft



**PRESTRESSING STRANDS**

Diameter of single strand	d =	0.4 in
Area of single strand	A =	0.085 in <sup>2</sup>
Temperature of Layer		
	layer 1 (bottom)	T = 68.00 °F
	layer 2	T = 68.00 °F
	layer 3	T = 68.00 °F
	layer 4	T = 68.00 °F
	layer 5	T = 68.00 °F
	layer 6	T = 68.00 °F
	layer 7	T = 68.00 °F
	layer 8	T = 68.00 °F
	layer 9	T = 68.00 °F
	layer 10	T = 68.00 °F
	layer 11	T = 68.00 °F
	layer 12	T = 68.00 °F
	layer 13	T = 68.00 °F
	layer 14	T = 68.00 °F
Ultimate Strength		
initial = 284 ksi	layer 1 (bottom)	f <sub>pu</sub> = 284 ksi
	layer 2	f <sub>pu</sub> = 284 ksi
	layer 3	f <sub>pu</sub> = 284 ksi
	layer 4	f <sub>pu</sub> = 284 ksi
	layer 5	f <sub>pu</sub> = 284 ksi
	layer 6	f <sub>pu</sub> = 284 ksi
	layer 7	f <sub>pu</sub> = 284 ksi
	layer 8	f <sub>pu</sub> = 284 ksi
	layer 9	f <sub>pu</sub> = 284 ksi
	layer 10	f <sub>pu</sub> = 284 ksi
	layer 11	f <sub>pu</sub> = 284 ksi
	layer 12	f <sub>pu</sub> = 284 ksi
	layer 13	f <sub>pu</sub> = 284 ksi
	layer 14	f <sub>pu</sub> = 284 ksi
Yield Strength		
initial = 257 ksi	layer 1 (bottom)	f <sub>py</sub> = 257 ksi
	layer 2	f <sub>py</sub> = 257 ksi
	layer 3	f <sub>py</sub> = 257 ksi
	layer 4	f <sub>py</sub> = 257 ksi
	layer 5	f <sub>py</sub> = 257 ksi
	layer 6	f <sub>py</sub> = 257 ksi
	layer 7	f <sub>py</sub> = 257 ksi
	layer 8	f <sub>py</sub> = 257 ksi
	layer 9	f <sub>py</sub> = 257 ksi
	layer 10	f <sub>py</sub> = 257 ksi
	layer 11	f <sub>py</sub> = 257 ksi
	layer 12	f <sub>py</sub> = 257 ksi
	layer 13	f <sub>py</sub> = 257 ksi
	layer 14	f <sub>py</sub> = 257 ksi
<b>Stress Limits:</b>		
before transfer ≤ 0.75f <sub>pu</sub> (initial = 213.2)	layer 1 (bottom)	f <sub>pi</sub> = 213.2 ksi
	layer 2	f <sub>pi</sub> = 213.2 ksi
	layer 3	f <sub>pi</sub> = 213.2 ksi
	layer 4	f <sub>pi</sub> = 213.2 ksi
	layer 5	f <sub>pi</sub> = 213.2 ksi
	layer 6	f <sub>pi</sub> = 213.2 ksi
	layer 7	f <sub>pi</sub> = 213.2 ksi
	layer 8	f <sub>pi</sub> = 213.2 ksi
	layer 9	f <sub>pi</sub> = 213.2 ksi
	layer 10	f <sub>pi</sub> = 213.2 ksi
	layer 11	f <sub>pi</sub> = 213.2 ksi
	layer 12	f <sub>pi</sub> = 213.2 ksi
	layer 13	f <sub>pi</sub> = 213.2 ksi
	layer 14	f <sub>pi</sub> = 213.2 ksi

at service limit state (after all losses)  $\leq 0.80f_{py}$  (initial = 205.4)

layer 1 (bottom)	$f_{pe} =$	205.4 ksi
layer 2	$f_{pe} =$	205.4 ksi
layer 3	$f_{pe} =$	205.4 ksi
layer 4	$f_{pe} =$	205.4 ksi
layer 5	$f_{pe} =$	205.4 ksi
layer 6	$f_{pe} =$	205.4 ksi
layer 7	$f_{pe} =$	205.4 ksi
layer 8	$f_{pe} =$	205.4 ksi
layer 9	$f_{pe} =$	205.4 ksi
layer 10	$f_{pe} =$	205.4 ksi
layer 11	$f_{pe} =$	205.4 ksi
layer 12	$f_{pe} =$	205.4 ksi
layer 13	$f_{pe} =$	205.4 ksi
layer 14	$f_{pe} =$	205.4 ksi

Modulus of Elasticity

initial = 25898 ksi

layer 1 (bottom)	E =	25898.0 ksi
layer 2	E =	25898.0 ksi
layer 3	E =	25898.0 ksi
layer 4	E =	25898.0 ksi
layer 5	E =	25898.0 ksi
layer 6	E =	25898.0 ksi
layer 7	E =	25898.0 ksi
layer 8	E =	25898.0 ksi
layer 9	E =	25898.0 ksi
layer 10	E =	25898.0 ksi
layer 11	E =	25898.0 ksi
layer 12	E =	25898.0 ksi
layer 13	E =	25898.0 ksi
layer 14	E =	25898.0 ksi

### MILD STEEL REINFORCING BARS AT ENDSPAN

Yield Strength

Layer 1 (Bottom)	$f_y =$	60.0 ksi	68.00 °F
Layer 2 (Top)	$f_y =$	53.3 ksi	1120.00 °F

Modulus of Elasticity

Layer 1 (Bottom)	E =	29000.0 ksi
Layer 2 (Top)	E =	29000.0 ksi

Layer 1 (Bottom)

Area of steel at midspan (effective flange)	$A_{sm} =$	2.79 in <sup>2</sup>
Area of steel at endspan (effective flange)	$A_{se} =$	2.48 in <sup>2</sup>
Area of temperature and shrinkage steel (12" width)	$A_s =$	0.31 in <sup>2</sup>

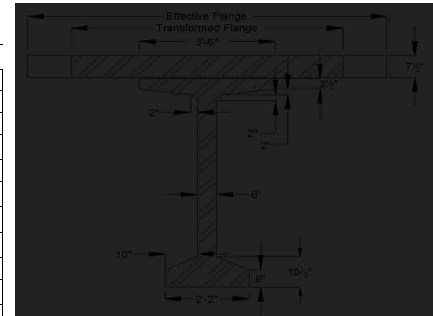
Layer 2 (Top)

Area of steel at midspan (effective flange)	$A_{sm} =$	12.6 in <sup>2</sup>
Area of steel at endspan (effective flange)	$A_{se} =$	12.4 in <sup>2</sup>
Area of temperature and shrinkage steel (12" width)	$A_s =$	0.2 in <sup>2</sup>

### Cross-sectional Properties

#### NON-COMPOSITE BEAM

Area of cross-section of beam	A =	767.0 in <sup>2</sup>
Overall depth of beam	H =	72.0 in
Moment of Inertia	I =	539,947 in <sup>4</sup>
Distance from centroid to extreme <b>bottom</b> fiber	$y_b =$	36.6 in
Distance from centroid to extreme <b>top</b> fiber	$y_t =$	35.4 in
Section modulus for the extreme <b>bottom</b> fiber	$S_b =$	14915.0 in <sup>3</sup>
Section modulus for the extreme <b>top</b> fiber	$S_t =$	15421.0 in <sup>3</sup>
Weight	$W_t =$	799.0 plf
Modulus of Elasticity = $33000 \cdot (W_c^{1.5}) \cdot (\sqrt{f'_c})$		
cast-in-place concrete deck	$E_{cs} =$	3456 ksi
precast beam at release	$E_{ci} =$	4496 ksi
precast beam at service loads	$E_c =$	5072 ksi



### COMPOSITE BEAM

Effective Flange Width	$b_f =$	111.0 in	*min of three criteria
Modular Ratio = $E_{cs}/E_c$	$n =$	0.6814	
Transformed flange width	$=$	75.6 in	
Transformed flange area	$=$	567.3 in <sup>2</sup>	
Transformed haunch width	$=$	28.6 in	
Transformed haunch area	$=$	14.3 in <sup>2</sup>	

	Transformed Area	y <sub>b</sub>	Ay <sub>b</sub>	A(y <sub>bc</sub> -y <sub>b</sub> ) <sup>2</sup>	I	I + A(y <sub>bc</sub> -y <sub>b</sub> ) <sup>2</sup>
Beam	767.0 in <sup>2</sup>	36.60 in	28,072.2 in <sup>3</sup>	223,138 in <sup>4</sup>	539,947 in <sup>4</sup>	763,085 in <sup>4</sup>
Haunch	14.3 in <sup>2</sup>	72.25 in	1,033.8 in <sup>3</sup>	4,947 in <sup>4</sup>	0.33 in <sup>4</sup>	4,947 in <sup>4</sup>
Deck	567.3 in <sup>2</sup>	76.25 in	43,253.1 in <sup>3</sup>	289,564 in <sup>4</sup>	2,950 in <sup>4</sup>	292,514 in <sup>4</sup>
Total	1348.6 in <sup>2</sup>		72,359.1 in <sup>3</sup>			1,060,546 in <sup>4</sup>

Total area of Composite Section	$A_c =$	1349 in <sup>2</sup>
Overall Depth of the Composite Section	$h_c =$	80 in
Moment of Inertia	$I_c =$	1,060,546 in <sup>4</sup>
Distance from centroid to extreme <u>bottom</u> fiber of beam	$y_{bc} =$	53.66 in
Distance from centroid to extreme <u>top</u> fiber of beam	$y_{tb} =$	18.34 in
Distance from centroid to extreme <u>top</u> fiber of slab	$y_{tc} =$	26.34 in
Section modulus for the extreme <u>bottom</u> fiber of beam	$S_{bc} =$	19,765.5 in <sup>3</sup>
Section modulus for the extreme <u>top</u> fiber of beam	$S_{tb} =$	57,815.8 in <sup>3</sup>
Section modulus for the extreme <u>top</u> fiber slab	$S_{tc} =$	59,083.0 in <sup>3</sup>

### DECK (as 12" beam)

Reinforcing per 12"		at midspan	at beams
Layer 1 (Bottom)	$A_s =$	0.3 in <sup>2</sup>	0.3 in <sup>2</sup>
Layer 2 (Top)	$A_s =$	0.2 in <sup>2</sup>	0.2 in <sup>2</sup>

Modulus of Elasticity = $33000 \cdot (W_c^{1.5}) \cdot (\sqrt{f'_c})$	$E_{cs} =$	3456 ksi	
cast-in-place concrete deck			
Moment of Inertia	$I_g =$	166 in <sup>4</sup>	
Distance from centroid to extreme <u>bottom</u> fiber of deck	$y_b =$	2.66 in	
Distance from centroid to extreme <u>top</u> fiber of deck	$y_t =$	5.34 in	
Modulus of Rupture	$f_r =$	427.6 psi	
Cracking Moment	$M_{CR} =$	2.2 ft-kips	1.1 ft-kips
Max negative moment at loading stage	$M_a =$	16.9 ft-kips	21.1 ft-kips
Cracking Moment of Inertia	$I_{cr} =$	87 in <sup>4</sup>	87 in <sup>4</sup>
Effective Moment of Inertia	$I_e =$	87 in <sup>4</sup>	87 in <sup>4</sup>
Effective Moment of Inertia for Continuous Beam	$I_e =$	87 in <sup>4</sup>	

### Shear Forces and Bending Moments

#### DEAD LOADS

Beam self-weight	$W_{beam} =$	0.799 k/f
8 in. deck weight	$W_{deck} =$	1.200 k/f
1/2 in. haunch weight	$W_{haunch} =$	0.022 k/f

LRFD Specifications: Art. 4.6.2.2.1		
Width of Deck Constant		OK
Number of beams is not less than four $N_b =$	4	OK
Roadway part of the overhang, $d_o \leq 3.0$ ft, $d_o =$	1.5	OK
Curvature in plans is less than 4° =	0	OK
Cross-section of the bridge is consistent with one of the cross sections given by LRFD specs		OK

Barrier and wearing surface loads are equally distributed among the 4 beams

Barrier Wt	$W_t =$	0.150 k/f
Dead load of future wearing surface	$DW =$	0.263 k/f

LIVE LOADS		
Fire truck live load front load (Point A)	$P_{live} =$	48.0 kips
Fire truck live load back load (Point B)	$P_{live} =$	22.0 kips
distance between two loads		19.2 ft
distance from nearest edge to point A	$x_a =$	59.0 ft
distance from nearest edge to point B	$x_b =$	39.8 ft
LRFD Specifications: Art. 4.6.2.2.1		
Width of Deck Constant		OK
Number of beams is not less than four $N_b =$	4	OK
Beams are parallel and approximately of the same stiffness		OK
Roadway part of the overhang, $d_o \leq 3.0$ ft, $d_o =$	1.5	OK
Curvature in plans is less than $4^\circ =$	0	OK

Barrier and wearing surface loads are equally distributed among the 4 beams

Bridge Type-- "k" (LRFD Table 4.6.2.2.1-1)

Number of design lanes = $w/12$	=	3 lanes
---------------------------------	---	---------

**Distribution Factor for Bending Moment:**

Beams spacing	$S =$	12.0 ft
Depth of concrete slab	$t_s =$	7.5 in
Beam Span	$L =$	120.0 ft
Number of Beams	$N_b =$	4
Modular ratio between beam & deck materials	$n =$	1.4676
Longitudinal stiffness parameter	$K_y =$	2,562,082.31 in <sup>4</sup>

at center span:

$$DFM = 0.75 + \left(\frac{S}{9.5}\right)^{0.6} * \left(\frac{S}{L}\right)^{0.2} * \left(\frac{K_y}{12 * L * t_s^3}\right)^{0.1}$$

DFM =	0.913 lanes/beam
-------	------------------

0.905 Controls

one design lane loaded:

$$DFM = 0.75 + \left(\frac{S}{14}\right)^{0.6} * \left(\frac{S}{L}\right)^{0.3} * \left(\frac{K_y}{12 * L * t_s^3}\right)^{0.1}$$

DFM =	0.619 lanes/beam
-------	------------------

**Distribution Factor for Shear Force**

both end spans and center span:

$$DFV = 0.2 + \left(\frac{S}{12}\right) - \left(\frac{S}{35}\right)^2$$

DFV =	1.082 lanes/beam
-------	------------------

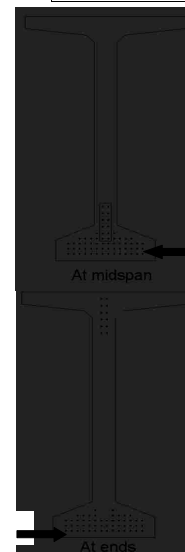
1.082 Controls

one design lane loaded:

$$DFV = 0.36 + \left(\frac{S}{25}\right)$$

DFV =	0.840 lanes/beam
-------	------------------

from bottom	At Midspan		At Ends	
	No. of	Distance from Bottom	No. of	Distance from Bottom
layer 1	14	2	14	2
layer 2	14	3.5	14	3.5
layer 3	14	5	14	5
layer 4	10	6.5	8	6.5
layer 5	4	8	2	8
layer 6	2	10	-	-
layer 7	2	12	-	-
layer 8	2	14	-	-
layer 9	2	16	2	60
layer 10	-	-	2	62
layer 11	-	-	2	64
layer 12	-	-	2	66
layer 13	-	-	2	68
layer 14	-	-	2	70
	64		64	
<b>Harped Strand Group (included in above totals)</b>				
layer 3	2	6		
layer 4	2	8		
layer 5	2	10		
layer 6	2	12		
layer 7	2	14		
layer 8	2	16		



layer 1

distance from the center of gravity of strands to the bottom fiber of the beam = 7% of the beam depth  
strand eccentricity at midspan =  $(y_b - y_{bs})$

$y_{bs} =$	5.44 in
$e_c =$	31.16 in

### Prestress Losses

#### ELASTIC SHORTENING

assumed loss	=	6.00%
--------------	---	-------

Force per strand at transfer

layer 1	=	17.0 kips
layer 2	=	17.0 kips
layer 3	=	17.0 kips
layer 4	=	17.0 kips
layer 5	=	17.0 kips
layer 6	=	17.0 kips
layer 7	=	17.0 kips
layer 8	=	17.0 kips
layer 9	=	17.0 kips
layer 10	=	17.0 kips
layer 11	=	17.0 kips
layer 12	=	17.0 kips
layer 13	=	17.0 kips
layer 14	=	17.0 kips

Total prestressing force at release	$P_i =$	1088.0 kips	at midspan	1054.0 kips	at endspan
-------------------------------------	---------	-------------	------------	-------------	------------

Sum of concrete stresses at the center of gravity of prestressing tendons due to prestressing force at transfer and the self-weight of the member at sections of maximum moment

$f_{cgp} =$	2.412 ksi	2.307 ksi
-------------	-----------	-----------

Loss due to shortening

		at midspan	at endspan
layer 1	$\Delta f_{pES} =$	13.9 ksi	13.3 ksi
layer 2	$\Delta f_{pES} =$	13.9 ksi	13.3 ksi
layer 3	$\Delta f_{pES} =$	13.9 ksi	13.3 ksi
layer 4	$\Delta f_{pES} =$	13.9 ksi	13.3 ksi
layer 5	$\Delta f_{pES} =$	13.9 ksi	13.3 ksi
layer 6	$\Delta f_{pES} =$	13.9 ksi	
layer 7	$\Delta f_{pES} =$	13.9 ksi	
layer 8	$\Delta f_{pES} =$	13.9 ksi	
layer 9	$\Delta f_{pES} =$	13.9 ksi	13.3 ksi
layer 10	$\Delta f_{pES} =$		13.3 ksi
layer 11	$\Delta f_{pES} =$		13.3 ksi
layer 12	$\Delta f_{pES} =$		13.3 ksi
layer 13	$\Delta f_{pES} =$		13.3 ksi
layer 14	$\Delta f_{pES} =$		13.3 ksi

#### SHRINKAGE

Shrinkage =  $(17 - 0.15 \times \text{Relative Humidity})$

$\Delta f_{pSR} =$	6.5 ksi
--------------------	---------

← assume relative humidity = 70%

#### CREEP OF CONCRETE

Change of stresses at center of gravity of prestressing due to permanent loads except the loads acting at time of applying prestressing force, calculated at the same section as  $f_{cgp}$

$\Delta f_{cdp} =$	1.583 ksi	
--------------------	-----------	--

loss due to creep	$\Delta f_{PCR} =$	17.9 ksi	16.6 ksi
-------------------	--------------------	----------	----------

**RELAXATION OF PRESTRESSING STRANDS**

loss due to relaxation after transfer		at midspan	at endspan
layer 1	$\Delta f_{pR2} =$	2.9 ksi	2.9 ksi
layer 2	$\Delta f_{pR2} =$	2.9 ksi	2.9 ksi
layer 3	$\Delta f_{pR2} =$	2.9 ksi	2.9 ksi
layer 4	$\Delta f_{pR2} =$	2.9 ksi	2.9 ksi
layer 5	$\Delta f_{pR2} =$	2.9 ksi	2.9 ksi
layer 6	$\Delta f_{pR2} =$	2.9 ksi	
layer 7	$\Delta f_{pR2} =$	2.9 ksi	
layer 8	$\Delta f_{pR2} =$	2.9 ksi	
layer 9	$\Delta f_{pR2} =$	2.9 ksi	2.9 ksi
layer 10	$\Delta f_{pR2} =$		2.9 ksi
layer 11	$\Delta f_{pR2} =$		2.9 ksi
layer 12	$\Delta f_{pR2} =$		2.9 ksi
layer 13	$\Delta f_{pR2} =$		2.9 ksi
layer 14	$\Delta f_{pR2} =$		2.9 ksi

**TOTAL LOSSES AT TRANSFER**

total loss $\Delta f_{pES} = \Delta f_{pi}$		at midspan	at endspan
stress in tendons after transfer $f_{pt} = f_{pi} - \Delta f_{pi}$			
layer 1	$f_{pt} =$	199.3 ksi	199.9 ksi
layer 2	$f_{pt} =$	199.3 ksi	199.9 ksi
layer 3	$f_{pt} =$	199.3 ksi	199.9 ksi
layer 4	$f_{pt} =$	199.3 ksi	199.9 ksi
layer 5	$f_{pt} =$	199.3 ksi	199.9 ksi
layer 6	$f_{pt} =$	199.3 ksi	
layer 7	$f_{pt} =$	199.3 ksi	
layer 8	$f_{pt} =$	199.3 ksi	
layer 9	$f_{pt} =$	199.3 ksi	199.9 ksi
layer 10	$f_{pt} =$		199.9 ksi
layer 11	$f_{pt} =$		199.9 ksi
layer 12	$f_{pt} =$		199.9 ksi
layer 13	$f_{pt} =$		199.9 ksi
layer 14	$f_{pt} =$		199.9 ksi
force per strand = $f_{pi} \times$ strand area		at midspan	at endspan
layer 1	=	16.9 kips	17.0 kips
layer 2	=	16.9 kips	17.0 kips
layer 3	=	16.9 kips	17.0 kips
layer 4	=	16.9 kips	17.0 kips
layer 5	=	16.9 kips	17.0 kips
layer 6	=	16.9 kips	
layer 7	=	16.9 kips	
layer 8	=	16.9 kips	
layer 9	=	16.9 kips	17.0 kips
layer 10	=		17.0 kips
layer 11	=		17.0 kips
layer 12	=		17.0 kips
layer 13	=		17.0 kips
layer 14	=		17.0 kips
Total prestressing force after transfer	$P_i =$	1047.8 kips	1054.0 kips
Initial loss = $(\Delta f_{pi}) / (f_{pi})$		at midspan	at endspan
layer 1	% =	6.5%	6.2%
layer 2	% =	6.5%	6.2%
layer 3	% =	6.5%	6.2%
layer 4	% =	6.5%	6.2%
layer 5	% =	6.5%	6.2%
layer 6	% =	6.5%	
layer 7	% =	6.5%	
layer 8	% =	6.5%	
layer 9	% =	6.5%	6.2%
layer 10	% =		6.2%
layer 11	% =		6.2%
layer 12	% =		6.2%
layer 13	% =		6.2%
layer 14	% =		6.2%

OK  
OK  
OK  
OK  
OK  
OK  
OK  
OK  
OK  
OK  
OK  
OK  
OK  
OK  
OK



**TOTAL LOSSES AT SERVICE LOADS**

Total Losses		at midspan	at endspan
layer 1	$\Delta f_{pT} =$	41.1 ksi	40.5 ksi
layer 2	$\Delta f_{pT} =$	41.1 ksi	40.5 ksi
layer 3	$\Delta f_{pT} =$	41.1 ksi	40.5 ksi
layer 4	$\Delta f_{pT} =$	41.1 ksi	40.5 ksi
layer 5	$\Delta f_{pT} =$	41.1 ksi	40.5 ksi
layer 6	$\Delta f_{pT} =$	41.1 ksi	
layer 7	$\Delta f_{pT} =$	41.1 ksi	
layer 8	$\Delta f_{pT} =$	41.1 ksi	
layer 9	$\Delta f_{pT} =$	41.1 ksi	40.5 ksi
layer 10	$\Delta f_{pT} =$		40.5 ksi
layer 11	$\Delta f_{pT} =$		40.5 ksi
layer 12	$\Delta f_{pT} =$		40.5 ksi
layer 13	$\Delta f_{pT} =$		40.5 ksi
layer 14	$\Delta f_{pT} =$		40.5 ksi

Stress in tendon after all losses =  $f_{pi} - \Delta f_{pt}$

		at midspan	at endspan
layer 1	$f_{pe} =$	172.0 ksi	172.6 ksi
layer 2	$f_{pe} =$	172.0 ksi	172.6 ksi
layer 3	$f_{pe} =$	172.0 ksi	172.6 ksi
layer 4	$f_{pe} =$	172.0 ksi	172.6 ksi
layer 5	$f_{pe} =$	172.0 ksi	172.6 ksi
layer 6	$f_{pe} =$	172.0 ksi	
layer 7	$f_{pe} =$	172.0 ksi	
layer 8	$f_{pe} =$	172.0 ksi	
layer 9	$f_{pe} =$	172.0 ksi	172.6 ksi
layer 10	$f_{pe} =$		172.6 ksi
layer 11	$f_{pe} =$		172.6 ksi
layer 12	$f_{pe} =$		172.6 ksi
layer 13	$f_{pe} =$		172.6 ksi
layer 14	$f_{pe} =$		172.6 ksi

check prestressing stress limit at service limit state:  $f_{pe} \leq 0.8 \cdot f_{py}$

layer 1	=	205.4 ksi
layer 2	=	205.4 ksi
layer 3	=	205.4 ksi
layer 4	=	205.4 ksi
layer 5	=	205.4 ksi
layer 6	=	205.4 ksi
layer 7	=	205.4 ksi
layer 8	=	205.4 ksi
layer 9	=	205.4 ksi
layer 10	=	205.4 ksi
layer 11	=	205.4 ksi
layer 12	=	205.4 ksi
layer 13	=	205.4 ksi
layer 14	=	205.4 ksi

OK  
OK  
OK  
OK  
OK  
OK  
OK  
OK  
OK  
OK  
OK  
OK  
OK  
OK

force per strand =  $f_{pe} \cdot \text{strand area}$

		at midspan	at endspan
layer 1	=	14.6 kips	14.7 kips
layer 2	=	14.6 kips	14.7 kips
layer 3	=	14.6 kips	14.7 kips
layer 4	=	14.6 kips	14.7 kips
layer 5	=	14.6 kips	14.7 kips
layer 6	=	14.6 kips	
layer 7	=	14.6 kips	
layer 8	=	14.6 kips	
layer 9	=	14.6 kips	14.7 kips
layer 10	=		14.7 kips
layer 11	=		14.7 kips
layer 12	=		14.7 kips
layer 13	=		14.7 kips
layer 14	=		14.7 kips

		at midspan	at endspan
Total prestressing force after all losses	$P_{pe} =$	935.8 kips	939.1 kips
Final losses, % = $(\Delta f_{pT})/(f_{pi})$			
layer 1	% =	19.3%	19.0%
layer 2	% =	19.3%	19.0%
layer 3	% =	19.3%	19.0%
layer 4	% =	19.3%	19.0%
layer 5	% =	19.3%	19.0%
layer 6	% =	19.3%	
layer 7	% =	19.3%	
layer 8	% =	19.3%	
layer 9	% =	19.3%	19.0%
layer 10	% =		19.0%
layer 11	% =		19.0%
layer 12	% =		19.0%
layer 13	% =		19.0%
layer 14	% =		19.0%
Average final losses, %	% =	19.3%	19.0%

### Stresses at Transfer

#### STRESS LIMITS FOR CONCRETE

Compression = $0.6f_{ci}$	$f_{ci} =$	3.300 ksi
Tension		
without bonded reinforcement = $-0.0948\sqrt{f_{ci}} \leq -0.2$	=	-0.200 ksi
with bonded auxiliary reinforcement = $-0.22\sqrt{f_{ci}}$	=	-0.016 ksi

#### STRESSES AT TRANSFER LENGTH SECTION

Transfer Length = $60 \times (\text{strand diameter})$	=	1.9 ft	} Calcs for eccentricity (see 9.6.7.2)
Bending moment at transfer length	$M_g =$	87.7 ft-kips	
center of 12 strands to top fiber of beam at the end	=	7.00 in	
center of 12 strands to bottom fiber of beam at the harp point	=	11.00 in	
center of gravity of 32 strands and top fiber of beam at transfer length	=	9.84 in	
center of gravity of 32 strands and bottom fiber of beam	=	3.98 in	
center of gravity of all strands and the bottom fiber of beam at transfer length	=	15.24 in	
center of gravity of all strands and the bottom fiber of beam at the end	=	15.30 in	
Eccentricity of the strand group at transfer length:	$e_n =$	21.36 in	}
Eccentricity at end of beam:	$e =$	21.30 in	

$$f_t = \frac{P_i}{A} - \frac{P_i e}{S_t} + \frac{M_g}{S_t}$$

$$f_b = \frac{P_i}{A} + \frac{P_i e}{S_b} - \frac{M_g}{S_b}$$

		at midspan	at endspan	
Top stress at top fiber of beam	$f_t =$	-0.017 ksi	-0.017 ksi	OK
Bottom stress at bottom fiber of the beam	$f_b =$	2.906 ksi	2.906 ksi	OK

#### STRESSES AT HARP POINT

Bending moment due to beam weight at 0.3L	$M_g =$	1188.0 ft-kips		
Top stress at top fiber of beam	$f_t =$	0.173 ksi	0.169 ksi	OK
Bottom stress at bottom fiber of the beam	$f_b =$	2.736 ksi	2.621 ksi	OK

#### STRESSES AT MIDSPAN

Bending moment due to beam weight at 0.5L	$M_g =$	1414.3 ft-kips		
Top stress at top fiber of beam	$f_t =$	0.320 ksi	0.345 ksi	OK
Bottom stress at bottom fiber of the beam	$f_b =$	2.554 ksi	2.438 ksi	OK

### HOLD-DOWN FORCES

assume stress in strand before losses =  $0.8f_u$

layer 1	=	227.4 ksi
layer 2	=	227.4 ksi
layer 3	=	227.4 ksi
layer 4	=	227.4 ksi
layer 5	=	227.4 ksi
layer 6	=	227.4 ksi
layer 7	=	227.4 ksi
layer 8	=	227.4 ksi
layer 9	=	227.4 ksi
layer 10	=	227.4 ksi
layer 11	=	227.4 ksi
layer 12	=	227.4 ksi
layer 13	=	227.4 ksi
layer 14	=	227.4 ksi

prestress force per strand before any losses:

layer 1	=	19.3 kips
layer 2	=	19.3 kips
layer 3	=	19.3 kips
layer 4	=	19.3 kips
layer 5	=	19.3 kips
layer 6	=	19.3 kips
layer 7	=	19.3 kips
layer 8	=	19.3 kips
layer 9	=	19.3 kips
layer 10	=	19.3 kips
layer 11	=	19.3 kips
layer 12	=	19.3 kips
layer 13	=	19.3 kips
layer 14	=	19.3 kips
Harp Angle	$\psi$ =	7.2 °

Hold-down force/strand

layer 1	=	2.5 kips/strand
layer 2	=	2.5 kips/strand
layer 3	=	2.5 kips/strand
layer 4	=	2.5 kips/strand
layer 5	=	2.5 kips/strand
layer 6	=	2.5 kips/strand
layer 7	=	2.5 kips/strand
layer 8	=	2.5 kips/strand
layer 9	=	2.5 kips/strand
layer 10	=	2.5 kips/strand
layer 11	=	2.5 kips/strand
layer 12	=	2.5 kips/strand
layer 13	=	2.5 kips/strand
layer 14	=	2.5 kips/strand
Total hold-down force	=	30.45 kips

### Stresses at Service Loads

#### STRESS LIMITS FOR CONCRETE

##### Compression:

Due to permanent loads for load combination Service I

for the precast beam	=	3.150 ksi
for deck	=	1.463 ksi

Due to permanent and transient loads for load combination Service I

for the precast beam	=	4.200 ksi
for deck	=	1.950 ksi

##### Tension:

Load Combination Service III

for the precast beam	=	-0.016 ksi
----------------------	---	------------

STRESSES AT MIDSPAN			
Compression stresses at top fiber of beam		at midspan	at endspan
$f_s = \frac{F_{pe}}{A} - \frac{F_{pe}e}{S_t} + \frac{(M_D + M_L)}{S_t} + \frac{(M_{L2} + M_L)}{S_{L2}}$			
Due to permanent loads	$f_{ig} =$	2.108 ksi	2.106 ksi
$f_{s2} = \frac{F_{pe}}{A} - \frac{F_{pe}e}{S_t} + \frac{(M_D + M_L)}{S_t} + \frac{(M_{L2} + M_L)}{S_{L2}} + \frac{(M_{L+1})}{S_{L+1}}$			
Due to permanent loads and transient loads	$f_{ig} =$	2.547 ksi	2.545 ksi
Compression stresses at top fiber of deck		at midspan	at endspan
$f_{st} = \frac{(M_{L2} + M_L)}{S_{st}}$			
Due to permanent loads	$f_{ic} =$	0.041 ksi	0.041 ksi
$f_{st} = \frac{(M_{L2} + M_L + M_{L+1})}{S_{st}}$			
Due to permanent loads and transient loads	$f_{ic} =$	0.470 ksi	0.470 ksi
Tension stresses at top fiber of deck		at midspan	at endspan
$f_{st} = \frac{P_{pe}}{A} + \frac{F_{pe}e}{S_b} - \frac{(M_D + M_L)}{S_b} - \frac{(M_{L2}   M_L   0.8 * M_{L+1})}{S_{st}}$			
Load Combination Service III	$f_b =$	-0.804 ksi	-0.793 ksi

OK

OK

OK

OK

OK

**Strength Limit State**

POSITIVE MOMENT SECTION		
$M_u = 1.25DC + 1.5DW + 1.75(LL + IM)$	$M_u =$	8381.5 ft-kips
effective length factor for compression members		
layer 1	k =	0.27
layer 2	k =	0.27
layer 3	k =	0.27
layer 4	k =	0.27
layer 5	k =	0.27
layer 6	k =	0.27
layer 7	k =	0.27
layer 8	k =	0.27
layer 9	k =	0.27
layer 10	k =	0.27
layer 11	k =	0.27
layer 12	k =	0.27
layer 13	k =	0.27
layer 14	k =	0.27
	c =	5.6 ft-kips
average stress in prestressing steel		
layer 1	$f_{ps} =$	278.3 ksi
layer 2	$f_{ps} =$	278.3 ksi
layer 3	$f_{ps} =$	278.3 ksi
layer 4	$f_{ps} =$	278.3 ksi
layer 5	$f_{ps} =$	278.3 ksi
layer 6	$f_{ps} =$	278.3 ksi
layer 7	$f_{ps} =$	278.3 ksi
layer 8	$f_{ps} =$	278.3 ksi
layer 9	$f_{ps} =$	278.3 ksi
layer 10	$f_{ps} =$	278.3 ksi
layer 11	$f_{ps} =$	278.3 ksi
layer 12	$f_{ps} =$	278.3 ksi
layer 13	$f_{ps} =$	278.3 ksi
layer 14	$f_{ps} =$	278.3 ksi
nominal flexure resistance		
	a =	4.80 in
$M_r = \Phi M_n, \Phi = 1.00$	$\Phi M_n =$	9105.1 ft-kips
NEGATIVE MOMENT SECTION		
$M_u = 1.25DC + 1.5DW + 1.75(LL + IM)$	$M_u =$	-4837.2 ft-kips
	a =	0.19 in
	$\Phi M_n =$	4794.8 ft-kips

OK

NOT OK

### Shear Design

CRITICAL SECTION AT 0.59		
$V_u = 1.25DC + 1.5DW + 1.75(LL + IM)$	$V_u =$	405.0 kips
$M_u = 1.25DC + 1.5DW + 1.75(LL + IM)$	$M_u =$	-2684.4 ft-kips
or		
$V_u = 1.25DC + 1.5DW + 1.75(LL + IM)$	$V_u =$	364.8 kips
$M_u = 1.25DC + 1.5DW + 1.75(LL + IM)$	$M_u =$	-2877.0 ft-kips
max shear	$V_u =$	405.0 kips
max moment	$M_u =$	2877.0 ft-kips
Shear depth	$d_v =$	73.19 in
Applied factored normal force at the section	$N_u =$	0
Angle of diagonal compressive stresses	$\theta =$	36.00 °

### STRAIN IN FLEXURAL TENSION REINFORCEMENT

$$\epsilon_s = \frac{\frac{M_u}{d_v} + 0.5M_u + 0.5N_u \cot \theta - A_{ps}f_{ps}}{E_s A_s + E_p A_{ps}} \leq 0.002$$

	at midspan	at endspan	
resultant compressive stress at centroid	$f_{pc} =$	0.926 ksi	0.928 ksi
effective stress in prestressing strand after all losses			
layer 1	$f_{po} =$	176.7 ksi	177.4 ksi
layer 2	$f_{po} =$	176.7 ksi	177.4 ksi
layer 3	$f_{po} =$	176.7 ksi	177.4 ksi
layer 4	$f_{po} =$	176.7 ksi	177.4 ksi
layer 5	$f_{po} =$	176.7 ksi	
layer 6	$f_{po} =$	176.7 ksi	
layer 7	$f_{po} =$	176.7 ksi	
layer 8	$f_{po} =$	176.7 ksi	
layer 9	$f_{po} =$		177.4 ksi
layer 10	$f_{po} =$		177.4 ksi
layer 11	$f_{po} =$		177.4 ksi
layer 12	$f_{po} =$		177.4 ksi
layer 13	$f_{po} =$		177.4 ksi
layer 14	$f_{po} =$		177.4 ksi
strain in flexural tension			
		at midspan	at endspan
layer 1	$\epsilon_x =$	0.002000	0.002000
layer 2	$\epsilon_x =$	0.002000	0.002000
layer 3	$\epsilon_x =$	0.002000	0.002000
layer 4	$\epsilon_x =$	0.002000	0.002000
layer 5	$\epsilon_x =$	0.002000	
layer 6	$\epsilon_x =$	0.002000	
layer 7	$\epsilon_x =$	0.002000	
layer 8	$\epsilon_x =$	0.002000	
layer 9	$\epsilon_x =$		0.002000
layer 10	$\epsilon_x =$		0.002000
layer 11	$\epsilon_x =$		0.002000
layer 12	$\epsilon_x =$		0.002000
layer 13	$\epsilon_x =$		0.002000
layer 14	$\epsilon_x =$		0.002000

### Deflection and Camber

	at midspan	at endspan	
Deflection due to Prestressing Force at Transfer	$\Delta_p =$	3.27 in	0.62 in
Deflection due to Beam Self-Weight at Transfer	$\Delta_g =$	-1.49 in	
Deflection due to Beam Self-Weight at Erection	$\Delta_{g1} =$	-1.44 in	
Deflection due to Haunch and Deck	$\Delta_g =$	-1.95 in	
Deflection due to total self weight	$\Delta_{sw} =$	-0.11 in	
Total Deflection at transfer	$\Delta =$	1.79 in	-0.86 in
Total Deflection at erection	$\Delta =$	3.24 in	-1.53 in

### Deck Deflection (assuming 12" beam)

Deflection due to Deck Self-Weight	$\Delta_g =$	-1.1985 in
Live load deflection limit = span/800	$=$	0.18 in
Deflection due to live load and impact	$\Delta_L =$	-0.41 in

OK

**Location: Fire above Deck Between Girders**  
**Beam Design: 3/8" Strand**  
**Fire Exposure Status: 3 Hour**

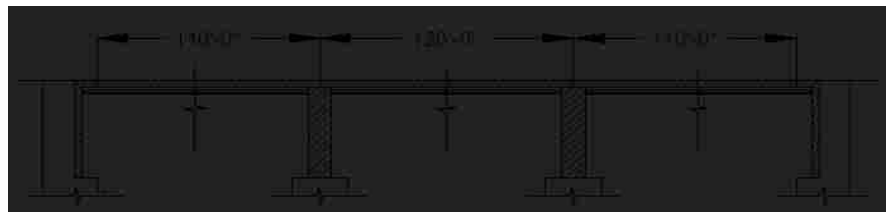
(PCI Bridge Design Manual Section 9.6)



**Material Properties**

CAST-IN-PLACE SLAB			
Actual Thickness	$t_{as} =$		8.0 in
Wearing Surface	=		0.5 in
Structural thickness = Actual - Wearing Surface	$t_s =$		7.5 in
Compressive Strength	$f'_c =$		3.02 ksi
Unit Weight	$w_c =$		150.0 pcf
Stress factor of compression block	$\beta_1 =$		0.85

BEAMS: AASHTO-PCI, BT-72 BULB-TEE			
Strength at release	$f_{ci} =$		5.5 ksi
Strength at 28 days	$f'_c =$		7 ksi
Unit Weight	$w_c =$		150.0 pcf
Overall Beam Length:			
@ end spans	$L =$		110 ft
@ center span	$L =$		119 ft
Design Spans:			
Non-composite beam @ end spans	$L =$		109 ft
Non-composite beam @ center span	$L =$		118 ft
Composite beam @ end spans	$L =$		110 ft
Composite beam @ center span	$L =$		120 ft
Beam Spacing	$S =$		12 ft



**PRESTRESSING STRANDS**

Diameter of single strand	d =	0.4 in
Area of single strand	A =	0.085 in <sup>2</sup>
Temperature of Layer		
	layer 1 (bottom)	T = 68.00 °F
	layer 2	T = 68.00 °F
	layer 3	T = 68.00 °F
	layer 4	T = 68.00 °F
	layer 5	T = 68.00 °F
	layer 6	T = 68.00 °F
	layer 7	T = 68.00 °F
	layer 8	T = 68.00 °F
	layer 9	T = 68.00 °F
	layer 10	T = 68.00 °F
	layer 11	T = 68.00 °F
	layer 12	T = 68.00 °F
	layer 13	T = 68.00 °F
	layer 14	T = 68.00 °F
Ultimate Strength		
initial = 284 ksi	layer 1 (bottom)	f <sub>pu</sub> = 284 ksi
	layer 2	f <sub>pu</sub> = 284 ksi
	layer 3	f <sub>pu</sub> = 284 ksi
	layer 4	f <sub>pu</sub> = 284 ksi
	layer 5	f <sub>pu</sub> = 284 ksi
	layer 6	f <sub>pu</sub> = 284 ksi
	layer 7	f <sub>pu</sub> = 284 ksi
	layer 8	f <sub>pu</sub> = 284 ksi
	layer 9	f <sub>pu</sub> = 284 ksi
	layer 10	f <sub>pu</sub> = 284 ksi
	layer 11	f <sub>pu</sub> = 284 ksi
	layer 12	f <sub>pu</sub> = 284 ksi
	layer 13	f <sub>pu</sub> = 284 ksi
	layer 14	f <sub>pu</sub> = 284 ksi
Yield Strength		
initial = 257 ksi	layer 1 (bottom)	f <sub>py</sub> = 257 ksi
	layer 2	f <sub>py</sub> = 257 ksi
	layer 3	f <sub>py</sub> = 257 ksi
	layer 4	f <sub>py</sub> = 257 ksi
	layer 5	f <sub>py</sub> = 257 ksi
	layer 6	f <sub>py</sub> = 257 ksi
	layer 7	f <sub>py</sub> = 257 ksi
	layer 8	f <sub>py</sub> = 257 ksi
	layer 9	f <sub>py</sub> = 257 ksi
	layer 10	f <sub>py</sub> = 257 ksi
	layer 11	f <sub>py</sub> = 257 ksi
	layer 12	f <sub>py</sub> = 257 ksi
	layer 13	f <sub>py</sub> = 257 ksi
	layer 14	f <sub>py</sub> = 257 ksi
<b>Stress Limits:</b>		
before transfer ≤ 0.75f <sub>pu</sub> (initial = 213.2)	layer 1 (bottom)	f <sub>pi</sub> = 213.2 ksi
	layer 2	f <sub>pi</sub> = 213.2 ksi
	layer 3	f <sub>pi</sub> = 213.2 ksi
	layer 4	f <sub>pi</sub> = 213.2 ksi
	layer 5	f <sub>pi</sub> = 213.2 ksi
	layer 6	f <sub>pi</sub> = 213.2 ksi
	layer 7	f <sub>pi</sub> = 213.2 ksi
	layer 8	f <sub>pi</sub> = 213.2 ksi
	layer 9	f <sub>pi</sub> = 213.2 ksi
	layer 10	f <sub>pi</sub> = 213.2 ksi
	layer 11	f <sub>pi</sub> = 213.2 ksi
	layer 12	f <sub>pi</sub> = 213.2 ksi
	layer 13	f <sub>pi</sub> = 213.2 ksi
	layer 14	f <sub>pi</sub> = 213.2 ksi

at service limit state (after all losses)  $\leq 0.80f_{py}$  (initial = 205.4)

layer 1 (bottom)	$f_{pe} =$	205.4 ksi
layer 2	$f_{pe} =$	205.4 ksi
layer 3	$f_{pe} =$	205.4 ksi
layer 4	$f_{pe} =$	205.4 ksi
layer 5	$f_{pe} =$	205.4 ksi
layer 6	$f_{pe} =$	205.4 ksi
layer 7	$f_{pe} =$	205.4 ksi
layer 8	$f_{pe} =$	205.4 ksi
layer 9	$f_{pe} =$	205.4 ksi
layer 10	$f_{pe} =$	205.4 ksi
layer 11	$f_{pe} =$	205.4 ksi
layer 12	$f_{pe} =$	205.4 ksi
layer 13	$f_{pe} =$	205.4 ksi
layer 14	$f_{pe} =$	205.4 ksi

Modulus of Elasticity

initial = 25898 ksi

layer 1 (bottom)	E =	25898.0 ksi
layer 2	E =	25898.0 ksi
layer 3	E =	25898.0 ksi
layer 4	E =	25898.0 ksi
layer 5	E =	25898.0 ksi
layer 6	E =	25898.0 ksi
layer 7	E =	25898.0 ksi
layer 8	E =	25898.0 ksi
layer 9	E =	25898.0 ksi
layer 10	E =	25898.0 ksi
layer 11	E =	25898.0 ksi
layer 12	E =	25898.0 ksi
layer 13	E =	25898.0 ksi
layer 14	E =	25898.0 ksi

#### MILD STEEL REINFORCING BARS AT ENDSpan

Yield Strength

Layer 1 (Bottom)	$f_y =$	60.0 ksi	68.00 °F
Layer 2 (Top)	$f_y =$	48.0 ksi	1300.00 °F

Modulus of Elasticity

Layer 1 (Bottom)	E =	29000.0 ksi
Layer 2 (Top)	E =	29000.0 ksi

Layer 1 (Bottom)

Area of steel at midspan (effective flange)	$A_{sm} =$	2.79 in <sup>2</sup>
Area of steel at endspan (effective flange)	$A_{se} =$	2.48 in <sup>2</sup>
Area of temperature and shrinkage steel (12" width)	$A_s =$	0.31 in <sup>2</sup>

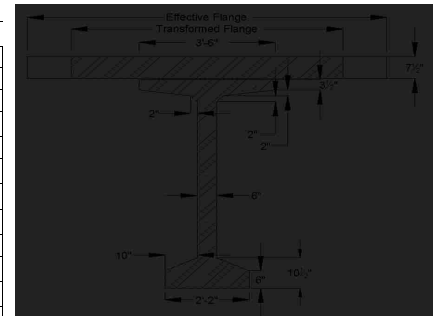
Layer 2 (Top)

Area of steel at midspan (effective flange)	$A_{sm} =$	12.6 in <sup>2</sup>
Area of steel at endspan (effective flange)	$A_{se} =$	12.4 in <sup>2</sup>
Area of temperature and shrinkage steel (12" width)	$A_s =$	0.2 in <sup>2</sup>

#### Cross-sectional Properties

##### NON-COMPOSITE BEAM

Area of cross-section of beam	A =	767.0 in <sup>2</sup>
Overall depth of beam	H =	72.0 in
Moment of Inertia	I =	539,947 in <sup>4</sup>
Distance from centroid to extreme <b>bottom</b> fiber	$y_b =$	36.6 in
Distance from centroid to extreme <b>top</b> fiber	$y_t =$	35.4 in
Section modulus for the extreme <b>bottom</b> fiber	$S_b =$	14915.0 in <sup>3</sup>
Section modulus for the extreme <b>top</b> fiber	$S_t =$	15421.0 in <sup>3</sup>
Weight	$W_t =$	799.0 plf
Modulus of Elasticity = $33000 \cdot (W_c^{1.5}) \cdot (\sqrt{f'_c})$		
cast-in-place concrete deck	$E_{cs} =$	3332 ksi
precast beam at release	$E_{ci} =$	4496 ksi
precast beam at service loads	$E_c =$	5072 ksi





### COMPOSITE BEAM

Effective Flange Width	$b_f =$	111.0 in	*min of three criteria
Modular Ratio = $E_{cs}/E_c$	$n =$	0.6568	
Transformed flange width	$=$	72.9 in	
Transformed flange area	$=$	546.8 in <sup>2</sup>	
Transformed haunch width	$=$	27.6 in	
Transformed haunch area	$=$	13.8 in <sup>2</sup>	

	Transformed Area	y <sub>b</sub>	Ay <sub>b</sub>	A(y <sub>bc</sub> -y <sub>b</sub> ) <sup>2</sup>	I	I + A(y <sub>bc</sub> -y <sub>b</sub> ) <sup>2</sup>
Beam	767.0 in <sup>2</sup>	36.60 in	28,072.2 in <sup>3</sup>	213,944 in <sup>4</sup>	539,947 in <sup>4</sup>	753,891 in <sup>4</sup>
Haunch	13.8 in <sup>2</sup>	72.25 in	996.6 in <sup>3</sup>	4,953 in <sup>4</sup>	0.33 in <sup>4</sup>	4,953 in <sup>4</sup>
Deck	546.8 in <sup>2</sup>	76.25 in	41,694.5 in <sup>3</sup>	287,973 in <sup>4</sup>	2,950 in <sup>4</sup>	290,922 in <sup>4</sup>
Total	1327.6 in <sup>2</sup>		70,763.3 in <sup>3</sup>			1,049,766 in <sup>4</sup>

Total area of Composite Section	$A_c =$	1328 in <sup>2</sup>
Overall Depth of the Composite Section	$h_c =$	80 in
Moment of Inertia	$I_c =$	1,049,766 in <sup>4</sup>
Distance from centroid to extreme <u>bottom</u> fiber of beam	$y_{bc} =$	53.30 in
Distance from centroid to extreme <u>top</u> fiber of beam	$y_{tb} =$	18.70 in
Distance from centroid to extreme <u>top</u> fiber of slab	$y_{tc} =$	26.70 in
Section modulus for the extreme <u>bottom</u> fiber of beam	$S_{bc} =$	19,694.9 in <sup>3</sup>
Section modulus for the extreme <u>top</u> fiber of beam	$S_{tb} =$	56,141.4 in <sup>3</sup>
Section modulus for the extreme <u>top</u> fiber slab	$S_{tc} =$	59,861.8 in <sup>3</sup>

### DECK (as 12" beam)

Reinforcing per 12"		at midspan	at beams
Layer 1 (Bottom)	$A_s =$	0.3 in <sup>2</sup>	0.3 in <sup>2</sup>
Layer 2 (Top)	$A_s =$	0.2 in <sup>2</sup>	0.2 in <sup>2</sup>

Modulus of Elasticity = $33000 \cdot (W_c^{1.5}) \cdot (\sqrt{f'_c})$	$E_{cs} =$	3332 ksi	
cast-in-place concrete deck			
Moment of Inertia	$I_g =$	125 in <sup>4</sup>	
Distance from centroid to extreme <u>bottom</u> fiber of deck	$y_b =$	2.38 in	
Distance from centroid to extreme <u>top</u> fiber of deck	$y_t =$	5.62 in	
Modulus of Rupture	$f_r =$	412.2 psi	
Cracking Moment	$M_{CR} =$	1.8 ft-kips	0.8 ft-kips
Max negative moment at loading stage	$M_a =$	16.9 ft-kips	21.1 ft-kips
Cracking Moment of Inertia	$I_{cr} =$	87 in <sup>4</sup>	87 in <sup>4</sup>
Effective Moment of Inertia	$I_e =$	87 in <sup>4</sup>	87 in <sup>4</sup>
Effective Moment of Inertia for Continuous Beam	$I_e =$	87 in <sup>4</sup>	

### Shear Forces and Bending Moments

#### DEAD LOADS

Beam self-weight	$W_{beam} =$	0.799 k/f
8 in. deck weight	$W_{deck} =$	1.200 k/f
1/2 in. haunch weight	$W_{haunch} =$	0.022 k/f

LRFD Specifications: Art. 4.6.2.2.1		
Width of Deck Constant		OK
Number of beams is not less than four $N_b =$	4	OK
Roadway part of the overhang, $d_o \leq 3.0$ ft, $d_o =$	1.5	OK
Curvature in plans is less than 4° =	0	OK
Cross-section of the bridge is consistent with one of the cross sections given by LRFD specs		OK

Barrier and wearing surface loads are equally distributed among the 4 beams

Barrier Wt	$W_t =$	0.150 k/f
Dead load of future wearing surface	$DW =$	0.263 k/f

LIVE LOADS		
Fire truck live load front load (Point A)	$P_{live} =$	48.0 kips
Fire truck live load back load (Point B)	$P_{live} =$	22.0 kips
distance between two loads		19.2 ft
distance from nearest edge to point A	$x_a =$	59.0 ft
distance from nearest edge to point B	$x_b =$	39.8 ft
LRFD Specifications: Art. 4.6.2.2.1		
Width of Deck Constant		OK
Number of beams is not less than four $N_b =$	4	OK
Beams are parallel and approximately of the same stiffness		OK
Roadway part of the overhang, $d_o \leq 3.0$ ft, $d_e =$	1.5	OK
Curvature in plans is less than $4^\circ =$	0	OK

Barrier and wearing surface loads are equally distributed among the 4 beams

Bridge Type-- "k" (LRFD Table 4.6.2.2.1-1)		
Number of design lanes = $w/12$	=	3 lanes

**Distribution Factor for Bending Moment:**

Beams spacing	$S =$	12.0 ft
Depth of concrete slab	$t_s =$	7.5 in
Beam Span	$L =$	120.0 ft
Number of Beams	$N_b =$	4
Modular ratio between beam & deck materials	$n =$	1.5225
Longitudinal stiffness parameter	$K_y =$	2,657,855.02 in <sup>4</sup>

at center span:		
$DFM = 0.75 + \left(\frac{S}{9.5}\right)^{0.6} * \left(\frac{S}{L}\right)^{0.2} * \left(\frac{K_y}{12 * L * t_s^3}\right)^{0.1}$		
DFM =		0.916 lanes/beam

0.905 Controls

one design lane loaded:		
$DFM = 0.75 + \left(\frac{S}{14}\right)^{0.6} * \left(\frac{S}{L}\right)^{0.3} * \left(\frac{K_y}{12 * L * t_s^3}\right)^{0.1}$		
DFM =		0.621 lanes/beam

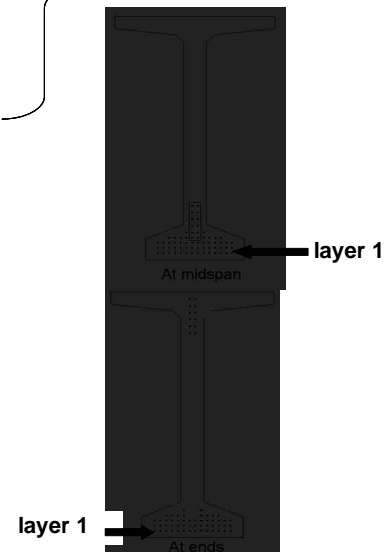
**Distribution Factor for Shear Force**

both end spans and center span:		
$DFV = 0.2 + \left(\frac{S}{12}\right) - \left(\frac{S}{35}\right)^2$		
DFV =		1.082 lanes/beam

1.082 Controls

one design lane loaded:		
$DFV = 0.36 + \left(\frac{S}{25}\right)$		
DFV =		0.840 lanes/beam

from bottom	At Midspan		At Ends	
	No. of	Distance from Bottom	No. of	Distance from Bottom
layer 1	14	2	14	2
layer 2	14	3.5	14	3.5
layer 3	14	5	14	5
layer 4	10	6.5	8	6.5
layer 5	4	8	2	8
layer 6	2	10	-	-
layer 7	2	12	-	-
layer 8	2	14	-	-
layer 9	2	16	2	60
layer 10	-	-	2	62
layer 11	-	-	2	64
layer 12	-	-	2	66
layer 13	-	-	2	68
layer 14	-	-	2	70
	64		64	
<b>Harped Strand Group (included in above totals)</b>				
layer 3	2	6		
layer 4	2	8		
layer 5	2	10		
layer 6	2	12		
layer 7	2	14		
layer 8	2	16		



distance from the center of gravity of strands to the bottom fiber of the beam = 7% of the beam depth  
strand eccentricity at midspan =  $(y_b - y_{bs})$

$y_{bs} =$	5.44 in
$e_c =$	31.16 in

### Prestress Losses

#### ELASTIC SHORTENING

assumed loss	=	6.00%
--------------	---	-------

Force per strand at transfer

layer 1	=	17.0 kips
layer 2	=	17.0 kips
layer 3	=	17.0 kips
layer 4	=	17.0 kips
layer 5	=	17.0 kips
layer 6	=	17.0 kips
layer 7	=	17.0 kips
layer 8	=	17.0 kips
layer 9	=	17.0 kips
layer 10	=	17.0 kips
layer 11	=	17.0 kips
layer 12	=	17.0 kips
layer 13	=	17.0 kips
layer 14	=	17.0 kips

Total prestressing force at release	$P_i =$	1088.0 kips	at midspan	1054.0 kips	at endspan
-------------------------------------	---------	-------------	------------	-------------	------------

Sum of concrete stresses at the center of gravity of prestressing tendons due to prestressing force at transfer and the self-weight of the member at sections of maximum moment

$f_{cgp} =$	2.412 ksi	2.307 ksi
-------------	-----------	-----------

Loss due to shortening

		at midspan	at endspan
layer 1	$\Delta f_{pES} =$	13.9 ksi	13.3 ksi
layer 2	$\Delta f_{pES} =$	13.9 ksi	13.3 ksi
layer 3	$\Delta f_{pES} =$	13.9 ksi	13.3 ksi
layer 4	$\Delta f_{pES} =$	13.9 ksi	13.3 ksi
layer 5	$\Delta f_{pES} =$	13.9 ksi	13.3 ksi
layer 6	$\Delta f_{pES} =$	13.9 ksi	
layer 7	$\Delta f_{pES} =$	13.9 ksi	
layer 8	$\Delta f_{pES} =$	13.9 ksi	
layer 9	$\Delta f_{pES} =$	13.9 ksi	13.3 ksi
layer 10	$\Delta f_{pES} =$		13.3 ksi
layer 11	$\Delta f_{pES} =$		13.3 ksi
layer 12	$\Delta f_{pES} =$		13.3 ksi
layer 13	$\Delta f_{pES} =$		13.3 ksi
layer 14	$\Delta f_{pES} =$		13.3 ksi

#### SHRINKAGE

Shrinkage =  $(17 - 0.15 \cdot \text{Relative Humidity})$

$\Delta f_{pSR} =$	6.5 ksi
--------------------	---------

← assume relative humidity = 70%

#### CREEP OF CONCRETE

Change of stresses at center of gravity of prestressing due to permanent loads except the loads acting at time of applying prestressing force, calculated at the same section as  $f_{cgp}$

$\Delta f_{cdp} =$	1.583 ksi	
--------------------	-----------	--

		at midspan	at endspan
loss due to creep	$\Delta f_{PCR} =$	17.9 ksi	16.6 ksi

**RELAXATION OF PRESTRESSING STRANDS**

loss due to relaxation after transfer		at midspan	at endspan
layer 1	$\Delta f_{pR2} =$	2.9 ksi	2.9 ksi
layer 2	$\Delta f_{pR2} =$	2.9 ksi	2.9 ksi
layer 3	$\Delta f_{pR2} =$	2.9 ksi	2.9 ksi
layer 4	$\Delta f_{pR2} =$	2.9 ksi	2.9 ksi
layer 5	$\Delta f_{pR2} =$	2.9 ksi	2.9 ksi
layer 6	$\Delta f_{pR2} =$	2.9 ksi	
layer 7	$\Delta f_{pR2} =$	2.9 ksi	
layer 8	$\Delta f_{pR2} =$	2.9 ksi	
layer 9	$\Delta f_{pR2} =$	2.9 ksi	2.9 ksi
layer 10	$\Delta f_{pR2} =$		2.9 ksi
layer 11	$\Delta f_{pR2} =$		2.9 ksi
layer 12	$\Delta f_{pR2} =$		2.9 ksi
layer 13	$\Delta f_{pR2} =$		2.9 ksi
layer 14	$\Delta f_{pR2} =$		2.9 ksi

**TOTAL LOSSES AT TRANSFER**

total loss $\Delta f_{pES} = \Delta f_{pi}$		at midspan	at endspan
stress in tendons after transfer $f_{pt} = f_{pi} - \Delta f_{pi}$			
layer 1	$f_{pt} =$	199.3 ksi	199.9 ksi
layer 2	$f_{pt} =$	199.3 ksi	199.9 ksi
layer 3	$f_{pt} =$	199.3 ksi	199.9 ksi
layer 4	$f_{pt} =$	199.3 ksi	199.9 ksi
layer 5	$f_{pt} =$	199.3 ksi	199.9 ksi
layer 6	$f_{pt} =$	199.3 ksi	
layer 7	$f_{pt} =$	199.3 ksi	
layer 8	$f_{pt} =$	199.3 ksi	
layer 9	$f_{pt} =$	199.3 ksi	199.9 ksi
layer 10	$f_{pt} =$		199.9 ksi
layer 11	$f_{pt} =$		199.9 ksi
layer 12	$f_{pt} =$		199.9 ksi
layer 13	$f_{pt} =$		199.9 ksi
layer 14	$f_{pt} =$		199.9 ksi
force per strand = $f_{pi} \times$ strand area		at midspan	at endspan
layer 1	=	16.9 kips	17.0 kips
layer 2	=	16.9 kips	17.0 kips
layer 3	=	16.9 kips	17.0 kips
layer 4	=	16.9 kips	17.0 kips
layer 5	=	16.9 kips	17.0 kips
layer 6	=	16.9 kips	
layer 7	=	16.9 kips	
layer 8	=	16.9 kips	
layer 9	=	16.9 kips	17.0 kips
layer 10	=		17.0 kips
layer 11	=		17.0 kips
layer 12	=		17.0 kips
layer 13	=		17.0 kips
layer 14	=		17.0 kips
Total prestressing force after transfer	$P_i =$	1047.8 kips	1054.0 kips
Initial loss = $(\Delta f_{pi}) / (f_{pi})$		at midspan	at endspan
layer 1	% =	6.5%	6.2%
layer 2	% =	6.5%	6.2%
layer 3	% =	6.5%	6.2%
layer 4	% =	6.5%	6.2%
layer 5	% =	6.5%	6.2%
layer 6	% =	6.5%	
layer 7	% =	6.5%	
layer 8	% =	6.5%	
layer 9	% =	6.5%	6.2%
layer 10	% =		6.2%
layer 11	% =		6.2%
layer 12	% =		6.2%
layer 13	% =		6.2%
layer 14	% =		6.2%

OK  
OK  
OK  
OK  
OK  
OK  
OK  
OK  
OK  
OK  
OK  
OK  
OK  
OK  
OK

**TOTAL LOSSES AT SERVICE LOADS**

Total Losses		at midspan	at endspan
layer 1	$\Delta f_{pT} =$	41.1 ksi	40.5 ksi
layer 2	$\Delta f_{pT} =$	41.1 ksi	40.5 ksi
layer 3	$\Delta f_{pT} =$	41.1 ksi	40.5 ksi
layer 4	$\Delta f_{pT} =$	41.1 ksi	40.5 ksi
layer 5	$\Delta f_{pT} =$	41.1 ksi	40.5 ksi
layer 6	$\Delta f_{pT} =$	41.1 ksi	
layer 7	$\Delta f_{pT} =$	41.1 ksi	
layer 8	$\Delta f_{pT} =$	41.1 ksi	
layer 9	$\Delta f_{pT} =$	41.1 ksi	40.5 ksi
layer 10	$\Delta f_{pT} =$		40.5 ksi
layer 11	$\Delta f_{pT} =$		40.5 ksi
layer 12	$\Delta f_{pT} =$		40.5 ksi
layer 13	$\Delta f_{pT} =$		40.5 ksi
layer 14	$\Delta f_{pT} =$		40.5 ksi

Stress in tendon after all losses =  $f_{pi} - \Delta f_{pt}$

		at midspan	at endspan
layer 1	$f_{pe} =$	172.0 ksi	172.6 ksi
layer 2	$f_{pe} =$	172.0 ksi	172.6 ksi
layer 3	$f_{pe} =$	172.0 ksi	172.6 ksi
layer 4	$f_{pe} =$	172.0 ksi	172.6 ksi
layer 5	$f_{pe} =$	172.0 ksi	172.6 ksi
layer 6	$f_{pe} =$	172.0 ksi	
layer 7	$f_{pe} =$	172.0 ksi	
layer 8	$f_{pe} =$	172.0 ksi	
layer 9	$f_{pe} =$	172.0 ksi	172.6 ksi
layer 10	$f_{pe} =$		172.6 ksi
layer 11	$f_{pe} =$		172.6 ksi
layer 12	$f_{pe} =$		172.6 ksi
layer 13	$f_{pe} =$		172.6 ksi
layer 14	$f_{pe} =$		172.6 ksi

check prestressing stress limit at service limit state:  $f_{pe} \leq 0.8 * f_{py}$

layer 1	=	205.4 ksi
layer 2	=	205.4 ksi
layer 3	=	205.4 ksi
layer 4	=	205.4 ksi
layer 5	=	205.4 ksi
layer 6	=	205.4 ksi
layer 7	=	205.4 ksi
layer 8	=	205.4 ksi
layer 9	=	205.4 ksi
layer 10	=	205.4 ksi
layer 11	=	205.4 ksi
layer 12	=	205.4 ksi
layer 13	=	205.4 ksi
layer 14	=	205.4 ksi

OK  
OK  
OK  
OK  
OK  
OK  
OK  
OK  
OK  
OK  
OK  
OK  
OK  
OK

force per strand =  $f_{pe} * \text{strand area}$

		at midspan	at endspan
layer 1	=	14.6 kips	14.7 kips
layer 2	=	14.6 kips	14.7 kips
layer 3	=	14.6 kips	14.7 kips
layer 4	=	14.6 kips	14.7 kips
layer 5	=	14.6 kips	14.7 kips
layer 6	=	14.6 kips	
layer 7	=	14.6 kips	
layer 8	=	14.6 kips	
layer 9	=	14.6 kips	14.7 kips
layer 10	=		14.7 kips
layer 11	=		14.7 kips
layer 12	=		14.7 kips
layer 13	=		14.7 kips
layer 14	=		14.7 kips

		at midspan	at endspan
Total prestressing force after all losses	$P_{pe} =$	935.8 kips	939.1 kips
Final losses, % = $(\Delta f_{pT})/(f_{pi})$			
layer 1	% =	19.3%	19.0%
layer 2	% =	19.3%	19.0%
layer 3	% =	19.3%	19.0%
layer 4	% =	19.3%	19.0%
layer 5	% =	19.3%	19.0%
layer 6	% =	19.3%	
layer 7	% =	19.3%	
layer 8	% =	19.3%	
layer 9	% =	19.3%	19.0%
layer 10	% =		19.0%
layer 11	% =		19.0%
layer 12	% =		19.0%
layer 13	% =		19.0%
layer 14	% =		19.0%
Average final losses, %	% =	19.3%	19.0%

### Stresses at Transfer

#### STRESS LIMITS FOR CONCRETE

Compression = $0.6f_{ci}$	$f_{ci} =$	3.300 ksi
Tension		
without bonded reinforcement = $-0.0948\sqrt{f_{ci}} \leq -0.2$	=	-0.200 ksi
with bonded auxiliary reinforcement = $-0.22\sqrt{f_{ci}}$	=	-0.016 ksi

#### STRESSES AT TRANSFER LENGTH SECTION

Transfer Length = $60 \times (\text{strand diameter})$	=	1.9 ft	} Calcs for eccentricity (see 9.6.7.2)
Bending moment at transfer length	$M_g =$	87.7 ft-kips	
center of 12 strands to top fiber of beam at the end	=	7.00 in	
center of 12 strands to bottom fiber of beam at the harp point	=	11.00 in	
center of gravity of 32 strands and top fiber of beam at transfer length	=	9.84 in	
center of gravity of 32 strands and bottom fiber of beam	=	3.98 in	
center of gravity of all strands and the bottom fiber of beam at transfer length	=	15.24 in	
center of gravity of all strands and the bottom fiber of beam at the end	=	15.30 in	
Eccentricity of the strand group at transfer length:	$e_n =$	21.36 in	}
Eccentricity at end of beam:	$e =$	21.30 in	

$$f_t = \frac{P_i}{A} - \frac{P_i e}{S_t} + \frac{M_g}{S_t}$$

$$f_b = \frac{P_i}{A} + \frac{P_i e}{S_b} - \frac{M_g}{S_b}$$

		at midspan	at endspan	
Top stress at top fiber of beam	$f_t =$	-0.017 ksi	-0.017 ksi	OK
Bottom stress at bottom fiber of the beam	$f_b =$	2.906 ksi	2.906 ksi	OK

#### STRESSES AT HARP POINT

Bending moment due to beam weight at 0.3L	$M_g =$	1188.0 ft-kips		
Top stress at top fiber of beam	$f_t =$	0.173 ksi	0.169 ksi	OK
Bottom stress at bottom fiber of the beam	$f_b =$	2.736 ksi	2.621 ksi	OK

#### STRESSES AT MIDSPAN

Bending moment due to beam weight at 0.5L	$M_g =$	1414.3 ft-kips		
Top stress at top fiber of beam	$f_t =$	0.320 ksi	0.345 ksi	OK
Bottom stress at bottom fiber of the beam	$f_b =$	2.554 ksi	2.438 ksi	OK

### HOLD-DOWN FORCES

assume stress in strand before losses =  $0.8f_u$

layer 1	=	227.4 ksi
layer 2	=	227.4 ksi
layer 3	=	227.4 ksi
layer 4	=	227.4 ksi
layer 5	=	227.4 ksi
layer 6	=	227.4 ksi
layer 7	=	227.4 ksi
layer 8	=	227.4 ksi
layer 9	=	227.4 ksi
layer 10	=	227.4 ksi
layer 11	=	227.4 ksi
layer 12	=	227.4 ksi
layer 13	=	227.4 ksi
layer 14	=	227.4 ksi

prestress force per strand before any losses:

layer 1	=	19.3 kips
layer 2	=	19.3 kips
layer 3	=	19.3 kips
layer 4	=	19.3 kips
layer 5	=	19.3 kips
layer 6	=	19.3 kips
layer 7	=	19.3 kips
layer 8	=	19.3 kips
layer 9	=	19.3 kips
layer 10	=	19.3 kips
layer 11	=	19.3 kips
layer 12	=	19.3 kips
layer 13	=	19.3 kips
layer 14	=	19.3 kips
Harp Angle	$\psi$ =	7.2 °

Hold-down force/strand

layer 1	=	2.5 kips/strand
layer 2	=	2.5 kips/strand
layer 3	=	2.5 kips/strand
layer 4	=	2.5 kips/strand
layer 5	=	2.5 kips/strand
layer 6	=	2.5 kips/strand
layer 7	=	2.5 kips/strand
layer 8	=	2.5 kips/strand
layer 9	=	2.5 kips/strand
layer 10	=	2.5 kips/strand
layer 11	=	2.5 kips/strand
layer 12	=	2.5 kips/strand
layer 13	=	2.5 kips/strand
layer 14	=	2.5 kips/strand
Total hold-down force	=	30.45 kips

### Stresses at Service Loads

#### STRESS LIMITS FOR CONCRETE

##### Compression:

Due to permanent loads for load combination Service I

for the precast beam	=	3.150 ksi
for deck	=	1.359 ksi

Due to permanent and transient loads for load combination Service I

for the precast beam	=	4.200 ksi
for deck	=	1.812 ksi

##### Tension:

Load Combination Service III

for the precast beam	=	-0.016 ksi
----------------------	---	------------

STRESSES AT MIDSPAN			
Compression stresses at top fiber of beam		at midspan	at endspan
$f_s = \frac{F_{ps}}{A} - \frac{F_{ps}e}{S_t} + \frac{(M_D + M_L)}{S_t} + \frac{(M_{L2} + M_L)}{S_{L2}}$			
Due to permanent loads	$f_{i0} =$	2.109 ksi	2.107 ksi
$f_{s2} = \frac{F_{ps}}{A} - \frac{F_{ps}e}{S_t} + \frac{(M_D + M_L)}{S_t} + \frac{(M_{L2} + M_L)}{S_{L2}} + \frac{(M_{L+1})}{S_{L+1}}$			
Due to permanent loads and transient loads	$f_{i0} =$	2.561 ksi	2.559 ksi
Compression stresses at top fiber of deck		at midspan	at endspan
$f_{st} = \frac{(M_{L2} + M_L)}{S_{st}}$			
Due to permanent loads	$f_{ic} =$	0.040 ksi	0.040 ksi
$f_{st} = \frac{(M_{L2} + M_L + M_{L+1})}{S_{st}}$			
Due to permanent loads and transient loads	$f_{ic} =$	0.464 ksi	0.464 ksi
Tension stresses at top fiber of deck		at midspan	at endspan
$f_{st} = \frac{P_{pe}}{A} + \frac{F_{ps}e}{S_b} - \frac{(M_D + M_L)}{S_b} - \frac{(M_{L2}   M_L   0.8 * M_{L+1})}{S_{st}}$			
Load Combination Service III	$f_b =$	-0.808 ksi	-0.797 ksi

OK

OK

OK

OK

OK

**Strength Limit State**

POSITIVE MOMENT SECTION		
$M_u = 1.25DC + 1.5DW + 1.75(LL + IM)$	$M_u =$	8381.5 ft-kips
effective length factor for compression members		
layer 1	k =	0.27
layer 2	k =	0.27
layer 3	k =	0.27
layer 4	k =	0.27
layer 5	k =	0.27
layer 6	k =	0.27
layer 7	k =	0.27
layer 8	k =	0.27
layer 9	k =	0.27
layer 10	k =	0.27
layer 11	k =	0.27
layer 12	k =	0.27
layer 13	k =	0.27
layer 14	k =	0.27
	c =	6.1 ft-kips
average stress in prestressing steel		
layer 1	$f_{ps} =$	277.9 ksi
layer 2	$f_{ps} =$	277.9 ksi
layer 3	$f_{ps} =$	277.9 ksi
layer 4	$f_{ps} =$	277.9 ksi
layer 5	$f_{ps} =$	277.9 ksi
layer 6	$f_{ps} =$	277.9 ksi
layer 7	$f_{ps} =$	277.9 ksi
layer 8	$f_{ps} =$	277.9 ksi
layer 9	$f_{ps} =$	277.9 ksi
layer 10	$f_{ps} =$	277.9 ksi
layer 11	$f_{ps} =$	277.9 ksi
layer 12	$f_{ps} =$	277.9 ksi
layer 13	$f_{ps} =$	277.9 ksi
layer 14	$f_{ps} =$	277.9 ksi
nominal flexure resistance		
	a =	5.16 in
$M_r = \Phi M_n, \Phi = 1.00$	$\Phi M_n =$	9068.2 ft-kips
NEGATIVE MOMENT SECTION		
$M_u = 1.25DC + 1.5DW + 1.75(LL + IM)$	$M_u =$	-4837.2 ft-kips
	a =	0.18 in
	$\Phi M_n =$	4410.7 ft-kips

OK

NOT OK



## Shear Design

CRITICAL SECTION AT 0.59		
$V_u = 1.25DC + 1.5DW + 1.75(LL + IM)$	$V_u =$	405.0 kips
$M_u = 1.25DC + 1.5DW + 1.75(LL + IM)$	$M_u =$	-2684.4 ft-kips
or		
$V_u = 1.25DC + 1.5DW + 1.75(LL + IM)$	$V_u =$	364.8 kips
$M_u = 1.25DC + 1.5DW + 1.75(LL + IM)$	$M_u =$	-2877.0 ft-kips
max shear	$V_u =$	405.0 kips
max moment	$M_u =$	2877.0 ft-kips
Shear depth	$d_v =$	73.19 in
Applied factored normal force at the section	$N_u =$	0
Angle of diagonal compressive stresses	$\theta =$	36.00 °

### STRAIN IN FLEXURAL TENSION REINFORCEMENT

$$\epsilon_s = \frac{\frac{M_u}{d_v} + 0.5M_u + 0.5N_u \cot \theta - A_{ps}f_{ps}}{E_s A_s + E_p A_{ps}} \leq 0.002$$

	at midspan	at endspan
resultant compressive stress at centroid	$f_{pc} =$	0.932 ksi
effective stress in prestressing strand after all losses		0.935 ksi
layer 1	$f_{po} =$	176.8 ksi
layer 2	$f_{po} =$	176.8 ksi
layer 3	$f_{po} =$	176.8 ksi
layer 4	$f_{po} =$	176.8 ksi
layer 5	$f_{po} =$	176.8 ksi
layer 6	$f_{po} =$	176.8 ksi
layer 7	$f_{po} =$	176.8 ksi
layer 8	$f_{po} =$	176.8 ksi
layer 9	$f_{po} =$	177.4 ksi
layer 10	$f_{po} =$	177.4 ksi
layer 11	$f_{po} =$	177.4 ksi
layer 12	$f_{po} =$	177.4 ksi
layer 13	$f_{po} =$	177.4 ksi
layer 14	$f_{po} =$	177.4 ksi

strain in flexural tension

	at midspan	at endspan
layer 1	$\epsilon_x =$	0.002000
layer 2	$\epsilon_x =$	0.002000
layer 3	$\epsilon_x =$	0.002000
layer 4	$\epsilon_x =$	0.002000
layer 5	$\epsilon_x =$	0.002000
layer 6	$\epsilon_x =$	0.002000
layer 7	$\epsilon_x =$	0.002000
layer 8	$\epsilon_x =$	0.002000
layer 9	$\epsilon_x =$	0.002000
layer 10	$\epsilon_x =$	0.002000
layer 11	$\epsilon_x =$	0.002000
layer 12	$\epsilon_x =$	0.002000
layer 13	$\epsilon_x =$	0.002000
layer 14	$\epsilon_x =$	0.002000

## Deflection and Camber

	at midspan	at endspan
Deflection due to Prestressing Force at Transfer	$\Delta_p =$	3.27 in
Deflection due to Beam Self-Weight at Transfer	$\Delta_{sw} =$	-1.49 in
Deflection due to Beam Self-Weight at Erection	$\Delta_{sw} =$	-1.44 in
Deflection due to Haunch and Deck	$\Delta_s =$	-1.95 in
Deflection due to total self weight	$\Delta_{sw} =$	-0.11 in
Total Deflection at transfer	$\Delta =$	1.79 in
Total Deflection at erection	$\Delta =$	-0.86 in
	$\Delta =$	3.24 in
	$\Delta =$	-1.53 in

### Deck Deflection (assuming 12" beam)

Deflection due to Deck Self-Weight	$\Delta_{sw} =$	-1.2443 in
Live load deflection limit = span/800	$=$	0.18 in
Deflection due to live load and impact	$\Delta_L =$	-0.55 in

OK

**Location: Fire above Deck Between Girders**  
**Beam Design: 3/8" Strand**  
**Fire Exposure Status: 4 Hour**

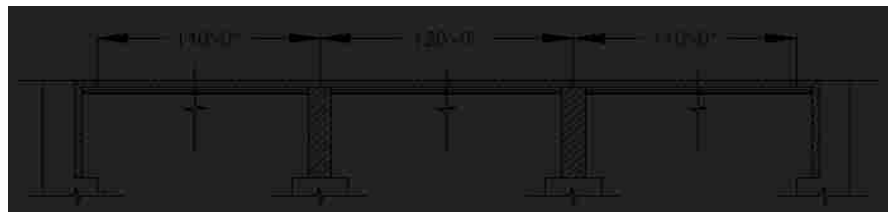
(PCI Bridge Design Manual Section 9.6)



**Material Properties**

CAST-IN-PLACE SLAB			
Actual Thickness	$t_{as} =$		8.0 in
Wearing Surface	$=$		0.5 in
Structural thickness = Actual - Wearing Surface	$t_s =$		7.5 in
Compressive Strength	$f_c =$		2.83 ksi
Unit Weight	$w_c =$		150.0 pcf
Stress factor of compression block	$\beta_1 =$		0.85

BEAMS: AASHTO-PCI, BT-72 BULB-TEE			
Strength at release	$f_{ci} =$		5.5 ksi
Strength at 28 days	$f_c =$		7 ksi
Unit Weight	$w_c =$		150.0 pcf
Overall Beam Length:			
@ end spans	$L =$		110 ft
@ center span	$L =$		119 ft
Design Spans:			
Non-composite beam @ end spans	$L =$		109 ft
Non-composite beam @ center span	$L =$		118 ft
Composite beam @ end spans	$L =$		110 ft
Composite beam @ center span	$L =$		120 ft
Beam Spacing	$S =$		12 ft



**PRESTRESSING STRANDS**

Diameter of single strand	d =	0.4 in
Area of single strand	A =	0.085 in <sup>2</sup>
Temperature of Layer		
	layer 1 (bottom)	T = 68.00 °F
	layer 2	T = 68.00 °F
	layer 3	T = 68.00 °F
	layer 4	T = 68.00 °F
	layer 5	T = 68.00 °F
	layer 6	T = 68.00 °F
	layer 7	T = 68.00 °F
	layer 8	T = 68.00 °F
	layer 9	T = 68.00 °F
	layer 10	T = 68.00 °F
	layer 11	T = 68.00 °F
	layer 12	T = 68.00 °F
	layer 13	T = 68.00 °F
	layer 14	T = 68.00 °F
Ultimate Strength		
initial = 284 ksi	layer 1 (bottom)	f <sub>pu</sub> = 284 ksi
	layer 2	f <sub>pu</sub> = 284 ksi
	layer 3	f <sub>pu</sub> = 284 ksi
	layer 4	f <sub>pu</sub> = 284 ksi
	layer 5	f <sub>pu</sub> = 284 ksi
	layer 6	f <sub>pu</sub> = 284 ksi
	layer 7	f <sub>pu</sub> = 284 ksi
	layer 8	f <sub>pu</sub> = 284 ksi
	layer 9	f <sub>pu</sub> = 284 ksi
	layer 10	f <sub>pu</sub> = 284 ksi
	layer 11	f <sub>pu</sub> = 284 ksi
	layer 12	f <sub>pu</sub> = 284 ksi
	layer 13	f <sub>pu</sub> = 284 ksi
	layer 14	f <sub>pu</sub> = 284 ksi
Yield Strength		
initial = 257 ksi	layer 1 (bottom)	f <sub>py</sub> = 257 ksi
	layer 2	f <sub>py</sub> = 257 ksi
	layer 3	f <sub>py</sub> = 257 ksi
	layer 4	f <sub>py</sub> = 257 ksi
	layer 5	f <sub>py</sub> = 257 ksi
	layer 6	f <sub>py</sub> = 257 ksi
	layer 7	f <sub>py</sub> = 257 ksi
	layer 8	f <sub>py</sub> = 257 ksi
	layer 9	f <sub>py</sub> = 257 ksi
	layer 10	f <sub>py</sub> = 257 ksi
	layer 11	f <sub>py</sub> = 257 ksi
	layer 12	f <sub>py</sub> = 257 ksi
	layer 13	f <sub>py</sub> = 257 ksi
	layer 14	f <sub>py</sub> = 257 ksi
<b>Stress Limits:</b>		
before transfer ≤ 0.75f <sub>pu</sub> (initial = 213.2)	layer 1 (bottom)	f <sub>pi</sub> = 213.2 ksi
	layer 2	f <sub>pi</sub> = 213.2 ksi
	layer 3	f <sub>pi</sub> = 213.2 ksi
	layer 4	f <sub>pi</sub> = 213.2 ksi
	layer 5	f <sub>pi</sub> = 213.2 ksi
	layer 6	f <sub>pi</sub> = 213.2 ksi
	layer 7	f <sub>pi</sub> = 213.2 ksi
	layer 8	f <sub>pi</sub> = 213.2 ksi
	layer 9	f <sub>pi</sub> = 213.2 ksi
	layer 10	f <sub>pi</sub> = 213.2 ksi
	layer 11	f <sub>pi</sub> = 213.2 ksi
	layer 12	f <sub>pi</sub> = 213.2 ksi
	layer 13	f <sub>pi</sub> = 213.2 ksi
	layer 14	f <sub>pi</sub> = 213.2 ksi

at service limit state (after all losses)  $\leq 0.80f_{py}$  (initial = 205.4)

layer 1 (bottom)	$f_{pe} =$	205.4 ksi
layer 2	$f_{pe} =$	205.4 ksi
layer 3	$f_{pe} =$	205.4 ksi
layer 4	$f_{pe} =$	205.4 ksi
layer 5	$f_{pe} =$	205.4 ksi
layer 6	$f_{pe} =$	205.4 ksi
layer 7	$f_{pe} =$	205.4 ksi
layer 8	$f_{pe} =$	205.4 ksi
layer 9	$f_{pe} =$	205.4 ksi
layer 10	$f_{pe} =$	205.4 ksi
layer 11	$f_{pe} =$	205.4 ksi
layer 12	$f_{pe} =$	205.4 ksi
layer 13	$f_{pe} =$	205.4 ksi
layer 14	$f_{pe} =$	205.4 ksi

Modulus of Elasticity

initial = 25898 ksi

layer 1 (bottom)	E =	25898.0 ksi
layer 2	E =	25898.0 ksi
layer 3	E =	25898.0 ksi
layer 4	E =	25898.0 ksi
layer 5	E =	25898.0 ksi
layer 6	E =	25898.0 ksi
layer 7	E =	25898.0 ksi
layer 8	E =	25898.0 ksi
layer 9	E =	25898.0 ksi
layer 10	E =	25898.0 ksi
layer 11	E =	25898.0 ksi
layer 12	E =	25898.0 ksi
layer 13	E =	25898.0 ksi
layer 14	E =	25898.0 ksi

### MILD STEEL REINFORCING BARS AT ENDSPAN

Yield Strength

Layer 1 (Bottom)	$f_y =$	60.0 ksi	100.00 °F
Layer 2 (Top)	$f_y =$	44.4 ksi	1430.00 °F

Modulus of Elasticity

Layer 1 (Bottom)	E =	29000.0 ksi
Layer 2 (Top)	E =	29000.0 ksi

Layer 1 (Bottom)

Area of steel at midspan (effective flange)	$A_{sm} =$	2.79 in <sup>2</sup>
Area of steel at endspan (effective flange)	$A_{se} =$	2.48 in <sup>2</sup>
Area of temperature and shrinkage steel (12" width)	$A_s =$	0.31 in <sup>2</sup>

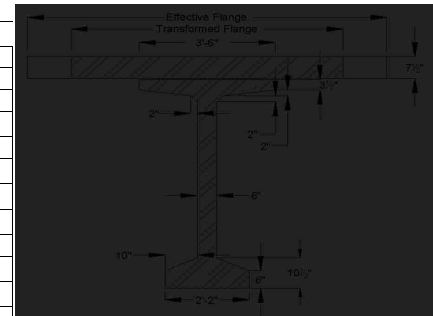
Layer 2 (Top)

Area of steel at midspan (effective flange)	$A_{sm} =$	12.6 in <sup>2</sup>
Area of steel at endspan (effective flange)	$A_{se} =$	12.4 in <sup>2</sup>
Area of temperature and shrinkage steel (12" width)	$A_s =$	0.2 in <sup>2</sup>

### Cross-sectional Properties

#### NON-COMPOSITE BEAM

Area of cross-section of beam	A =	767.0 in <sup>2</sup>
Overall depth of beam	H =	72.0 in
Moment of Inertia	I =	539,947 in <sup>4</sup>
Distance from centroid to extreme <b>bottom</b> fiber	$y_b =$	36.6 in
Distance from centroid to extreme <b>top</b> fiber	$y_t =$	35.4 in
Section modulus for the extreme <b>bottom</b> fiber	$S_b =$	14915.0 in <sup>3</sup>
Section modulus for the extreme <b>top</b> fiber	$S_t =$	15421.0 in <sup>3</sup>
Weight	$W_t =$	799.0 plf
Modulus of Elasticity = $33000 \cdot (W_c^{1.5}) \cdot (\sqrt{f'_c})$		
cast-in-place concrete deck	$E_{cs} =$	3225 ksi
precast beam at release	$E_{ci} =$	4496 ksi
precast beam at service loads	$E_c =$	5072 ksi



### COMPOSITE BEAM

Effective Flange Width	$b_f =$	111.0 in	*min of three criteria
Modular Ratio = $E_{cs}/E_c$	$n =$	0.6358	
Transformed flange width	$=$	70.6 in	
Transformed flange area	$=$	529.3 in <sup>2</sup>	
Transformed haunch width	$=$	26.7 in	
Transformed haunch area	$=$	13.4 in <sup>2</sup>	

	Transformed Area	y <sub>b</sub>	Ay <sub>b</sub>	A(y <sub>bc</sub> -y <sub>b</sub> ) <sup>2</sup>	I	I + A(y <sub>bc</sub> -y <sub>b</sub> ) <sup>2</sup>
Beam	767.0 in <sup>2</sup>	36.60 in	28,072.2 in <sup>3</sup>	206,008 in <sup>4</sup>	539,947 in <sup>4</sup>	745,955 in <sup>4</sup>
Haunch	13.4 in <sup>2</sup>	72.25 in	964.7 in <sup>3</sup>	4,954 in <sup>4</sup>	0.33 in <sup>4</sup>	4,954 in <sup>4</sup>
Deck	529.3 in <sup>2</sup>	76.25 in	40,361.6 in <sup>3</sup>	286,415 in <sup>4</sup>	2,950 in <sup>4</sup>	289,365 in <sup>4</sup>
Total	1309.7 in <sup>2</sup>		69,398.5 in <sup>3</sup>			1,040,274 in <sup>4</sup>

Total area of Composite Section	$A_c =$	1310 in <sup>2</sup>
Overall Depth of the Composite Section	$h_c =$	80 in
Moment of Inertia	$I_c =$	1,040,274 in <sup>4</sup>
Distance from centroid to extreme <u>bottom</u> fiber of beam	$y_{bc} =$	52.99 in
Distance from centroid to extreme <u>top</u> fiber of beam	$y_{tb} =$	19.01 in
Distance from centroid to extreme <u>top</u> fiber of slab	$y_{tc} =$	27.01 in
Section modulus for the extreme <u>bottom</u> fiber of beam	$S_{bc} =$	19,632.0 in <sup>3</sup>
Section modulus for the extreme <u>top</u> fiber of beam	$S_{tb} =$	54,718.8 in <sup>3</sup>
Section modulus for the extreme <u>top</u> fiber slab	$S_{tc} =$	60,570.1 in <sup>3</sup>

### DECK (as 12" beam)

Reinforcing per 12"		at midspan	at beams
Layer 1 (Bottom)	$A_s =$	0.3 in <sup>2</sup>	0.3 in <sup>2</sup>
Layer 2 (Top)	$A_s =$	0.2 in <sup>2</sup>	0.2 in <sup>2</sup>

Modulus of Elasticity = $33000 \cdot (W_c^{1.5}) \cdot (\sqrt{f'_c})$	$E_{cs} =$	3225 ksi	
cast-in-place concrete deck			
Moment of Inertia	$I_g =$	99 in <sup>4</sup>	
Distance from centroid to extreme <u>bottom</u> fiber of deck	$y_b =$	2.17 in	
Distance from centroid to extreme <u>top</u> fiber of deck	$y_t =$	5.83 in	
Modulus of Rupture	$f_r =$	399.0 psi	
Cracking Moment	$M_{CR} =$	1.5 ft-kips	0.6 ft-kips
Max negative moment at loading stage	$M_a =$	16.9 ft-kips	21.1 ft-kips
Cracking Moment of Inertia	$I_{cr} =$	87 in <sup>4</sup>	87 in <sup>4</sup>
Effective Moment of Inertia	$I_e =$	87 in <sup>4</sup>	87 in <sup>4</sup>
Effective Moment of Inertia for Continuous Beam	$I_e =$	87 in <sup>4</sup>	

### Shear Forces and Bending Moments

#### DEAD LOADS

Beam self-weight	$W_{beam} =$	0.799 k/f
8 in. deck weight	$W_{deck} =$	1.200 k/f
1/2 in. haunch weight	$W_{haunch} =$	0.022 k/f

LRFD Specifications: Art. 4.6.2.2.1		
Width of Deck Constant		OK
Number of beams is not less than four $N_b =$	4	OK
Roadway part of the overhang, $d_o \leq 3.0$ ft, $d_o =$	1.5	OK
Curvature in plans is less than 4° =	0	OK
Cross-section of the bridge is consistent with one of the cross sections given by LRFD specs		OK

Barrier and wearing surface loads are equally distributed among the 4 beams

Barrier Wt	$W_t =$	0.150 k/f
Dead load of future wearing surface	$DW =$	0.263 k/f

LIVE LOADS		
Fire truck live load front load (Point A)	$P_{live} =$	48.0 kips
Fire truck live load back load (Point B)	$P_{live} =$	22.0 kips
distance between two loads		19.2 ft
distance from nearest edge to point A	$x_a =$	59.0 ft
distance from nearest edge to point B	$x_b =$	39.8 ft
LRFD Specifications: Art. 4.6.2.2.1		
Width of Deck Constant		OK
Number of beams is not less than four $N_b =$	4	OK
Beams are parallel and approximately of the same stiffness		OK
Roadway part of the overhang, $d_o \leq 3.0$ ft, $d_o =$	1.5	OK
Curvature in plans is less than $4^\circ =$	0	OK

Barrier and wearing surface loads are equally distributed among the 4 beams

Bridge Type-- "k" (LRFD Table 4.6.2.2.1-1)

Number of design lanes = $w/12$	=	3 lanes
---------------------------------	---	---------

**Distribution Factor for Bending Moment:**

Beams spacing	$S =$	12.0 ft
Depth of concrete slab	$t_s =$	7.5 in
Beam Span	$L =$	120.0 ft
Number of Beams	$N_b =$	4
Modular ratio between beam & deck materials	$n =$	1.5727
Longitudinal stiffness parameter	$K_y =$	2,745,627.03 in <sup>4</sup>

at center span:

$$DFM = 0.75 + \left(\frac{S}{9.5}\right)^{0.6} * \left(\frac{S}{L}\right)^{0.2} * \left(\frac{K_y}{12 * L * t_s^3}\right)^{0.1}$$

DFM =	0.919 lanes/beam
-------	------------------

0.905 Controls

one design lane loaded:

$$DFM = 0.75 + \left(\frac{S}{14}\right)^{0.6} * \left(\frac{S}{L}\right)^{0.3} * \left(\frac{K_y}{12 * L * t_s^3}\right)^{0.1}$$

DFM =	0.623 lanes/beam
-------	------------------

**Distribution Factor for Shear Force**

both end spans and center span:

$$DFV = 0.2 + \left(\frac{S}{12}\right) - \left(\frac{S}{35}\right)^2$$

DFV =	1.082 lanes/beam
-------	------------------

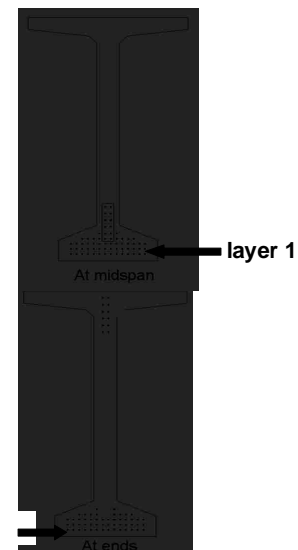
1.082 Controls

one design lane loaded:

$$DFV = 0.36 + \left(\frac{S}{25}\right)$$

DFV =	0.840 lanes/beam
-------	------------------

from bottom	At Midspan		At Ends	
	No. of	Distance from Bottom	No. of	Distance from Bottom
layer 1	14	2	14	2
layer 2	14	3.5	14	3.5
layer 3	14	5	14	5
layer 4	10	6.5	8	6.5
layer 5	4	8	2	8
layer 6	2	10	-	-
layer 7	2	12	-	-
layer 8	2	14	-	-
layer 9	2	16	2	60
layer 10	-	-	2	62
layer 11	-	-	2	64
layer 12	-	-	2	66
layer 13	-	-	2	68
layer 14	-	-	2	70
	64		64	
<b>Harped Strand Group (included in above totals)</b>				
layer 3	2	6		
layer 4	2	8		
layer 5	2	10		
layer 6	2	12		
layer 7	2	14		
layer 8	2	16		



layer 1

distance from the center of gravity of strands to the bottom fiber of the beam = 7% of the beam depth  
strand eccentricity at midspan =  $(y_b - y_{bs})$

$y_{bs} =$	5.44 in
$e_c =$	31.16 in

### Prestress Losses

#### ELASTIC SHORTENING

assumed loss	=	6.00%
--------------	---	-------

Force per strand at transfer

layer 1	=	17.0 kips
layer 2	=	17.0 kips
layer 3	=	17.0 kips
layer 4	=	17.0 kips
layer 5	=	17.0 kips
layer 6	=	17.0 kips
layer 7	=	17.0 kips
layer 8	=	17.0 kips
layer 9	=	17.0 kips
layer 10	=	17.0 kips
layer 11	=	17.0 kips
layer 12	=	17.0 kips
layer 13	=	17.0 kips
layer 14	=	17.0 kips

Total prestressing force at release	$P_i =$	1088.0 kips	at midspan	1054.0 kips	at endspan
-------------------------------------	---------	-------------	------------	-------------	------------

Sum of concrete stresses at the center of gravity of prestressing tendons due to prestressing force at transfer and the self-weight of the member at sections of maximum moment

$f_{cgp} =$	2.412 ksi	2.307 ksi
-------------	-----------	-----------

Loss due to shortening

		at midspan	at endspan
layer 1	$\Delta f_{pES} =$	13.9 ksi	13.3 ksi
layer 2	$\Delta f_{pES} =$	13.9 ksi	13.3 ksi
layer 3	$\Delta f_{pES} =$	13.9 ksi	13.3 ksi
layer 4	$\Delta f_{pES} =$	13.9 ksi	13.3 ksi
layer 5	$\Delta f_{pES} =$	13.9 ksi	13.3 ksi
layer 6	$\Delta f_{pES} =$	13.9 ksi	
layer 7	$\Delta f_{pES} =$	13.9 ksi	
layer 8	$\Delta f_{pES} =$	13.9 ksi	
layer 9	$\Delta f_{pES} =$	13.9 ksi	13.3 ksi
layer 10	$\Delta f_{pES} =$		13.3 ksi
layer 11	$\Delta f_{pES} =$		13.3 ksi
layer 12	$\Delta f_{pES} =$		13.3 ksi
layer 13	$\Delta f_{pES} =$		13.3 ksi
layer 14	$\Delta f_{pES} =$		13.3 ksi

#### SHRINKAGE

Shrinkage =  $(17 - 0.15 \times \text{Relative Humidity})$

$\Delta f_{pSR} =$	6.5 ksi
--------------------	---------

← assume relative humidity = 70%

#### CREEP OF CONCRETE

Change of stresses at center of gravity of prestressing due to permanent loads except the loads acting at time of applying prestressing force, calculated at the same section as  $f_{cgp}$

$\Delta f_{cdp} =$	1.583 ksi	
--------------------	-----------	--

		at midspan	at endspan
loss due to creep	$\Delta f_{PCR} =$	17.9 ksi	16.6 ksi

**RELAXATION OF PRESTRESSING STRANDS**

loss due to relaxation after transfer		at midspan	at endspan
layer 1	$\Delta f_{pR2} =$	2.9 ksi	2.9 ksi
layer 2	$\Delta f_{pR2} =$	2.9 ksi	2.9 ksi
layer 3	$\Delta f_{pR2} =$	2.9 ksi	2.9 ksi
layer 4	$\Delta f_{pR2} =$	2.9 ksi	2.9 ksi
layer 5	$\Delta f_{pR2} =$	2.9 ksi	2.9 ksi
layer 6	$\Delta f_{pR2} =$	2.9 ksi	
layer 7	$\Delta f_{pR2} =$	2.9 ksi	
layer 8	$\Delta f_{pR2} =$	2.9 ksi	
layer 9	$\Delta f_{pR2} =$	2.9 ksi	2.9 ksi
layer 10	$\Delta f_{pR2} =$		2.9 ksi
layer 11	$\Delta f_{pR2} =$		2.9 ksi
layer 12	$\Delta f_{pR2} =$		2.9 ksi
layer 13	$\Delta f_{pR2} =$		2.9 ksi
layer 14	$\Delta f_{pR2} =$		2.9 ksi

**TOTAL LOSSES AT TRANSFER**

total loss $\Delta f_{pES} = \Delta f_{pi}$		at midspan	at endspan
stress in tendons after transfer $f_{pt} = f_{pi} - \Delta f_{pi}$			
layer 1	$f_{pt} =$	199.3 ksi	199.9 ksi
layer 2	$f_{pt} =$	199.3 ksi	199.9 ksi
layer 3	$f_{pt} =$	199.3 ksi	199.9 ksi
layer 4	$f_{pt} =$	199.3 ksi	199.9 ksi
layer 5	$f_{pt} =$	199.3 ksi	199.9 ksi
layer 6	$f_{pt} =$	199.3 ksi	
layer 7	$f_{pt} =$	199.3 ksi	
layer 8	$f_{pt} =$	199.3 ksi	
layer 9	$f_{pt} =$	199.3 ksi	199.9 ksi
layer 10	$f_{pt} =$		199.9 ksi
layer 11	$f_{pt} =$		199.9 ksi
layer 12	$f_{pt} =$		199.9 ksi
layer 13	$f_{pt} =$		199.9 ksi
layer 14	$f_{pt} =$		199.9 ksi
force per strand = $f_{pi} \times$ strand area		at midspan	at endspan
layer 1	=	16.9 kips	17.0 kips
layer 2	=	16.9 kips	17.0 kips
layer 3	=	16.9 kips	17.0 kips
layer 4	=	16.9 kips	17.0 kips
layer 5	=	16.9 kips	17.0 kips
layer 6	=	16.9 kips	
layer 7	=	16.9 kips	
layer 8	=	16.9 kips	
layer 9	=	16.9 kips	17.0 kips
layer 10	=		17.0 kips
layer 11	=		17.0 kips
layer 12	=		17.0 kips
layer 13	=		17.0 kips
layer 14	=		17.0 kips
Total prestressing force after transfer	$P_i =$	1047.8 kips	1054.0 kips
Initial loss = $(\Delta f_{pi}) / (f_{pi})$		at midspan	at endspan
layer 1	% =	6.5%	6.2%
layer 2	% =	6.5%	6.2%
layer 3	% =	6.5%	6.2%
layer 4	% =	6.5%	6.2%
layer 5	% =	6.5%	6.2%
layer 6	% =	6.5%	
layer 7	% =	6.5%	
layer 8	% =	6.5%	
layer 9	% =	6.5%	6.2%
layer 10	% =		6.2%
layer 11	% =		6.2%
layer 12	% =		6.2%
layer 13	% =		6.2%
layer 14	% =		6.2%

OK  
OK  
OK  
OK  
OK  
OK  
OK  
OK  
OK  
OK  
OK  
OK  
OK  
OK  
OK



**TOTAL LOSSES AT SERVICE LOADS**

Total Losses		at midspan	at endspan
layer 1	$\Delta f_{pT} =$	41.1 ksi	40.5 ksi
layer 2	$\Delta f_{pT} =$	41.1 ksi	40.5 ksi
layer 3	$\Delta f_{pT} =$	41.1 ksi	40.5 ksi
layer 4	$\Delta f_{pT} =$	41.1 ksi	40.5 ksi
layer 5	$\Delta f_{pT} =$	41.1 ksi	40.5 ksi
layer 6	$\Delta f_{pT} =$	41.1 ksi	
layer 7	$\Delta f_{pT} =$	41.1 ksi	
layer 8	$\Delta f_{pT} =$	41.1 ksi	
layer 9	$\Delta f_{pT} =$	41.1 ksi	40.5 ksi
layer 10	$\Delta f_{pT} =$		40.5 ksi
layer 11	$\Delta f_{pT} =$		40.5 ksi
layer 12	$\Delta f_{pT} =$		40.5 ksi
layer 13	$\Delta f_{pT} =$		40.5 ksi
layer 14	$\Delta f_{pT} =$		40.5 ksi

Stress in tendon after all losses =  $f_{pi} - \Delta f_{pt}$

		at midspan	at endspan
layer 1	$f_{pe} =$	172.0 ksi	172.6 ksi
layer 2	$f_{pe} =$	172.0 ksi	172.6 ksi
layer 3	$f_{pe} =$	172.0 ksi	172.6 ksi
layer 4	$f_{pe} =$	172.0 ksi	172.6 ksi
layer 5	$f_{pe} =$	172.0 ksi	172.6 ksi
layer 6	$f_{pe} =$	172.0 ksi	
layer 7	$f_{pe} =$	172.0 ksi	
layer 8	$f_{pe} =$	172.0 ksi	
layer 9	$f_{pe} =$	172.0 ksi	172.6 ksi
layer 10	$f_{pe} =$		172.6 ksi
layer 11	$f_{pe} =$		172.6 ksi
layer 12	$f_{pe} =$		172.6 ksi
layer 13	$f_{pe} =$		172.6 ksi
layer 14	$f_{pe} =$		172.6 ksi

check prestressing stress limit at service limit state:  $f_{pe} \leq 0.8 \cdot f_{py}$

layer 1	=	205.4 ksi
layer 2	=	205.4 ksi
layer 3	=	205.4 ksi
layer 4	=	205.4 ksi
layer 5	=	205.4 ksi
layer 6	=	205.4 ksi
layer 7	=	205.4 ksi
layer 8	=	205.4 ksi
layer 9	=	205.4 ksi
layer 10	=	205.4 ksi
layer 11	=	205.4 ksi
layer 12	=	205.4 ksi
layer 13	=	205.4 ksi
layer 14	=	205.4 ksi

OK  
OK  
OK  
OK  
OK  
OK  
OK  
OK  
OK  
OK  
OK  
OK  
OK  
OK

force per strand =  $f_{pe} \cdot \text{strand area}$

		at midspan	at endspan
layer 1	=	14.6 kips	14.7 kips
layer 2	=	14.6 kips	14.7 kips
layer 3	=	14.6 kips	14.7 kips
layer 4	=	14.6 kips	14.7 kips
layer 5	=	14.6 kips	14.7 kips
layer 6	=	14.6 kips	
layer 7	=	14.6 kips	
layer 8	=	14.6 kips	
layer 9	=	14.6 kips	14.7 kips
layer 10	=		14.7 kips
layer 11	=		14.7 kips
layer 12	=		14.7 kips
layer 13	=		14.7 kips
layer 14	=		14.7 kips

		at midspan	at endspan
Total prestressing force after all losses	$P_{pe} =$	935.8 kips	939.1 kips
Final losses, % = $(\Delta f_{pT})/(f_{pi})$			
layer 1	% =	19.3%	19.0%
layer 2	% =	19.3%	19.0%
layer 3	% =	19.3%	19.0%
layer 4	% =	19.3%	19.0%
layer 5	% =	19.3%	19.0%
layer 6	% =	19.3%	
layer 7	% =	19.3%	
layer 8	% =	19.3%	
layer 9	% =	19.3%	19.0%
layer 10	% =		19.0%
layer 11	% =		19.0%
layer 12	% =		19.0%
layer 13	% =		19.0%
layer 14	% =		19.0%
Average final losses, %	% =	19.3%	19.0%

### Stresses at Transfer

#### STRESS LIMITS FOR CONCRETE

Compression = $0.6f_{ci}$	$f_{ci} =$	3.300 ksi
Tension		
without bonded reinforcement = $-0.0948\sqrt{f_{ci}} \leq -0.2$	=	-0.200 ksi
with bonded auxiliary reinforcement = $-0.22\sqrt{f_{ci}}$	=	-0.016 ksi

#### STRESSES AT TRANSFER LENGTH SECTION

Transfer Length = $60 \times (\text{strand diameter})$	=	1.9 ft	} Calcs for eccentricity (see 9.6.7.2)
Bending moment at transfer length	$M_g =$	87.7 ft-kips	
center of 12 strands to top fiber of beam at the end	=	7.00 in	
center of 12 strands to bottom fiber of beam at the harp point	=	11.00 in	
center of gravity of 12 strands and top fiber of beam at transfer length	=	9.84 in	
center of gravity of 32 strands and bottom fiber of beam	=	3.98 in	
center of gravity of all strands and the bottom fiber of beam at transfer length	=	15.24 in	
center of gravity of all strands and the bottom fiber of beam at the end	=	15.30 in	
Eccentricity of the strand group at transfer length:	$e_n =$	21.36 in	}
Eccentricity at end of beam:	$e =$	21.30 in	

$$f_t = \frac{P_i}{A} - \frac{P_i e}{S_t} + \frac{M_g}{S_t}$$

$$f_b = \frac{P_i}{A} + \frac{P_i e}{S_b} - \frac{M_g}{S_b}$$

		at midspan	at endspan	
Top stress at top fiber of beam	$f_t =$	-0.017 ksi	-0.017 ksi	OK
Bottom stress at bottom fiber of the beam	$f_b =$	2.906 ksi	2.906 ksi	OK

#### STRESSES AT HARP POINT

Bending moment due to beam weight at 0.3L	$M_g =$	1188.0 ft-kips		
Top stress at top fiber of beam	$f_t =$	0.173 ksi	0.169 ksi	OK
Bottom stress at bottom fiber of the beam	$f_b =$	2.736 ksi	2.621 ksi	OK

#### STRESSES AT MIDSPAN

Bending moment due to beam weight at 0.5L	$M_g =$	1414.3 ft-kips		
Top stress at top fiber of beam	$f_t =$	0.320 ksi	0.345 ksi	OK
Bottom stress at bottom fiber of the beam	$f_b =$	2.554 ksi	2.438 ksi	OK

### HOLD-DOWN FORCES

assume stress in strand before losses =  $0.8f_u$

layer 1	=	227.4 ksi
layer 2	=	227.4 ksi
layer 3	=	227.4 ksi
layer 4	=	227.4 ksi
layer 5	=	227.4 ksi
layer 6	=	227.4 ksi
layer 7	=	227.4 ksi
layer 8	=	227.4 ksi
layer 9	=	227.4 ksi
layer 10	=	227.4 ksi
layer 11	=	227.4 ksi
layer 12	=	227.4 ksi
layer 13	=	227.4 ksi
layer 14	=	227.4 ksi

prestress force per strand before any losses:

layer 1	=	19.3 kips
layer 2	=	19.3 kips
layer 3	=	19.3 kips
layer 4	=	19.3 kips
layer 5	=	19.3 kips
layer 6	=	19.3 kips
layer 7	=	19.3 kips
layer 8	=	19.3 kips
layer 9	=	19.3 kips
layer 10	=	19.3 kips
layer 11	=	19.3 kips
layer 12	=	19.3 kips
layer 13	=	19.3 kips
layer 14	=	19.3 kips
Harp Angle	$\psi$ =	7.2 °

Hold-down force/strand

layer 1	=	2.5 kips/strand
layer 2	=	2.5 kips/strand
layer 3	=	2.5 kips/strand
layer 4	=	2.5 kips/strand
layer 5	=	2.5 kips/strand
layer 6	=	2.5 kips/strand
layer 7	=	2.5 kips/strand
layer 8	=	2.5 kips/strand
layer 9	=	2.5 kips/strand
layer 10	=	2.5 kips/strand
layer 11	=	2.5 kips/strand
layer 12	=	2.5 kips/strand
layer 13	=	2.5 kips/strand
layer 14	=	2.5 kips/strand
Total hold-down force	=	30.45 kips

### Stresses at Service Loads

#### STRESS LIMITS FOR CONCRETE

##### Compression:

Due to permanent loads for load combination Service I

for the precast beam	=	3.150 ksi
for deck	=	1.274 ksi

Due to permanent and transient loads for load combination Service I

for the precast beam	=	4.200 ksi
for deck	=	1.698 ksi

##### Tension:

Load Combination Service III

for the precast beam	=	-0.016 ksi
----------------------	---	------------

STRESSES AT MIDSPAN			
Compression stresses at top fiber of beam		at midspan	at endspan
$f_s = \frac{F_{ps}}{A} - \frac{F_{ps}e}{S_t} + \frac{(M_D + M_L)}{S_t} + \frac{(M_{L2} + M_L)}{S_{L2}}$			
Due to permanent loads	$f_{ig} =$	2.110 ksi	2.108 ksi
$f_{L2} = \frac{F_{ps}}{A} - \frac{F_{ps}e}{S_t} + \frac{(M_D + M_L)}{S_t} + \frac{(M_{L2} + M_L)}{S_{L2}} + \frac{(M_{L+1})}{S_{L+1}}$			
Due to permanent loads and transient loads	$f_{ig} =$	2.574 ksi	2.572 ksi
Compression stresses at top fiber of deck		at midspan	at endspan
$f_{tr} = \frac{(M_{L2} + M_L)}{S_{tr}}$			
Due to permanent loads	$f_{ic} =$	0.040 ksi	0.040 ksi
$f_{tr} = \frac{(M_{L2} + M_L + M_{L+1})}{S_{tr}}$			
Due to permanent loads and transient loads	$f_{ic} =$	0.459 ksi	0.459 ksi
Tension stresses at top fiber of deck		at midspan	at endspan
$f_{tr} = \frac{P_{pe}}{A} + \frac{F_{pe}e}{S_b} - \frac{(M_D + M_L)}{S_b} - \frac{(M_{L2}   M_L   0.8 * M_{L+1})}{S_{L2}}$			
Load Combination Service III	$f_b =$	-0.812 ksi	-0.801 ksi

OK

OK

OK

OK

OK

**Strength Limit State**

POSITIVE MOMENT SECTION		
$M_u = 1.25DC + 1.5DW + 1.75(LL + IM)$	$M_u =$	8381.5 ft-kips
effective length factor for compression members		
layer 1	k =	0.27
layer 2	k =	0.27
layer 3	k =	0.27
layer 4	k =	0.27
layer 5	k =	0.27
layer 6	k =	0.27
layer 7	k =	0.27
layer 8	k =	0.27
layer 9	k =	0.27
layer 10	k =	0.27
layer 11	k =	0.27
layer 12	k =	0.27
layer 13	k =	0.27
layer 14	k =	0.27
	c =	6.5 ft-kips
average stress in prestressing steel		
layer 1	$f_{ps} =$	277.5 ksi
layer 2	$f_{ps} =$	277.5 ksi
layer 3	$f_{ps} =$	277.5 ksi
layer 4	$f_{ps} =$	277.5 ksi
layer 5	$f_{ps} =$	277.5 ksi
layer 6	$f_{ps} =$	277.5 ksi
layer 7	$f_{ps} =$	277.5 ksi
layer 8	$f_{ps} =$	277.5 ksi
layer 9	$f_{ps} =$	277.5 ksi
layer 10	$f_{ps} =$	277.5 ksi
layer 11	$f_{ps} =$	277.5 ksi
layer 12	$f_{ps} =$	277.5 ksi
layer 13	$f_{ps} =$	277.5 ksi
layer 14	$f_{ps} =$	277.5 ksi
nominal flexure resistance		
	a =	5.50 in
$M_r = \Phi M_n, \Phi = 1.00$	$\Phi M_n =$	9033.5 ft-kips
NEGATIVE MOMENT SECTION		
$M_u = 1.25DC + 1.5DW + 1.75(LL + IM)$	$M_u =$	-4837.2 ft-kips
	a =	0.18 in
	$\Phi M_n =$	4151.8 ft-kips

OK

NOT OK

### Shear Design

CRITICAL SECTION AT 0.59		
$V_u = 1.25DC + 1.5DW + 1.75(LL+IM)$	$V_u =$	405.0 kips
$M_u = 1.25DC + 1.5DW + 1.75(LL+IM)$	$M_u =$	-2684.4 ft-kips
or		
$V_u = 1.25DC + 1.5DW + 1.75(LL+IM)$	$V_u =$	364.8 kips
$M_u = 1.25DC + 1.5DW + 1.75(LL+IM)$	$M_u =$	-2877.0 ft-kips
max shear	$V_u =$	405.0 kips
max moment	$M_u =$	2877.0 ft-kips
Shear depth	$d_v =$	73.19 in
Applied factored normal force at the section	$N_u =$	0
Angle of diagonal compressive stresses	$\theta =$	36.00 °

### STRAIN IN FLEXURAL TENSION REINFORCEMENT

$$\epsilon_s = \frac{\frac{M_u}{d_v} + 0.5M_u + 0.5N_u \cot \theta - A_{ps}f_{ps}}{E_s A_s + E_p A_{ps}} \leq 0.002$$

	at midspan	at endspan
resultant compressive stress at centroid	$f_{pc} =$ 0.938 ksi	0.940 ksi
effective stress in prestressing strand after all losses		
layer 1	$f_{po} =$ 176.8 ksi	177.4 ksi
layer 2	$f_{po} =$ 176.8 ksi	177.4 ksi
layer 3	$f_{po} =$ 176.8 ksi	177.4 ksi
layer 4	$f_{po} =$ 176.8 ksi	177.4 ksi
layer 5	$f_{po} =$ 176.8 ksi	
layer 6	$f_{po} =$ 176.8 ksi	
layer 7	$f_{po} =$ 176.8 ksi	
layer 8	$f_{po} =$ 176.8 ksi	
layer 9	$f_{po} =$	177.4 ksi
layer 10	$f_{po} =$	177.4 ksi
layer 11	$f_{po} =$	177.4 ksi
layer 12	$f_{po} =$	177.4 ksi
layer 13	$f_{po} =$	177.4 ksi
layer 14	$f_{po} =$	177.4 ksi

strain in flexural tension

	at midspan	at endspan
layer 1	$\epsilon_x =$ 0.002000	0.002000
layer 2	$\epsilon_x =$ 0.002000	0.002000
layer 3	$\epsilon_x =$ 0.002000	0.002000
layer 4	$\epsilon_x =$ 0.002000	0.002000
layer 5	$\epsilon_x =$ 0.002000	
layer 6	$\epsilon_x =$ 0.002000	
layer 7	$\epsilon_x =$ 0.002000	
layer 8	$\epsilon_x =$ 0.002000	
layer 9	$\epsilon_x =$	0.002000
layer 10	$\epsilon_x =$	0.002000
layer 11	$\epsilon_x =$	0.002000
layer 12	$\epsilon_x =$	0.002000
layer 13	$\epsilon_x =$	0.002000
layer 14	$\epsilon_x =$	0.002000

### Deflection and Camber

	at midspan	at endspan
Deflection due to Prestressing Force at Transfer	$\Delta_p =$ 3.27 in	0.62 in
Deflection due to Beam Self-Weight at Transfer	$\Delta_{q1} =$ -1.49 in	
Deflection due to Beam Self-Weight at Erection	$\Delta_{q2} =$ -1.44 in	
Deflection due to Haunch and Deck	$\Delta_3 =$ -1.95 in	
Deflection due to total self weight	$\Delta_{sw} =$ -0.11 in	
Total Deflection at transfer	$\Delta =$ 1.79 in	-0.86 in
Total Deflection at erection	$\Delta =$ 3.24 in	-1.53 in

### Deck Deflection (assuming 12" beam)

Deflection due to Deck Self-Weight	$\Delta_q =$ -1.2857 in
Live load deflection limit = span/800	= 0.18 in
Deflection due to live load and impact	$\Delta_L =$ -0.70 in

OK

**Parametric Design: US Route 7 Case Study**  
**Beam Design: 1/2" Strand**  
**Fire Exposure Status: Undamaged**

(PCI Bridge Design Manual Section 9.6)



**Material Properties**

CAST-IN-PLACE SLAB		
Actual Thickness	$t_{as} =$	8.0 in
Wearing Surface	$=$	0.5 in
Structural thickness = Actual - Wearing Surface	$t_s =$	7.5 in
Compressive Strength	$f'_c =$	4.00 ksi
Unit Weight	$w_c =$	150.0 pcf
Stress factor of compression block	$\beta_1 =$	0.85

BEAMS: AASHTO-PCI, BT-72 BULB-TEE		
Strength at release	$f'_{ci} =$	5.5 ksi
Strength at 28 days	$f'_c =$	7 ksi
Unit Weight	$w_c =$	150.0 pcf
Overall Beam Length:		
@ end spans	$L =$	110 ft
@ center span	$L =$	119 ft
Design Spans:		
Non-composite beam @ end spans	$L =$	109 ft
Non-composite beam @ center span	$L =$	118 ft
Composite beam @ end spans	$L =$	110 ft
Composite beam @ center span	$L =$	120 ft
Beam Spacing	$S =$	12 ft



**PRESTRESSING STRANDS**

Diameter of single strand	d =	0.5 in
Area of single strand	A =	0.153 in <sup>2</sup>

Temperature of Layer

layer 1 (bottom)	T =	68.00 °F
layer 2	T =	68.00 °F
layer 3	T =	68.00 °F
layer 4	T =	68.00 °F
layer 5	T =	68.00 °F
layer 6	T =	68.00 °F
layer 7	T =	68.00 °F
layer 8	T =	68.00 °F
layer 9	T =	68.00 °F
layer 10	T =	68.00 °F
layer 11	T =	68.00 °F
layer 12	T =	68.00 °F
layer 13	T =	68.00 °F
layer 14	T =	68.00 °F

Ultimate Strength  
initial = 277 ksi

layer 1 (bottom)	$f_{pu}$ =	277 ksi
layer 2	$f_{pu}$ =	277 ksi
layer 3	$f_{pu}$ =	277 ksi
layer 4	$f_{pu}$ =	277 ksi
layer 5	$f_{pu}$ =	277 ksi
layer 6	$f_{pu}$ =	277 ksi
layer 7	$f_{pu}$ =	277 ksi
layer 8	$f_{pu}$ =	277 ksi
layer 9	$f_{pu}$ =	277 ksi
layer 10	$f_{pu}$ =	277 ksi
layer 11	$f_{pu}$ =	277 ksi
layer 12	$f_{pu}$ =	277 ksi
layer 13	$f_{pu}$ =	277 ksi
layer 14	$f_{pu}$ =	277 ksi

Yield Strength  
initial = 250 ksi

layer 1 (bottom)	$f_{py}$ =	250 ksi
layer 2	$f_{py}$ =	250 ksi
layer 3	$f_{py}$ =	250 ksi
layer 4	$f_{py}$ =	250 ksi
layer 5	$f_{py}$ =	250 ksi
layer 6	$f_{py}$ =	250 ksi
layer 7	$f_{py}$ =	250 ksi
layer 8	$f_{py}$ =	250 ksi
layer 9	$f_{py}$ =	250 ksi
layer 10	$f_{py}$ =	250 ksi
layer 11	$f_{py}$ =	250 ksi
layer 12	$f_{py}$ =	250 ksi
layer 13	$f_{py}$ =	250 ksi
layer 14	$f_{py}$ =	250 ksi

**Stress Limits:**  
before transfer  $\leq 0.75f_{pu}$  (initial = 207.6)

layer 1 (bottom)	$f_{pi}$ =	207.6 ksi
layer 2	$f_{pi}$ =	207.6 ksi
layer 3	$f_{pi}$ =	207.6 ksi
layer 4	$f_{pi}$ =	207.6 ksi
layer 5	$f_{pi}$ =	207.6 ksi
layer 6	$f_{pi}$ =	207.6 ksi
layer 7	$f_{pi}$ =	207.6 ksi
layer 8	$f_{pi}$ =	207.6 ksi
layer 9	$f_{pi}$ =	207.6 ksi
layer 10	$f_{pi}$ =	207.6 ksi
layer 11	$f_{pi}$ =	207.6 ksi
layer 12	$f_{pi}$ =	207.6 ksi
layer 13	$f_{pi}$ =	207.6 ksi
layer 14	$f_{pi}$ =	207.6 ksi

at service limit state (after all losses)  $\leq 0.80f_{py}$  (initial = 199.7)

layer 1 (bottom)	$f_{ps} =$	199.7 ksi
layer 2	$f_{ps} =$	199.7 ksi
layer 3	$f_{ps} =$	199.7 ksi
layer 4	$f_{ps} =$	199.7 ksi
layer 5	$f_{ps} =$	199.7 ksi
layer 6	$f_{ps} =$	199.7 ksi
layer 7	$f_{ps} =$	199.7 ksi
layer 8	$f_{ps} =$	199.7 ksi
layer 9	$f_{ps} =$	199.7 ksi
layer 10	$f_{ps} =$	199.7 ksi
layer 11	$f_{ps} =$	199.7 ksi
layer 12	$f_{ps} =$	199.7 ksi
layer 13	$f_{ps} =$	199.7 ksi
layer 14	$f_{ps} =$	199.7 ksi

Modulus of Elasticity

initial = 25982 ksi

layer 1 (bottom)	E =	25982.0 ksi
layer 2	E =	25982.0 ksi
layer 3	E =	25982.0 ksi
layer 4	E =	25982.0 ksi
layer 5	E =	25982.0 ksi
layer 6	E =	25982.0 ksi
layer 7	E =	25982.0 ksi
layer 8	E =	25982.0 ksi
layer 9	E =	25982.0 ksi
layer 10	E =	25982.0 ksi
layer 11	E =	25982.0 ksi
layer 12	E =	25982.0 ksi
layer 13	E =	25982.0 ksi
layer 14	E =	25982.0 ksi

### MILD STEEL REINFORCING BARS

Yield Strength

Layer 1 (Bottom)	$f_y =$	60.0 ksi	68.00 °F
Layer 2 (Top)	$f_y =$	60.0 ksi	68.00 °F

Modulus of Elasticity

E =	29000.0 ksi
-----	-------------

Layer 1 (Bottom)

Area of steel at midspan (effective flange)	$A_{sm} =$	2.79 in <sup>2</sup>
Area of steel at endsan (effective flange)	$A_{se} =$	2.48 in <sup>2</sup>
Area of temperature and shrinkage steel (12" width)	$A_s =$	0.31 in <sup>2</sup>

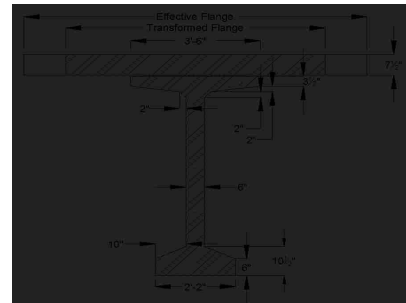
Layer 2 (Top)

Area of steel at midspan (effective flange)	$A_{sm} =$	12.6 in <sup>2</sup>
Area of steel at endsan (effective flange)	$A_{se} =$	12.4 in <sup>2</sup>
Area of temperature and shrinkage steel (12" width)	$A_s =$	0.2 in <sup>2</sup>

### Cross-sectional Properties

#### NON-COMPOSITE BEAM

Area of cross-section of beam	A =	767.0 in <sup>2</sup>
Overall depth of beam	H =	72.0 in
Moment of Inertia	I =	539,947 in <sup>4</sup>
Distance from centroid to extreme bottom fiber	$y_b =$	36.6 in
Distance from centroid to extreme top fiber	$y_t =$	35.4 in
Section modulus for the extreme bottom fiber	$S_b =$	14915.0 in <sup>3</sup>
Section modulus for the extreme top fiber	$S_t =$	15421.0 in <sup>3</sup>
Weight	$W_t =$	799.0 plf
Modulus of Elasticity = $33000 \cdot (W_c^{1.5}) \cdot (\sqrt{f_c})$		
cast-in-place concrete deck	$E_{cs} =$	3834 ksi
precast beam at release	$E_{ci} =$	4496 ksi
precast beam at service loads	$E_c =$	5072 ksi





### COMPOSITE BEAM AT MIDSPAN

Effective Flange Width	$b_f =$	111.0 in	*min of three criteria
Modular Ratio = $E_{cs}/E_c$	$n =$	0.7559	
Transformed flange width	$=$	83.9 in	
Transformed flange area	$=$	629.3 in <sup>2</sup>	
Transformed haunch width	$=$	31.7 in	
Transformed haunch area	$=$	15.9 in <sup>2</sup>	
Deck-distance to top fiber	$y_t =$	3.75 in	

	Transformed Area	$y_b$	$Ay_b$	$A(y_{bc}-y_b)^2$	$I$	$I + A(y_{bc}-y_b)^2$
Beam	767.0 in <sup>2</sup>	36.60 in	28,072.2 in <sup>3</sup>	250,443 in <sup>4</sup>	539,947 in <sup>4</sup>	790,390 in <sup>4</sup>
Haunch	15.9 in <sup>2</sup>	72.25 in	1,146.9 in <sup>3</sup>	4,906 in <sup>4</sup>	0.33 in <sup>4</sup>	4,906 in <sup>4</sup>
Deck	629.3 in <sup>2</sup>	76.25 in	47,985.0 in <sup>3</sup>	293,069 in <sup>4</sup>	2,950 in <sup>4</sup>	296,019 in <sup>4</sup>
Total	1412.2 in <sup>2</sup>		77,204.1 in <sup>3</sup>			1,091,316 in <sup>4</sup>

Total area of Composite Section	$A_c =$	1412 in <sup>2</sup>
Overall Depth of the Composite Section	$h_c =$	80 in
Moment of Inertia	$I_c =$	1,091,316 in <sup>4</sup>
Distance from centroid to extreme <u>bottom</u> fiber of beam	$y_{bc} =$	54.67 in
Distance from centroid to extreme <u>top</u> fiber of beam	$y_{tg} =$	17.33 in
Distance from centroid to extreme <u>top</u> fiber of slab	$y_{tc} =$	25.33 in
Section modulus for the extreme <u>bottom</u> fiber of beam	$S_{bc} =$	19,961.9 in <sup>3</sup>
Section modulus for the extreme <u>top</u> fiber of beam	$S_{tg} =$	62,972.4 in <sup>3</sup>
Section modulus for the extreme <u>top</u> fiber slab	$S_{tc} =$	56,994.5 in <sup>3</sup>

### COMPOSITE BEAM AT ENDSPAN

Effective Flange Width	$b_f =$	106.6 in	*min of three criteria
Modular Ratio = $E_{cs}/E_c$	$n =$	0.7559	
Transformed flange width	$=$	80.6 in	
Transformed flange area	$=$	604.4 in <sup>2</sup>	
Transformed haunch width	$=$	31.7 in	
Transformed haunch area	$=$	15.9 in <sup>2</sup>	
Deck-distance to top fiber	$y_{td} =$	3.75 in	

	Transformed Area	$y_t$	$Ay_t$	$A(y_{bc}-y_t)^2$	$I$	$I + A(y_{tc}-y_t)^2$
Beam	767.0 in <sup>2</sup>	36.60 in	28,072.2 in <sup>3</sup>	273,455 in <sup>4</sup>	539,947 in <sup>4</sup>	813,402 in <sup>4</sup>
Haunch	15.9 in <sup>2</sup>	72.25 in	1,146.9 in <sup>3</sup>	5,660 in <sup>4</sup>	0.33 in <sup>4</sup>	5,660 in <sup>4</sup>
Deck	604.4 in <sup>2</sup>	76.25 in	46,082.8 in <sup>3</sup>	215,472 in <sup>4</sup>	2,833 in <sup>4</sup>	218,305 in <sup>4</sup>
Total	1387.2 in <sup>2</sup>		75,302.0 in <sup>3</sup>			1,037,366 in <sup>4</sup>

Total area of Composite Section	$A_c =$	1387 in <sup>2</sup>
Overall Depth of the Composite Section	$h_c =$	80 in
Moment of Inertia	$I_c =$	1,037,366 in <sup>4</sup>
Distance from centroid to extreme <u>bottom</u> fiber of beam	$y_{bc} =$	54.28 in
Distance from centroid to extreme <u>top</u> fiber of beam	$y_{tg} =$	17.72 in
Distance from centroid to extreme <u>top</u> fiber of slab	$y_{tc} =$	25.72 in
Section modulus for the extreme <u>bottom</u> fiber of beam	$S_{bc} =$	19,110.7 in <sup>3</sup>
Section modulus for the extreme <u>top</u> fiber of beam	$S_{tg} =$	58,548.3 in <sup>3</sup>
Section modulus for the extreme <u>top</u> fiber slab	$S_{tc} =$	40,336.0 in <sup>3</sup>

### Shear Forces and Bending Moments

#### DEAD LOADS

Beam self-weight	$w_{beam} =$	0.799 k/f
8 in. deck weight	$w_{deck} =$	1.200 k/f
1/2 in. haunch weight	$w_{haunch} =$	0.022 k/f

#### LRFD Specifications: Art. 4.6.2.2.1

Width of Deck Constant		OK
Number of beams is not less than four $N_b =$	4	OK
Roadway part of the overhang, $d_o \leq 3.0$ ft, $d_o =$	1.5	OK
Curvature in plans is less than $4^\circ =$	0	OK
Cross-section of the bridge is consistent with one of the cross sections given by LRFD specs		OK

Barrier and wearing surface loads are equally distributed among the 4 beams

Barrier Wt	$W_t =$	0.150 k/f
Dead load of future wearing surface	$DW =$	0.263 k/f

**LIVE LOADS**

Fire truck live load front load (Point A)	$P_{live} =$	48.0 kips
Fire truck live load back load (Point B)	$P_{live} =$	22.0 kips
distance between two loads		19.2 ft
distance from nearest edge to point A	$x_a =$	59.0 ft
distance from nearest edge to point B	$x_b =$	39.8 ft
LRFD Specifications: Art. 4.6.2.2.1		
Width of Deck Constant		OK
Number of beams is not less than four $N_b =$	4	OK
Beams are parallel and approximately of the same stiffness		OK
Roadway part of the overhang, $d_o \leq 3.0$ ft, $d_o =$	1.5	OK
Curvature in plans is less than $4^\circ =$	0	OK

Barrier and wearing surface loads are equally distributed among the 4 beams

Bridge Type-- "K" (LRFD Table 4.6.2.2.1-1)

Number of design lanes = w/12	=	3 lanes
-------------------------------	---	---------

**Distribution Factor for Bending Moment:**

Beams spacing	S =	12.0 ft
Depth of concrete slab	$t_s =$	7.5 in
Beam Span	L =	120.0 ft
Number of Beams	$N_b =$	4
Modular ratio between beam & deck materials	n =	1.3229
Longitudinal stiffness parameter	$K_g =$	2,309,429.79 in <sup>4</sup>

at center span:		
$DFM = 0.75 + \left(\frac{S}{9.5}\right)^{0.6} * \left(\frac{S}{L}\right)^{0.2} * \left(\frac{K_g}{12 * L * t_s^3}\right)^{0.1}$		
DFM =	0.905 lanes/beam	

0.905 Controls

one design lane loaded:		
$DFM = 0.75 + \left(\frac{S}{14}\right)^{0.4} * \left(\frac{S}{L}\right)^{0.2} * \left(\frac{K_g}{12 * L * t_s^3}\right)^{0.1}$		
DFM =	0.614 lanes/beam	

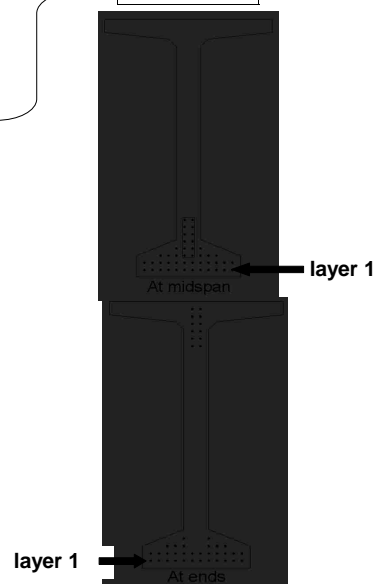
**Distribution Factor for Shear Force**

both end spans and center span:		
$DFV = 0.2 + \left(\frac{S}{12}\right) - \left(\frac{S}{35}\right)^2$		
DFV =	1.082 lanes/beam	

1.082 Controls

one design lane loaded:		
$DFV = 0.36 + \left(\frac{S}{25}\right)$		
DFV =	0.840 lanes/beam	

	At Midspan		At Ends	
from bottom	No. of	Distance from Bottom	No. of	Distance from Bottom
layer 1	12	2	12	2
layer 2	12	4	12	4
layer 3	8	6	6	6
layer 4	4	8	2	8
layer 5	2	10	-	-
layer 6	2	12	-	-
layer 7	2	14	-	-
layer 8	2	16	-	-
layer 9	-	-	2	60
layer 10	-	-	2	62
layer 11	-	-	2	64
layer 12	-	-	2	66
layer 13	-	-	2	68
layer 14	-	-	2	70
<b>Harped Strand Group (included in above totals)</b>				
layer 3	2	6		
layer 4	2	8		
layer 5	2	10		
layer 6	2	12		
layer 7	2	14		
layer 8	2	16		



distance from the center of gravity of strands to the bottom fiber of the beam = 7% of the beam depth  
strand eccentricity at midspan =  $(y_t - y_{bs})$

$y_{bs} =$	5.82 in
$e_c =$	30.78 in

### Prestress Losses

#### ELASTIC SHORTENING

assumed loss	=	9.00%
Force per strand at transfer		
layer 1	=	28.9 kips
layer 2	=	28.9 kips
layer 3	=	28.9 kips
layer 4	=	28.9 kips
layer 5	=	28.9 kips
layer 6	=	28.9 kips
layer 7	=	28.9 kips
layer 8	=	28.9 kips
layer 9	=	28.9 kips
layer 10	=	28.9 kips
layer 11	=	28.9 kips
layer 12	=	28.9 kips
layer 13	=	28.9 kips
layer 14	=	28.9 kips

Total prestressing force at release	$P_i =$	at midspan 1271.6 kips	at endspan 1271.6 kips
	Sum of concrete stresses at the center of gravity of prestressing tendons due to prestressing force at transfer and the self-weight of the member at sections of maximum moment $f_{cgp} =$	2.938 ksi	2.938 ksi
Loss due to shortening		at midspan	at endspan
	layer 1	$\Delta f_{pES} =$ 17.0 ksi	17.0 ksi
	layer 2	$\Delta f_{pES} =$ 17.0 ksi	17.0 ksi
	layer 3	$\Delta f_{pES} =$ 17.0 ksi	17.0 ksi
	layer 4	$\Delta f_{pES} =$ 17.0 ksi	17.0 ksi
	layer 5	$\Delta f_{pES} =$ 17.0 ksi	
	layer 6	$\Delta f_{pES} =$ 17.0 ksi	
	layer 7	$\Delta f_{pES} =$ 17.0 ksi	
	layer 8	$\Delta f_{pES} =$ 17.0 ksi	
	layer 9	$\Delta f_{pES} =$	17.0 ksi
	layer 10	$\Delta f_{pES} =$	17.0 ksi
	layer 11	$\Delta f_{pES} =$	17.0 ksi
	layer 12	$\Delta f_{pES} =$	17.0 ksi
	layer 13	$\Delta f_{pES} =$	17.0 ksi
	layer 14	$\Delta f_{pES} =$	17.0 ksi

#### SHRINKAGE

Shrinkage = $(17 - 0.15 \cdot \text{Relative Humidity})$	$\Delta f_{PSR} =$	6.5 ksi	← assume relative humidity = 70%
--	--------------------	---------	----------------------------------

#### CREEP OF CONCRETE

Change of stresses at center of gravity of prestressing due to permanent loads except the loads acting at time of applying prestressing force, calculated at the same section as $f_{cgp}$	$\Delta f_{cgp} =$	1.563 ksi	
	loss due to creep	$\Delta f_{PCR} =$	at midspan 24.3 ksi      at endspan 24.3 ksi

**RELAXATION OF PRESTRESSING STRANDS**

loss due to relaxation after transfer		at midspan	at endspan
layer 1	$\Delta f_{pR2} =$	2.1 ksi	2.1 ksi
layer 2	$\Delta f_{pR2} =$	2.1 ksi	2.1 ksi
layer 3	$\Delta f_{pR2} =$	2.1 ksi	2.1 ksi
layer 4	$\Delta f_{pR2} =$	2.1 ksi	2.1 ksi
layer 5	$\Delta f_{pR2} =$	2.1 ksi	
layer 6	$\Delta f_{pR2} =$	2.1 ksi	
layer 7	$\Delta f_{pR2} =$	2.1 ksi	
layer 8	$\Delta f_{pR2} =$	2.1 ksi	
layer 9	$\Delta f_{pR2} =$		2.1 ksi
layer 10	$\Delta f_{pR2} =$		2.1 ksi
layer 11	$\Delta f_{pR2} =$		2.1 ksi
layer 12	$\Delta f_{pR2} =$		2.1 ksi
layer 13	$\Delta f_{pR2} =$		2.1 ksi
layer 14	$\Delta f_{pR2} =$		2.1 ksi

**TOTAL LOSSES AT TRANSFER**

total loss  $\Delta f_{pES} = \Delta f_{pi}$

stress in tendons after transfer  $f_{pt} = f_{pi} - \Delta f_{pi}$

		at midspan	at endspan
layer 1	$f_{pt} =$	190.6 ksi	190.6 ksi
layer 2	$f_{pt} =$	190.6 ksi	190.6 ksi
layer 3	$f_{pt} =$	190.6 ksi	190.6 ksi
layer 4	$f_{pt} =$	190.6 ksi	190.6 ksi
layer 5	$f_{pt} =$	190.6 ksi	
layer 6	$f_{pt} =$	190.6 ksi	
layer 7	$f_{pt} =$	190.6 ksi	
layer 8	$f_{pt} =$	190.6 ksi	
layer 9	$f_{pt} =$		190.6 ksi
layer 10	$f_{pt} =$		190.6 ksi
layer 11	$f_{pt} =$		190.6 ksi
layer 12	$f_{pt} =$		190.6 ksi
layer 13	$f_{pt} =$		190.6 ksi
layer 14	$f_{pt} =$		190.6 ksi

force per strand =  $f_{pt} \times \text{strand area}$

		at midspan	at endspan
layer 1	=	29.2 kips	29.2 kips
layer 2	=	29.2 kips	29.2 kips
layer 3	=	29.2 kips	29.2 kips
layer 4	=	29.2 kips	29.2 kips
layer 5	=	29.2 kips	
layer 6	=	29.2 kips	
layer 7	=	29.2 kips	
layer 8	=	29.2 kips	
layer 9	=		29.2 kips
layer 10	=		29.2 kips
layer 11	=		29.2 kips
layer 12	=		29.2 kips
layer 13	=		29.2 kips
layer 14	=		29.2 kips
Total prestressing force after transfer	$P_1 =$	1284.8 kips	1284.8 kips

Initial loss =  $(\Delta f_{pi}) / (f_{pi})$

		at midspan	at endspan
layer 1	% =	8.2%	8.2%
layer 2	% =	8.2%	8.2%
layer 3	% =	8.2%	8.2%
layer 4	% =	8.2%	8.2%
layer 5	% =	8.2%	
layer 6	% =	8.2%	
layer 7	% =	8.2%	
layer 8	% =	8.2%	
layer 9	% =		8.2%
layer 10	% =		8.2%
layer 11	% =		8.2%
layer 12	% =		8.2%
layer 13	% =		8.2%
layer 14	% =		8.2%

OK  
OK  
OK  
OK  
OK  
OK  
OK  
OK  
OK  
OK  
OK  
OK  
OK  
OK

**TOTAL LOSSES AT SERVICE LOADS**

Total Losses		at midspan	at endspan
layer 1	$\Delta f_{pT} =$	49.9 ksi	49.9 ksi
layer 2	$\Delta f_{pT} =$	49.9 ksi	49.9 ksi
layer 3	$\Delta f_{pT} =$	49.9 ksi	49.9 ksi
layer 4	$\Delta f_{pT} =$	49.9 ksi	49.9 ksi
layer 5	$\Delta f_{pT} =$	49.9 ksi	
layer 6	$\Delta f_{pT} =$	49.9 ksi	
layer 7	$\Delta f_{pT} =$	49.9 ksi	
layer 8	$\Delta f_{pT} =$	49.9 ksi	
layer 9	$\Delta f_{pT} =$		49.9 ksi
layer 10	$\Delta f_{pT} =$		49.9 ksi
layer 11	$\Delta f_{pT} =$		49.9 ksi
layer 12	$\Delta f_{pT} =$		49.9 ksi
layer 13	$\Delta f_{pT} =$		49.9 ksi
layer 14	$\Delta f_{pT} =$		49.9 ksi

Stress in tendon after all losses =  $f_{pe} - \Delta f_{pT}$

		at midspan	at endspan
layer 1	$f_{pe} =$	157.7 ksi	157.7 ksi
layer 2	$f_{pe} =$	157.7 ksi	157.7 ksi
layer 3	$f_{pe} =$	157.7 ksi	157.7 ksi
layer 4	$f_{pe} =$	157.7 ksi	157.7 ksi
layer 5	$f_{pe} =$	157.7 ksi	
layer 6	$f_{pe} =$	157.7 ksi	
layer 7	$f_{pe} =$	157.7 ksi	
layer 8	$f_{pe} =$	157.7 ksi	
layer 9	$f_{pe} =$		157.7 ksi
layer 10	$f_{pe} =$		157.7 ksi
layer 11	$f_{pe} =$		157.7 ksi
layer 12	$f_{pe} =$		157.7 ksi
layer 13	$f_{pe} =$		157.7 ksi
layer 14	$f_{pe} =$		157.7 ksi

check prestressing stress limit at service limit state:  $f_{pe} \leq 0.8 \cdot f_{py}$

layer 1	=	199.7 ksi
layer 2	=	199.7 ksi
layer 3	=	199.7 ksi
layer 4	=	199.7 ksi
layer 5	=	199.7 ksi
layer 6	=	199.7 ksi
layer 7	=	199.7 ksi
layer 8	=	199.7 ksi
layer 9	=	199.7 ksi
layer 10	=	199.7 ksi
layer 11	=	199.7 ksi
layer 12	=	199.7 ksi
layer 13	=	199.7 ksi
layer 14	=	199.7 ksi

OK  
OK  
OK  
OK  
OK  
OK  
OK  
OK  
OK  
OK  
OK  
OK  
OK  
OK

force per strand =  $f_{pe} \cdot \text{strand area}$

		at midspan	at endspan
layer 1	=	24.1 kips	24.1 kips
layer 2	=	24.1 kips	24.1 kips
layer 3	=	24.1 kips	24.1 kips
layer 4	=	24.1 kips	24.1 kips
layer 5	=	24.1 kips	
layer 6	=	24.1 kips	
layer 7	=	24.1 kips	
layer 8	=	24.1 kips	
layer 9	=		24.1 kips
layer 10	=		24.1 kips
layer 11	=		24.1 kips
layer 12	=		24.1 kips
layer 13	=		24.1 kips
layer 14	=		24.1 kips

Total prestressing force after all losses		at midspan	at endspan
$P_{pe} =$		1061.6 kips	1061.6 kips

Final losses, % =  $(\Delta f_{pT})/f_{pi}$

layer 1	% =	24.0%	24.0%
layer 2	% =	24.0%	24.0%
layer 3	% =	24.0%	24.0%
layer 4	% =	24.0%	24.0%
layer 5	% =	24.0%	
layer 6	% =	24.0%	
layer 7	% =	24.0%	
layer 8	% =	24.0%	
layer 9	% =		24.0%
layer 10	% =		24.0%
layer 11	% =		24.0%
layer 12	% =		24.0%
layer 13	% =		24.0%
layer 14	% =		24.0%
Average final losses, %	% =	24.0%	24.0%

**Stresses at Transfer**

**STRESS LIMITS FOR CONCRETE**

Compression = $0.6f_{ci}$	$f_{ci}$ =	3.300 ksi
Tension		
without bonded reinforcement = $-0.0948\sqrt{f_{ci}} \leq -0.2$	=	-0.200 ksi
with bonded auxiliary reinforcement = $-0.22\sqrt{f_{ci}}$	=	-0.016 ksi

**STRESSES AT TRANSFER LENGTH SECTION**

Transfer Length = $60 \times (\text{strand diameter})$	=	2.5 ft	} Calcs for eccentricity (see 9.6.7.2)
Bending moment at transfer length	$M_g$ =	116.4 ft-kips	
center of 12 strands to top fiber of beam at the end	=	7.00 in	
center of 12 strands to bottom fiber of beam at the harp point	=	11.00 in	
center of 12 strands and top fiber of beam at transfer length	=	10.78 in	
center of gravity of 32 strands and bottom fiber of beam	=	3.88 in	
center of gravity of all strands and the bottom fiber of beam at transfer length	=	19.51 in	
center of gravity of all strands and the bottom fiber of beam at the end	=	20.55 in	
Eccentricity of the strand group at transfer length:	$e_n$ =	17.09 in	
Eccentricity at end of beam:	$e$ =	16.05 in	

$f_t = \frac{P_i}{A} - \frac{P_i e}{S_t} + \frac{M_g}{S_t}$	$f_b = \frac{P_i}{A} + \frac{P_i e}{S_b} - \frac{M_g}{S_b}$		
		<b>at midspan</b>	<b>at endspan</b>
Top stress at top fiber of beam	$f_t$ =	0.342 ksi	0.342 ksi
Bottom stress at bottom fiber of the beam	$f_b$ =	3.021 ksi	3.021 ksi

OK  
OK

**STRESSES AT HARP POINT**

Bending moment due to beam weight at 0.3L	$M_g$ =	1184.2 ft-kips	
Top stress at top fiber of beam	$f_t$ =	0.032 ksi	0.032 ksi
Bottom stress at bottom fiber of the beam	$f_b$ =	3.300 ksi	3.300 ksi

OK  
OK

**STRESSES AT MIDSPAN**

Bending moment due to beam weight at 0.5L	$M_g$ =	1414.3 ft-kips	
Top stress at top fiber of beam	$f_t$ =	0.220 ksi	0.211 ksi
Bottom stress at bottom fiber of the beam	$f_b$ =	3.144 ksi	3.189 ksi

OK  
OK

**HOLD-DOWN FORCES**

assume stress in strand before losses =  $0.8f_u$

layer 1	=	221.4 ksi
layer 2	=	221.4 ksi
layer 3	=	221.4 ksi
layer 4	=	221.4 ksi
layer 5	=	221.4 ksi
layer 6	=	221.4 ksi
layer 7	=	221.4 ksi
layer 8	=	221.4 ksi
layer 9	=	221.4 ksi
layer 10	=	221.4 ksi
layer 11	=	221.4 ksi
layer 12	=	221.4 ksi
layer 13	=	221.4 ksi
layer 14	=	221.4 ksi

prestress force per strand before any losses:

layer 1	=	33.9 kips
layer 2	=	33.9 kips
layer 3	=	33.9 kips
layer 4	=	33.9 kips
layer 5	=	33.9 kips
layer 6	=	33.9 kips
layer 7	=	33.9 kips
layer 8	=	33.9 kips
layer 9	=	33.9 kips
layer 10	=	33.9 kips
layer 11	=	33.9 kips
layer 12	=	33.9 kips
layer 13	=	33.9 kips
layer 14	=	33.9 kips
Harp Angle	$\psi =$	7.2 °

Hold-down force/strand

layer 1	=	4.4 kips/strand
layer 2	=	4.4 kips/strand
layer 3	=	4.4 kips/strand
layer 4	=	4.4 kips/strand
layer 5	=	4.4 kips/strand
layer 6	=	4.4 kips/strand
layer 7	=	4.4 kips/strand
layer 8	=	4.4 kips/strand
layer 9	=	4.4 kips/strand
layer 10	=	4.4 kips/strand
layer 11	=	4.4 kips/strand
layer 12	=	4.4 kips/strand
layer 13	=	4.4 kips/strand
layer 14	=	4.4 kips/strand
Total hold-down force	=	53.39 kips

### Stresses at Service Loads

#### STRESS LIMITS FOR CONCRETE

Compression:

Due to permanent loads for load combination Service I

for the precast beam	=	3.150 ksi
for deck	=	1.800 ksi

Due to permanent and transient loads for load combination Service I

for the precast beam	=	4.200 ksi
for deck	=	2.400 ksi

Tension:

Load Combination Service III

for the precast beam	=	-0.016 ksi
----------------------	---	------------

#### STRESSES AT MIDSPAN

Compression stresses at top fiber of beam	at midspan	at endspan	
$f_t = \frac{P_{pe}}{A} - \frac{P_{pe}e}{S_x} + \frac{(M_D + M_{L1})}{S_x} - \frac{(M_{ws} + M_D)}{S_{ly}}$			
Due to permanent loads	$f_{t1} =$	2.041 ksi	2.041 ksi
$f_{t2} = \frac{P_{pe}}{A} - \frac{P_{pe}e}{S_x} + \frac{(M_D + M_{L1})}{S_x} + \frac{(M_{ws} + M_D)}{S_{ly}} + \frac{(M_{LL1})}{S_{ly}}$			
Due to permanent loads and transient loads	$f_{t2} =$	2.444 ksi	2.444 ksi
OK			
Compression stresses at top fiber of deck	at midspan	at endspan	
$f_{tc} = \frac{(M_{ws} + M_D)}{S_{xt}}$			
Due to permanent loads	$f_{tc} =$	0.042 ksi	0.042 ksi
$f_{tc} = \frac{(M_{ws} + M_D + M_{LL1})}{S_{xt}}$			
Due to permanent loads and transient loads	$f_{tc} =$	0.488 ksi	0.488 ksi
OK			
Tension stresses at top fiber of deck	at midspan	at endspan	
$f_{tr} = \frac{P_{pe}}{A} + \frac{P_{pe}e}{S_y} - \frac{(M_D + M_{L1})}{S_y} - \frac{(M_{ws} + M_D + 0.8 * M_{LL1})}{S_{xt}}$			
Load Combination Service III	$f_{tr} =$	-0.393 ksi	-0.393 ksi
OK			

**Strength Limit State**

**POSITIVE MOMENT SECTION**

$M_u = 1.25DC+1.5DW+1.75(LL+IM)$	$M_u =$	8381.5 ft-kips
effective length factor for compression members		
layer 1	k =	0.28
layer 2	k =	0.28
layer 3	k =	0.28
layer 4	k =	0.28
layer 5	k =	0.28
layer 6	k =	0.28
layer 7	k =	0.28
layer 8	k =	0.28
layer 9	k =	0.28
layer 10	k =	0.28
layer 11	k =	0.28
layer 12	k =	0.28
layer 13	k =	0.28
layer 14	k =	0.28
	c =	5.7 ft-kips

average stress in prestressing steel

layer 1	$f_{ps} =$	270.9 ksi
layer 2	$f_{ps} =$	270.9 ksi
layer 3	$f_{ps} =$	270.9 ksi
layer 4	$f_{ps} =$	270.9 ksi
layer 5	$f_{ps} =$	270.9 ksi
layer 6	$f_{ps} =$	270.9 ksi
layer 7	$f_{ps} =$	270.9 ksi
layer 8	$f_{ps} =$	270.9 ksi
layer 9	$f_{ps} =$	270.9 ksi
layer 10	$f_{ps} =$	270.9 ksi
layer 11	$f_{ps} =$	270.9 ksi
layer 12	$f_{ps} =$	270.9 ksi
layer 13	$f_{ps} =$	270.9 ksi
layer 14	$f_{ps} =$	270.9 ksi

nominal flexure resistance

	a =	4.85 in
$M_r = \Phi M_n, \Phi = 1.00$	$\Phi M_n =$	10906.2 ft-kips

OK

**NEGATIVE MOMENT SECTION**

$M_u = 1.25DC+1.5DW+1.75(LL+IM)$	$M_u =$	-4837.2 ft-kips
	a =	0.20 in
	$\Phi M_n =$	5099.1 ft-kips

OK

**Shear Design**

**CRITICAL SECTION AT 0.59**

$V_u = 1.25DC+1.5DW+1.75(LL+IM)$	$V_u =$	405.0 kips
$M_u = 1.25DC+1.5DW+1.75(LL+IM)$	$M_u =$	-2684.4 ft-kips
or		
$V_u = 1.25DC+1.5DW+1.75(LL+IM)$	$V_u =$	364.8 kips
$M_u = 1.25DC+1.5DW+1.75(LL+IM)$	$M_u =$	-2877.0 ft-kips
max shear	$V_u =$	405.0 kips
max moment	$M_u =$	2877.0 ft-kips
Shear depth	$d_v =$	73.19 in
Applied factored normal force at the section	$N_u =$	0
Angle of diagonal compressive stresses	$\theta =$	36.00 °



**STRAIN IN FLEXURAL TENSION REINFORCEMENT**

$$\epsilon_x = \frac{\frac{M}{d_v} + 0.5N_u + 0.5P_u \cot \theta - A_{ps}f_{po}}{E_s A_s + E_p A_{ps}} \leq 0.002$$

		at midspan	at endspan
resultant compressive stress at centroid	$f_{pc} =$	0.994 ksi	0.994 ksi
effective stress in prestressing strand after all losses			
layer 1	$f_{po} =$	162.8 ksi	162.8 ksi
layer 2	$f_{po} =$	162.8 ksi	162.8 ksi
layer 3	$f_{po} =$	162.8 ksi	162.8 ksi
layer 4	$f_{po} =$	162.8 ksi	162.8 ksi
layer 5	$f_{po} =$	162.8 ksi	
layer 6	$f_{po} =$	162.8 ksi	
layer 7	$f_{po} =$	162.8 ksi	
layer 8	$f_{po} =$	162.8 ksi	
layer 9	$f_{po} =$		162.8 ksi
layer 10	$f_{po} =$		162.8 ksi
layer 11	$f_{po} =$		162.8 ksi
layer 12	$f_{po} =$		162.8 ksi
layer 13	$f_{po} =$		162.8 ksi
layer 14	$f_{po} =$		162.8 ksi
strain in flexural tension		at midspan	at endspan
layer 1	$\epsilon_x =$	0.002000	0.002000
layer 2	$\epsilon_x =$	0.002000	0.002000
layer 3	$\epsilon_x =$	0.002000	0.002000
layer 4	$\epsilon_x =$	0.002000	0.002000
layer 5	$\epsilon_x =$	0.002000	
layer 6	$\epsilon_x =$	0.002000	
layer 7	$\epsilon_x =$	0.002000	
layer 8	$\epsilon_x =$	0.002000	
layer 9	$\epsilon_x =$		0.002000
layer 10	$\epsilon_x =$		0.002000
layer 11	$\epsilon_x =$		0.002000
layer 12	$\epsilon_x =$		0.002000
layer 13	$\epsilon_x =$		0.002000
layer 14	$\epsilon_x =$		0.002000

**Deflection and Camber**

		at midspan	at endspan
Deflection due to Prestressing Force at Transfer	$\Delta_p =$	3.97 in	3.97 in
Deflection due to Beam Self-Weight at Transfer	$\Delta_g =$	-1.49 in	
Deflection due to Beam Self-Weight at Erection	$\Delta_g =$	-1.44 in	
Deflection due to Haunch and Deck	$\Delta_g =$	-1.95 in	
Deflection due to total self weight	$\Delta_{sw} =$	0.59 in	
Total Deflection at transfer	$\Delta =$	2.48 in	2.48 in
Total Deflection at erection	$\Delta =$	4.49 in	4.49 in
Live load deflection limit = span/800	$=$	1.80 in	
Deflection due to live load and impact	$\Delta_L =$	-0.83 in	
Deflection due to fire truck	$\Delta_L =$	-0.7520 in	
Total Deflection after fire with fire truck	$\Delta =$	3.8033 in	

OK

OK

**Parametric Design: US Route 7 Case Study**  
**Beam Design: 1/2" Strand**  
**Fire Exposure Status: Damaged**

(PCI Bridge Design Manual Section 9.6)



**Material Properties**

CAST-IN-PLACE SLAB		
Actual Thickness	$t_{as} =$	8.0 in
Wearing Surface	$=$	0.5 in
Structural thickness = Actual - Wearing Surface	$t_s =$	7.5 in
Compressive Strength	$f_c =$	3.09 ksi
Unit Weight	$w_c =$	150.0 pcf
Stress factor of compression block	$\beta_1 =$	0.85

BEAMS: AASHTO-PCI, BT-72 BULB-TEE		
Strength at release	$f'_{ci} =$	5.5 ksi
Strength at 28 days	$f'_c =$	7 ksi
Unit Weight	$w_c =$	150.0 pcf
Overall Beam Length:		
@ end spans	$L =$	110 ft
@ center span	$L =$	119 ft
Design Spans:		
Non-composite beam @ end spans	$L =$	109 ft
Non-composite beam @ center span	$L =$	118 ft
Composite beam @ end spans	$L =$	110 ft
Composite beam @ center span	$L =$	120 ft
Beam Spacing	$S =$	12 ft



**PRESTRESSING STRANDS**

Diameter of single strand	d =	0.5 in
Area of single strand	A =	0.153 in <sup>2</sup>

Temperature of Layer	layer 1 (bottom)	T =	68.00 °F
	layer 2	T =	68.00 °F
	layer 3	T =	68.00 °F
	layer 4	T =	68.00 °F
	layer 5	T =	68.00 °F
	layer 6	T =	68.00 °F
	layer 7	T =	68.00 °F
	layer 8	T =	68.00 °F
	layer 9	T =	68.00 °F
	layer 10	T =	68.00 °F
	layer 11	T =	68.00 °F
	layer 12	T =	68.00 °F
	layer 13	T =	68.00 °F
	layer 14	T =	68.00 °F

Ultimate Strength initial = 277 ksi	layer 1 (bottom)	$f_{pu}$ =	277 ksi
	layer 2	$f_{pu}$ =	277 ksi
	layer 3	$f_{pu}$ =	277 ksi
	layer 4	$f_{pu}$ =	277 ksi
	layer 5	$f_{pu}$ =	277 ksi
	layer 6	$f_{pu}$ =	277 ksi
	layer 7	$f_{pu}$ =	277 ksi
	layer 8	$f_{pu}$ =	277 ksi
	layer 9	$f_{pu}$ =	277 ksi
	layer 10	$f_{pu}$ =	277 ksi
	layer 11	$f_{pu}$ =	277 ksi
	layer 12	$f_{pu}$ =	277 ksi
	layer 13	$f_{pu}$ =	277 ksi
	layer 14	$f_{pu}$ =	277 ksi

Yield Strength initial = 250 ksi	layer 1 (bottom)	$f_{py}$ =	250 ksi
	layer 2	$f_{py}$ =	250 ksi
	layer 3	$f_{py}$ =	250 ksi
	layer 4	$f_{py}$ =	250 ksi
	layer 5	$f_{py}$ =	250 ksi
	layer 6	$f_{py}$ =	250 ksi
	layer 7	$f_{py}$ =	250 ksi
	layer 8	$f_{py}$ =	250 ksi
	layer 9	$f_{py}$ =	250 ksi
	layer 10	$f_{py}$ =	250 ksi
	layer 11	$f_{py}$ =	250 ksi
	layer 12	$f_{py}$ =	250 ksi
	layer 13	$f_{py}$ =	250 ksi
	layer 14	$f_{py}$ =	250 ksi

Stress Limits: before transfer $\leq 0.75f_{pu}$ (initial = 207.6)	layer 1 (bottom)	$f_{pi}$ =	207.6 ksi
	layer 2	$f_{pi}$ =	207.6 ksi
	layer 3	$f_{pi}$ =	207.6 ksi
	layer 4	$f_{pi}$ =	207.6 ksi
	layer 5	$f_{pi}$ =	207.6 ksi
	layer 6	$f_{pi}$ =	207.6 ksi
	layer 7	$f_{pi}$ =	207.6 ksi
	layer 8	$f_{pi}$ =	207.6 ksi
	layer 9	$f_{pi}$ =	207.6 ksi
	layer 10	$f_{pi}$ =	207.6 ksi
	layer 11	$f_{pi}$ =	207.6 ksi
	layer 12	$f_{pi}$ =	207.6 ksi
	layer 13	$f_{pi}$ =	207.6 ksi
	layer 14	$f_{pi}$ =	207.6 ksi

at service limit state (after all losses)  $\leq 0.80f_{py}$  (initial = 199.7)

layer 1 (bottom)	$f_{pe} =$	199.7 ksi
layer 2	$f_{pe} =$	199.7 ksi
layer 3	$f_{pe} =$	199.7 ksi
layer 4	$f_{pe} =$	199.7 ksi
layer 5	$f_{pe} =$	199.7 ksi
layer 6	$f_{pe} =$	199.7 ksi
layer 7	$f_{pe} =$	199.7 ksi
layer 8	$f_{pe} =$	199.7 ksi
layer 9	$f_{pe} =$	199.7 ksi
layer 10	$f_{pe} =$	199.7 ksi
layer 11	$f_{pe} =$	199.7 ksi
layer 12	$f_{pe} =$	199.7 ksi
layer 13	$f_{pe} =$	199.7 ksi
layer 14	$f_{pe} =$	199.7 ksi

Modulus of Elasticity

initial = 25982 ksi

layer 1 (bottom)	E =	25982.0 ksi
layer 2	E =	25982.0 ksi
layer 3	E =	25982.0 ksi
layer 4	E =	25982.0 ksi
layer 5	E =	25982.0 ksi
layer 6	E =	25982.0 ksi
layer 7	E =	25982.0 ksi
layer 8	E =	25982.0 ksi
layer 9	E =	25982.0 ksi
layer 10	E =	25982.0 ksi
layer 11	E =	25982.0 ksi
layer 12	E =	25982.0 ksi
layer 13	E =	25982.0 ksi
layer 14	E =	25982.0 ksi

### MILD STEEL REINFORCING BARS

Yield Strength

Layer 1 (Bottom)	$f_y =$	60.0 ksi	68.00 °F
Layer 2 (Top)	$f_y =$	51.6 ksi	1193.00 °F

Modulus of Elasticity

E =	29000.0 ksi
-----	-------------

Layer 1 (Bottom)

Area of steel at midspan (effective flange)	$A_{sm} =$	2.79 in <sup>2</sup>
Area of steel at endspan (effective flange)	$A_{se} =$	2.48 in <sup>2</sup>
Area of temperature and shrinkage steel (12" width)	$A_s =$	0.31 in <sup>2</sup>

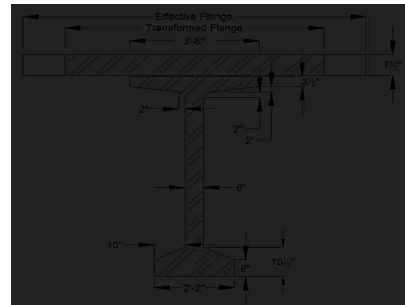
Layer 2 (Top)

Area of steel at midspan (effective flange)	$A_{sm} =$	12.6 in <sup>2</sup>
Area of steel at endspan (effective flange)	$A_{se} =$	12.4 in <sup>2</sup>
Area of temperature and shrinkage steel (12" width)	$A_s =$	0.2 in <sup>2</sup>

### Cross-sectional Properties

#### NON-COMPOSITE BEAM

Area of cross-section of beam	A =	767.0 in <sup>2</sup>
Overall depth of beam	H =	72.0 in
Moment of Inertia	I =	539,947 in <sup>4</sup>
Distance from centroid to extreme <u>bottom</u> fiber	$y_b =$	36.6 in
Distance from centroid to extreme <u>top</u> fiber	$y_t =$	35.4 in
Section modulus for the extreme <u>bottom</u> fiber	$S_b =$	14915.0 in <sup>3</sup>
Section modulus for the extreme <u>top</u> fiber	$S_t =$	15421.0 in <sup>3</sup>
Weight	$W_t =$	799.0 plf
Modulus of Elasticity = $33000 \cdot (W_c \cdot 1.5) \cdot (\sqrt{f_c})$		
cast-in-place concrete deck	$E_{cs} =$	3370 ksi
precast beam at release	$E_{ci} =$	4496 ksi
precast beam at service loads	$E_c =$	5072 ksi



### COMPOSITE BEAM AT MIDSPAN

Effective Flange Width	$b_f =$	111.0 in	*min of three criteria
Modular Ratio = $E_{cf}/E_c$	$n =$	0.6644	
Transformed flange width	$=$	73.7 in	
Transformed flange area	$=$	553.1 in <sup>2</sup>	
Transformed haunch width	$=$	27.9 in	
Transformed haunch area	$=$	14.0 in <sup>2</sup>	
Deck-distance to top fiber	$y_t =$	4.82 in	

	Transformed Area	$y_b$	$Ay_b$	$A(y_{bc}-y_b)^2$	$I$	$I + A(y_{bc}-y_b)^2$
Beam	767.0 in <sup>2</sup>	36.60 in	28,072.2 in <sup>3</sup>	205,498 in <sup>4</sup>	539,947 in <sup>4</sup>	745,445 in <sup>4</sup>
Haunch	14.0 in <sup>2</sup>	72.25 in	1,008.1 in <sup>3</sup>	5,187 in <sup>4</sup>	0.33 in <sup>4</sup>	5,188 in <sup>4</sup>
Deck	553.1 in <sup>2</sup>	75.18 in	41,583.1 in <sup>3</sup>	272,881 in <sup>4</sup>	1,499 in <sup>4</sup>	274,380 in <sup>4</sup>
Total	1334.1 in <sup>2</sup>		70,663.4 in <sup>3</sup>			1,025,013 in <sup>4</sup>

Total area of Composite Section	$A_c =$	1334 in <sup>2</sup>
Overall Depth of the Composite Section	$h_c =$	80 in
Moment of Inertia	$I_c =$	1,025,013 in <sup>4</sup>
Distance from centroid to extreme <u>bottom</u> fiber of beam	$y_{bc} =$	52.97 in
Distance from centroid to extreme <u>top</u> fiber of beam	$y_{tc} =$	19.03 in
Distance from centroid to extreme <u>top</u> fiber of slab	$y_{ts} =$	27.03 in
Section modulus for the extreme <u>bottom</u> fiber of beam	$S_{bc} =$	19,351.4 in <sup>3</sup>
Section modulus for the extreme <u>top</u> fiber of beam	$S_{tc} =$	53,858.5 in <sup>3</sup>
Section modulus for the extreme <u>top</u> fiber slab	$S_{ts} =$	57,072.6 in <sup>3</sup>

### COMPOSITE BEAM AT ENDSPAN

Effective Flange Width	$b_f =$	106.6 in	*min of three criteria
Modular Ratio = $E_{cf}/E_c$	$n =$	0.6644	
Transformed flange width	$=$	70.8 in	
Transformed flange area	$=$	531.2 in <sup>2</sup>	
Transformed haunch width	$=$	27.9 in	
Transformed haunch area	$=$	14.0 in <sup>2</sup>	
Deck-distance to top fiber	$y_{td} =$	4.56 in	

	Transformed Area	$y_t$	$Ay_t$	$A(y_{tc}-y_t)^2$	$I$	$I + A(y_{tc}-y_t)^2$
Beam	767.0 in <sup>2</sup>	36.60 in	28,072.2 in <sup>3</sup>	247,359 in <sup>4</sup>	539,947 in <sup>4</sup>	787,306 in <sup>4</sup>
Haunch	14.0 in <sup>2</sup>	72.25 in	1,008.1 in <sup>3</sup>	4,500 in <sup>4</sup>	0.29 in <sup>4</sup>	4,500 in <sup>4</sup>
Deck	531.2 in <sup>2</sup>	77.06 in	40,933.4 in <sup>3</sup>	171,309 in <sup>4</sup>	2,182 in <sup>4</sup>	173,491 in <sup>4</sup>
Total	1312.1 in <sup>2</sup>		70,013.7 in <sup>3</sup>			965,297 in <sup>4</sup>

Total area of Composite Section	$A_c =$	1312 in <sup>2</sup>
Overall Depth of the Composite Section	$h_c =$	80 in
Moment of Inertia	$I_c =$	965,297 in <sup>4</sup>
Distance from centroid to extreme <u>bottom</u> fiber of beam	$y_{bc} =$	53.36 in
Distance from centroid to extreme <u>top</u> fiber of beam	$y_{tc} =$	18.64 in
Distance from centroid to extreme <u>top</u> fiber of slab	$y_{ts} =$	26.64 in
Section modulus for the extreme <u>bottom</u> fiber of beam	$S_{bc} =$	18,090.8 in <sup>3</sup>
Section modulus for the extreme <u>top</u> fiber of beam	$S_{tc} =$	51,781.7 in <sup>3</sup>
Section modulus for the extreme <u>top</u> fiber slab	$S_{ts} =$	36,232.6 in <sup>3</sup>

### Shear Forces and Bending Moments

#### DEAD LOADS

Beam self-weight	$W_{beam} =$	0.799 k/f
8 in. deck weight	$W_{deck} =$	1.200 k/f
1/2 in. haunch weight	$W_{haunch} =$	0.022 k/f

#### LRFD Specifications: Art. 4.6.2.2.1

Width of Deck Constant		OK
Number of beams is not less than four $N_b =$	4	OK
Roadway part of the overhang, $d_o \leq 3.0$ ft, $d_o =$	1.5	OK
Curvature in plans is less than $4^\circ =$	0	OK
Cross-section of the bridge is consistent with one of the cross sections given by LRFD specs		OK

Barrier and wearing surface loads are equally distributed among the 4 beams

Barrier Wt	$W_t =$	0.150 k/f
Dead load of future wearing surface	$DW =$	0.263 k/f

LIVE LOADS		
Fire truck live load front load (Point A)	$P_{live} =$	48.0 kips
Fire truck live load back load (Point B)	$P_{live} =$	22.0 kips
distance between two loads		19.2 ft
distance from nearest edge to point A	$x_a =$	59.0 ft
distance from nearest edge to point B	$x_b =$	39.8 ft
LRFD Specifications: Art. 4.6.2.2.1		
Width of Deck Constant		OK
Number of beams is not less than four $N_b =$	4	OK
Beams are parallel and approximately of the same stiffness		OK
Roadway part of the overhang, $d_o \leq 3.0$ ft, $d_o =$	1.5	OK
Curvature in plans is less than $4^\circ =$	0	OK

Barrier and wearing surface loads are equally distributed among the 4 beams

Bridge Type-- "k" (LRFD Table 4.6.2.2.1-1)		
Number of design lanes = w/12	=	3 lanes

**Distribution Factor for Bending Moment:**

Beams spacing	$S =$	12.0 ft
Depth of concrete slab	$t_s =$	7.5 in
Beam Span	$L =$	120.0 ft
Number of Beams	$N_b =$	4
Modular ratio between beam & deck materials	$n =$	1.5051
Longitudinal stiffness parameter	$K_B =$	2,627,577.61 in <sup>4</sup>

at center span:		
$DFM = 0.75 + \left(\frac{S}{9.5}\right)^{0.6} * \left(\frac{S}{L}\right)^{0.2} * \left(\frac{K_B}{12 * L * n * t_s^3}\right)^{0.1}$		
	DFM =	0.915 lanes/beam

0.905 Controls

one design lane loaded:		
$DFM = 0.75 + \left(\frac{S}{14}\right)^{0.4} * \left(\frac{S}{L}\right)^{0.2} * \left(\frac{K_B}{12 * L * n * t_s^3}\right)^{0.1}$		
	DFM =	0.621 lanes/beam

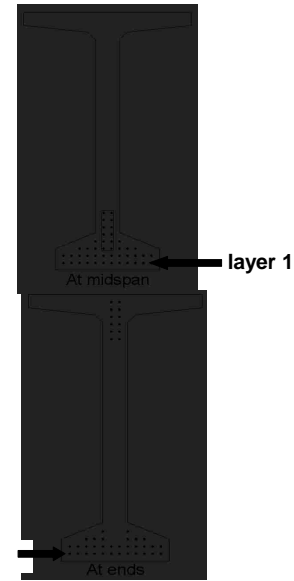
**Distribution Factor for Shear Force**

both end spans and center span:		
$DFV = 0.2 + \left(\frac{S}{12}\right) - \left(\frac{S}{35}\right)^2$		
	DFV =	1.082 lanes/beam

1.082 Controls

one design lane loaded:		
$DFV = 0.36 + \left(\frac{S}{25}\right)$		
	DFV =	0.840 lanes/beam

	At Midspan		At Ends	
from bottom	No. of	Distance from Bottom	No. of	Distance from Bottom
layer 1	12	2	12	2
layer 2	12	4	12	4
layer 3	8	6	6	6
layer 4	4	8	2	8
layer 5	2	10	-	-
layer 6	2	12	-	-
layer 7	2	14	-	-
layer 8	2	16	-	-
layer 9	-	-	2	60
layer 10	-	-	2	62
layer 11	-	-	2	64
layer 12	-	-	2	66
layer 13	-	-	2	68
layer 14	-	-	2	70
<b>Harped Strand Group (included in above totals)</b>				
layer 3	2	6		
layer 4	2	8		
layer 5	2	10		
layer 6	2	12		
layer 7	2	14		
layer 8	2	16		



distance from the center of gravity of strands to the bottom fiber of the beam = 7% of the beam depth	$y_{bs} =$	5.82 in
strand eccentricity at midspan = $(y_c - y_{bs})$	$e_c =$	30.78 in

layer 1

**Prestress Losses**

**ELASTIC SHORTENING**

assumed loss	=	9.00%
Force per strand at transfer		
layer 1	=	28.9 kips
layer 2	=	28.9 kips
layer 3	=	28.9 kips
layer 4	=	28.9 kips
layer 5	=	28.9 kips
layer 6	=	28.9 kips
layer 7	=	28.9 kips
layer 8	=	28.9 kips
layer 9	=	28.9 kips
layer 10	=	28.9 kips
layer 11	=	28.9 kips
layer 12	=	28.9 kips
layer 13	=	28.9 kips
layer 14	=	28.9 kips

Total prestressing force at release	$P_i =$	at midspan 1271.6 kips	at endspan 1271.6 kips
Sum of concrete stresses at the center of gravity of prestressing tendons due to prestressing force at transfer and the self-weight of the member at sections of maximum moment	$f_{cgp} =$	2.938 ksi	2.938 ksi

Loss due to shortening		at midspan	at endspan
layer 1	$\Delta f_{PES} =$	17.0 ksi	17.0 ksi
layer 2	$\Delta f_{PES} =$	17.0 ksi	17.0 ksi
layer 3	$\Delta f_{PES} =$	17.0 ksi	17.0 ksi
layer 4	$\Delta f_{PES} =$	17.0 ksi	17.0 ksi
layer 5	$\Delta f_{PES} =$	17.0 ksi	
layer 6	$\Delta f_{PES} =$	17.0 ksi	
layer 7	$\Delta f_{PES} =$	17.0 ksi	
layer 8	$\Delta f_{PES} =$	17.0 ksi	
layer 9	$\Delta f_{PES} =$		17.0 ksi
layer 10	$\Delta f_{PES} =$		17.0 ksi
layer 11	$\Delta f_{PES} =$		17.0 ksi
layer 12	$\Delta f_{PES} =$		17.0 ksi
layer 13	$\Delta f_{PES} =$		17.0 ksi
layer 14	$\Delta f_{PES} =$		17.0 ksi

**SHRINKAGE**

Shrinkage = (17-0.15*Relative Humidity)	$\Delta f_{PSR} =$	6.5 ksi	← assume relative humidity = 70%
---	--------------------	---------	----------------------------------

**CREEP OF CONCRETE**

Change of stresses at center of gravity of prestressing due to permanent loads except the loads acting at time of applying prestressing force, calculated at the same section as $f_{cgp}$	$\Delta f_{cdp} =$	1.566 ksi	
loss due to creep	$\Delta f_{PCR} =$	at midspan 24.3 ksi	at endspan 24.3 ksi

**RELAXATION OF PRESTRESSING STRANDS**

loss due to relaxation after transfer		at midspan	at endspan
layer 1	$\Delta f_{PR2} =$	2.1 ksi	2.1 ksi
layer 2	$\Delta f_{PR2} =$	2.1 ksi	2.1 ksi
layer 3	$\Delta f_{PR2} =$	2.1 ksi	2.1 ksi
layer 4	$\Delta f_{PR2} =$	2.1 ksi	2.1 ksi
layer 5	$\Delta f_{PR2} =$	2.1 ksi	
layer 6	$\Delta f_{PR2} =$	2.1 ksi	
layer 7	$\Delta f_{PR2} =$	2.1 ksi	
layer 8	$\Delta f_{PR2} =$	2.1 ksi	
layer 9	$\Delta f_{PR2} =$		2.1 ksi
layer 10	$\Delta f_{PR2} =$		2.1 ksi
layer 11	$\Delta f_{PR2} =$		2.1 ksi
layer 12	$\Delta f_{PR2} =$		2.1 ksi
layer 13	$\Delta f_{PR2} =$		2.1 ksi
layer 14	$\Delta f_{PR2} =$		2.1 ksi

**TOTAL LOSSES AT TRANSFER**

total loss  $\Delta f_{pES} = \Delta f_{pi}$

stress in tendons after transfer  $f_{pt} = f_{pr} - \Delta f_{pi}$

		at midspan	at endspan
layer 1	$f_{pt} =$	190.6 ksi	190.6 ksi
layer 2	$f_{pt} =$	190.6 ksi	190.6 ksi
layer 3	$f_{pt} =$	190.6 ksi	190.6 ksi
layer 4	$f_{pt} =$	190.6 ksi	190.6 ksi
layer 5	$f_{pt} =$	190.6 ksi	
layer 6	$f_{pt} =$	190.6 ksi	
layer 7	$f_{pt} =$	190.6 ksi	
layer 8	$f_{pt} =$	190.6 ksi	
layer 9	$f_{pt} =$		190.6 ksi
layer 10	$f_{pt} =$		190.6 ksi
layer 11	$f_{pt} =$		190.6 ksi
layer 12	$f_{pt} =$		190.6 ksi
layer 13	$f_{pt} =$		190.6 ksi
layer 14	$f_{pt} =$		190.6 ksi

force per strand =  $f_{pt} \times \text{strand area}$

		at midspan	at endspan
layer 1	=	29.2 kips	29.2 kips
layer 2	=	29.2 kips	29.2 kips
layer 3	=	29.2 kips	29.2 kips
layer 4	=	29.2 kips	29.2 kips
layer 5	=	29.2 kips	
layer 6	=	29.2 kips	
layer 7	=	29.2 kips	
layer 8	=	29.2 kips	
layer 9	=		29.2 kips
layer 10	=		29.2 kips
layer 11	=		29.2 kips
layer 12	=		29.2 kips
layer 13	=		29.2 kips
layer 14	=		29.2 kips
Total prestressing force after transfer	$P_i =$	1284.8 kips	1284.8 kips

Initial loss =  $(\Delta f_{pi}) / (f_{pi})$

		at midspan	at endspan
layer 1	% =	8.2%	8.2%
layer 2	% =	8.2%	8.2%
layer 3	% =	8.2%	8.2%
layer 4	% =	8.2%	8.2%
layer 5	% =	8.2%	
layer 6	% =	8.2%	
layer 7	% =	8.2%	
layer 8	% =	8.2%	
layer 9	% =		8.2%
layer 10	% =		8.2%
layer 11	% =		8.2%
layer 12	% =		8.2%
layer 13	% =		8.2%
layer 14	% =		8.2%

OK  
OK  
OK  
OK  
OK  
OK  
OK  
OK  
OK  
OK  
OK  
OK  
OK  
OK  
OK



**TOTAL LOSSES AT SERVICE LOADS**

Total Losses		at midspan	at endspan
layer 1	$\Delta f_{pT} =$	49.9 ksi	49.9 ksi
layer 2	$\Delta f_{pT} =$	49.9 ksi	49.9 ksi
layer 3	$\Delta f_{pT} =$	49.9 ksi	49.9 ksi
layer 4	$\Delta f_{pT} =$	49.9 ksi	49.9 ksi
layer 5	$\Delta f_{pT} =$	49.9 ksi	
layer 6	$\Delta f_{pT} =$	49.9 ksi	
layer 7	$\Delta f_{pT} =$	49.9 ksi	
layer 8	$\Delta f_{pT} =$	49.9 ksi	
layer 9	$\Delta f_{pT} =$		49.9 ksi
layer 10	$\Delta f_{pT} =$		49.9 ksi
layer 11	$\Delta f_{pT} =$		49.9 ksi
layer 12	$\Delta f_{pT} =$		49.9 ksi
layer 13	$\Delta f_{pT} =$		49.9 ksi
layer 14	$\Delta f_{pT} =$		49.9 ksi

Stress in tendon after all losses =  $f_{pe} - \Delta f_{pT}$

		at midspan	at endspan
layer 1	$f_{pe} =$	157.7 ksi	157.7 ksi
layer 2	$f_{pe} =$	157.7 ksi	157.7 ksi
layer 3	$f_{pe} =$	157.7 ksi	157.7 ksi
layer 4	$f_{pe} =$	157.7 ksi	157.7 ksi
layer 5	$f_{pe} =$	157.7 ksi	
layer 6	$f_{pe} =$	157.7 ksi	
layer 7	$f_{pe} =$	157.7 ksi	
layer 8	$f_{pe} =$	157.7 ksi	
layer 9	$f_{pe} =$		157.7 ksi
layer 10	$f_{pe} =$		157.7 ksi
layer 11	$f_{pe} =$		157.7 ksi
layer 12	$f_{pe} =$		157.7 ksi
layer 13	$f_{pe} =$		157.7 ksi
layer 14	$f_{pe} =$		157.7 ksi

check prestressing stress limit at service limit state:  $f_{pe} \leq 0.8 \cdot f_{py}$

layer 1	=	199.7 ksi
layer 2	=	199.7 ksi
layer 3	=	199.7 ksi
layer 4	=	199.7 ksi
layer 5	=	199.7 ksi
layer 6	=	199.7 ksi
layer 7	=	199.7 ksi
layer 8	=	199.7 ksi
layer 9	=	199.7 ksi
layer 10	=	199.7 ksi
layer 11	=	199.7 ksi
layer 12	=	199.7 ksi
layer 13	=	199.7 ksi
layer 14	=	199.7 ksi

OK  
OK  
OK  
OK  
OK  
OK  
OK  
OK  
OK  
OK  
OK  
OK  
OK  
OK

force per strand =  $f_{pe} \cdot \text{strand area}$

		at midspan	at endspan
layer 1	=	24.1 kips	24.1 kips
layer 2	=	24.1 kips	24.1 kips
layer 3	=	24.1 kips	24.1 kips
layer 4	=	24.1 kips	24.1 kips
layer 5	=	24.1 kips	
layer 6	=	24.1 kips	
layer 7	=	24.1 kips	
layer 8	=	24.1 kips	
layer 9	=		24.1 kips
layer 10	=		24.1 kips
layer 11	=		24.1 kips
layer 12	=		24.1 kips
layer 13	=		24.1 kips
layer 14	=		24.1 kips

Total prestressing force after all losses		at midspan	at endspan
$P_{pe} =$		1061.7 kips	1061.7 kips

Final losses, % =  $(\Delta f_{pr})/f_{pi}$

layer 1	% =	24.0%	24.0%
layer 2	% =	24.0%	24.0%
layer 3	% =	24.0%	24.0%
layer 4	% =	24.0%	24.0%
layer 5	% =	24.0%	
layer 6	% =	24.0%	
layer 7	% =	24.0%	
layer 8	% =	24.0%	
layer 9	% =		24.0%
layer 10	% =		24.0%
layer 11	% =		24.0%
layer 12	% =		24.0%
layer 13	% =		24.0%
layer 14	% =		24.0%
Average final losses, %	% =	24.0%	24.0%

**Stresses at Transfer**

**STRESS LIMITS FOR CONCRETE**

Compression = $0.6f'_{ci}$	$f_{ci}$ =	3.300 ksi
Tension		
without bonded reinforcement = $-0.0948 \cdot \sqrt{f'_{ci}} \leq -0.2$	=	-0.200 ksi
with bonded auxiliary reinforcement = $-0.22 \cdot \sqrt{f'_{ci}}$	=	-0.016 ksi

**STRESSES AT TRANSFER LENGTH SECTION**

Transfer Length = $60 \cdot (\text{strand diameter})$	=	2.5 ft	} Calcs for eccentricity (see 9.6.7.2)
Bending moment at transfer length	$M_g$ =	116.4 ft-kips	
center of 12 strands to top fiber of beam at the end	=	7.00 in	
center of 12 strands to bottom fiber of beam at the harp point	=	11.00 in	
center of 12 strands and top fiber of beam at transfer length	=	10.78 in	
center of gravity of 32 strands and bottom fiber of beam	=	3.88 in	
center of gravity of all strands and the bottom fiber of beam at transfer length	=	19.51 in	
center of gravity of all strands and the bottom fiber of beam at the end	=	20.55 in	
Eccentricity of the strand group at transfer length:	$e_n$ =	17.09 in	
Eccentricity at end of beam:	$e$ =	16.05 in	

$$f_t = \frac{P_i}{A} - \frac{P_i e}{S_t} + \frac{M_g}{S_t} \qquad f_b = \frac{P_i}{A} + \frac{P_i e}{S_b} - \frac{M_g}{S_b}$$

		<b>at midspan</b>	<b>at endspan</b>	
Top stress at top fiber of beam	$f_t$ =	0.342 ksi	0.342 ksi	OK
Bottom stress at bottom fiber of the beam	$f_b$ =	3.021 ksi	3.021 ksi	OK

**STRESSES AT HARP POINT**

Bending moment due to beam weight at 0.3L	$M_g$ =	1188.0 ft-kips		
Top stress at top fiber of beam	$f_t$ =	0.035 ksi	0.035 ksi	OK
Bottom stress at bottom fiber of the beam	$f_b$ =	3.300 ksi	3.300 ksi	OK

**STRESSES AT MIDSPAN**

Bending moment due to beam weight at 0.5L	$M_g$ =	1414.3 ft-kips		
Top stress at top fiber of beam	$f_t$ =	0.220 ksi	0.211 ksi	OK
Bottom stress at bottom fiber of the beam	$f_b$ =	3.144 ksi	3.189 ksi	OK

**HOLD-DOWN FORCES**

assume stress in strand before losses =  $0.8f_u$

layer 1	=	221.4 ksi
layer 2	=	221.4 ksi
layer 3	=	221.4 ksi
layer 4	=	221.4 ksi
layer 5	=	221.4 ksi
layer 6	=	221.4 ksi
layer 7	=	221.4 ksi
layer 8	=	221.4 ksi
layer 9	=	221.4 ksi
layer 10	=	221.4 ksi
layer 11	=	221.4 ksi
layer 12	=	221.4 ksi
layer 13	=	221.4 ksi
layer 14	=	221.4 ksi

prestress force per strand before any losses:

layer 1	=	33.9 kips
layer 2	=	33.9 kips
layer 3	=	33.9 kips
layer 4	=	33.9 kips
layer 5	=	33.9 kips
layer 6	=	33.9 kips
layer 7	=	33.9 kips
layer 8	=	33.9 kips
layer 9	=	33.9 kips
layer 10	=	33.9 kips
layer 11	=	33.9 kips
layer 12	=	33.9 kips
layer 13	=	33.9 kips
layer 14	=	33.9 kips
Harp Angle	$\psi =$	7.2 °

Hold-down force/strand

layer 1	=	4.4 kips/strand
layer 2	=	4.4 kips/strand
layer 3	=	4.4 kips/strand
layer 4	=	4.4 kips/strand
layer 5	=	4.4 kips/strand
layer 6	=	4.4 kips/strand
layer 7	=	4.4 kips/strand
layer 8	=	4.4 kips/strand
layer 9	=	4.4 kips/strand
layer 10	=	4.4 kips/strand
layer 11	=	4.4 kips/strand
layer 12	=	4.4 kips/strand
layer 13	=	4.4 kips/strand
layer 14	=	4.4 kips/strand
Total hold-down force	=	53.39 kips

### Stresses at Service Loads

#### STRESS LIMITS FOR CONCRETE

Compression:

Due to permanent loads for load combination Service I

for the precast beam	=	3.150 ksi
for deck	=	1.391 ksi

Due to permanent and transient loads for load combination Service I

for the precast beam	=	4.200 ksi
for deck	=	1.854 ksi

Tension:

Load Combination Service III

for the precast beam	=	-0.016 ksi
----------------------	---	------------

#### STRESSES AT MIDSPAN

Compression stresses at top fiber of beam	at midspan	at endspan	
$f_t = \frac{P_{pe}}{A} - \frac{P_{pe}e}{S_x} + \frac{(M_p + M_s)}{S_x} - \frac{(M_{ws} + M_d)}{S_{ty}}$			
Due to permanent loads	$f_{tp} =$	2.047 ksi	2.047 ksi
$f_{tp} = \frac{P_{pe}}{A} - \frac{P_{pe}e}{S_x} + \frac{(M_p + M_s)}{S_x} + \frac{(M_{ws} + M_d)}{S_{ty}} + \frac{(M_{L11})}{S_{ty}}$			
Due to permanent loads and transient loads	$f_{tp} =$	2.518 ksi	2.518 ksi
Compression stresses at top fiber of deck	at midspan	at endspan	
$f_{tc} = \frac{(M_{ws} + M_d)}{S_{tr}}$			
Due to permanent loads	$f_{tc} =$	0.042 ksi	0.042 ksi
$f_{tc} = \frac{(M_{ws} + M_d + M_{L11})}{S_{tr}}$			
Due to permanent loads and transient loads	$f_{tc} =$	0.487 ksi	0.487 ksi
Tension stresses at top fiber of deck	at midspan	at endspan	
$f_{ty} = \frac{P_{pe}}{A} - \frac{P_{pe}e}{S_y} - \frac{(M_p + M_s)}{S_y} - \frac{(M_{ws} + M_d + C.8 * M_{L11})}{S_{tr}}$			
Load Combination Service III	$f_{ty} =$	-0.429 ksi	-0.429 ksi

OK

OK

OK

OK

OK

**Strength Limit State**

**POSITIVE MOMENT SECTION**

$M_u = 1.25DC+1.5DW+1.75(LL+IM)$	$M_u =$	8381.5 ft-kips
effective length factor for compression members		
layer 1	k =	0.28
layer 2	k =	0.28
layer 3	k =	0.28
layer 4	k =	0.28
layer 5	k =	0.28
layer 6	k =	0.28
layer 7	k =	0.28
layer 8	k =	0.28
layer 9	k =	0.28
layer 10	k =	0.28
layer 11	k =	0.28
layer 12	k =	0.28
layer 13	k =	0.28
layer 14	k =	0.28
	c =	7.3 ft-kips

average stress in prestressing steel

layer 1	$f_{ps} =$	269.2 ksi
layer 2	$f_{ps} =$	269.2 ksi
layer 3	$f_{ps} =$	269.2 ksi
layer 4	$f_{ps} =$	269.2 ksi
layer 5	$f_{ps} =$	269.2 ksi
layer 6	$f_{ps} =$	269.2 ksi
layer 7	$f_{ps} =$	269.2 ksi
layer 8	$f_{ps} =$	269.2 ksi
layer 9	$f_{ps} =$	269.2 ksi
layer 10	$f_{ps} =$	269.2 ksi
layer 11	$f_{ps} =$	269.2 ksi
layer 12	$f_{ps} =$	269.2 ksi
layer 13	$f_{ps} =$	269.2 ksi
layer 14	$f_{ps} =$	269.2 ksi

nominal flexure resistance

	a =	6.23 in
$M_r = \Phi M_n, \Phi = 1.00$	$\Phi M_n =$	10733.5 ft-kips

OK

**NEGATIVE MOMENT SECTION**

$M_u = 1.25DC+1.5DW+1.75(LL+IM)$	$M_u =$	-4837.2 ft-kips
	a =	0.19 in
	$\Phi M_n =$	4504.5 ft-kips

NOT OK

**Shear Design**

**CRITICAL SECTION AT 0.59**

$V_u = 1.25DC+1.5DW+1.75(LL+IM)$	$V_u =$	405.0 kips
$M_u = 1.25DC+1.5DW+1.75(LL+IM)$	$M_u =$	-2684.4 ft-kips
or		
$V_u = 1.25DC+1.5DW+1.75(LL+IM)$	$V_u =$	364.8 kips
$M_u = 1.25DC+1.5DW+1.75(LL+IM)$	$M_u =$	-2877.0 ft-kips
max shear	$V_u =$	405.0 kips
max moment	$M_u =$	2877.0 ft-kips
Shear depth	$d_v =$	73.19 in
Applied factored normal force at the section	$N_u =$	0
Angle of diagonal compressive stresses	$\theta =$	36.00 °

**STRAIN IN FLEXURAL TENSION REINFORCEMENT**

$$\epsilon_x = \frac{\frac{M}{d_v} + 0.5N_u + 0.5V_u \cot \theta - A_{ps} f_{ps}}{E_s A_s + E_p A_{ps}} \leq 0.002$$

		at midspan	at endspan
resultant compressive stress at centroid	$f_{pc} =$	1.030 ksi	1.030 ksi
effective stress in prestressing strand after all losses			
layer 1	$f_{po} =$	163.0 ksi	163.0 ksi
layer 2	$f_{po} =$	163.0 ksi	163.0 ksi
layer 3	$f_{po} =$	163.0 ksi	163.0 ksi
layer 4	$f_{po} =$	163.0 ksi	163.0 ksi
layer 5	$f_{po} =$	163.0 ksi	
layer 6	$f_{po} =$	163.0 ksi	
layer 7	$f_{po} =$	163.0 ksi	
layer 8	$f_{po} =$	163.0 ksi	
layer 9	$f_{po} =$		163.0 ksi
layer 10	$f_{po} =$		163.0 ksi
layer 11	$f_{po} =$		163.0 ksi
layer 12	$f_{po} =$		163.0 ksi
layer 13	$f_{po} =$		163.0 ksi
layer 14	$f_{po} =$		163.0 ksi

		at midspan	at endspan
strain in flexural tension			
layer 1	$\epsilon_x =$	0.002000	0.002000
layer 2	$\epsilon_x =$	0.002000	0.002000
layer 3	$\epsilon_x =$	0.002000	0.002000
layer 4	$\epsilon_x =$	0.002000	0.002000
layer 5	$\epsilon_x =$	0.002000	
layer 6	$\epsilon_x =$	0.002000	
layer 7	$\epsilon_x =$	0.002000	
layer 8	$\epsilon_x =$	0.002000	
layer 9	$\epsilon_x =$		0.002000
layer 10	$\epsilon_x =$		0.002000
layer 11	$\epsilon_x =$		0.002000
layer 12	$\epsilon_x =$		0.002000
layer 13	$\epsilon_x =$		0.002000
layer 14	$\epsilon_x =$		0.002000

**Deflection and Camber**

		at midspan	at endspan
Deflection due to Prestressing Force at Transfer	$\Delta_p =$	3.97 in	3.97 in
Deflection due to Beam Self-Weight at Transfer	$\Delta_g =$	-1.49 in	
Deflection due to Beam Self-Weight at Erection	$\Delta_g =$	-1.44 in	
Deflection due to Haunch and Deck	$\Delta_g =$	-1.95 in	

Deflection due to total self weight	$\Delta_{sw} =$	0.59 in
-------------------------------------	-----------------	---------

Total Deflection at transfer	$\Delta =$	2.48 in	2.48 in
Total Deflection at erection	$\Delta =$	4.49 in	4.49 in

Live load deflection limit = span/800	$=$	1.80 in
Deflection due to live load and impact	$\Delta_L =$	-0.90 in

OK

Deflection due to fire truck	$\Delta_L =$	-0.8081 in
Total Deflection after fire with fire truck	$\Delta =$	3.7472 in

OK

**Parametric Design: US Route 7 Case Study**  
**Beam Design: 3/8" Strand**  
**Fire Exposure Status: Undamaged**

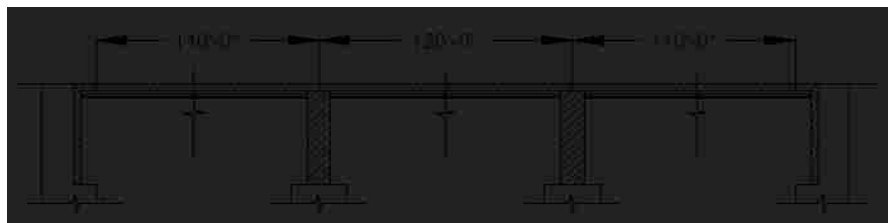
(PCI Bridge Design Manual Section 9.6)



**Material Properties**

CAST-IN-PLACE SLAB			
Actual Thickness	$t_{as} =$		8.0 in
Wearing Surface	$=$		0.5 in
Structural thickness = Actual - Wearing Surface	$t_s =$		7.5 in
Compressive Strength	$f'_c =$		4.00 ksi
Unit Weight	$w_c =$		150.0 pcf
Stress factor of compression block	$\beta_1 =$		0.85

BEAMS: AASHTO-PCI, BT-72 BULB-TEE			
Strength at release	$f_{ci} =$		5.5 ksi
Strength at 28 days	$f'_c =$		7 ksi
Unit Weight	$w_c =$		150.0 pcf
Overall Beam Length:			
@ end spans	$L =$		110 ft
@ center span	$L =$		119 ft
Design Spans:			
Non-composite beam @ end spans	$L =$		109 ft
Non-composite beam @ center span	$L =$		118 ft
Composite beam @ end spans	$L =$		110 ft
Composite beam @ center span	$L =$		120 ft
Beam Spacing	$S =$		12 ft



**PRESTRESSING STRANDS**

Diameter of single strand	d =	0.4 in
Area of single strand	A =	0.085 in <sup>2</sup>
Temperature of Layer		
	layer 1 (bottom)	T = 68.00 °F
	layer 2	T = 68.00 °F
	layer 3	T = 68.00 °F
	layer 4	T = 68.00 °F
	layer 5	T = 68.00 °F
	layer 6	T = 68.00 °F
	layer 7	T = 68.00 °F
	layer 8	T = 68.00 °F
	layer 9	T = 68.00 °F
	layer 10	T = 68.00 °F
	layer 11	T = 68.00 °F
	layer 12	T = 68.00 °F
	layer 13	T = 68.00 °F
	layer 14	T = 68.00 °F
Ultimate Strength		
initial = 284 ksi	layer 1 (bottom)	f <sub>pu</sub> = 284 ksi
	layer 2	f <sub>pu</sub> = 284 ksi
	layer 3	f <sub>pu</sub> = 284 ksi
	layer 4	f <sub>pu</sub> = 284 ksi
	layer 5	f <sub>pu</sub> = 284 ksi
	layer 6	f <sub>pu</sub> = 284 ksi
	layer 7	f <sub>pu</sub> = 284 ksi
	layer 8	f <sub>pu</sub> = 284 ksi
	layer 9	f <sub>pu</sub> = 284 ksi
	layer 10	f <sub>pu</sub> = 284 ksi
	layer 11	f <sub>pu</sub> = 284 ksi
	layer 12	f <sub>pu</sub> = 284 ksi
	layer 13	f <sub>pu</sub> = 284 ksi
	layer 14	f <sub>pu</sub> = 284 ksi
Yield Strength		
initial = 257 ksi	layer 1 (bottom)	f <sub>py</sub> = 257 ksi
	layer 2	f <sub>py</sub> = 257 ksi
	layer 3	f <sub>py</sub> = 257 ksi
	layer 4	f <sub>py</sub> = 257 ksi
	layer 5	f <sub>py</sub> = 257 ksi
	layer 6	f <sub>py</sub> = 257 ksi
	layer 7	f <sub>py</sub> = 257 ksi
	layer 8	f <sub>py</sub> = 257 ksi
	layer 9	f <sub>py</sub> = 257 ksi
	layer 10	f <sub>py</sub> = 257 ksi
	layer 11	f <sub>py</sub> = 257 ksi
	layer 12	f <sub>py</sub> = 257 ksi
	layer 13	f <sub>py</sub> = 257 ksi
	layer 14	f <sub>py</sub> = 257 ksi
<b>Stress Limits:</b>		
before transfer ≤ 0.75f <sub>pu</sub> (initial = 213.2)	layer 1 (bottom)	f <sub>pi</sub> = 213.2 ksi
	layer 2	f <sub>pi</sub> = 213.2 ksi
	layer 3	f <sub>pi</sub> = 213.2 ksi
	layer 4	f <sub>pi</sub> = 213.2 ksi
	layer 5	f <sub>pi</sub> = 213.2 ksi
	layer 6	f <sub>pi</sub> = 213.2 ksi
	layer 7	f <sub>pi</sub> = 213.2 ksi
	layer 8	f <sub>pi</sub> = 213.2 ksi
	layer 9	f <sub>pi</sub> = 213.2 ksi
	layer 10	f <sub>pi</sub> = 213.2 ksi
	layer 11	f <sub>pi</sub> = 213.2 ksi
	layer 12	f <sub>pi</sub> = 213.2 ksi
	layer 13	f <sub>pi</sub> = 213.2 ksi
	layer 14	f <sub>pi</sub> = 213.2 ksi

at service limit state (after all losses)  $\leq 0.80f_{py}$  (initial = 205.4)

layer 1 (bottom)	$f_{pe} =$	205.4 ksi
layer 2	$f_{pe} =$	205.4 ksi
layer 3	$f_{pe} =$	205.4 ksi
layer 4	$f_{pe} =$	205.4 ksi
layer 5	$f_{pe} =$	205.4 ksi
layer 6	$f_{pe} =$	205.4 ksi
layer 7	$f_{pe} =$	205.4 ksi
layer 8	$f_{pe} =$	205.4 ksi
layer 9	$f_{pe} =$	205.4 ksi
layer 10	$f_{pe} =$	205.4 ksi
layer 11	$f_{pe} =$	205.4 ksi
layer 12	$f_{pe} =$	205.4 ksi
layer 13	$f_{pe} =$	205.4 ksi
layer 14	$f_{pe} =$	205.4 ksi

Modulus of Elasticity

initial = 25898 ksi

layer 1 (bottom)	E =	25898.0 ksi
layer 2	E =	25898.0 ksi
layer 3	E =	25898.0 ksi
layer 4	E =	25898.0 ksi
layer 5	E =	25898.0 ksi
layer 6	E =	25898.0 ksi
layer 7	E =	25898.0 ksi
layer 8	E =	25898.0 ksi
layer 9	E =	25898.0 ksi
layer 10	E =	25898.0 ksi
layer 11	E =	25898.0 ksi
layer 12	E =	25898.0 ksi
layer 13	E =	25898.0 ksi
layer 14	E =	25898.0 ksi

### MILD STEEL REINFORCING BARS

Yield Strength

Layer 1 (Bottom)	$f_y =$	60.0 ksi	68.00 °F
Layer 2 (Top)	$f_y =$	60.0 ksi	68.00 °F

Modulus of Elasticity

Layer 1 (Bottom)	E =	29000.0 ksi
Layer 2 (Top)	E =	29000.0 ksi

Layer 1 (Bottom)

Area of steel at midspan (effective flange)	$A_{sm} =$	2.79 in <sup>2</sup>
Area of steel at endspan (effective flange)	$A_{se} =$	2.48 in <sup>2</sup>
Area of temperature and shrinkage steel (12" width)	$A_s =$	0.31 in <sup>2</sup>

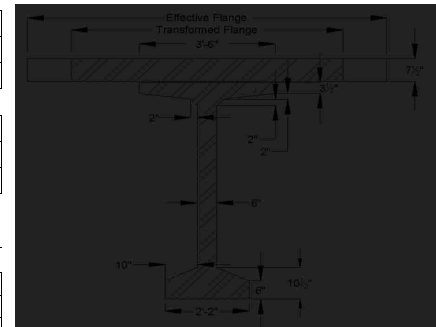
Layer 2 (Top)

Area of steel at midspan (effective flange)	$A_{sm} =$	12.6 in <sup>2</sup>
Area of steel at endspan (effective flange)	$A_{se} =$	12.4 in <sup>2</sup>
Area of temperature and shrinkage steel (12" width)	$A_s =$	0.2 in <sup>2</sup>

### Cross-sectional Properties

#### NON-COMPOSITE BEAM

Area of cross-section of beam	A =	767.0 in <sup>2</sup>
Overall depth of beam	H =	72.0 in
Moment of Inertia	I =	539,947 in <sup>4</sup>
Distance from centroid to extreme <u>bottom</u> fiber	$y_b =$	36.6 in
Distance from centroid to extreme <u>top</u> fiber	$y_t =$	35.4 in
Section modulus for the extreme <u>bottom</u> fiber	$S_b =$	14915.0 in <sup>3</sup>
Section modulus for the extreme <u>top</u> fiber	$S_t =$	15421.0 in <sup>3</sup>
Weight	$W_t =$	799.0 plf
Modulus of Elasticity = $33000 \cdot (W_c^{1.5}) \cdot (\sqrt{f'_c})$		
cast-in-place concrete deck	$E_{cs} =$	3834 ksi
precast beam at release	$E_{ci} =$	4496 ksi
precast beam at service loads	$E_c =$	5072 ksi





### COMPOSITE BEAM AT MIDSPAN

Effective Flange Width	$b_f =$	111.0 in	*min of three criteria
Modular Ratio = $E_{cs}/E_c$	$n =$	0.7559	
Transformed flange width	$=$	83.9 in	
Transformed flange area	$=$	629.3 in <sup>2</sup>	
Transformed haunch width	$=$	31.7 in	
Transformed haunch area	$=$	15.9 in <sup>2</sup>	
Deck-distance to top fiber	$y_t =$	3.75 in	

	Transformed Area	$y_b$	$Ay_b$	$A(y_{bc}-y_b)^2$	I	$I + A(y_{bc}-y_b)^2$
Beam	767.0 in <sup>2</sup>	36.60 in	28,072.2 in <sup>3</sup>	250,443 in <sup>4</sup>	539,947 in <sup>4</sup>	790,390 in <sup>4</sup>
Haunch	15.9 in <sup>2</sup>	72.25 in	1,146.9 in <sup>3</sup>	4,906 in <sup>4</sup>	0.33 in <sup>4</sup>	4,906 in <sup>4</sup>
Deck	629.3 in <sup>2</sup>	76.25 in	47,985.0 in <sup>3</sup>	293,069 in <sup>4</sup>	2,950 in <sup>4</sup>	296,019 in <sup>4</sup>
Total	1412.2 in <sup>2</sup>		77,204.1 in <sup>3</sup>			1,091,316 in <sup>4</sup>

Total area of Composite Section	$A_c =$	1412 in <sup>2</sup>
Overall Depth of the Composite Section	$h_c =$	80 in
Moment of Inertia	$I_c =$	1,091,316 in <sup>4</sup>
Distance from centroid to extreme <u>bottom</u> fiber of beam	$y_{bc} =$	54.67 in
Distance from centroid to extreme <u>top</u> fiber of beam	$y_{tg} =$	17.33 in
Distance from centroid to extreme <u>top</u> fiber of slab	$y_{tc} =$	25.33 in
Section modulus for the extreme <u>bottom</u> fiber of beam	$S_{bc} =$	19,961.9 in <sup>3</sup>
Section modulus for the extreme <u>top</u> fiber of beam	$S_{tg} =$	62,972.4 in <sup>3</sup>
Section modulus for the extreme <u>top</u> fiber slab	$S_{tc} =$	56,994.5 in <sup>3</sup>

### COMPOSITE BEAM AT ENDSpan

Effective Flange Width	$b_f =$	106.6 in	*min of three criteria
Modular Ratio = $E_{cs}/E_c$	$n =$	0.7559	
Transformed flange width	$=$	80.6 in	
Transformed flange area	$=$	604.4 in <sup>2</sup>	
Transformed haunch width	$=$	31.7 in	
Transformed haunch area	$=$	15.9 in <sup>2</sup>	
Deck-distance to top fiber	$y_{td} =$	3.75 in	

	Transformed Area	$y_t$	$Ay_t$	$A(y_{bc}-y_t)^2$	I	$I + A(y_{bc}-y_t)^2$
Beam	767.0 in <sup>2</sup>	36.60 in	28,072.2 in <sup>3</sup>	273,455 in <sup>4</sup>	539,947 in <sup>4</sup>	813,402 in <sup>4</sup>
Haunch	15.9 in <sup>2</sup>	72.25 in	1,146.9 in <sup>3</sup>	5,660 in <sup>4</sup>	0.33 in <sup>4</sup>	5,660 in <sup>4</sup>
Deck	604.4 in <sup>2</sup>	76.25 in	46,082.8 in <sup>3</sup>	215,472 in <sup>4</sup>	2,833 in <sup>4</sup>	218,305 in <sup>4</sup>
Total	1387.2 in <sup>2</sup>		75,302.0 in <sup>3</sup>			1,037,366 in <sup>4</sup>

Total area of Composite Section	$A_c =$	1387 in <sup>2</sup>
Overall Depth of the Composite Section	$h_c =$	80 in
Moment of Inertia	$I_c =$	1,037,366 in <sup>4</sup>
Distance from centroid to extreme <u>bottom</u> fiber of beam	$y_{bc} =$	54.28 in
Distance from centroid to extreme <u>top</u> fiber of beam	$y_{tg} =$	17.72 in
Distance from centroid to extreme <u>top</u> fiber of slab	$y_{tc} =$	25.72 in
Section modulus for the extreme <u>bottom</u> fiber of beam	$S_{bc} =$	19,110.7 in <sup>3</sup>
Section modulus for the extreme <u>top</u> fiber of beam	$S_{tg} =$	58,548.3 in <sup>3</sup>
Section modulus for the extreme <u>top</u> fiber slab	$S_{tc} =$	40,336.0 in <sup>3</sup>

### Shear Forces and Bending Moments

#### DEAD LOADS

Beam self-weight	$w_{beam} =$	0.799 k/f
8 in. deck weight	$w_{deck} =$	1.200 k/f
1/2 in. haunch weight	$w_{haunch} =$	0.022 k/f

LRFD Specifications: Art. 4.6.2.2.1

Width of Deck Constant	4	OK
Number of beams is not less than four $N_b =$	4	OK
Roadway part of the overhang, $d_b \leq 3.0$ ft, $d_b =$	1.5	OK
Curvature in plans is less than 4° =	0	OK
Cross-section of the bridge is consistent with one of the cross sections given by LRFD specs		OK

Barrier and wearing surface loads are equally distributed among the 4 beams

Barrier Wt	$W_t =$	0.150 k/f
Dead load of future wearing surface	$DW =$	0.263 k/f

LIVE LOADS		
Fire truck live load front load (Point A)	$P_{live} =$	48.0 kips
Fire truck live load back load (Point B)	$P_{live} =$	22.0 kips
distance between two loads		19.2 ft
distance from nearest edge to point A	$x_a =$	59.0 ft
distance from nearest edge to point B	$x_b =$	39.8 ft
LRFD Specifications: Art. 4.6.2.2.1		
Width of Deck Constant		OK
Number of beams is not less than four $N_b =$	4	OK
Beams are parallel and approximately of the same stiffness		OK
Roadway part of the overhang, $d_a \leq 3.0$ ft, $d_b =$	1.5	OK
Curvature in plans is less than $4^\circ =$	0	OK

Barrier and wearing surface loads are equally distributed among the 4 beams

Bridge Type-- "k" (LRFD Table 4.6.2.2.1-1)

Number of design lanes =  $w/12 =$  3 lanes

**Distribution Factor for Bending Moment:**

Beams spacing	$S =$	12.0 ft
Depth of concrete slab	$t_c =$	7.5 in
Beam Span	$L =$	120.0 ft
Number of Beams	$N_b =$	4
Modular ratio between beam & deck materials	$n =$	1.3229
Longitudinal stiffness parameter	$K_g =$	2,309,429.79 in <sup>4</sup>

at center span:		
$DFM = 0.75 + \left(\frac{S}{9.5}\right)^{0.6} + \left(\frac{S}{L}\right)^{0.2} + \left(\frac{K_g}{12 * L * t_c^3}\right)^{0.1}$		
	DFM =	0.905 lanes/beam

0.905 Controls

one design lane loaded:		
$DFM = 0.75 + \left(\frac{S}{14}\right)^{0.4} + \left(\frac{S}{L}\right)^{0.3} + \left(\frac{K_g}{12 * L * t_c^3}\right)^{0.1}$		
	DFM =	0.614 lanes/beam

**Distribution Factor for Shear Force**

both end spans and center span:		
$DFV = 0.2 + \left(\frac{S}{12}\right) - \left(\frac{S}{35}\right)^2$		
	DFV =	1.082 lanes/beam

1.082 Controls

one design lane loaded:		
$DFV = 0.36 + \left(\frac{S}{25}\right)$		
	DFV =	0.840 lanes/beam

from bottom	At Midspan		At Ends	
	No. of	Distance from Bottom	No. of	Distance from Bottom
layer 1	14	2	14	2
layer 2	14	3.5	14	3.5
layer 3	14	5	14	5
layer 4	10	6.5	8	6.5
layer 5	4	8	2	8
layer 6	2	10	-	-
layer 7	2	12	-	-
layer 8	2	14	-	-
layer 9	2	16	2	60
layer 10	-	-	2	62
layer 11	-	-	2	64
layer 12	-	-	2	66
layer 13	-	-	2	68
layer 14	-	-	2	70
	64		64	
<b>Harped Strand Group (included in above totals)</b>				
layer 3	2	6		
layer 4	2	8		
layer 5	2	10		
layer 6	2	12		
layer 7	2	14		
layer 8	2	16		

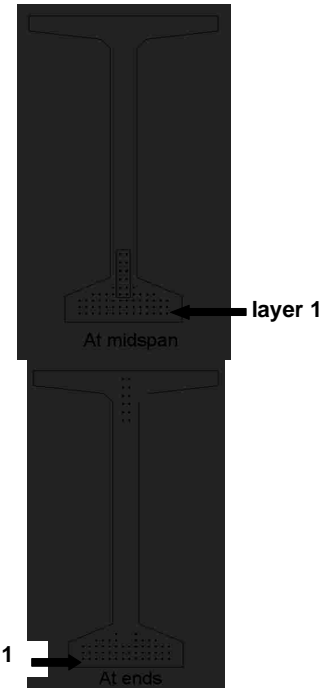
distance from the center of gravity of strands to the bottom fiber of the beam = 7% of the beam depth  
strand eccentricity at midspan =  $(y_b - y_{bs})$

$y_{bs} =$	5.44 in
$e_c =$	31.16 in

### Prestress Losses

#### ELASTIC SHORTENING

assumed loss	=	6.00%
Force per strand at transfer		
layer 1	=	17.0 kips
layer 2	=	17.0 kips
layer 3	=	17.0 kips
layer 4	=	17.0 kips
layer 5	=	17.0 kips
layer 6	=	17.0 kips
layer 7	=	17.0 kips
layer 8	=	17.0 kips
layer 9	=	17.0 kips
layer 10	=	17.0 kips
layer 11	=	17.0 kips
layer 12	=	17.0 kips
layer 13	=	17.0 kips
layer 14	=	17.0 kips



Total prestressing force at release	$P_i =$	at midspan 1088.0 kips	at endspan 1054.0 kips
Sum of concrete stresses at the center of gravity of prestressing tendons due to prestressing force at transfer and the self-weight of the member at sections of maximum moment	$f_{cgp} =$	2.412 ksi	2.307 ksi
Loss due to shortening		at midspan	at endspan
layer 1	$\Delta f_{PES} =$	13.9 ksi	13.3 ksi
layer 2	$\Delta f_{PES} =$	13.9 ksi	13.3 ksi
layer 3	$\Delta f_{PES} =$	13.9 ksi	13.3 ksi
layer 4	$\Delta f_{PES} =$	13.9 ksi	13.3 ksi
layer 5	$\Delta f_{PES} =$	13.9 ksi	13.3 ksi
layer 6	$\Delta f_{PES} =$	13.9 ksi	
layer 7	$\Delta f_{PES} =$	13.9 ksi	
layer 8	$\Delta f_{PES} =$	13.9 ksi	
layer 9	$\Delta f_{PES} =$	13.9 ksi	13.3 ksi
layer 10	$\Delta f_{PES} =$		13.3 ksi
layer 11	$\Delta f_{PES} =$		13.3 ksi
layer 12	$\Delta f_{PES} =$		13.3 ksi
layer 13	$\Delta f_{PES} =$		13.3 ksi
layer 14	$\Delta f_{PES} =$		13.3 ksi

SHRINKAGE		
Shrinkage = (17-0.15*Relative Humidity)	$\Delta f_{PSR} =$	6.5 ksi ← assume relative humidity = 70%

CREEP OF CONCRETE		
Change of stresses at center of gravity of prestressing due to permanent loads except the loads acting at time of applying prestressing force, calculated at the same section as $f_{csp}$	$\Delta f_{cdp} =$	1.587 ksi
		<b>at midspan</b> <b>at endspan</b>
loss due to creep	$\Delta f_{PCR} =$	17.8 ksi      16.6 ksi

RELAXATION OF PRESTRESSING STRANDS		
loss due to relaxation after transfer		<b>at midspan</b> <b>at endspan</b>
layer 1	$\Delta f_{pR2} =$	2.9 ksi      2.9 ksi
layer 2	$\Delta f_{pR2} =$	2.9 ksi      2.9 ksi
layer 3	$\Delta f_{pR2} =$	2.9 ksi      2.9 ksi
layer 4	$\Delta f_{pR2} =$	2.9 ksi      2.9 ksi
layer 5	$\Delta f_{pR2} =$	2.9 ksi      2.9 ksi
layer 6	$\Delta f_{pR2} =$	2.9 ksi      2.9 ksi
layer 7	$\Delta f_{pR2} =$	2.9 ksi      2.9 ksi
layer 8	$\Delta f_{pR2} =$	2.9 ksi      2.9 ksi
layer 9	$\Delta f_{pR2} =$	2.9 ksi      2.9 ksi
layer 10	$\Delta f_{pR2} =$	2.9 ksi      2.9 ksi
layer 11	$\Delta f_{pR2} =$	2.9 ksi      2.9 ksi
layer 12	$\Delta f_{pR2} =$	2.9 ksi      2.9 ksi
layer 13	$\Delta f_{pR2} =$	2.9 ksi      2.9 ksi
layer 14	$\Delta f_{pR2} =$	2.9 ksi      2.9 ksi

TOTAL LOSSES AT TRANSFER		
total loss $\Delta f_{pES} = \Delta f_{pi}$		
stress in tendons after transfer $f_{pt} = f_{pi} - \Delta f_{pi}$		
		<b>at midspan</b> <b>at endspan</b>
layer 1	$f_{pt} =$	199.3 ksi      199.9 ksi
layer 2	$f_{pt} =$	199.3 ksi      199.9 ksi
layer 3	$f_{pt} =$	199.3 ksi      199.9 ksi
layer 4	$f_{pt} =$	199.3 ksi      199.9 ksi
layer 5	$f_{pt} =$	199.3 ksi      199.9 ksi
layer 6	$f_{pt} =$	199.3 ksi      199.9 ksi
layer 7	$f_{pt} =$	199.3 ksi      199.9 ksi
layer 8	$f_{pt} =$	199.3 ksi      199.9 ksi
layer 9	$f_{pt} =$	199.3 ksi      199.9 ksi
layer 10	$f_{pt} =$	199.3 ksi      199.9 ksi
layer 11	$f_{pt} =$	199.3 ksi      199.9 ksi
layer 12	$f_{pt} =$	199.3 ksi      199.9 ksi
layer 13	$f_{pt} =$	199.3 ksi      199.9 ksi
layer 14	$f_{pt} =$	199.3 ksi      199.9 ksi
force per strand = $f_{pt} \times$ strand area		<b>at midspan</b> <b>at endspan</b>
layer 1	=	16.9 kips      17.0 kips
layer 2	=	16.9 kips      17.0 kips
layer 3	=	16.9 kips      17.0 kips
layer 4	=	16.9 kips      17.0 kips
layer 5	=	16.9 kips      17.0 kips
layer 6	=	16.9 kips      17.0 kips
layer 7	=	16.9 kips      17.0 kips
layer 8	=	16.9 kips      17.0 kips
layer 9	=	16.9 kips      17.0 kips
layer 10	=	16.9 kips      17.0 kips
layer 11	=	16.9 kips      17.0 kips
layer 12	=	16.9 kips      17.0 kips
layer 13	=	16.9 kips      17.0 kips
layer 14	=	16.9 kips      17.0 kips
Total prestressing force after transfer	$P_i =$	1047.8 kips      1054.0 kips

Initial loss =  $(\Delta f_{pi}) / (f_{pi})$

		at midspan	at endspan	
layer 1	% =	6.5%	6.2%	OK
layer 2	% =	6.5%	6.2%	OK
layer 3	% =	6.5%	6.2%	OK
layer 4	% =	6.5%	6.2%	OK
layer 5	% =	6.5%	6.2%	OK
layer 6	% =	6.5%		OK
layer 7	% =	6.5%		OK
layer 8	% =	6.5%		OK
layer 9	% =	6.5%	6.2%	OK
layer 10	% =		6.2%	OK
layer 11	% =		6.2%	OK
layer 12	% =		6.2%	OK
layer 13	% =		6.2%	OK
layer 14	% =		6.2%	OK

**TOTAL LOSSES AT SERVICE LOADS**

Total Losses		at midspan	at endspan
layer 1	$\Delta f_{pT} =$	41.1 ksi	40.5 ksi
layer 2	$\Delta f_{pT} =$	41.1 ksi	40.5 ksi
layer 3	$\Delta f_{pT} =$	41.1 ksi	40.5 ksi
layer 4	$\Delta f_{pT} =$	41.1 ksi	40.5 ksi
layer 5	$\Delta f_{pT} =$	41.1 ksi	40.5 ksi
layer 6	$\Delta f_{pT} =$	41.1 ksi	
layer 7	$\Delta f_{pT} =$	41.1 ksi	
layer 8	$\Delta f_{pT} =$	41.1 ksi	
layer 9	$\Delta f_{pT} =$	41.1 ksi	40.5 ksi
layer 10	$\Delta f_{pT} =$		40.5 ksi
layer 11	$\Delta f_{pT} =$		40.5 ksi
layer 12	$\Delta f_{pT} =$		40.5 ksi
layer 13	$\Delta f_{pT} =$		40.5 ksi
layer 14	$\Delta f_{pT} =$		40.5 ksi

Stress in tendon after all losses =  $f_{pi} - \Delta f_{pi}$

		at midspan	at endspan
layer 1	$f_{pe} =$	172.0 ksi	172.7 ksi
layer 2	$f_{pe} =$	172.0 ksi	172.7 ksi
layer 3	$f_{pe} =$	172.0 ksi	172.7 ksi
layer 4	$f_{pe} =$	172.0 ksi	172.7 ksi
layer 5	$f_{pe} =$	172.0 ksi	172.7 ksi
layer 6	$f_{pe} =$	172.0 ksi	
layer 7	$f_{pe} =$	172.0 ksi	
layer 8	$f_{pe} =$	172.0 ksi	
layer 9	$f_{pe} =$	172.0 ksi	172.7 ksi
layer 10	$f_{pe} =$		172.7 ksi
layer 11	$f_{pe} =$		172.7 ksi
layer 12	$f_{pe} =$		172.7 ksi
layer 13	$f_{pe} =$		172.7 ksi
layer 14	$f_{pe} =$		172.7 ksi

check prestressing stress limit at service limit state:  $f_{pe} \leq 0.8 \cdot f_{py}$

layer 1	=	205.4 ksi	OK
layer 2	=	205.4 ksi	OK
layer 3	=	205.4 ksi	OK
layer 4	=	205.4 ksi	OK
layer 5	=	205.4 ksi	OK
layer 6	=	205.4 ksi	OK
layer 7	=	205.4 ksi	OK
layer 8	=	205.4 ksi	OK
layer 9	=	205.4 ksi	OK
layer 10	=	205.4 ksi	OK
layer 11	=	205.4 ksi	OK
layer 12	=	205.4 ksi	OK
layer 13	=	205.4 ksi	OK
layer 14	=	205.4 ksi	OK

force per strand =  $f_{pe}$  \* strand area

		at midspan	at endspan
layer 1	=	14.6 kips	14.7 kips
layer 2	=	14.6 kips	14.7 kips
layer 3	=	14.6 kips	14.7 kips
layer 4	=	14.6 kips	14.7 kips
layer 5	=	14.6 kips	14.7 kips
layer 6	=	14.6 kips	
layer 7	=	14.6 kips	
layer 8	=	14.6 kips	
layer 9	=	14.6 kips	14.7 kips
layer 10	=		14.7 kips
layer 11	=		14.7 kips
layer 12	=		14.7 kips
layer 13	=		14.7 kips
layer 14	=		14.7 kips

Total prestressing force after all losses  $P_{pe} =$   
 Final losses, % =  $(\Delta f_{PT}) / (f_{pi})$

		at midspan	at endspan
$P_{pe} =$		935.9 kips	939.2 kips
layer 1	% =	19.3%	19.0%
layer 2	% =	19.3%	19.0%
layer 3	% =	19.3%	19.0%
layer 4	% =	19.3%	19.0%
layer 5	% =	19.3%	19.0%
layer 6	% =	19.3%	
layer 7	% =	19.3%	
layer 8	% =	19.3%	
layer 9	% =	19.3%	19.0%
layer 10	% =		19.0%
layer 11	% =		19.0%
layer 12	% =		19.0%
layer 13	% =		19.0%
layer 14	% =		19.0%
Average final losses, %	% =	19.3%	19.0%

### Stresses at Transfer

#### STRESS LIMITS FOR CONCRETE

Compression = $0.6f_{ci}$	$f_{ci} =$	3.300 ksi
Tension		
without bonded reinforcement = $-0.0948 \sqrt{f_{ci}} \leq -0.2$	$=$	-0.200 ksi
with bonded auxiliary reinforcement = $-0.22 \sqrt{f_{ci}}$	$=$	-0.016 ksi

#### STRESSES AT TRANSFER LENGTH SECTION

Transfer Length = $60 \times (\text{strand diameter})$	$=$	1.9 ft
Bending moment at transfer length	$M_g =$	87.7 ft-kips
center of 12 strands to top fiber of beam at the end	$=$	7.00 in
center of 12 strands to bottom fiber of beam at the harp point	$=$	11.00 in
center of 12 strands and top fiber of beam at transfer length	$=$	9.84 in
center of gravity of 32 strands and bottom fiber of beam	$=$	3.98 in
center of gravity of all strands and the bottom fiber of beam at transfer length	$=$	15.24 in
center of gravity of all strands and the bottom fiber of beam at the end	$=$	15.30 in
Eccentricity of the strand group at transfer length:	$e_h =$	21.36 in
Eccentricity at end of beam:	$e =$	21.30 in

Calcs for eccentricity (see 9.6.7.2)

$$f_t = \frac{P_i}{A} - \frac{P_i e}{S_t} + \frac{M_g}{S_t}$$

$$f_b = \frac{P_i}{A} + \frac{P_i e}{S_b} - \frac{M_g}{S_b}$$

		at midspan	at endspan
Top stress at top fiber of beam	$f_t =$	-0.017 ksi	-0.017 ksi
Bottom stress at bottom fiber of the beam	$f_b =$	2.906 ksi	2.906 ksi

OK  
OK

STRESSES AT HARP POINT			
Bending moment due to beam weight at 0.3L	$M_g =$	1188.0 ft-kips	
Top stress at top fiber of beam	$f_t =$	0.173 ksi	0.169 ksi
Bottom stress at bottom fiber of the beam	$f_b =$	2.736 ksi	2.621 ksi

OK  
OK

STRESSES AT MIDSPAN			
Bending moment due to beam weight at 0.5L	$M_g =$	1414.3 ft-kips	
Top stress at top fiber of beam	$f_t =$	0.320 ksi	0.345 ksi
Bottom stress at bottom fiber of the beam	$f_b =$	2.554 ksi	2.438 ksi

OK  
OK

#### HOLD-DOWN FORCES

assume stress in strand before losses =  $0.8f_u$

layer 1	=	227.4 ksi
layer 2	=	227.4 ksi
layer 3	=	227.4 ksi
layer 4	=	227.4 ksi
layer 5	=	227.4 ksi
layer 6	=	227.4 ksi
layer 7	=	227.4 ksi
layer 8	=	227.4 ksi
layer 9	=	227.4 ksi
layer 10	=	227.4 ksi
layer 11	=	227.4 ksi
layer 12	=	227.4 ksi
layer 13	=	227.4 ksi
layer 14	=	227.4 ksi

prestress force per strand before any losses:

layer 1	=	19.3 kips
layer 2	=	19.3 kips
layer 3	=	19.3 kips
layer 4	=	19.3 kips
layer 5	=	19.3 kips
layer 6	=	19.3 kips
layer 7	=	19.3 kips
layer 8	=	19.3 kips
layer 9	=	19.3 kips
layer 10	=	19.3 kips
layer 11	=	19.3 kips
layer 12	=	19.3 kips
layer 13	=	19.3 kips
layer 14	=	19.3 kips
Harp Angle	$\psi =$	7.2 °

Hold-down force/strand

layer 1	=	2.5 kips/strand
layer 2	=	2.5 kips/strand
layer 3	=	2.5 kips/strand
layer 4	=	2.5 kips/strand
layer 5	=	2.5 kips/strand
layer 6	=	2.5 kips/strand
layer 7	=	2.5 kips/strand
layer 8	=	2.5 kips/strand
layer 9	=	2.5 kips/strand
layer 10	=	2.5 kips/strand
layer 11	=	2.5 kips/strand
layer 12	=	2.5 kips/strand
layer 13	=	2.5 kips/strand
layer 14	=	2.5 kips/strand
Total hold-down force	=	30.45 kips

### Stresses at Service Loads

#### STRESS LIMITS FOR CONCRETE

##### Compression:

Due to permanent loads for load combination Service I

for the precast beam	=	3.150 ksi
for deck	=	1.800 ksi

Due to permanent and transient loads for load combination Service I

for the precast beam	=	4.200 ksi
for deck	=	2.400 ksi

##### Tension:

Load Combination Service III

for the precast beam	=	-0.016 ksi
----------------------	---	------------

#### STRESSES AT MIDSPAN

Compression stresses at top fiber of beam	at midspan	at endspan		
$f_i = \frac{P_{ps}}{A} - \frac{P_{ps}e}{S_i} + \frac{(M_D + M_{12})}{S_i} + \frac{(M_{ms} + M_s)}{S_{ps}}$				
Due to permanent loads	$f_{i0} =$	2.105 ksi	2.102 ksi	OK
$f_{is} = \frac{P_{ps}}{A} - \frac{P_{ps}e}{S_i} + \frac{(M_D + M_{12})}{S_i} + \frac{(M_{ms} + M_s)}{S_{ps}} + \frac{(M_{LL1})}{S_{ps}}$				
Due to permanent loads and transient loads	$f_{i0} =$	2.508 ksi	2.505 ksi	OK
Compression stresses at top fiber of deck	at midspan	at endspan		
$f_{tr} = \frac{(M_{ms} + M_s)}{S_{tr}}$				
Due to permanent loads	$f_{tr} =$	0.042 ksi	0.042 ksi	OK
$f_{tr} = \frac{(M_{ms} + M_s + M_{LL1})}{S_{tr}}$				
Due to permanent loads and transient loads	$f_{tr} =$	0.488 ksi	0.488 ksi	OK
Tension stresses at top fiber of deck	at midspan	at endspan		
$f_{tr} = \frac{P_{ps}}{A} + \frac{P_{ps}e}{S_i} - \frac{(M_D + M_{12})}{S_i} - \frac{(M_{ms} + M_s + 0.8 * M_{LL1})}{S_{tr}}$				
Load Combination Service III	$f_{t0} =$	-0.792 ksi	-0.781 ksi	OK

### Strength Limit State

#### POSITIVE MOMENT SECTION

$M_u = 1.25DC + 1.5DW + 1.75(LL+IM)$	$M_u =$	8381.5 ft-kips
--------------------------------------	---------	----------------

effective length factor for compression members

layer 1	k =	0.27
layer 2	k =	0.27
layer 3	k =	0.27
layer 4	k =	0.27
layer 5	k =	0.27
layer 6	k =	0.27
layer 7	k =	0.27
layer 8	k =	0.27
layer 9	k =	0.27
layer 10	k =	0.27
layer 11	k =	0.27
layer 12	k =	0.27
layer 13	k =	0.27
layer 14	k =	0.27
	c =	4.6 ft-kips



average stress in prestressing steel

layer 1	$f_{ps} =$	279.4 ksi
layer 2	$f_{ps} =$	279.4 ksi
layer 3	$f_{ps} =$	279.4 ksi
layer 4	$f_{ps} =$	279.4 ksi
layer 5	$f_{ps} =$	279.4 ksi
layer 6	$f_{ps} =$	279.4 ksi
layer 7	$f_{ps} =$	279.4 ksi
layer 8	$f_{ps} =$	279.4 ksi
layer 9	$f_{ps} =$	279.4 ksi
layer 10	$f_{ps} =$	279.4 ksi
layer 11	$f_{ps} =$	279.4 ksi
layer 12	$f_{ps} =$	279.4 ksi
layer 13	$f_{ps} =$	279.4 ksi
layer 14	$f_{ps} =$	279.4 ksi

nominal flexure resistance

	$a =$	3.92 in	
$M_r = \Phi M_n, \Phi = 1.00$	$\Phi M_n =$	9196.5 ft-kips	OK
<b>NEGATIVE MOMENT SECTION</b>			
$M_u = 1.25DC+1.5DW+1.75(LL+IM)$	$M_u =$	-4837.2 ft-kips	
	$a =$	0.20 in	
	$\Phi M_n =$	5099.1 ft-kips	OK

### Shear Design

<b>CRITICAL SECTION AT 0.59</b>			
$V_u = 1.25DC+1.5DW+1.75(LL+IM)$	$V_u =$	405.0 kips	
$M_u = 1.25DC+1.5DW+1.75(LL+IM)$	$M_u =$	-2684.4 ft-kips	
or			
$V_u = 1.25DC+1.5DW+1.75(LL+IM)$	$V_u =$	364.8 kips	
$M_u = 1.25DC+1.5DW+1.75(LL+IM)$	$M_u =$	-2877.0 ft-kips	
max shear	$V_u =$	405.0 kips	
max moment	$M_u =$	2877.0 ft-kips	
Shear depth	$d_v =$	73.19 in	
Applied factored normal force at the section	$N_u =$	0	
Angle of diagonal compressive stresses	$\theta =$	36.00 °	

### STRAIN IN FLEXURAL TENSION REINFORCEMENT

$$\epsilon_s = \frac{\frac{M_u}{d_r} + \eta N_u + 0.5 V_u \cot \theta - A_{ps} f_{ps}}{E_s A_s + E_p A_{ps}} \leq 0.002$$

		at midspan	at endspan
resultant compressive stress at centroid	$f_{pc} =$	0.909 ksi	0.911 ksi

effective stress in prestressing strand after all losses

layer 1	$f_{po} =$	176.7 ksi	177.3 ksi
layer 2	$f_{po} =$	176.7 ksi	177.3 ksi
layer 3	$f_{po} =$	176.7 ksi	177.3 ksi
layer 4	$f_{po} =$	176.7 ksi	177.3 ksi
layer 5	$f_{po} =$	176.7 ksi	
layer 6	$f_{po} =$	176.7 ksi	
layer 7	$f_{po} =$	176.7 ksi	
layer 8	$f_{po} =$	176.7 ksi	
layer 9	$f_{po} =$		177.3 ksi
layer 10	$f_{po} =$		177.3 ksi
layer 11	$f_{po} =$		177.3 ksi
layer 12	$f_{po} =$		177.3 ksi
layer 13	$f_{po} =$		177.3 ksi
layer 14	$f_{po} =$		177.3 ksi

strain in flexural tension

		at midspan	at endspan
layer 1	$\epsilon_x =$	0.002000	0.002000
layer 2	$\epsilon_x =$	0.002000	0.002000
layer 3	$\epsilon_x =$	0.002000	0.002000
layer 4	$\epsilon_x =$	0.002000	0.002000
layer 5	$\epsilon_x =$	0.002000	
layer 6	$\epsilon_x =$	0.002000	
layer 7	$\epsilon_x =$	0.002000	
layer 8	$\epsilon_x =$	0.002000	
layer 9	$\epsilon_x =$		0.002000
layer 10	$\epsilon_x =$		0.002000
layer 11	$\epsilon_x =$		0.002000
layer 12	$\epsilon_x =$		0.002000
layer 13	$\epsilon_x =$		0.002000
layer 14	$\epsilon_x =$		0.002000

### Deflection and Camber

Deflection due to Prestressing Force at Transfer  
 Deflection due to Beam Self-Weight at Transfer  
 Deflection due to Beam Self-Weight at Erection  
 Deflection due to Haunch and Deck

		at midspan	at endspan
$\Delta_p =$		3.27 in	3.29 in
$\Delta_g =$		-1.49 in	
$\Delta_g =$		-1.44 in	
$\Delta_s =$		-1.95 in	

Deflection due to total self weight

$\Delta_{sw} =$		-0.11 in	
-----------------	--	----------	--

Total Deflection at transfer

$\Delta =$		1.79 in	1.81 in
Total Deflection at erection		3.24 in	3.27 in

Live load deflection limit = span/800

$=$		1.80 in	
-----	--	---------	--

Deflection due to live load and impact

$\Delta_L =$		-0.83 in	
--------------	--	----------	--

OK

Deflection due to fire truck

$\Delta_L =$		-0.7520 in	
--------------	--	------------	--

OK

Total Deflection after fire with fire truck

$\Delta =$		2.4129 in	
------------	--	-----------	--

**Parametric Design: US Route 7 Case Study**  
**Beam Design: 3/8" Strand**  
**Fire Exposure Status: Damaged**

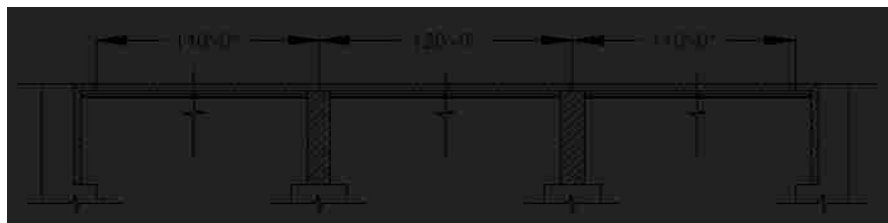
(PCI Bridge Design Manual Section 9.6)



**Material Properties**

CAST-IN-PLACE SLAB			
Actual Thickness	$t_{as} =$		8.0 in
Wearing Surface	$=$		0.5 in
Structural thickness = Actual - Wearing Surface	$t_s =$		7.5 in
Compressive Strength	$f'_c =$		3.09 ksi
Unit Weight	$w_c =$		150.0 pcf
Stress factor of compression block	$\beta_1 =$		0.85

BEAMS: AASHTO-PCI, BT-72 BULB-TEE			
Strength at release	$f_{ci} =$		5.5 ksi
Strength at 28 days	$f'_c =$		7 ksi
Unit Weight	$w_c =$		150.0 pcf
Overall Beam Length:			
@ end spans	$L =$		110 ft
@ center span	$L =$		119 ft
Design Spans:			
Non-composite beam @ end spans	$L =$		109 ft
Non-composite beam @ center span	$L =$		118 ft
Composite beam @ end spans	$L =$		110 ft
Composite beam @ center span	$L =$		120 ft
Beam Spacing	$S =$		12 ft



**PRESTRESSING STRANDS**

Diameter of single strand	d =	0.4 in
Area of single strand	A =	0.085 in <sup>2</sup>
Temperature of Layer		
	layer 1 (bottom)	T = 68.00 °F
	layer 2	T = 68.00 °F
	layer 3	T = 68.00 °F
	layer 4	T = 68.00 °F
	layer 5	T = 68.00 °F
	layer 6	T = 68.00 °F
	layer 7	T = 68.00 °F
	layer 8	T = 68.00 °F
	layer 9	T = 68.00 °F
	layer 10	T = 68.00 °F
	layer 11	T = 68.00 °F
	layer 12	T = 68.00 °F
	layer 13	T = 68.00 °F
	layer 14	T = 68.00 °F
Ultimate Strength		
initial = 284 ksi	layer 1 (bottom)	f <sub>pu</sub> = 284 ksi
	layer 2	f <sub>pu</sub> = 284 ksi
	layer 3	f <sub>pu</sub> = 284 ksi
	layer 4	f <sub>pu</sub> = 284 ksi
	layer 5	f <sub>pu</sub> = 284 ksi
	layer 6	f <sub>pu</sub> = 284 ksi
	layer 7	f <sub>pu</sub> = 284 ksi
	layer 8	f <sub>pu</sub> = 284 ksi
	layer 9	f <sub>pu</sub> = 284 ksi
	layer 10	f <sub>pu</sub> = 284 ksi
	layer 11	f <sub>pu</sub> = 284 ksi
	layer 12	f <sub>pu</sub> = 284 ksi
	layer 13	f <sub>pu</sub> = 284 ksi
	layer 14	f <sub>pu</sub> = 284 ksi
Yield Strength		
initial = 257 ksi	layer 1 (bottom)	f <sub>py</sub> = 257 ksi
	layer 2	f <sub>py</sub> = 257 ksi
	layer 3	f <sub>py</sub> = 257 ksi
	layer 4	f <sub>py</sub> = 257 ksi
	layer 5	f <sub>py</sub> = 257 ksi
	layer 6	f <sub>py</sub> = 257 ksi
	layer 7	f <sub>py</sub> = 257 ksi
	layer 8	f <sub>py</sub> = 257 ksi
	layer 9	f <sub>py</sub> = 257 ksi
	layer 10	f <sub>py</sub> = 257 ksi
	layer 11	f <sub>py</sub> = 257 ksi
	layer 12	f <sub>py</sub> = 257 ksi
	layer 13	f <sub>py</sub> = 257 ksi
	layer 14	f <sub>py</sub> = 257 ksi
<b>Stress Limits:</b>		
before transfer ≤ 0.75f <sub>pu</sub> (initial = 213.2)	layer 1 (bottom)	f <sub>pi</sub> = 213.2 ksi
	layer 2	f <sub>pi</sub> = 213.2 ksi
	layer 3	f <sub>pi</sub> = 213.2 ksi
	layer 4	f <sub>pi</sub> = 213.2 ksi
	layer 5	f <sub>pi</sub> = 213.2 ksi
	layer 6	f <sub>pi</sub> = 213.2 ksi
	layer 7	f <sub>pi</sub> = 213.2 ksi
	layer 8	f <sub>pi</sub> = 213.2 ksi
	layer 9	f <sub>pi</sub> = 213.2 ksi
	layer 10	f <sub>pi</sub> = 213.2 ksi
	layer 11	f <sub>pi</sub> = 213.2 ksi
	layer 12	f <sub>pi</sub> = 213.2 ksi
	layer 13	f <sub>pi</sub> = 213.2 ksi
	layer 14	f <sub>pi</sub> = 213.2 ksi

at service limit state (after all losses)  $\leq 0.80f_{py}$  (initial = 205.4)

layer 1 (bottom)	$f_{pe} =$	205.4 ksi
layer 2	$f_{pe} =$	205.4 ksi
layer 3	$f_{pe} =$	205.4 ksi
layer 4	$f_{pe} =$	205.4 ksi
layer 5	$f_{pe} =$	205.4 ksi
layer 6	$f_{pe} =$	205.4 ksi
layer 7	$f_{pe} =$	205.4 ksi
layer 8	$f_{pe} =$	205.4 ksi
layer 9	$f_{pe} =$	205.4 ksi
layer 10	$f_{pe} =$	205.4 ksi
layer 11	$f_{pe} =$	205.4 ksi
layer 12	$f_{pe} =$	205.4 ksi
layer 13	$f_{pe} =$	205.4 ksi
layer 14	$f_{pe} =$	205.4 ksi

Modulus of Elasticity

initial = 25898 ksi

layer 1 (bottom)	E =	25898.0 ksi
layer 2	E =	25898.0 ksi
layer 3	E =	25898.0 ksi
layer 4	E =	25898.0 ksi
layer 5	E =	25898.0 ksi
layer 6	E =	25898.0 ksi
layer 7	E =	25898.0 ksi
layer 8	E =	25898.0 ksi
layer 9	E =	25898.0 ksi
layer 10	E =	25898.0 ksi
layer 11	E =	25898.0 ksi
layer 12	E =	25898.0 ksi
layer 13	E =	25898.0 ksi
layer 14	E =	25898.0 ksi

### MILD STEEL REINFORCING BARS

Yield Strength

Layer 1 (Bottom)	$f_y =$	60.0 ksi	68.00 °F
Layer 2 (Top)	$f_y =$	51.6 ksi	1193.00 °F

Modulus of Elasticity

Layer 1 (Bottom)	E =	29000.0 ksi
Layer 2 (Top)	E =	29000.0 ksi

Layer 1 (Bottom)

Area of steel at midspan (effective flange)	$A_{sm} =$	2.79 in <sup>2</sup>
Area of steel at endspan (effective flange)	$A_{se} =$	2.48 in <sup>2</sup>
Area of temperature and shrinkage steel (12" width)	$A_{st} =$	0.31 in <sup>2</sup>

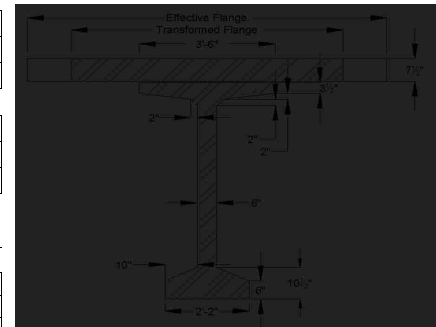
Layer 2 (Top)

Area of steel at midspan (effective flange)	$A_{sm} =$	12.6 in <sup>2</sup>
Area of steel at endspan (effective flange)	$A_{se} =$	12.4 in <sup>2</sup>
Area of temperature and shrinkage steel (12" width)	$A_{st} =$	0.2 in <sup>2</sup>

### Cross-sectional Properties

#### NON-COMPOSITE BEAM

Area of cross-section of beam	A =	767.0 in <sup>2</sup>
Overall depth of beam	H =	72.0 in
Moment of Inertia	I =	539,947 in <sup>4</sup>
Distance from centroid to extreme <u>bottom</u> fiber	$y_b =$	36.6 in
Distance from centroid to extreme <u>top</u> fiber	$y_t =$	35.4 in
Section modulus for the extreme <u>bottom</u> fiber	$S_b =$	14915.0 in <sup>3</sup>
Section modulus for the extreme <u>top</u> fiber	$S_t =$	15421.0 in <sup>3</sup>
Weight	$W_t =$	799.0 plf
Modulus of Elasticity = $33000 \cdot (W_c^{1.5}) \cdot (\sqrt{f'_c})$		
cast-in-place concrete deck	$E_{cs} =$	3370 ksi
precast beam at release	$E_{ci} =$	4496 ksi
precast beam at service loads	$E_c =$	5072 ksi



### COMPOSITE BEAM AT MIDSPAN

Effective Flange Width	$b_f =$	111.0 in	*min of three criteria
Modular Ratio = $E_{cs}/E_c$	$n =$	0.6644	
Transformed flange width	$=$	73.7 in	
Transformed flange area	$=$	553.1 in <sup>2</sup>	
Transformed haunch width	$=$	27.9 in	
Transformed haunch area	$=$	14.0 in <sup>2</sup>	
Deck-distance to top fiber	$y_t =$	4.82 in	

	Transformed Area	$y_b$	$Ay_b$	$A(y_{bc}-y_b)^2$	I	$I + A(y_{bc}-y_b)^2$
Beam	767.0 in <sup>2</sup>	36.60 in	28,072.2 in <sup>3</sup>	205,498 in <sup>4</sup>	539,947 in <sup>4</sup>	745,445 in <sup>4</sup>
Haunch	14.0 in <sup>2</sup>	72.25 in	1,008.1 in <sup>3</sup>	5,187 in <sup>4</sup>	0.29 in <sup>4</sup>	5,188 in <sup>4</sup>
Deck	553.1 in <sup>2</sup>	75.18 in	41,583.1 in <sup>3</sup>	272,881 in <sup>4</sup>	1,499 in <sup>4</sup>	274,380 in <sup>4</sup>
Total	1334.1 in <sup>2</sup>		70,663.4 in <sup>3</sup>			1,025,013 in <sup>4</sup>

Total area of Composite Section	$A_c =$	1334 in <sup>2</sup>
Overall Depth of the Composite Section	$h_c =$	80 in
Moment of Inertia	$I_c =$	1,025,013 in <sup>4</sup>
Distance from centroid to extreme <u>bottom</u> fiber of beam	$y_{bc} =$	52.97 in
Distance from centroid to extreme <u>top</u> fiber of beam	$y_{tg} =$	19.03 in
Distance from centroid to extreme <u>top</u> fiber of slab	$y_{tc} =$	27.03 in
Section modulus for the extreme <u>bottom</u> fiber of beam	$S_{bc} =$	19,351.4 in <sup>3</sup>
Section modulus for the extreme <u>top</u> fiber of beam	$S_{tg} =$	53,858.5 in <sup>3</sup>
Section modulus for the extreme <u>top</u> fiber slab	$S_{tc} =$	57,072.6 in <sup>3</sup>

### COMPOSITE BEAM AT ENDSPAN

Effective Flange Width	$b_f =$	106.6 in	*min of three criteria
Modular Ratio = $E_{cs}/E_c$	$n =$	0.6644	
Transformed flange width	$=$	70.8 in	
Transformed flange area	$=$	531.2 in <sup>2</sup>	
Transformed haunch width	$=$	27.9 in	
Transformed haunch area	$=$	14.0 in <sup>2</sup>	
Deck-distance to top fiber	$y_{td} =$	5.11 in	

	Transformed Area	$y_t$	$Ay_t$	$A(y_{bc}-y_t)^2$	I	$I + A(y_{bc}-y_t)^2$
Beam	767.0 in <sup>2</sup>	36.60 in	28,072.2 in <sup>3</sup>	253,530 in <sup>4</sup>	539,947 in <sup>4</sup>	793,477 in <sup>4</sup>
Haunch	14.0 in <sup>2</sup>	72.25 in	1,008.1 in <sup>3</sup>	4,612 in <sup>4</sup>	0.29 in <sup>4</sup>	4,612 in <sup>4</sup>
Deck	531.2 in <sup>2</sup>	77.61 in	41,225.5 in <sup>3</sup>	175,583 in <sup>4</sup>	1,049 in <sup>4</sup>	176,632 in <sup>4</sup>
Total	1312.1 in <sup>2</sup>		70,305.8 in <sup>3</sup>			974,722 in <sup>4</sup>

Total area of Composite Section	$A_c =$	1312 in <sup>2</sup>
Overall Depth of the Composite Section	$h_c =$	80 in
Moment of Inertia	$I_c =$	974,722 in <sup>4</sup>
Distance from centroid to extreme <u>bottom</u> fiber of beam	$y_{bc} =$	53.58 in
Distance from centroid to extreme <u>top</u> fiber of beam	$y_{tg} =$	18.42 in
Distance from centroid to extreme <u>top</u> fiber of slab	$y_{tc} =$	26.42 in
Section modulus for the extreme <u>bottom</u> fiber of beam	$S_{bc} =$	18,191.6 in <sup>3</sup>
Section modulus for the extreme <u>top</u> fiber of beam	$S_{tg} =$	52,919.3 in <sup>3</sup>
Section modulus for the extreme <u>top</u> fiber slab	$S_{tc} =$	36,894.7 in <sup>3</sup>

### Shear Forces and Bending Moments

#### DEAD LOADS

Beam self-weight	$w_{beam} =$	0.799 k/f
8 in. deck weight	$w_{deck} =$	1.200 k/f
1/2 in. haunch weight	$w_{haunch} =$	0.022 k/f

LRFD Specifications: Art. 4.6.2.2.1

Width of Deck Constant	4	OK
Number of beams is not less than four $N_b =$	1.5	OK
Roadway part of the overhang, $d_b \leq 3.0$ ft, $d_b =$	0	OK
Curvature in plans is less than $4^\circ =$		OK
Cross-section of the bridge is consistent with one of the cross sections given by LRFD specs		OK

Barrier and wearing surface loads are equally distributed among the 4 beams

Barrier Wt	$W_t =$	0.150 k/f
Dead load of future wearing surface	$DW =$	0.263 k/f

LIVE LOADS		
Fire truck live load front load (Point A)	$P_{live} =$	48.0 kips
Fire truck live load back load (Point B)	$P_{live} =$	22.0 kips
distance between two loads		19.2 ft
distance from nearest edge to point A	$x_a =$	59.0 ft
distance from nearest edge to point B	$x_b =$	39.8 ft
LRFD Specifications: Art. 4.6.2.2.1		
Width of Deck Constant		OK
Number of beams is not less than four $N_b =$	4	OK
Beams are parallel and approximately of the same stiffness		OK
Roadway part of the overhang, $d_s \leq 3.0$ ft, $d_o =$	1.5	OK
Curvature in plans is less than $4^\circ =$	0	OK

Barrier and wearing surface loads are equally distributed among the 4 beams

Bridge Type-- "k" (LRFD Table 4.6.2.2.1-1)		
Number of design lanes = $w/12$	=	3 lanes

#### Distribution Factor for Bending Moment:

Beams spacing	$S =$	12.0 ft
Depth of concrete slab	$t_c =$	7.5 in
Beam Span	$L =$	120.0 ft
Number of Beams	$N_b =$	4
Modular ratio between beam & deck materials	$n =$	1.5051
Longitudinal stiffness parameter	$K_g =$	2,627,577.61 in <sup>4</sup>

at center span:		
$DFM = 0.75 + \left(\frac{S}{9.5}\right)^{0.6} + \left(\frac{S}{L}\right)^{0.2} + \left(\frac{K_g}{12 * L * t_c^3}\right)^{0.1}$		
	DFM =	0.915 lanes/beam

0.905 Controls

one design lane loaded:		
$DFM = 0.75 + \left(\frac{S}{14}\right)^{0.4} + \left(\frac{S}{L}\right)^{0.3} + \left(\frac{K_g}{12 * L * t_c^3}\right)^{0.1}$		
	DFM =	0.621 lanes/beam

#### Distribution Factor for Shear Force

both end spans and center span:		
$DFV = 0.2 + \left(\frac{S}{12}\right) - \left(\frac{S}{35}\right)^2$		
	DFV =	1.082 lanes/beam

1.082 Controls

one design lane loaded:		
$DFV = 0.36 + \left(\frac{S}{25}\right)$		
	DFV =	0.840 lanes/beam

from bottom	At Midspan		At Ends	
	No. of	Distance from Bottom	No. of	Distance from Bottom
layer 1	14	2	14	2
layer 2	14	3.5	14	3.5
layer 3	14	5	14	5
layer 4	10	6.5	8	6.5
layer 5	4	8	2	8
layer 6	2	10	-	-
layer 7	2	12	-	-
layer 8	2	14	-	-
layer 9	2	16	2	60
layer 10	-	-	2	62
layer 11	-	-	2	64
layer 12	-	-	2	66
layer 13	-	-	2	68
layer 14	-	-	2	70
	64		64	
<b>Harped Strand Group (included in above totals)</b>				
layer 3	2	6		
layer 4	2	8		
layer 5	2	10		
layer 6	2	12		
layer 7	2	14		
layer 8	2	16		

distance from the center of gravity of strands to the bottom fiber of the beam = 7% of the beam depth  
strand eccentricity at midspan =  $(y_b - y_{bs})$

$y_{bs} =$	5.44 in
$e_c =$	31.16 in

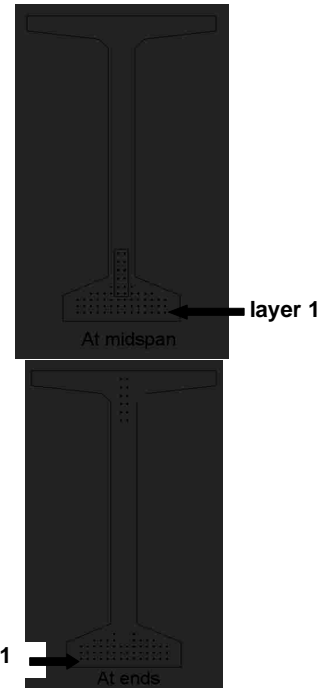
### Prestress Losses

#### ELASTIC SHORTENING

assumed loss	=	6.00%
--------------	---	-------

Force per strand at transfer

layer 1	=	17.0 kips
layer 2	=	17.0 kips
layer 3	=	17.0 kips
layer 4	=	17.0 kips
layer 5	=	17.0 kips
layer 6	=	17.0 kips
layer 7	=	17.0 kips
layer 8	=	17.0 kips
layer 9	=	17.0 kips
layer 10	=	17.0 kips
layer 11	=	17.0 kips
layer 12	=	17.0 kips
layer 13	=	17.0 kips
layer 14	=	17.0 kips



Total prestressing force at release

	at midspan	at endspan
$P_i =$	1088.0 kips	1054.0 kips
$f_{cgp} =$	2.412 ksi	2.307 ksi

Sum of concrete stresses at the center of gravity of prestressing tendons due to prestressing force at transfer and the self-weight of the member at sections of maximum moment

Loss due to shortening

	at midspan	at endspan
layer 1	$\Delta f_{PES} =$ 13.9 ksi	13.3 ksi
layer 2	$\Delta f_{PES} =$ 13.9 ksi	13.3 ksi
layer 3	$\Delta f_{PES} =$ 13.9 ksi	13.3 ksi
layer 4	$\Delta f_{PES} =$ 13.9 ksi	13.3 ksi
layer 5	$\Delta f_{PES} =$ 13.9 ksi	13.3 ksi
layer 6	$\Delta f_{PES} =$ 13.9 ksi	
layer 7	$\Delta f_{PES} =$ 13.9 ksi	
layer 8	$\Delta f_{PES} =$ 13.9 ksi	
layer 9	$\Delta f_{PES} =$ 13.9 ksi	13.3 ksi
layer 10	$\Delta f_{PES} =$	13.3 ksi
layer 11	$\Delta f_{PES} =$	13.3 ksi
layer 12	$\Delta f_{PES} =$	13.3 ksi
layer 13	$\Delta f_{PES} =$	13.3 ksi
layer 14	$\Delta f_{PES} =$	13.3 ksi



SHRINKAGE		
Shrinkage = (17-0.15*Relative Humidity)	$\Delta f_{PSR} =$	6.5 ksi ← assume relative humidity = 70%

CREEP OF CONCRETE			
Change of stresses at center of gravity of prestressing due to permanent loads except the loads acting at time of applying prestressing force, calculated at the same section as $f_{csp}$	$\Delta f_{cdp} =$	1.592 ksi	
		<b>at midspan</b>	<b>at endspan</b>
loss due to creep	$\Delta f_{PCR} =$	17.8 ksi	16.5 ksi

RELAXATION OF PRESTRESSING STRANDS			
loss due to relaxation after transfer		<b>at midspan</b>	<b>at endspan</b>
layer 1	$\Delta f_{pR2} =$	2.9 ksi	2.9 ksi
layer 2	$\Delta f_{pR2} =$	2.9 ksi	2.9 ksi
layer 3	$\Delta f_{pR2} =$	2.9 ksi	2.9 ksi
layer 4	$\Delta f_{pR2} =$	2.9 ksi	2.9 ksi
layer 5	$\Delta f_{pR2} =$	2.9 ksi	2.9 ksi
layer 6	$\Delta f_{pR2} =$	2.9 ksi	
layer 7	$\Delta f_{pR2} =$	2.9 ksi	
layer 8	$\Delta f_{pR2} =$	2.9 ksi	
layer 9	$\Delta f_{pR2} =$	2.9 ksi	2.9 ksi
layer 10	$\Delta f_{pR2} =$		2.9 ksi
layer 11	$\Delta f_{pR2} =$		2.9 ksi
layer 12	$\Delta f_{pR2} =$		2.9 ksi
layer 13	$\Delta f_{pR2} =$		2.9 ksi
layer 14	$\Delta f_{pR2} =$		2.9 ksi

TOTAL LOSSES AT TRANSFER			
total loss $\Delta f_{pES} = \Delta f_{pi}$			
stress in tendons after transfer $f_{pt} = f_{pi} - \Delta f_{pi}$			
		<b>at midspan</b>	<b>at endspan</b>
layer 1	$f_{pt} =$	199.3 ksi	199.9 ksi
layer 2	$f_{pt} =$	199.3 ksi	199.9 ksi
layer 3	$f_{pt} =$	199.3 ksi	199.9 ksi
layer 4	$f_{pt} =$	199.3 ksi	199.9 ksi
layer 5	$f_{pt} =$	199.3 ksi	199.9 ksi
layer 6	$f_{pt} =$	199.3 ksi	
layer 7	$f_{pt} =$	199.3 ksi	
layer 8	$f_{pt} =$	199.3 ksi	
layer 9	$f_{pt} =$	199.3 ksi	199.9 ksi
layer 10	$f_{pt} =$		199.9 ksi
layer 11	$f_{pt} =$		199.9 ksi
layer 12	$f_{pt} =$		199.9 ksi
layer 13	$f_{pt} =$		199.9 ksi
layer 14	$f_{pt} =$		199.9 ksi
force per strand = $f_{pt} \times$ strand area		<b>at midspan</b>	<b>at endspan</b>
layer 1	=	16.9 kips	17.0 kips
layer 2	=	16.9 kips	17.0 kips
layer 3	=	16.9 kips	17.0 kips
layer 4	=	16.9 kips	17.0 kips
layer 5	=	16.9 kips	17.0 kips
layer 6	=	16.9 kips	
layer 7	=	16.9 kips	
layer 8	=	16.9 kips	
layer 9	=	16.9 kips	17.0 kips
layer 10	=		17.0 kips
layer 11	=		17.0 kips
layer 12	=		17.0 kips
layer 13	=		17.0 kips
layer 14	=		17.0 kips
Total prestressing force after transfer	$P_i =$	1047.8 kips	1054.0 kips

Initial loss =  $(\Delta f_{pi}) / (f_{pi})$

		at midspan	at endspan	
layer 1	% =	6.5%	6.2%	OK
layer 2	% =	6.5%	6.2%	OK
layer 3	% =	6.5%	6.2%	OK
layer 4	% =	6.5%	6.2%	OK
layer 5	% =	6.5%	6.2%	OK
layer 6	% =	6.5%		OK
layer 7	% =	6.5%		OK
layer 8	% =	6.5%		OK
layer 9	% =	6.5%	6.2%	OK
layer 10	% =		6.2%	OK
layer 11	% =		6.2%	OK
layer 12	% =		6.2%	OK
layer 13	% =		6.2%	OK
layer 14	% =		6.2%	OK

**TOTAL LOSSES AT SERVICE LOADS**

Total Losses		at midspan	at endspan
layer 1	$\Delta f_{pT} =$	41.1 ksi	40.5 ksi
layer 2	$\Delta f_{pT} =$	41.1 ksi	40.5 ksi
layer 3	$\Delta f_{pT} =$	41.1 ksi	40.5 ksi
layer 4	$\Delta f_{pT} =$	41.1 ksi	40.5 ksi
layer 5	$\Delta f_{pT} =$	41.1 ksi	40.5 ksi
layer 6	$\Delta f_{pT} =$	41.1 ksi	
layer 7	$\Delta f_{pT} =$	41.1 ksi	
layer 8	$\Delta f_{pT} =$	41.1 ksi	
layer 9	$\Delta f_{pT} =$	41.1 ksi	40.5 ksi
layer 10	$\Delta f_{pT} =$		40.5 ksi
layer 11	$\Delta f_{pT} =$		40.5 ksi
layer 12	$\Delta f_{pT} =$		40.5 ksi
layer 13	$\Delta f_{pT} =$		40.5 ksi
layer 14	$\Delta f_{pT} =$		40.5 ksi

Stress in tendon after all losses =  $f_{pi} - \Delta f_{pi}$

		at midspan	at endspan
layer 1	$f_{pe} =$	172.1 ksi	172.7 ksi
layer 2	$f_{pe} =$	172.1 ksi	172.7 ksi
layer 3	$f_{pe} =$	172.1 ksi	172.7 ksi
layer 4	$f_{pe} =$	172.1 ksi	172.7 ksi
layer 5	$f_{pe} =$	172.1 ksi	172.7 ksi
layer 6	$f_{pe} =$	172.1 ksi	
layer 7	$f_{pe} =$	172.1 ksi	
layer 8	$f_{pe} =$	172.1 ksi	
layer 9	$f_{pe} =$	172.1 ksi	172.7 ksi
layer 10	$f_{pe} =$		172.7 ksi
layer 11	$f_{pe} =$		172.7 ksi
layer 12	$f_{pe} =$		172.7 ksi
layer 13	$f_{pe} =$		172.7 ksi
layer 14	$f_{pe} =$		172.7 ksi

check prestressing stress limit at service limit state:  $f_{pe} \leq 0.8 \cdot f_{py}$

layer 1	=	205.4 ksi	OK
layer 2	=	205.4 ksi	OK
layer 3	=	205.4 ksi	OK
layer 4	=	205.4 ksi	OK
layer 5	=	205.4 ksi	OK
layer 6	=	205.4 ksi	OK
layer 7	=	205.4 ksi	OK
layer 8	=	205.4 ksi	OK
layer 9	=	205.4 ksi	OK
layer 10	=	205.4 ksi	OK
layer 11	=	205.4 ksi	OK
layer 12	=	205.4 ksi	OK
layer 13	=	205.4 ksi	OK
layer 14	=	205.4 ksi	OK

force per strand =  $f_{pe}$  \* strand area

		at midspan	at endspan
layer 1	=	14.6 kips	14.7 kips
layer 2	=	14.6 kips	14.7 kips
layer 3	=	14.6 kips	14.7 kips
layer 4	=	14.6 kips	14.7 kips
layer 5	=	14.6 kips	14.7 kips
layer 6	=	14.6 kips	
layer 7	=	14.6 kips	
layer 8	=	14.6 kips	
layer 9	=	14.6 kips	14.7 kips
layer 10	=		14.7 kips
layer 11	=		14.7 kips
layer 12	=		14.7 kips
layer 13	=		14.7 kips
layer 14	=		14.7 kips

Total prestressing force after all losses  $P_{pe} =$   
 Final losses, % =  $(\Delta f_{PT}) / (f_{pi})$

		at midspan	at endspan
$P_{pe} =$		936.1 kips	939.4 kips
layer 1	% =	19.3%	19.0%
layer 2	% =	19.3%	19.0%
layer 3	% =	19.3%	19.0%
layer 4	% =	19.3%	19.0%
layer 5	% =	19.3%	19.0%
layer 6	% =	19.3%	
layer 7	% =	19.3%	
layer 8	% =	19.3%	
layer 9	% =	19.3%	19.0%
layer 10	% =		19.0%
layer 11	% =		19.0%
layer 12	% =		19.0%
layer 13	% =		19.0%
layer 14	% =		19.0%
Average final losses, %	% =	19.3%	19.0%

### Stresses at Transfer

#### STRESS LIMITS FOR CONCRETE

Compression = $0.6f_{ci}$	$f_{ci} =$	3.300 ksi
Tension		
without bonded reinforcement = $-0.0948 \sqrt{f_{ci}} \leq -0.2$	$=$	-0.200 ksi
with bonded auxiliary reinforcement = $-0.22 \sqrt{f_{ci}}$	$=$	-0.016 ksi

#### STRESSES AT TRANSFER LENGTH SECTION

Transfer Length = $60 \times (\text{strand diameter})$	$=$	1.9 ft
Bending moment at transfer length	$M_g =$	87.7 ft-kips
center of 12 strands to top fiber of beam at the end	$=$	7.00 in
center of 12 strands to bottom fiber of beam at the harp point	$=$	11.00 in
center of 12 strands and top fiber of beam at transfer length	$=$	9.84 in
center of gravity of 32 strands and bottom fiber of beam	$=$	3.98 in
center of gravity of all strands and the bottom fiber of beam at transfer length	$=$	15.24 in
center of gravity of all strands and the bottom fiber of beam at the end	$=$	15.30 in
Eccentricity of the strand group at transfer length:	$e_h =$	21.36 in
Eccentricity at end of beam:	$e =$	21.30 in

Calcs for eccentricity (see 9.6.7.2)

$$f_t = \frac{P_1}{A} - \frac{P_1 e}{S_t} + \frac{M_g}{S_t}$$

$$f_b = \frac{P_1}{A} + \frac{P_1 e}{S_b} - \frac{M_g}{S_b}$$

		at midspan	at endspan
Top stress at top fiber of beam	$f_t =$	-0.017 ksi	-0.017 ksi
Bottom stress at bottom fiber of the beam	$f_b =$	2.906 ksi	2.906 ksi

OK  
OK

STRESSES AT HARP POINT			
Bending moment due to beam weight at 0.3L	$M_g =$	1188.0 ft-kips	
Top stress at top fiber of beam	$f_t =$	0.173 ksi	0.169 ksi
Bottom stress at bottom fiber of the beam	$f_b =$	2.736 ksi	2.621 ksi

OK  
OK

STRESSES AT MIDSPAN			
Bending moment due to beam weight at 0.5L	$M_g =$	1414.3 ft-kips	
Top stress at top fiber of beam	$f_t =$	0.320 ksi	0.345 ksi
Bottom stress at bottom fiber of the beam	$f_b =$	2.554 ksi	2.438 ksi

OK  
OK

#### HOLD-DOWN FORCES

assume stress in strand before losses =  $0.8f_u$

layer 1	=	227.4 ksi
layer 2	=	227.4 ksi
layer 3	=	227.4 ksi
layer 4	=	227.4 ksi
layer 5	=	227.4 ksi
layer 6	=	227.4 ksi
layer 7	=	227.4 ksi
layer 8	=	227.4 ksi
layer 9	=	227.4 ksi
layer 10	=	227.4 ksi
layer 11	=	227.4 ksi
layer 12	=	227.4 ksi
layer 13	=	227.4 ksi
layer 14	=	227.4 ksi

prestress force per strand before any losses:

layer 1	=	19.3 kips
layer 2	=	19.3 kips
layer 3	=	19.3 kips
layer 4	=	19.3 kips
layer 5	=	19.3 kips
layer 6	=	19.3 kips
layer 7	=	19.3 kips
layer 8	=	19.3 kips
layer 9	=	19.3 kips
layer 10	=	19.3 kips
layer 11	=	19.3 kips
layer 12	=	19.3 kips
layer 13	=	19.3 kips
layer 14	=	19.3 kips
Harp Angle	$\psi =$	7.2 °

Hold-down force/strand

layer 1	=	2.5 kips/strand
layer 2	=	2.5 kips/strand
layer 3	=	2.5 kips/strand
layer 4	=	2.5 kips/strand
layer 5	=	2.5 kips/strand
layer 6	=	2.5 kips/strand
layer 7	=	2.5 kips/strand
layer 8	=	2.5 kips/strand
layer 9	=	2.5 kips/strand
layer 10	=	2.5 kips/strand
layer 11	=	2.5 kips/strand
layer 12	=	2.5 kips/strand
layer 13	=	2.5 kips/strand
layer 14	=	2.5 kips/strand
Total hold-down force	=	30.45 kips

### Stresses at Service Loads

#### STRESS LIMITS FOR CONCRETE

##### Compression:

Due to permanent loads for load combination Service I

for the precast beam	=	3.150 ksi
for deck	=	1.391 ksi

Due to permanent and transient loads for load combination Service I

for the precast beam	=	4.200 ksi
for deck	=	1.854 ksi

##### Tension:

Load Combination Service III

for the precast beam	=	-0.016 ksi
----------------------	---	------------

#### STRESSES AT MIDSPAN

Compression stresses at top fiber of beam	at midspan	at endspan		
$f_i = \frac{P_{ps}}{A} - \frac{P_{ps}e}{S_i} + \frac{(M_D + M_{L1})}{S_i} + \frac{(M_{ws} + M_b)}{S_{ps}}$				
Due to permanent loads	$f_{i0} =$	2.111 ksi	2.108 ksi	OK
$f_{is} = \frac{P_{ps}}{A} - \frac{P_{ps}e}{S_i} + \frac{(M_D + M_{L1})}{S_i} + \frac{(M_{ws} + M_b)}{S_{ps}} + \frac{(M_{LL1})}{S_{ps}}$				
Due to permanent loads and transient loads	$f_{i0} =$	2.582 ksi	2.580 ksi	OK
Compression stresses at top fiber of deck	at midspan	at endspan		
$f_{tr} = \frac{(M_{ws} + M_b)}{S_{tr}}$				
Due to permanent loads	$f_{tc} =$	0.042 ksi	0.042 ksi	OK
$f_{ts} = \frac{(M_{ws} + M_b + M_{LL1})}{S_{tr}}$				
Due to permanent loads and transient loads	$f_{tc} =$	0.487 ksi	0.487 ksi	OK
Tension stresses at top fiber of deck	at midspan	at endspan		
$f_{tr} = \frac{P_{ps}}{A} + \frac{P_{ps}e}{S_i} - \frac{(M_D + M_{L1})}{S_i} - \frac{(M_{ws} + M_b + 0.8 * M_{LL1})}{S_{tr}}$				
Load Combination Service III	$f_{t0} =$	-0.828 ksi	-0.816 ksi	OK

### Strength Limit State

#### POSITIVE MOMENT SECTION

$M_u = 1.25DC + 1.5DW + 1.75(LL+IM)$	$M_u =$	8381.5 ft-kips
--------------------------------------	---------	----------------

effective length factor for compression members

layer 1	k =	0.27
layer 2	k =	0.27
layer 3	k =	0.27
layer 4	k =	0.27
layer 5	k =	0.27
layer 6	k =	0.27
layer 7	k =	0.27
layer 8	k =	0.27
layer 9	k =	0.27
layer 10	k =	0.27
layer 11	k =	0.27
layer 12	k =	0.27
layer 13	k =	0.27
layer 14	k =	0.27
	c =	5.9 ft-kips

average stress in prestressing steel

layer 1	$f_{ps} =$	278.0 ksi
layer 2	$f_{ps} =$	278.0 ksi
layer 3	$f_{ps} =$	278.0 ksi
layer 4	$f_{ps} =$	278.0 ksi
layer 5	$f_{ps} =$	278.0 ksi
layer 6	$f_{ps} =$	278.0 ksi
layer 7	$f_{ps} =$	278.0 ksi
layer 8	$f_{ps} =$	278.0 ksi
layer 9	$f_{ps} =$	278.0 ksi
layer 10	$f_{ps} =$	278.0 ksi
layer 11	$f_{ps} =$	278.0 ksi
layer 12	$f_{ps} =$	278.0 ksi
layer 13	$f_{ps} =$	278.0 ksi
layer 14	$f_{ps} =$	278.0 ksi

nominal flexure resistance

$M_r = \Phi M_n, \Phi = 1.00$	$a =$	5.04 in	OK
	$\Phi M_n =$	9080.0 ft-kips	
<b>NEGATIVE MOMENT SECTION</b>			
$M_u = 1.25DC+1.5DW+1.75(LL+IM)$	$M_u =$	-4837.2 ft-kips	NOT OK
	$a =$	0.19 in	
	$\Phi M_n =$	4504.5 ft-kips	

### Shear Design

<b>CRITICAL SECTION AT 0.59</b>			
$V_u = 1.25DC+1.5DW+1.75(LL+IM)$	$V_u =$	405.0 kips	
$M_u = 1.25DC+1.5DW+1.75(LL+IM)$	$M_u =$	-2684.4 ft-kips	
or			
$V_u = 1.25DC+1.5DW+1.75(LL+IM)$	$V_u =$	364.8 kips	
$M_u = 1.25DC+1.5DW+1.75(LL+IM)$	$M_u =$	-2877.0 ft-kips	
max shear	$V_u =$	405.0 kips	
max moment	$M_u =$	2877.0 ft-kips	
Shear depth	$d_v =$	73.19 in	
Applied factored normal force at the section	$N_u =$	0	
Angle of diagonal compressive stresses	$\theta =$	36.00 °	

### STRAIN IN FLEXURAL TENSION REINFORCEMENT

$$\epsilon_s = \frac{\frac{M_u}{d_r} + \eta N_u + 0.5 V_u \cot \theta - A_{ps} f_{ps}}{E_s A_s + E_p A_{ps}} \leq 0.002$$

		at midspan	at endspan
resultant compressive stress at centroid	$f_{pc} =$	0.938 ksi	0.941 ksi

effective stress in prestressing strand after all losses

layer 1	$f_{po} =$	176.9 ksi	177.5 ksi
layer 2	$f_{po} =$	176.9 ksi	177.5 ksi
layer 3	$f_{po} =$	176.9 ksi	177.5 ksi
layer 4	$f_{po} =$	176.9 ksi	177.5 ksi
layer 5	$f_{po} =$	176.9 ksi	
layer 6	$f_{po} =$	176.9 ksi	
layer 7	$f_{po} =$	176.9 ksi	
layer 8	$f_{po} =$	176.9 ksi	
layer 9	$f_{po} =$		177.5 ksi
layer 10	$f_{po} =$		177.5 ksi
layer 11	$f_{po} =$		177.5 ksi
layer 12	$f_{po} =$		177.5 ksi
layer 13	$f_{po} =$		177.5 ksi
layer 14	$f_{po} =$		177.5 ksi

strain in flexural tension

		at midspan	at endspan
layer 1	$\epsilon_x =$	0.002000	0.002000
layer 2	$\epsilon_x =$	0.002000	0.002000
layer 3	$\epsilon_x =$	0.002000	0.002000
layer 4	$\epsilon_x =$	0.002000	0.002000
layer 5	$\epsilon_x =$	0.002000	
layer 6	$\epsilon_x =$	0.002000	
layer 7	$\epsilon_x =$	0.002000	
layer 8	$\epsilon_x =$	0.002000	
layer 9	$\epsilon_x =$		0.002000
layer 10	$\epsilon_x =$		0.002000
layer 11	$\epsilon_x =$		0.002000
layer 12	$\epsilon_x =$		0.002000
layer 13	$\epsilon_x =$		0.002000
layer 14	$\epsilon_x =$		0.002000

### Deflection and Camber

Deflection due to Prestressing Force at Transfer  
 Deflection due to Beam Self-Weight at Transfer  
 Deflection due to Beam Self-Weight at Erection  
 Deflection due to Haunch and Deck

		at midspan	at endspan
$\Delta_p =$		3.27 in	3.29 in
$\Delta_g =$		-1.49 in	
$\Delta_g =$		-1.44 in	
$\Delta_s =$		-1.95 in	

Deflection due to total self weight

$\Delta_{sw} =$		-0.11 in	
-----------------	--	----------	--

Total Deflection at transfer

$\Delta =$		1.79 in	1.81 in
Total Deflection at erection		3.24 in	3.27 in

Live load deflection limit = span/800

$=$		1.80 in	
-----	--	---------	--

Deflection due to live load and impact

$\Delta_L =$		-0.89 in	
--------------	--	----------	--

OK

Deflection due to fire truck

$\Delta_L =$		-0.8003 in	
--------------	--	------------	--

OK

Total Deflection after fire with fire truck

$\Delta =$		2.3645 in	
------------	--	-----------	--

**Parametric Design: Puyallup River Case Study**  
**Beam Design: 1/2" Strand**  
**Fire Exposure Status: Undamaged**

(PCI Bridge Design Manual Section 9.6)

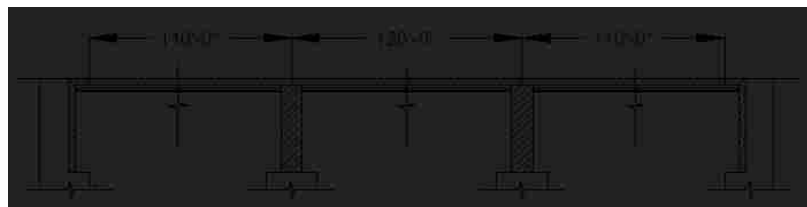


**Material Properties**

CAST-IN-PLACE SLAB		
Actual Thickness	$t_{as} =$	8.0 in
Wearing Surface	$=$	0.5 in
Structural thickness = Actual - Wearing Surface	$t_s =$	7.5 in
Compressive Strength	$f'_c =$	4 ksi
Unit Weight	$w_c =$	150.0 pcf
Stress factor of compression block	$\beta_1 =$	0.85

BEAMS: AASHTO-PCI, BT-72 BULB-TEE		
Strength at release	$f'_{ci} =$	5.5 ksi
Strength at 28 days	$f'_c =$	7 ksi
Unit Weight	$w_c =$	150.0 pcf
Overall Beam Length:		
@ end spans	$L =$	110 ft
@ center span	$L =$	119 ft
Design Spans:		
Non-composite beam @ end spans	$L =$	109 ft
Non-composite beam @ center span	$L =$	118 ft
Composite beam @ end spans	$L =$	110 ft
Composite beam @ center span	$L =$	120 ft
Beam Spacing	$S =$	12 ft





**PRESTRESSING STRANDS**

Diameter of single strand	d =	0.5 in
Area of single strand	A =	0.153 in <sup>2</sup>

Temperature of Layer

layer 1 (bottom)	T =	68.00 °F
layer 2	T =	68.00 °F
layer 3	T =	68.00 °F
layer 4	T =	68.00 °F
layer 5	T =	68.00 °F
layer 6	T =	68.00 °F
layer 7	T =	68.00 °F
layer 8	T =	68.00 °F
layer 9	T =	68.00 °F
layer 10	T =	68.00 °F
layer 11	T =	68.00 °F
layer 12	T =	68.00 °F
layer 13	T =	68.00 °F
layer 14	T =	68.00 °F

Ultimate Strength

initial = 277 ksi

layer 1 (bottom)	f <sub>pu</sub> =	277 ksi
layer 2	f <sub>pu</sub> =	277 ksi
layer 3	f <sub>pu</sub> =	277 ksi
layer 4	f <sub>pu</sub> =	277 ksi
layer 5	f <sub>pu</sub> =	277 ksi
layer 6	f <sub>pu</sub> =	277 ksi
layer 7	f <sub>pu</sub> =	277 ksi
layer 8	f <sub>pu</sub> =	277 ksi
layer 9	f <sub>pu</sub> =	277 ksi
layer 10	f <sub>pu</sub> =	277 ksi
layer 11	f <sub>pu</sub> =	277 ksi
layer 12	f <sub>pu</sub> =	277 ksi
layer 13	f <sub>pu</sub> =	277 ksi
layer 14	f <sub>pu</sub> =	277 ksi

Yield Strength

initial = 250 ksi

layer 1 (bottom)	f <sub>py</sub> =	250 ksi
layer 2	f <sub>py</sub> =	250 ksi
layer 3	f <sub>py</sub> =	250 ksi
layer 4	f <sub>py</sub> =	250 ksi
layer 5	f <sub>py</sub> =	250 ksi
layer 6	f <sub>py</sub> =	250 ksi
layer 7	f <sub>py</sub> =	250 ksi
layer 8	f <sub>py</sub> =	250 ksi
layer 9	f <sub>py</sub> =	250 ksi
layer 10	f <sub>py</sub> =	250 ksi
layer 11	f <sub>py</sub> =	250 ksi
layer 12	f <sub>py</sub> =	250 ksi
layer 13	f <sub>py</sub> =	250 ksi
layer 14	f <sub>py</sub> =	250 ksi

**Stress Limits:**

before transfer ≤ 0.75f<sub>pu</sub> (initial = 202.5)

layer 1 (bottom)	f <sub>pl</sub> =	207.6 ksi
layer 2	f <sub>pl</sub> =	207.6 ksi
layer 3	f <sub>pl</sub> =	207.6 ksi
layer 4	f <sub>pl</sub> =	207.6 ksi
layer 5	f <sub>pl</sub> =	207.6 ksi
layer 6	f <sub>pl</sub> =	207.6 ksi
layer 7	f <sub>pl</sub> =	207.6 ksi
layer 8	f <sub>pl</sub> =	207.6 ksi
layer 9	f <sub>pl</sub> =	207.6 ksi
layer 10	f <sub>pl</sub> =	207.6 ksi
layer 11	f <sub>pl</sub> =	207.6 ksi
layer 12	f <sub>pl</sub> =	207.6 ksi
layer 13	f <sub>pl</sub> =	207.6 ksi
layer 14	f <sub>pl</sub> =	207.6 ksi

at service limit state (after all losses)  $\leq 0.80f_{py}$  (initial = 194.4)

layer 1 (bottom)	$f_{pe} =$	199.7 ksi
layer 2	$f_{pe} =$	199.7 ksi
layer 3	$f_{pe} =$	199.7 ksi
layer 4	$f_{pe} =$	199.7 ksi
layer 5	$f_{pe} =$	199.7 ksi
layer 6	$f_{pe} =$	199.7 ksi
layer 7	$f_{pe} =$	199.7 ksi
layer 8	$f_{pe} =$	199.7 ksi
layer 9	$f_{pe} =$	199.7 ksi
layer 10	$f_{pe} =$	199.7 ksi
layer 11	$f_{pe} =$	199.7 ksi
layer 12	$f_{pe} =$	199.7 ksi
layer 13	$f_{pe} =$	199.7 ksi
layer 14	$f_{pe} =$	199.7 ksi

Modulus of Elasticity

initial = 25982 ksi

layer 1 (bottom)	$E =$	25982.0 ksi
layer 2	$E =$	25982.0 ksi
layer 3	$E =$	25982.0 ksi
layer 4	$E =$	25982.0 ksi
layer 5	$E =$	25982.0 ksi
layer 6	$E =$	25982.0 ksi
layer 7	$E =$	25982.0 ksi
layer 8	$E =$	25982.0 ksi
layer 9	$E =$	25982.0 ksi
layer 10	$E =$	25982.0 ksi
layer 11	$E =$	25982.0 ksi
layer 12	$E =$	25982.0 ksi
layer 13	$E =$	25982.0 ksi
layer 14	$E =$	25982.0 ksi

#### REINFORCING BARS

Yield Strength	$f_y =$	57.6 ksi
Modulus of Elasticity	$E =$	29000.0 ksi

Area of steel at endspan (effective flange)	$A_{se} =$	15.4 in <sup>2</sup>
---	------------	----------------------

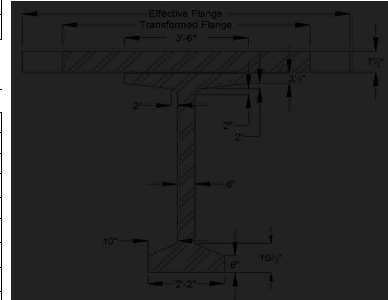
Area of steel at midspan (effective flange)	$A_{sm} =$	0.0 in <sup>2</sup>
---	------------	---------------------

Area of temperature and shrinkage steel (12" width)	$A_s =$	0.0 in <sup>2</sup>
---	---------	---------------------

#### Cross-sectional Properties

##### NON-COMPOSITE BEAM

Area of cross-section of beam	$A =$	767.0 in <sup>2</sup>
Overall depth of beam	$H =$	72.0 in
Moment of Inertia	$I =$	527,217 in <sup>4</sup>
Distance from centroid to extreme <b>bottom</b> fiber	$y_b =$	36.6 in
Distance from centroid to extreme <b>top</b> fiber	$y_t =$	35.4 in
Section modulus for the extreme <b>bottom</b> fiber	$S_b =$	14915.0 in <sup>3</sup>
Section modulus for the extreme <b>top</b> fiber	$S_t =$	15421.0 in <sup>3</sup>
Weight	$W_f =$	799.0 plf
Modulus of Elasticity = $33000 \cdot (W_c \cdot 1.5) \cdot (\sqrt{f_c})$		
cast-in-place concrete deck	$E_{cs} =$	3834 ksi
precast beam at release	$E_{ci} =$	4496 ksi
precast beam at service loads	$E_c =$	5072 ksi



**COMPOSITE BEAM AT MIDSPAN**

Effective Flange Width	$b_f =$	111.0 in	*min of three criteria
Modular Ratio = $E_{cs}/E_c$	$n =$	0.7559	
Transformed flange width	$=$	83.9 in	
Transformed flange area	$=$	629.3 in <sup>2</sup>	
Transformed haunch width	$=$	31.7 in	
Transformed haunch area	$=$	15.9 in <sup>2</sup>	

	Transformed Area	$y_b$	$Ay_b$	$A(y_{bc}-y_b)^2$	I	$I + A(y_{bc}-y_b)^2$
Beam	767.0 in <sup>2</sup>	36.60 in	28,072.2 in <sup>3</sup>	250,443 in <sup>4</sup>	527,217 in <sup>4</sup>	777,660 in <sup>4</sup>
Haunch	15.9 in <sup>2</sup>	72.25 in	1,146.9 in <sup>3</sup>	4,906 in <sup>4</sup>	0.33 in <sup>4</sup>	4,906 in <sup>4</sup>
Deck	629.3 in <sup>2</sup>	76.25 in	47,985.0 in <sup>3</sup>	293,069 in <sup>4</sup>	2,950 in <sup>4</sup>	296,019 in <sup>4</sup>
Total	1412.2 in <sup>2</sup>		77,204.1 in <sup>3</sup>			1,078,585 in <sup>4</sup>

Total area of Composite Section	$A_c =$	1412 in <sup>2</sup>
Overall Depth of the Composite Section	$h_c =$	80 in
Moment of Inertia	$I_c =$	1,078,585 in <sup>4</sup>
Distance from centroid to extreme <u>bottom</u> fiber of beam	$y_{bc} =$	54.67 in
Distance from centroid to extreme <u>top</u> fiber of beam	$y_{tg} =$	17.33 in
Distance from centroid to extreme <u>top</u> fiber of slab	$y_{tc} =$	25.33 in
Section modulus for the extreme <u>bottom</u> fiber of beam	$S_{bc} =$	19,729.0 in <sup>3</sup>
Section modulus for the extreme <u>top</u> fiber of beam	$S_{tg} =$	62,237.8 in <sup>3</sup>
Section modulus for the extreme <u>top</u> fiber slab	$S_{tc} =$	56,329.7 in <sup>3</sup>

**Shear Forces and Bending Moments**

**DEAD LOADS**

Beam self-weight	$w_{beam} =$	0.799 k/f
8 in. deck weight	$w_{deck} =$	1.200 k/f
1/2 in. haunch weight	$w_{haunch} =$	0.022 k/f

LRFD Specifications: Art. 4.6.2.2.1

Width of Deck Constant		OK
Number of beams is not less than four $N_b =$	4	OK
Roadway part of the overhang, $d_o \leq 3.0$ ft, $d_o =$	1.5	OK
Curvature in plans is less than $4^\circ =$	0	OK
Cross-section of the bridge is consistent with one of the cross sections given by LRFD specs		OK

Barrier and wearing surface loads are equally distributed among the 4 beams

Barrier Wt	$Wt =$	0.150 k/f
Dead load of future wearing surface	$DW =$	0.263 k/f

**LIVE LOADS**

Fire truck live load front load (Point A)	$P_{live} =$	48.0 kips
Fire truck live load back load (Point B)	$P_{live} =$	22.0 kips
distance between two loads		19.2 ft
distance from nearest edge to point A	$x_a =$	59.0 ft
distance from nearest edge to point B	$x_b =$	39.8 ft

LRFD Specifications: Art. 4.6.2.2.1

Width of Deck Constant		OK
Number of beams is not less than four $N_b =$	4	OK
Beams are parallel and approximately of the same stiffness		OK
Roadway part of the overhang, $d_o \leq 3.0$ ft, $d_o =$	1.5	OK
Curvature in plans is less than $4^\circ =$	0	OK

Barrier and wearing surface loads are equally distributed among the 4 beams

Bridge Type-- "k" (LRFD Table 4.6.2.2.1-1)		
Number of design lanes = $w/12$	$=$	3 lanes

**Distribution Factor for Bending Moment:**

Beams spacing	S =	12.0 ft
Depth of concrete slab	t <sub>s</sub> =	7.5 in
Beam Span	L =	120.0 ft
Number of Beams	N <sub>b</sub> =	4
Modular ratio between beam & deck materials	n =	1.3229
Longitudinal stiffness parameter	K <sub>g</sub> =	2,292,589.53 in <sup>4</sup>

at center span:

$$DFM = 0.75 + \left(\frac{S}{9.5}\right)^{1.6} * \left(\frac{S}{L}\right)^{0.1} * \left(\frac{K_g}{12 * L * t_s^3}\right)^{0.1}$$

DFM =	0.904 lanes/beam
-------	------------------

one design lane loaded:

$$DFM = 0.75 + \left(\frac{S}{14}\right)^{1.6} * \left(\frac{S}{L}\right)^{0.1} * \left(\frac{K_g}{12 * L * t_s^3}\right)^{0.1}$$

DFM =	0.613 lanes/beam
-------	------------------

0.905 Controls

**Distribution Factor for Shear Force**

both end spans and center span:

$$DFV = 0.2 + \left(\frac{S}{12}\right) - \left(\frac{S}{35}\right)^2$$

DFV =	1.082 lanes/beam
-------	------------------

one design lane loaded:

$$DFV = 0.36 + \left(\frac{S}{25}\right)$$

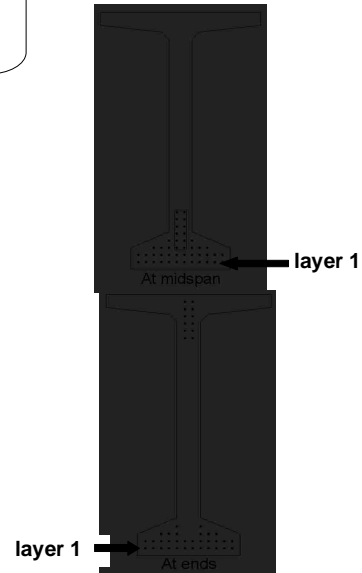
DFV =	0.840 lanes/beam
-------	------------------

1.082 Controls

from bottom	At Midspan		At Ends	
	No. of	Distance from Bottom	No. of	Distance from Bottom
layer 1	12	2	12	2
layer 2	12	4	12	4
layer 3	8	6	6	6
layer 4	4	8	2	8
layer 5	2	10	-	-
layer 6	2	12	-	-
layer 7	2	14	-	-
layer 8	2	16	-	-
layer 9	-	-	2	60
layer 10	-	-	2	62
layer 11	-	-	2	64
layer 12	-	-	2	66
layer 13	-	-	2	68
layer 14	-	-	2	70
<b>Harped Strand Group (included in above totals)</b>				
layer 3	2	6		
layer 4	2	8		
layer 5	2	10		
layer 6	2	12		
layer 7	2	14		
layer 8	2	16		

distance from the center of gravity of strands to the bottom fiber of the beam = 7% of the beam depth  
strand eccentricity at midspan = (y<sub>c</sub> - y<sub>bs</sub>)

y <sub>bs</sub> =	5.82 in
e <sub>c</sub> =	30.78 in



## Prestress Losses

### ELASTIC SHORTENING

assumed loss	=	9.00%
Force per strand at transfer		
layer 1	=	28.9 kips
layer 2	=	28.9 kips
layer 3	=	28.9 kips
layer 4	=	28.9 kips
layer 5	=	28.9 kips
layer 6	=	28.9 kips
layer 7	=	28.9 kips
layer 8	=	28.9 kips
layer 9	=	28.9 kips
layer 10	=	28.9 kips
layer 11	=	28.9 kips
layer 12	=	28.9 kips
layer 13	=	28.9 kips
layer 14	=	28.9 kips

Total prestressing force at release	$P_1 =$	at midspan 1271.6 kips	at endspan 1271.6 kips
Sum of concrete stresses at the center of gravity of prestressing tendons due to prestressing force at transfer and the self-weight of the member at sections of maximum moment	$f_{cgp} =$	2.969 ksi	2.969 ksi
Loss due to shortening			
		at midspan	at endspan
layer 1	$\Delta f_{pES} =$	17.2 ksi	17.2 ksi
layer 2	$\Delta f_{pES} =$	17.2 ksi	17.2 ksi
layer 3	$\Delta f_{pES} =$	17.2 ksi	17.2 ksi
layer 4	$\Delta f_{pES} =$	17.2 ksi	17.2 ksi
layer 5	$\Delta f_{pES} =$	17.2 ksi	
layer 6	$\Delta f_{pES} =$	17.2 ksi	
layer 7	$\Delta f_{pES} =$	17.2 ksi	
layer 8	$\Delta f_{pES} =$	17.2 ksi	
layer 9	$\Delta f_{pES} =$		17.2 ksi
layer 10	$\Delta f_{pES} =$		17.2 ksi
layer 11	$\Delta f_{pES} =$		17.2 ksi
layer 12	$\Delta f_{pES} =$		17.2 ksi
layer 13	$\Delta f_{pES} =$		17.2 ksi
layer 14	$\Delta f_{pES} =$		17.2 ksi

### SHRINKAGE

Shrinkage = $(17-0.15 \cdot \text{Relative Humidity})$	$\Delta f_{pSR} =$	6.5 ksi	← assume relative humidity = 70%
--	--------------------	---------	----------------------------------

### CREEP OF CONCRETE

Change of stresses at center of gravity of prestressing due to permanent loads except the loads acting at time of applying prestressing force, calculated at the same section as $f_{cgp}$	$\Delta f_{cgp} =$	1.599 ksi	
loss due to creep	$\Delta f_{pCR} =$	at midspan 24.4 ksi	at endspan 24.4 ksi

### RELAXATION OF PRESTRESSING STRANDS

loss due to relaxation after transfer			
		at midspan	at endspan
layer 1	$\Delta f_{pR2} =$	2.1 ksi	2.1 ksi
layer 2	$\Delta f_{pR2} =$	2.1 ksi	2.1 ksi
layer 3	$\Delta f_{pR2} =$	2.1 ksi	2.1 ksi
layer 4	$\Delta f_{pR2} =$	2.1 ksi	2.1 ksi
layer 5	$\Delta f_{pR2} =$	2.1 ksi	
layer 6	$\Delta f_{pR2} =$	2.1 ksi	
layer 7	$\Delta f_{pR2} =$	2.1 ksi	
layer 8	$\Delta f_{pR2} =$	2.1 ksi	
layer 9	$\Delta f_{pR2} =$		2.1 ksi
layer 10	$\Delta f_{pR2} =$		2.1 ksi
layer 11	$\Delta f_{pR2} =$		2.1 ksi
layer 12	$\Delta f_{pR2} =$		2.1 ksi
layer 13	$\Delta f_{pR2} =$		2.1 ksi
layer 14	$\Delta f_{pR2} =$		2.1 ksi

**TOTAL LOSSES AT TRANSFER**

total loss  $\Delta f_{pES} = \Delta f_{pi}$

stress in tendons after transfer  $f_{pt} = f_{pi} - \Delta f_{pi}$

		at midspan	at endspan
layer 1	$f_{pt} =$	190.4 ksi	190.4 ksi
layer 2	$f_{pt} =$	190.4 ksi	190.4 ksi
layer 3	$f_{pt} =$	190.4 ksi	190.4 ksi
layer 4	$f_{pt} =$	190.4 ksi	190.4 ksi
layer 5	$f_{pt} =$	190.4 ksi	
layer 6	$f_{pt} =$	190.4 ksi	
layer 7	$f_{pt} =$	190.4 ksi	
layer 8	$f_{pt} =$	190.4 ksi	
layer 9	$f_{pt} =$		190.4 ksi
layer 10	$f_{pt} =$		190.4 ksi
layer 11	$f_{pt} =$		190.4 ksi
layer 12	$f_{pt} =$		190.4 ksi
layer 13	$f_{pt} =$		190.4 ksi
layer 14	$f_{pt} =$		190.4 ksi

force per strand =  $f_{pt}$  \* strand area

		at midspan	at endspan
layer 1	=	29.1 kips	29.1 kips
layer 2	=	29.1 kips	29.1 kips
layer 3	=	29.1 kips	29.1 kips
layer 4	=	29.1 kips	29.1 kips
layer 5	=	29.1 kips	
layer 6	=	29.1 kips	
layer 7	=	29.1 kips	
layer 8	=	29.1 kips	
layer 9	=		29.1 kips
layer 10	=		29.1 kips
layer 11	=		29.1 kips
layer 12	=		29.1 kips
layer 13	=		29.1 kips
layer 14	=		29.1 kips
Total prestressing force after transfer	$P_i =$	1280.4 kips	1280.4 kips

Initial loss =  $(\Delta f_{pi}) / (f_{pi})$

		at midspan	at endspan
layer 1	% =	8.3%	8.3%
layer 2	% =	8.3%	8.3%
layer 3	% =	8.3%	8.3%
layer 4	% =	8.3%	8.3%
layer 5	% =	8.3%	
layer 6	% =	8.3%	
layer 7	% =	8.3%	
layer 8	% =	8.3%	
layer 9	% =		8.3%
layer 10	% =		8.3%
layer 11	% =		8.3%
layer 12	% =		8.3%
layer 13	% =		8.3%
layer 14	% =		8.3%

OK  
OK  
OK  
OK  
OK  
OK  
OK  
OK  
OK  
OK  
OK  
OK  
OK  
OK

**TOTAL LOSSES AT SERVICE LOADS**

Total Losses		at midspan	at endspan
layer 1	$\Delta f_{pT} =$	50.2 ksi	50.2 ksi
layer 2	$\Delta f_{pT} =$	50.2 ksi	50.2 ksi
layer 3	$\Delta f_{pT} =$	50.2 ksi	50.2 ksi
layer 4	$\Delta f_{pT} =$	50.2 ksi	50.2 ksi
layer 5	$\Delta f_{pT} =$	50.2 ksi	
layer 6	$\Delta f_{pT} =$	50.2 ksi	
layer 7	$\Delta f_{pT} =$	50.2 ksi	
layer 8	$\Delta f_{pT} =$	50.2 ksi	
layer 9	$\Delta f_{pT} =$		50.2 ksi
layer 10	$\Delta f_{pT} =$		50.2 ksi
layer 11	$\Delta f_{pT} =$		50.2 ksi
layer 12	$\Delta f_{pT} =$		50.2 ksi
layer 13	$\Delta f_{pT} =$		50.2 ksi
layer 14	$\Delta f_{pT} =$		50.2 ksi

Stress in tendon after all losses =  $f_{pe} \Delta f_{pt}$

		at midspan	at endspan
layer 1	$f_{pe} =$	157.4 ksi	157.4 ksi
layer 2	$f_{pe} =$	157.4 ksi	157.4 ksi
layer 3	$f_{pe} =$	157.4 ksi	157.4 ksi
layer 4	$f_{pe} =$	157.4 ksi	157.4 ksi
layer 5	$f_{pe} =$	157.4 ksi	
layer 6	$f_{pe} =$	157.4 ksi	
layer 7	$f_{pe} =$	157.4 ksi	
layer 8	$f_{pe} =$	157.4 ksi	
layer 9	$f_{pe} =$		157.4 ksi
layer 10	$f_{pe} =$		157.4 ksi
layer 11	$f_{pe} =$		157.4 ksi
layer 12	$f_{pe} =$		157.4 ksi
layer 13	$f_{pe} =$		157.4 ksi
layer 14	$f_{pe} =$		157.4 ksi

check prestressing stress limit at service limit state:  $f_{pe} \leq 0.8 f_{py}$

layer 1	=	199.7 ksi
layer 2	=	199.7 ksi
layer 3	=	199.7 ksi
layer 4	=	199.7 ksi
layer 5	=	199.7 ksi
layer 6	=	199.7 ksi
layer 7	=	199.7 ksi
layer 8	=	199.7 ksi
layer 9	=	199.7 ksi
layer 10	=	199.7 ksi
layer 11	=	199.7 ksi
layer 12	=	199.7 ksi
layer 13	=	199.7 ksi
layer 14	=	199.7 ksi

OK  
OK  
OK  
OK  
OK  
OK  
OK  
OK  
OK  
OK  
OK  
OK  
OK  
OK

force per strand =  $f_{pe} \cdot \text{strand area}$

		at midspan	at endspan
layer 1	=	24.1 kips	24.1 kips
layer 2	=	24.1 kips	24.1 kips
layer 3	=	24.1 kips	24.1 kips
layer 4	=	24.1 kips	24.1 kips
layer 5	=	24.1 kips	
layer 6	=	24.1 kips	
layer 7	=	24.1 kips	
layer 8	=	24.1 kips	
layer 9	=		24.1 kips
layer 10	=		24.1 kips
layer 11	=		24.1 kips
layer 12	=		24.1 kips
layer 13	=		24.1 kips
layer 14	=		24.1 kips

Total prestressing force after all losses

	at midspan	at endspan
$P_{pe} =$	1059.8 kips	1059.8 kips

Final losses, % =  $(\Delta f_{pt}) / (f_{pi})$

layer 1	% =	24.2%	24.2%
layer 2	% =	24.2%	24.2%
layer 3	% =	24.2%	24.2%
layer 4	% =	24.2%	24.2%
layer 5	% =	24.2%	
layer 6	% =	24.2%	
layer 7	% =	24.2%	
layer 8	% =	24.2%	
layer 9	% =		24.2%
layer 10	% =		24.2%
layer 11	% =		24.2%
layer 12	% =		24.2%
layer 13	% =		24.2%
layer 14	% =		24.2%
Average final losses, %	% =	24.2%	24.2%

## Stresses at Transfer

### STRESS LIMITS FOR CONCRETE

Compression = $0.6f_{ci}$	$f_{ci} =$	3.300 ksi
Tension		
without bonded reinforcement = $-0.0948\sqrt{f_{ci}} \leq -0.2$	=	-0.200 ksi
with bonded auxiliary reinforcement = $-0.22\sqrt{f_{ci}}$	=	-0.016 ksi

### STRESSES AT TRANSFER LENGTH SECTION

Transfer Length = $60 \times (\text{strand diameter})$	=	2.5 ft	} Calcs for eccentricity (see 9.6.7.2)
Bending moment at transfer length	$M_g =$	116.4 ft-kips	
center of 12 strands to top fiber of beam at the end	=	7.00 in	
center of 12 strands to bottom fiber of beam at the harp point	=	11.00 in	
center of 12 strands and top fiber of beam at transfer length	=	10.78 in	
center of gravity of 32 strands and bottom fiber of beam	=	3.88 in	
center of gravity of all strands and the bottom fiber of beam at transfer length	=	19.51 in	
center of gravity of all strands and the bottom fiber of beam at the end	=	20.55 in	
Eccentricity of the strand group at transfer length:	$e_h =$	17.09 in	
Eccentricity at end of beam:	$e =$	16.05 in	

$$f_t = \frac{P_i}{A} - \frac{P_i e}{S_t} + \frac{M_g}{S_t}$$

$$f_b = \frac{P_i}{A} + \frac{P_i e}{S_b} - \frac{M_g}{S_b}$$

		at midspan	at endspan	
Top stress at top fiber of beam	$f_t =$	0.341 ksi	0.341 ksi	OK
Bottom stress at bottom fiber of the beam	$f_b =$	3.021 ksi	3.021 ksi	OK

### STRESSES AT HARP POINT

Bending moment due to beam weight at 0.3L	$M_g =$	1188.0 ft-kips	
Top stress at top fiber of beam	$f_t =$	0.038 ksi	0.038 ksi
Bottom stress at bottom fiber of the beam	$f_b =$	3.300 ksi	3.300 ksi

### STRESSES AT MIDSPAN

Bending moment due to beam weight at 0.5L	$M_g =$	1414.3 ft-kips	
Top stress at top fiber of beam	$f_t =$	0.220 ksi	0.214 ksi
Bottom stress at bottom fiber of the beam	$f_b =$	3.144 ksi	3.174 ksi

### HOLD-DOWN FORCES

assume stress in strand before losses =  $0.8f_u$

layer 1	=	221.4 ksi
layer 2	=	221.4 ksi
layer 3	=	221.4 ksi
layer 4	=	221.4 ksi
layer 5	=	221.4 ksi
layer 6	=	221.4 ksi
layer 7	=	221.4 ksi
layer 8	=	221.4 ksi
layer 9	=	221.4 ksi
layer 10	=	221.4 ksi
layer 11	=	221.4 ksi
layer 12	=	221.4 ksi
layer 13	=	221.4 ksi
layer 14	=	221.4 ksi

prestress force per strand before any losses:

layer 1	=	33.9 kips
layer 2	=	33.9 kips
layer 3	=	33.9 kips
layer 4	=	33.9 kips
layer 5	=	33.9 kips
layer 6	=	33.9 kips
layer 7	=	33.9 kips
layer 8	=	33.9 kips
layer 9	=	33.9 kips
layer 10	=	33.9 kips
layer 11	=	33.9 kips
layer 12	=	33.9 kips
layer 13	=	33.9 kips
layer 14	=	33.9 kips
Harp Angle	$\psi =$	7.2 °



Hold-down force/strand

layer 1	=	4.4 kips/strand
layer 2	=	4.4 kips/strand
layer 3	=	4.4 kips/strand
layer 4	=	4.4 kips/strand
layer 5	=	4.4 kips/strand
layer 6	=	4.4 kips/strand
layer 7	=	4.4 kips/strand
layer 8	=	4.4 kips/strand
layer 9	=	4.4 kips/strand
layer 10	=	4.4 kips/strand
layer 11	=	4.4 kips/strand
layer 12	=	4.4 kips/strand
layer 13	=	4.4 kips/strand
layer 14	=	4.4 kips/strand
Total hold-down force	=	53.39 kips

### Stresses at Service Loads

#### STRESS LIMITS FOR CONCRETE

##### Compression:

Due to permanent loads for load combination Service I

for the precast beam	=	3.150 ksi
for deck	=	1.800 ksi

Due to permanent and transient loads for load combination Service I

for the precast beam	=	4.200 ksi
for deck	=	2.400 ksi

##### Tension:

Load Combination Service III

for the precast beam	=	-0.016 ksi
----------------------	---	------------

#### STRESSES AT MIDSPAN

Compression stresses at top fiber of beam	at midspan	at endspan	
$f_t = \frac{P_{ps}}{A} - \frac{P_{ps}e}{S_t} + \frac{(M_D + M_{D1})}{S_t} + \frac{(M_w + M_D)}{S_{tw}}$			
Due to permanent loads	$f_{tg} =$	2.042 ksi	2.042 ksi
$f_{tr} = \frac{P_{ps}}{A} - \frac{P_{ps}e}{S_t} + \frac{(M_D + M_{D1})}{S_t} + \frac{(M_w - M_D)}{S_{tw}} + \frac{(M_{D1+1})}{S_{tw}}$			OK
Due to permanent loads and transient loads	$f_{tg} =$	2.450 ksi	2.450 ksi
<b>Compression stresses at top fiber of deck</b>	<b>at midspan</b>	<b>at endspan</b>	
$f_{tr} = \frac{(M_w + M_D)}{S_{tr}}$			
Due to permanent loads	$f_{tc} =$	0.043 ksi	0.043 ksi
$f_{tr} = \frac{(M_w + M_D + M_{D1+1})}{S_{tr}}$			
Due to permanent loads and transient loads	$f_{tc} =$	0.493 ksi	0.493 ksi
<b>Tension stresses at top fiber of deck</b>	<b>at midspan</b>	<b>at endspan</b>	
$f_{tr} = \frac{P_{ps}}{A} + \frac{P_{ps}e}{S_t} - \frac{(M_D + M_{D1})}{S_t} - \frac{(M_w + M_D + 0.8 * M_{D1+1})}{S_{tr}}$			
Load Combination Service III	$f_b =$	-0.413 ksi	-0.413 ksi
			OK

### Strength Limit State

POSITIVE MOMENT SECTION		
$M_u = 1.25DC+1.5DW+1.75(LL+IM)$	$M_u =$	8381.5 ft-kips
effective length factor for compression members		
layer 1	k =	0.28
layer 2	k =	0.28
layer 3	k =	0.28
layer 4	k =	0.28
layer 5	k =	0.28
layer 6	k =	0.28
layer 7	k =	0.28
layer 8	k =	0.28
layer 9	k =	0.28
layer 10	k =	0.28
layer 11	k =	0.28
layer 12	k =	0.28
layer 13	k =	0.28
layer 14	k =	0.28
	c =	5.7 ft-kips

average stress in prestressing steel

layer 1	$f_{ps} =$	270.9 ksi
layer 2	$f_{ps} =$	270.9 ksi
layer 3	$f_{ps} =$	270.9 ksi
layer 4	$f_{ps} =$	270.9 ksi
layer 5	$f_{ps} =$	270.9 ksi
layer 6	$f_{ps} =$	270.9 ksi
layer 7	$f_{ps} =$	270.9 ksi
layer 8	$f_{ps} =$	270.9 ksi
layer 9	$f_{ps} =$	270.9 ksi
layer 10	$f_{ps} =$	270.9 ksi
layer 11	$f_{ps} =$	270.9 ksi
layer 12	$f_{ps} =$	270.9 ksi
layer 13	$f_{ps} =$	270.9 ksi
layer 14	$f_{ps} =$	270.9 ksi

nominal flexure resistance

	a =	4.87 in	
$M_r = \Phi M_n, \Phi = 1.00$	$\Phi M_n =$	10902.9 ft-kips	OK
M=DC+W+LL+IM	M =	5833.6 ft-kips	OK
NEGATIVE MOMENT SECTION			
$M_u = 1.25DC+1.5DW+1.75(LL+IM)$	$M_u =$	4837.2 ft-kips	
	a =	5.73 in	
	$\Phi M_n =$	4879.0 ft-kips	OK
M=DC+W+LL+IM	M =	2869.7 ft-kips	OK

### Shear Design

CRITICAL SECTION AT 0.59		
$V_u = 1.25DC+1.5DW+1.75(LL+IM)$	$V_u =$	405.0 kips
$M_u = 1.25DC+1.5DW+1.75(LL+IM)$	$M_u =$	-2684.4 ft-kips
or		
$V_u = 1.25DC+1.5DW+1.75(LL+IM)$	$V_u =$	364.8 kips
$M_u = 1.25DC+1.5DW+1.75(LL+IM)$	$M_u =$	-2877.0 ft-kips
max shear	$V_u =$	405.0 kips
max moment	$M_u =$	2877.0 ft-kips
Shear depth	$d_v =$	73.19 in
Applied factored normal force at the section	$N_u =$	0
Angle of diagonal compressive stresses	$\theta =$	36.00 °

### STRAIN IN FLEXURAL TENSION REINFORCEMENT

$\epsilon_t = \frac{\frac{M_u}{d_v} + 0.5N_u + 0.5M_u \cot \theta}{E_s A_s + E_s A_{sp}} \leq 0.002$		
	at midspan	at endspan
resultant compressive stress at centroid	$f_{pc} =$	0.983 ksi

effective stress in prestressing strand after all losses

layer 1	$f_{po} =$	162.5 ksi	162.5 ksi
layer 2	$f_{po} =$	162.5 ksi	162.5 ksi
layer 3	$f_{po} =$	162.5 ksi	162.5 ksi
layer 4	$f_{po} =$	162.5 ksi	162.5 ksi
layer 5	$f_{po} =$	162.5 ksi	
layer 6	$f_{po} =$	162.5 ksi	
layer 7	$f_{po} =$	162.5 ksi	
layer 8	$f_{po} =$	162.5 ksi	
layer 9	$f_{po} =$		162.5 ksi
layer 10	$f_{po} =$		162.5 ksi
layer 11	$f_{po} =$		162.5 ksi
layer 12	$f_{po} =$		162.5 ksi
layer 13	$f_{po} =$		162.5 ksi
layer 14	$f_{po} =$		162.5 ksi

strain in flexural tension

		at midspan	at endspan
layer 1	$\epsilon_x =$	0.002000	0.002000
layer 2	$\epsilon_x =$	0.002000	0.002000
layer 3	$\epsilon_x =$	0.002000	0.002000
layer 4	$\epsilon_x =$	0.002000	0.002000
layer 5	$\epsilon_x =$	0.002000	
layer 6	$\epsilon_x =$	0.002000	
layer 7	$\epsilon_x =$	0.002000	
layer 8	$\epsilon_x =$	0.002000	
layer 9	$\epsilon_x =$		0.002000
layer 10	$\epsilon_x =$		0.002000
layer 11	$\epsilon_x =$		0.002000
layer 12	$\epsilon_x =$		0.002000
layer 13	$\epsilon_x =$		0.002000
layer 14	$\epsilon_x =$		0.002000

### Deflection and Camber

Deflection due to Prestressing Force at Transfer  
 Deflection due to Beam Self-Weight at Transfer  
 Deflection due to Beam Self-Weight at Erection  
 Deflection due to Haunch and Deck

	at midspan	at endspan
$\Delta_p =$	4.05 in	4.05 in
$\Delta_g =$	-1.52 in	
$\Delta_g =$	-1.30 in	
$\Delta_s =$	-1.99 in	

Deflection due to total self weight

$\Delta_{sw} =$	0.75 in
-----------------	---------

Total Deflection at transfer  
 Total Deflection at erection

$\Delta =$	2.53 in	2.53 in
$\Delta =$	4.88 in	4.88 in

Live load deflection limit = span/800  
 Deflection due to live load and impact

$\Delta_L =$	-1.80 in
$\Delta_L =$	-0.80 in

OK

Deflection due to fire truck  
 Total Deflection after fire with fire truck

$\Delta_L =$	-1.4796 in
$\Delta =$	3.3248 in

OK

**Parametric Design: Puyallup River Case Study**  
**Beam Design: 1/2" Strand**  
**Fire Exposure Status: 1 Hour**

(PCI Bridge Design Manual Section 9.6)

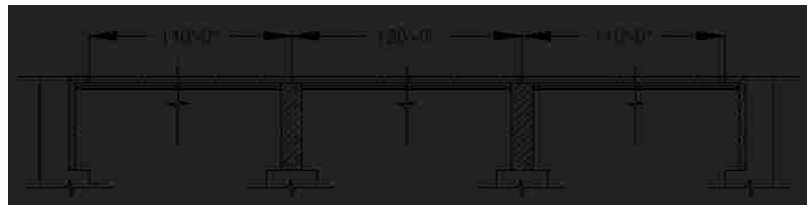


**Material Properties**

CAST-IN-PLACE SLAB		
Actual Thickness	$t_{as} =$	8.0 in
Wearing Surface	$=$	0.5 in
Structural thickness = Actual - Wearing Surface	$t_s =$	7.5 in
Compressive Strength	$f'_c =$	4 ksi
Unit Weight	$w_c =$	150.0 pcf
Stress factor of compression block	$\beta_1 =$	0.85

BEAMS: AASHTO-PCI, BT-72 BULB-TEE		
Strength at release	$f'_{ci} =$	5.5 ksi
Strength at 28 days	$f'_c =$	5.02 ksi
Unit Weight	$w_c =$	150.0 pcf
Overall Beam Length:		
@ end spans	$L =$	110 ft
@ center span	$L =$	119 ft
Design Spans:		
Non-composite beam @ end spans	$L =$	109 ft
Non-composite beam @ center span	$L =$	118 ft
Composite beam @ end spans	$L =$	110 ft
Composite beam @ center span	$L =$	120 ft
Beam Spacing	$S =$	12 ft



**PRESTRESSING STRANDS**

Diameter of single strand	d =	0.5 in
Area of single strand	A =	0.153 in <sup>2</sup>

Temperature of Layer

layer 1 (bottom)	T =	870.00 °F
layer 2	T =	150.00 °F
layer 3	T =	68.00 °F
layer 4	T =	68.00 °F
layer 5	T =	68.00 °F
layer 6	T =	68.00 °F
layer 7	T =	68.00 °F
layer 8	T =	68.00 °F
layer 9	T =	68.00 °F
layer 10	T =	68.00 °F
layer 11	T =	68.00 °F
layer 12	T =	68.00 °F
layer 13	T =	68.00 °F
layer 14	T =	68.00 °F

Ultimate Strength

initial = 277 ksi

layer 1 (bottom)	f <sub>pu</sub> =	219 ksi
layer 2	f <sub>pu</sub> =	274 ksi
layer 3	f <sub>pu</sub> =	277 ksi
layer 4	f <sub>pu</sub> =	277 ksi
layer 5	f <sub>pu</sub> =	277 ksi
layer 6	f <sub>pu</sub> =	277 ksi
layer 7	f <sub>pu</sub> =	277 ksi
layer 8	f <sub>pu</sub> =	277 ksi
layer 9	f <sub>pu</sub> =	277 ksi
layer 10	f <sub>pu</sub> =	277 ksi
layer 11	f <sub>pu</sub> =	277 ksi
layer 12	f <sub>pu</sub> =	277 ksi
layer 13	f <sub>pu</sub> =	277 ksi
layer 14	f <sub>pu</sub> =	277 ksi

Yield Strength

initial = 250 ksi

layer 1 (bottom)	f <sub>py</sub> =	217 ksi
layer 2	f <sub>py</sub> =	247 ksi
layer 3	f <sub>py</sub> =	250 ksi
layer 4	f <sub>py</sub> =	250 ksi
layer 5	f <sub>py</sub> =	250 ksi
layer 6	f <sub>py</sub> =	250 ksi
layer 7	f <sub>py</sub> =	250 ksi
layer 8	f <sub>py</sub> =	250 ksi
layer 9	f <sub>py</sub> =	250 ksi
layer 10	f <sub>py</sub> =	250 ksi
layer 11	f <sub>py</sub> =	250 ksi
layer 12	f <sub>py</sub> =	250 ksi
layer 13	f <sub>py</sub> =	250 ksi
layer 14	f <sub>py</sub> =	250 ksi

**Stress Limits:**

before transfer ≤ 0.75f<sub>pu</sub> (initial = 202.5)

layer 1 (bottom)	f <sub>di</sub> =	164.0 ksi
layer 2	f <sub>di</sub> =	205.5 ksi
layer 3	f <sub>di</sub> =	207.6 ksi
layer 4	f <sub>di</sub> =	207.6 ksi
layer 5	f <sub>di</sub> =	207.6 ksi
layer 6	f <sub>di</sub> =	207.6 ksi
layer 7	f <sub>di</sub> =	207.6 ksi
layer 8	f <sub>di</sub> =	207.6 ksi
layer 9	f <sub>di</sub> =	207.6 ksi
layer 10	f <sub>di</sub> =	207.6 ksi
layer 11	f <sub>di</sub> =	207.6 ksi
layer 12	f <sub>di</sub> =	207.6 ksi
layer 13	f <sub>di</sub> =	207.6 ksi
layer 14	f <sub>di</sub> =	207.6 ksi



**COMPOSITE BEAM AT MIDSPAN**

Effective Flange Width	$b_f =$	111.0 in	*min of three criteria
Modular Ratio = $E_{cs}/E_c$	$n =$	0.8926	
Transformed flange width	$=$	99.1 in	
Transformed flange area	$=$	743.1 in <sup>2</sup>	
Transformed haunch width	$=$	37.5 in	
Transformed haunch area	$=$	18.7 in <sup>2</sup>	

	Transformed Area	$y_b$	$Ay_b$	$A(y_{bc}-y_b)^2$	I	$I + A(y_{bc}-y_b)^2$
Beam	767.0 in <sup>2</sup>	38.50 in	29,529.5 in <sup>3</sup>	270,012 in <sup>4</sup>	411,881 in <sup>4</sup>	681,893 in <sup>4</sup>
Haunch	18.7 in <sup>2</sup>	72.25 in	1,354.4 in <sup>3</sup>	4,211 in <sup>4</sup>	0.33 in <sup>4</sup>	4,211 in <sup>4</sup>
Deck	743.1 in <sup>2</sup>	76.25 in	56,663.3 in <sup>3</sup>	267,912 in <sup>4</sup>	2,950 in <sup>4</sup>	270,861 in <sup>4</sup>
Total	1528.9 in <sup>2</sup>		87,547.2 in <sup>3</sup>			956,966 in <sup>4</sup>

Total area of Composite Section	$A_c =$	1529 in <sup>2</sup>
Overall Depth of the Composite Section	$h_c =$	80 in
Moment of Inertia	$I_c =$	956,966 in <sup>4</sup>
Distance from centroid to extreme <u>bottom</u> fiber of beam	$y_{bc} =$	57.26 in
Distance from centroid to extreme <u>top</u> fiber of beam	$y_{tg} =$	14.74 in
Distance from centroid to extreme <u>top</u> fiber of slab	$y_{tc} =$	22.74 in
Section modulus for the extreme <u>bottom</u> fiber of beam	$S_{bc} =$	16,711.9 in <sup>3</sup>
Section modulus for the extreme <u>top</u> fiber of beam	$S_{tg} =$	64,934.7 in <sup>3</sup>
Section modulus for the extreme <u>top</u> fiber slab	$S_{tc} =$	47,149.6 in <sup>3</sup>

**Shear Forces and Bending Moments**

**DEAD LOADS**

Beam self-weight	$w_{beam} =$	0.799 k/f
8 in. deck weight	$w_{deck} =$	1.200 k/f
1/2 in. haunch weight	$w_{haunch} =$	0.022 k/f

LRFD Specifications: Art. 4.6.2.2.1

Width of Deck Constant		OK
Number of beams is not less than four $N_b =$	4	OK
Roadway part of the overhang, $d_o \leq 3.0$ ft, $d_o =$	1.5	OK
Curvature in plans is less than $4^\circ =$	0	OK
Cross-section of the bridge is consistent with one of the cross sections given by LRFD specs		OK

Barrier and wearing surface loads are equally distributed among the 4 beams

Barrier Wt	$Wt =$	0.150 k/f
Dead load of future wearing surface	$DW =$	0.263 k/f

**LIVE LOADS**

Fire truck live load front load (Point A)	$P_{live} =$	48.0 kips
Fire truck live load back load (Point B)	$P_{live} =$	22.0 kips
distance between two loads		19.2 ft
distance from nearest edge to point A	$x_a =$	59.0 ft
distance from nearest edge to point B	$x_b =$	39.8 ft

LRFD Specifications: Art. 4.6.2.2.1

Width of Deck Constant		OK
Number of beams is not less than four $N_b =$	4	OK
Beams are parallel and approximately of the same stiffness		OK
Roadway part of the overhang, $d_o \leq 3.0$ ft, $d_o =$	1.5	OK
Curvature in plans is less than $4^\circ =$	0	OK

Barrier and wearing surface loads are equally distributed among the 4 beams

Bridge Type-- "k" (LRFD Table 4.6.2.2.1-1)		
Number of design lanes = $w/12$	$=$	3 lanes

**Distribution Factor for Bending Moment:**

Beams spacing	S =	12.0 ft
Depth of concrete slab	t <sub>s</sub> =	7.5 in
Beam Span	L =	120.0 ft
Number of Beams	N <sub>b</sub> =	4
Modular ratio between beam & deck materials	n =	1.1203
Longitudinal stiffness parameter	K <sub>g</sub> =	1,812,256.42 in <sup>4</sup>

at center span:

$$DFM = 0.75 + \left(\frac{S}{9.5}\right)^{1.6} * \left(\frac{S}{L}\right)^{0.1} * \left(\frac{K_g}{12 * L * t_s^3}\right)^{0.1}$$

DFM =	0.885 lanes/beam
-------	------------------

one design lane loaded:

$$DFM = 0.75 + \left(\frac{S}{14}\right)^{1.6} * \left(\frac{S}{L}\right)^{0.1} * \left(\frac{K_g}{12 * L * t_s^3}\right)^{0.1}$$

DFM =	0.601 lanes/beam
-------	------------------

0.905 Controls

**Distribution Factor for Shear Force**

both end spans and center span:

$$DFV = 0.2 + \left(\frac{S}{12}\right) - \left(\frac{S}{35}\right)^2$$

DFV =	1.082 lanes/beam
-------	------------------

one design lane loaded:

$$DFV = 0.36 + \left(\frac{S}{25}\right)$$

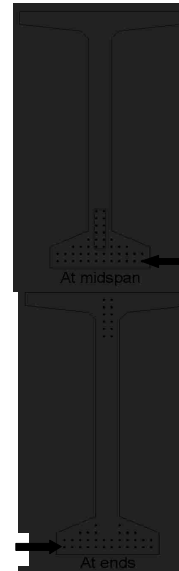
DFV =	0.840 lanes/beam
-------	------------------

1.082 Controls

	At Midspan		At Ends	
from bottom	No. of	Distance from Bottom	No. of	Distance from Bottom
layer 1	12	2	12	2
layer 2	12	4	12	4
layer 3	8	6	6	6
layer 4	4	8	2	8
layer 5	2	10	-	-
layer 6	2	12	-	-
layer 7	2	14	-	-
layer 8	2	16	-	-
layer 9	-	-	2	60
layer 10	-	-	2	62
layer 11	-	-	2	64
layer 12	-	-	2	66
layer 13	-	-	2	68
layer 14	-	-	2	70
<b>Harped Strand Group (included in above totals)</b>				
layer 3	2	6		
layer 4	2	8		
layer 5	2	10		
layer 6	2	12		
layer 7	2	14		
layer 8	2	16		

distance from the center of gravity of strands to the bottom fiber of the beam = 7% of the beam depth  
strand eccentricity at midspan = (y<sub>c</sub> - y<sub>bs</sub>)

y <sub>bs</sub> =	5.82 in
e <sub>c</sub> =	32.68 in



layer 1



## Prestress Losses

### ELASTIC SHORTENING

assumed loss	=	9.00%
Force per strand at transfer		
layer 1	=	22.8 kips
layer 2	=	28.6 kips
layer 3	=	28.9 kips
layer 4	=	28.9 kips
layer 5	=	28.9 kips
layer 6	=	28.9 kips
layer 7	=	28.9 kips
layer 8	=	28.9 kips
layer 9	=	28.9 kips
layer 10	=	28.9 kips
layer 11	=	28.9 kips
layer 12	=	28.9 kips
layer 13	=	28.9 kips
layer 14	=	28.9 kips

Total prestressing force at release	$P_1 =$	at midspan 1194.8 kips	at endspan 1194.8 kips
Sum of concrete stresses at the center of gravity of prestressing tendons due to prestressing force at transfer and the self-weight of the member at sections of maximum moment	$f_{cgp} =$	3.332 ksi	3.332 ksi
Loss due to shortening			
		at midspan	at endspan
layer 1	$\Delta f_{pES} =$	19.4 ksi	19.4 ksi
layer 2	$\Delta f_{pES} =$	20.2 ksi	20.2 ksi
layer 3	$\Delta f_{pES} =$	19.3 ksi	19.3 ksi
layer 4	$\Delta f_{pES} =$	19.3 ksi	19.3 ksi
layer 5	$\Delta f_{pES} =$	19.3 ksi	
layer 6	$\Delta f_{pES} =$	19.3 ksi	
layer 7	$\Delta f_{pES} =$	19.3 ksi	
layer 8	$\Delta f_{pES} =$	19.3 ksi	
layer 9	$\Delta f_{pES} =$		19.3 ksi
layer 10	$\Delta f_{pES} =$		19.3 ksi
layer 11	$\Delta f_{pES} =$		19.3 ksi
layer 12	$\Delta f_{pES} =$		19.3 ksi
layer 13	$\Delta f_{pES} =$		19.3 ksi
layer 14	$\Delta f_{pES} =$		19.3 ksi

### SHRINKAGE

Shrinkage = $(17-0.15 \cdot \text{Relative Humidity})$	$\Delta f_{pSR} =$	6.5 ksi	← assume relative humidity = 70%
--	--------------------	---------	----------------------------------

### CREEP OF CONCRETE

Change of stresses at center of gravity of prestressing due to permanent loads except the loads acting at time of applying prestressing force, calculated at the same section as $f_{cgp}$	$\Delta f_{cgp} =$	2.155 ksi	
loss due to creep	$\Delta f_{pCR} =$	at midspan 24.9 ksi	at endspan 24.9 ksi

### RELAXATION OF PRESTRESSING STRANDS

loss due to relaxation after transfer			
		at midspan	at endspan
layer 1	$\Delta f_{pR2} =$	1.8 ksi	1.8 ksi
layer 2	$\Delta f_{pR2} =$	1.7 ksi	1.7 ksi
layer 3	$\Delta f_{pR2} =$	1.8 ksi	1.8 ksi
layer 4	$\Delta f_{pR2} =$	1.8 ksi	1.8 ksi
layer 5	$\Delta f_{pR2} =$	1.8 ksi	
layer 6	$\Delta f_{pR2} =$	1.8 ksi	
layer 7	$\Delta f_{pR2} =$	1.8 ksi	
layer 8	$\Delta f_{pR2} =$	1.8 ksi	
layer 9	$\Delta f_{pR2} =$		1.8 ksi
layer 10	$\Delta f_{pR2} =$		1.8 ksi
layer 11	$\Delta f_{pR2} =$		1.8 ksi
layer 12	$\Delta f_{pR2} =$		1.8 ksi
layer 13	$\Delta f_{pR2} =$		1.8 ksi
layer 14	$\Delta f_{pR2} =$		1.8 ksi

**TOTAL LOSSES AT TRANSFER**

total loss  $\Delta f_{pES} = \Delta f_{pt}$

stress in tendons after transfer  $f_{pt} = f_{pi} - \Delta f_{pt}$

		at midspan	at endspan
layer 1	$f_{pt} =$	144.6 ksi	144.6 ksi
layer 2	$f_{pt} =$	185.3 ksi	185.3 ksi
layer 3	$f_{pt} =$	188.3 ksi	188.3 ksi
layer 4	$f_{pt} =$	188.3 ksi	188.3 ksi
layer 5	$f_{pt} =$	188.3 ksi	
layer 6	$f_{pt} =$	188.3 ksi	
layer 7	$f_{pt} =$	188.3 ksi	
layer 8	$f_{pt} =$	188.3 ksi	
layer 9	$f_{pt} =$		188.3 ksi
layer 10	$f_{pt} =$		188.3 ksi
layer 11	$f_{pt} =$		188.3 ksi
layer 12	$f_{pt} =$		188.3 ksi
layer 13	$f_{pt} =$		188.3 ksi
layer 14	$f_{pt} =$		188.3 ksi

force per strand =  $f_{pt} \cdot \text{strand area}$

		at midspan	at endspan
layer 1	=	22.1 kips	22.1 kips
layer 2	=	28.4 kips	28.4 kips
layer 3	=	28.8 kips	28.8 kips
layer 4	=	28.8 kips	28.8 kips
layer 5	=	28.8 kips	
layer 6	=	28.8 kips	
layer 7	=	28.8 kips	
layer 8	=	28.8 kips	
layer 9	=		28.8 kips
layer 10	=		28.8 kips
layer 11	=		28.8 kips
layer 12	=		28.8 kips
layer 13	=		28.8 kips
layer 14	=		28.8 kips
Total prestressing force after transfer	$P_i =$	1182.0 kips	1182.0 kips

Initial loss =  $(\Delta f_{pi}) / (f_{pi})$

		at midspan	at endspan
layer 1	% =	11.9%	11.9%
layer 2	% =	9.8%	9.8%
layer 3	% =	9.3%	9.3%
layer 4	% =	9.3%	9.3%
layer 5	% =	9.3%	
layer 6	% =	9.3%	
layer 7	% =	9.3%	
layer 8	% =	9.3%	
layer 9	% =		9.3%
layer 10	% =		9.3%
layer 11	% =		9.3%
layer 12	% =		9.3%
layer 13	% =		9.3%
layer 14	% =		9.3%

OK  
OK  
OK  
OK  
OK  
OK  
OK  
OK  
OK  
OK  
OK  
OK  
OK  
OK

**TOTAL LOSSES AT SERVICE LOADS**

Total Losses		at midspan	at endspan
layer 1	$\Delta f_{pT} =$	52.6 ksi	52.6 ksi
layer 2	$\Delta f_{pT} =$	53.4 ksi	53.4 ksi
layer 3	$\Delta f_{pT} =$	52.4 ksi	52.4 ksi
layer 4	$\Delta f_{pT} =$	52.4 ksi	52.4 ksi
layer 5	$\Delta f_{pT} =$	52.4 ksi	
layer 6	$\Delta f_{pT} =$	52.4 ksi	
layer 7	$\Delta f_{pT} =$	52.4 ksi	
layer 8	$\Delta f_{pT} =$	52.4 ksi	
layer 9	$\Delta f_{pT} =$		52.4 ksi
layer 10	$\Delta f_{pT} =$		52.4 ksi
layer 11	$\Delta f_{pT} =$		52.4 ksi
layer 12	$\Delta f_{pT} =$		52.4 ksi
layer 13	$\Delta f_{pT} =$		52.4 ksi
layer 14	$\Delta f_{pT} =$		52.4 ksi

Stress in tendon after all losses =  $f_{pe} - \Delta f_{pt}$

		at midspan	at endspan
layer 1	$f_{pe} =$	111.4 ksi	111.4 ksi
layer 2	$f_{pe} =$	152.1 ksi	152.1 ksi
layer 3	$f_{pe} =$	155.2 ksi	155.2 ksi
layer 4	$f_{pe} =$	155.2 ksi	155.2 ksi
layer 5	$f_{pe} =$	155.2 ksi	
layer 6	$f_{pe} =$	155.2 ksi	
layer 7	$f_{pe} =$	155.2 ksi	
layer 8	$f_{pe} =$	155.2 ksi	
layer 9	$f_{pe} =$		155.2 ksi
layer 10	$f_{pe} =$		155.2 ksi
layer 11	$f_{pe} =$		155.2 ksi
layer 12	$f_{pe} =$		155.2 ksi
layer 13	$f_{pe} =$		155.2 ksi
layer 14	$f_{pe} =$		155.2 ksi

check prestressing stress limit at service limit state:  $f_{pe} \leq 0.8 \cdot f_{py}$

layer 1	=	173.7 ksi
layer 2	=	197.7 ksi
layer 3	=	199.7 ksi
layer 4	=	199.7 ksi
layer 5	=	199.7 ksi
layer 6	=	199.7 ksi
layer 7	=	199.7 ksi
layer 8	=	199.7 ksi
layer 9	=	199.7 ksi
layer 10	=	199.7 ksi
layer 11	=	199.7 ksi
layer 12	=	199.7 ksi
layer 13	=	199.7 ksi
layer 14	=	199.7 ksi

OK  
OK  
OK  
OK  
OK  
OK  
OK  
OK  
OK  
OK  
OK  
OK  
OK  
OK

force per strand =  $f_{pe} \cdot \text{strand area}$

		at midspan	at endspan
layer 1	=	17.0 kips	17.0 kips
layer 2	=	23.3 kips	23.3 kips
layer 3	=	23.7 kips	23.7 kips
layer 4	=	23.7 kips	23.7 kips
layer 5	=	23.7 kips	
layer 6	=	23.7 kips	
layer 7	=	23.7 kips	
layer 8	=	23.7 kips	
layer 9	=		23.7 kips
layer 10	=		23.7 kips
layer 11	=		23.7 kips
layer 12	=		23.7 kips
layer 13	=		23.7 kips
layer 14	=		23.7 kips

Total prestressing force after all losses

		at midspan	at endspan
$P_{pe} =$		958.6 kips	958.6 kips

Final losses, % =  $(\Delta f_{pt}) / (f_{pi})$

layer 1	% =	32.1%	32.1%
layer 2	% =	32.6%	32.6%
layer 3	% =	32.0%	32.0%
layer 4	% =	32.0%	32.0%
layer 5	% =	32.0%	
layer 6	% =	32.0%	
layer 7	% =	32.0%	
layer 8	% =	32.0%	
layer 9	% =		32.0%
layer 10	% =		32.0%
layer 11	% =		32.0%
layer 12	% =		32.0%
layer 13	% =		32.0%
layer 14	% =		32.0%

Average final losses, %

% =		32.1%	32.0%
-----	--	-------	-------

## Stresses at Transfer

### STRESS LIMITS FOR CONCRETE

Compression = $0.6f'_{ci}$	$f_{ci} =$	3.300 ksi
Tension		
without bonded reinforcement = $-0.0948\sqrt{f'_{ci}} \leq -0.2$	=	-0.200 ksi
with bonded auxiliary reinforcement = $-0.22\sqrt{f'_{ci}}$	=	-0.016 ksi

### STRESSES AT TRANSFER LENGTH SECTION

Transfer Length = $60 \times (\text{strand diameter})$	=	2.5 ft	} Calcs for eccentricity (see 9.6.7.2)
Bending moment at transfer length	$M_y =$	116.4 ft-kips	
center of 12 strands to top fiber of beam at the end	=	7.00 in	
center of 12 strands to bottom fiber of beam at the harp point	=	11.00 in	
center of 12 strands and top fiber of beam at transfer length	=	10.78 in	
center of gravity of 32 strands and bottom fiber of beam	=	3.88 in	
center of gravity of all strands and the bottom fiber of beam at transfer length	=	19.51 in	
center of gravity of all strands and the bottom fiber of beam at the end	=	20.55 in	
Eccentricity of the strand group at transfer length:	$e_h =$	18.99 in	
Eccentricity at end of beam:	$e =$	17.95 in	

$$f_t = \frac{P_i}{A} - \frac{P_i e}{S_t} + \frac{M_g}{S_t}$$

$$f_b = \frac{P_i}{A} + \frac{P_i e}{S_b} - \frac{M_g}{S_b}$$

		at midspan	at endspan
Top stress at top fiber of beam	$f_t =$	0.176 ksi	0.176 ksi
Bottom stress at bottom fiber of the beam	$f_b =$	2.985 ksi	2.985 ksi

OK

OK

### STRESSES AT HARP POINT

Bending moment due to beam weight at 0.3L	$M_g =$	1188.0 ft-kips	
Top stress at top fiber of beam	$f_t =$	-0.039 ksi	-0.039 ksi
Bottom stress at bottom fiber of the beam	$f_b =$	3.220 ksi	3.175 ksi

OK

OK

### STRESSES AT MIDSPAN

Bending moment due to beam weight at 0.5L	$M_g =$	1414.3 ft-kips	
Top stress at top fiber of beam	$f_t =$	0.126 ksi	0.137 ksi
Bottom stress at bottom fiber of the beam	$f_b =$	3.038 ksi	2.993 ksi

OK

OK

### HOLD-DOWN FORCES

assume stress in strand before losses =  $0.8f_u$

layer 1	=	174.9 ksi
layer 2	=	219.2 ksi
layer 3	=	221.4 ksi
layer 4	=	221.4 ksi
layer 5	=	221.4 ksi
layer 6	=	221.4 ksi
layer 7	=	221.4 ksi
layer 8	=	221.4 ksi
layer 9	=	221.4 ksi
layer 10	=	221.4 ksi
layer 11	=	221.4 ksi
layer 12	=	221.4 ksi
layer 13	=	221.4 ksi
layer 14	=	221.4 ksi

prestress force per strand before any losses:

layer 1	=	26.8 kips
layer 2	=	33.5 kips
layer 3	=	33.9 kips
layer 4	=	33.9 kips
layer 5	=	33.9 kips
layer 6	=	33.9 kips
layer 7	=	33.9 kips
layer 8	=	33.9 kips
layer 9	=	33.9 kips
layer 10	=	33.9 kips
layer 11	=	33.9 kips
layer 12	=	33.9 kips
layer 13	=	33.9 kips
layer 14	=	33.9 kips
Harp Angle	$\psi =$	7.2 °

Hold-down force/strand

layer 1	=	3.5 kips/strand
layer 2	=	4.4 kips/strand
layer 3	=	4.4 kips/strand
layer 4	=	4.4 kips/strand
layer 5	=	4.4 kips/strand
layer 6	=	4.4 kips/strand
layer 7	=	4.4 kips/strand
layer 8	=	4.4 kips/strand
layer 9	=	4.4 kips/strand
layer 10	=	4.4 kips/strand
layer 11	=	4.4 kips/strand
layer 12	=	4.4 kips/strand
layer 13	=	4.4 kips/strand
layer 14	=	4.4 kips/strand
Total hold-down force	=	53.39 kips

**Stresses at Service Loads**

**STRESS LIMITS FOR CONCRETE**

**Compression:**

Due to permanent loads for load combination Service I

for the precast beam	=	2.259 ksi
for deck	=	1.800 ksi

Due to permanent and transient loads for load combination Service I

for the precast beam	=	3.012 ksi
for deck	=	2.400 ksi

**Tension:**

Load Combination Service III

for the precast beam	=	-0.013 ksi
----------------------	---	------------

**STRESSES AT MIDSPAN**

Compression stresses at top fiber of beam	at midspan	at endspan	
$f_i = \frac{P_{pe}}{A} - \frac{P_{pe}e}{S_i} + \frac{(M_{ps} + M_{s1})}{S_i} + \frac{(M_{ps} + M_{s1})}{S_{te}}$			
Due to permanent loads	$f_{ig} =$	1.993 ksi	1.993 ksi
			OK
$f_{tr} = \frac{P_{pe}}{A} - \frac{P_{pe}e}{S_i} + \frac{(M_{ps} + M_{s1})}{S_i} + \frac{(M_{ps} - M_{s1})}{S_{te}} + \frac{(M_{tr,1})}{S_{te}}$			
Due to permanent loads and transient loads	$f_{ig} =$	2.384 ksi	2.384 ksi
			OK
Compression stresses at top fiber of deck	at midspan	at endspan	
$f_{tr} = \frac{(M_{ps} + M_{s1})}{S_{tr}}$			
Due to permanent loads	$f_{ig} =$	0.051 ksi	0.051 ksi
			OK
$f_{tr} = \frac{(M_{ps} + M_{s1} + M_{tr,1})}{S_{tr}}$			
Due to permanent loads and transient loads	$f_{ig} =$	0.589 ksi	0.589 ksi
			OK
Tension stresses at top fiber of deck	at midspan	at endspan	
$f_{tr} = \frac{P_{pe}}{A} + \frac{P_{pe}e}{S_i} - \frac{(M_{ps} + M_{s1})}{S_i} - \frac{(M_{ps} + M_{s1} + 0.8M_{tr,1})}{S_{tr}}$			
Load Combination Service III	$f_b =$	-0.839 ksi	-0.839 ksi
			OK

### Strength Limit State

POSITIVE MOMENT SECTION		
$M_u = 1.25DC+1.5DW+1.75(LL+IM)$	$M_u =$	8381.5 ft-kips
effective length factor for compression members		
layer 1	k =	0.09
layer 2	k =	0.28
layer 3	k =	0.28
layer 4	k =	0.28
layer 5	k =	0.28
layer 6	k =	0.28
layer 7	k =	0.28
layer 8	k =	0.28
layer 9	k =	0.28
layer 10	k =	0.28
layer 11	k =	0.28
layer 12	k =	0.28
layer 13	k =	0.28
layer 14	k =	0.28
	c =	5.4 ft-kips

average stress in prestressing steel

layer 1	$f_{ps} =$	217.2 ksi
layer 2	$f_{ps} =$	272.2 ksi
layer 3	$f_{ps} =$	274.9 ksi
layer 4	$f_{ps} =$	274.9 ksi
layer 5	$f_{ps} =$	274.9 ksi
layer 6	$f_{ps} =$	274.9 ksi
layer 7	$f_{ps} =$	274.9 ksi
layer 8	$f_{ps} =$	274.9 ksi
layer 9	$f_{ps} =$	274.9 ksi
layer 10	$f_{ps} =$	274.9 ksi
layer 11	$f_{ps} =$	274.9 ksi
layer 12	$f_{ps} =$	274.9 ksi
layer 13	$f_{ps} =$	274.9 ksi
layer 14	$f_{ps} =$	274.9 ksi

nominal flexure resistance

	a =	4.60 in	
$M_r = \Phi M_n, \Phi = 1.00$	$\Phi M_n =$	10385.8 ft-kips	OK
M=DC+W+LL+IM	M =	5833.6 ft-kips	OK

NEGATIVE MOMENT SECTION		
$M_u = 1.25DC+1.5DW+1.75(LL+IM)$	$M_u =$	4837.2 ft-kips
	a =	7.99 in
	$\Phi M_n =$	4803.8 ft-kips
M=DC+W+LL+IM	M =	2869.7 ft-kips

NOT OK  
OK

### Shear Design

CRITICAL SECTION AT 0.59		
$V_u = 1.25DC+1.5DW+1.75(LL+IM)$	$V_u =$	405.0 kips
$M_u = 1.25DC+1.5DW+1.75(LL+IM)$	$M_u =$	-2684.4 ft-kips
or		
$V_u = 1.25DC+1.5DW+1.75(LL+IM)$	$V_u =$	364.8 kips
$M_u = 1.25DC+1.5DW+1.75(LL+IM)$	$M_u =$	-2877.0 ft-kips
max shear	$V_u =$	405.0 kips
max moment	$M_u =$	2877.0 ft-kips
Shear depth	$d_v =$	73.19 in
Applied factored normal force at the section	$N_u =$	0
Angle of diagonal compressive stresses	$\theta =$	36.00 °

**STRAIN IN FLEXURAL TENSION REINFORCEMENT**

$$\epsilon_r = \frac{\frac{\Delta f_c}{\alpha_v} + 0.5N_e + 0.2N_e \cos \theta + A_{ps} f_{ps}}{E_c A_c + E_s A_s} \leq 0.002$$

		at midspan	at endspan
resultant compressive stress at centroid	$f_{pc} =$	0.723 ksi	0.723 ksi

effective stress in prestressing strand after all losses

		at midspan	at endspan
layer 1	$f_{po} =$	115.8 ksi	115.8 ksi
layer 2	$f_{po} =$	156.7 ksi	156.7 ksi
layer 3	$f_{po} =$	159.5 ksi	159.5 ksi
layer 4	$f_{po} =$	159.5 ksi	159.5 ksi
layer 5	$f_{po} =$	159.5 ksi	
layer 6	$f_{po} =$	159.5 ksi	
layer 7	$f_{po} =$	159.5 ksi	
layer 8	$f_{po} =$	159.5 ksi	
layer 9	$f_{po} =$		159.5 ksi
layer 10	$f_{po} =$		159.5 ksi
layer 11	$f_{po} =$		159.5 ksi
layer 12	$f_{po} =$		159.5 ksi
layer 13	$f_{po} =$		159.5 ksi
layer 14	$f_{po} =$		159.5 ksi

strain in flexural tension

		at midspan	at endspan
layer 1	$\epsilon_x =$	0.002000	0.002000
layer 2	$\epsilon_x =$	0.002000	0.002000
layer 3	$\epsilon_x =$	0.002000	0.002000
layer 4	$\epsilon_x =$	0.002000	0.002000
layer 5	$\epsilon_x =$	0.002000	
layer 6	$\epsilon_x =$	0.002000	
layer 7	$\epsilon_x =$	0.002000	
layer 8	$\epsilon_x =$	0.002000	
layer 9	$\epsilon_x =$		0.002000
layer 10	$\epsilon_x =$		0.002000
layer 11	$\epsilon_x =$		0.002000
layer 12	$\epsilon_x =$		0.002000
layer 13	$\epsilon_x =$		0.002000
layer 14	$\epsilon_x =$		0.002000

**Deflection and Camber**

		at midspan	at endspan
Deflection due to Prestressing Force at Transfer	$\Delta_p =$	4.05 in	3.97 in
Deflection due to Beam Self-Weight at Transfer	$\Delta_g =$	-1.95 in	
Deflection due to Beam Self-Weight at Erection	$\Delta_g =$	-1.97 in	
Deflection due to Haunch and Deck	$\Delta_s =$	-3.01 in	

Deflection due to total self weight	$\Delta_{sw} =$	-0.93 in
-------------------------------------	-----------------	----------

Total Deflection at transfer	$\Delta =$	2.10 in	2.02 in
Total Deflection at erection	$\Delta =$	3.65 in	3.50 in

Live load deflection limit = span/800	$=$	-1.80 in
Deflection due to live load and impact	$\Delta_L =$	-1.07 in

Deflection due to fire truck	$\Delta_L =$	-2.2365 in
Total Deflection after fire with fire truck	$\Delta =$	0.8807 in

OK

NOT OK

**Parametric Design: Puyallup River Case Study**  
**Beam Design: 1/2" Strand**  
**Fire Exposure Status: 2 Hours**

(PCI Bridge Design Manual Section 9.6)

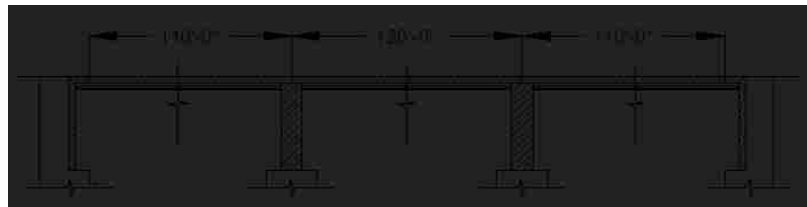


**Material Properties**

CAST-IN-PLACE SLAB		
Actual Thickness	$t_{as} =$	8.0 in
Wearing Surface	$=$	0.5 in
Structural thickness = Actual - Wearing Surface	$t_s =$	7.5 in
Compressive Strength	$f'_c =$	4 ksi
Unit Weight	$w_c =$	150.0 pcf
Stress factor of compression block	$\beta_1 =$	0.85

BEAMS: AASHTO-PCI, BT-72 BULB-TEE		
Strength at release	$f'_{ci} =$	5.5 ksi
Strength at 28 days	$f'_c =$	4.40 ksi
Unit Weight	$w_c =$	150.0 pcf
Overall Beam Length:		
@ end spans	$L =$	110 ft
@ center span	$L =$	119 ft
Design Spans:		
Non-composite beam @ end spans	$L =$	109 ft
Non-composite beam @ center span	$L =$	118 ft
Composite beam @ end spans	$L =$	110 ft
Composite beam @ center span	$L =$	120 ft
Beam Spacing	$S =$	12 ft





**PRESTRESSING STRANDS**

Diameter of single strand	d =	0.5 in
Area of single strand	A =	0.153 in <sup>2</sup>

Temperature of Layer	layer 1 (bottom)	T =	1270.00 °F
	layer 2	T =	590.00 °F
	layer 3	T =	68.00 °F
	layer 4	T =	68.00 °F
	layer 5	T =	68.00 °F
	layer 6	T =	68.00 °F
	layer 7	T =	68.00 °F
	layer 8	T =	68.00 °F
	layer 9	T =	68.00 °F
	layer 10	T =	68.00 °F
	layer 11	T =	68.00 °F
	layer 12	T =	68.00 °F
	layer 13	T =	68.00 °F
	layer 14	T =	68.00 °F

Ultimate Strength initial = 277 ksi	layer 1 (bottom)	f <sub>pu</sub> =	104 ksi
	layer 2	f <sub>pu</sub> =	263 ksi
	layer 3	f <sub>pu</sub> =	277 ksi
	layer 4	f <sub>pu</sub> =	277 ksi
	layer 5	f <sub>pu</sub> =	277 ksi
	layer 6	f <sub>pu</sub> =	277 ksi
	layer 7	f <sub>pu</sub> =	277 ksi
	layer 8	f <sub>pu</sub> =	277 ksi
	layer 9	f <sub>pu</sub> =	277 ksi
	layer 10	f <sub>pu</sub> =	277 ksi
	layer 11	f <sub>pu</sub> =	277 ksi
	layer 12	f <sub>pu</sub> =	277 ksi
	layer 13	f <sub>pu</sub> =	277 ksi
	layer 14	f <sub>pu</sub> =	277 ksi

Yield Strength initial = 250 ksi	layer 1 (bottom)	f <sub>py</sub> =	102 ksi
	layer 2	f <sub>py</sub> =	240 ksi
	layer 3	f <sub>py</sub> =	245 ksi
	layer 4	f <sub>py</sub> =	245 ksi
	layer 5	f <sub>py</sub> =	247 ksi
	layer 6	f <sub>py</sub> =	247 ksi
	layer 7	f <sub>py</sub> =	247 ksi
	layer 8	f <sub>py</sub> =	247 ksi
	layer 9	f <sub>py</sub> =	250 ksi
	layer 10	f <sub>py</sub> =	250 ksi
	layer 11	f <sub>py</sub> =	250 ksi
	layer 12	f <sub>py</sub> =	250 ksi
	layer 13	f <sub>py</sub> =	250 ksi
	layer 14	f <sub>py</sub> =	250 ksi

<b>Stress Limits:</b> before transfer ≤ 0.75f <sub>pu</sub> (initial = 202.5)	layer 1 (bottom)	f <sub>pi</sub> =	77.9 ksi
	layer 2	f <sub>pi</sub> =	197.2 ksi
	layer 3	f <sub>pi</sub> =	207.6 ksi
	layer 4	f <sub>pi</sub> =	207.6 ksi
	layer 5	f <sub>pi</sub> =	207.6 ksi
	layer 6	f <sub>pi</sub> =	207.6 ksi
	layer 7	f <sub>pi</sub> =	207.6 ksi
	layer 8	f <sub>pi</sub> =	207.6 ksi
	layer 9	f <sub>pi</sub> =	207.6 ksi
	layer 10	f <sub>pi</sub> =	207.6 ksi
	layer 11	f <sub>pi</sub> =	207.6 ksi
	layer 12	f <sub>pi</sub> =	207.6 ksi
	layer 13	f <sub>pi</sub> =	207.6 ksi
	layer 14	f <sub>pi</sub> =	207.6 ksi

at service limit state (after all losses)  $\leq 0.80f_{py}$  (initial = 194.4)

layer 1 (bottom)	$f_{pe} =$	81.9 ksi
layer 2	$f_{pe} =$	191.7 ksi
layer 3	$f_{pe} =$	195.7 ksi
layer 4	$f_{pe} =$	195.7 ksi
layer 5	$f_{pe} =$	197.7 ksi
layer 6	$f_{pe} =$	197.7 ksi
layer 7	$f_{pe} =$	197.7 ksi
layer 8	$f_{pe} =$	197.7 ksi
layer 9	$f_{pe} =$	199.7 ksi
layer 10	$f_{pe} =$	199.7 ksi
layer 11	$f_{pe} =$	199.7 ksi
layer 12	$f_{pe} =$	199.7 ksi
layer 13	$f_{pe} =$	199.7 ksi
layer 14	$f_{pe} =$	199.7 ksi

Modulus of Elasticity

initial = 25982 ksi

layer 1 (bottom)	E =	25462.4 ksi
layer 2	E =	27281.1 ksi
layer 3	E =	25982.0 ksi
layer 4	E =	25982.0 ksi
layer 5	E =	25982.0 ksi
layer 6	E =	25982.0 ksi
layer 7	E =	25982.0 ksi
layer 8	E =	25982.0 ksi
layer 9	E =	25982.0 ksi
layer 10	E =	25982.0 ksi
layer 11	E =	25982.0 ksi
layer 12	E =	25982.0 ksi
layer 13	E =	25982.0 ksi
layer 14	E =	25982.0 ksi

#### REINFORCING BARS

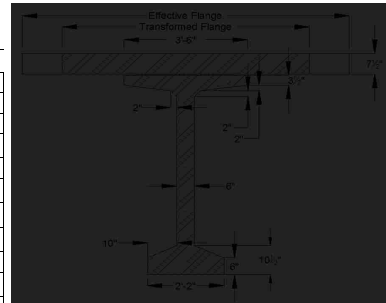
Yield Strength	$f_y =$	57.6 ksi
Modulus of Elasticity	E =	29000.0 ksi

Area of steel at endspan (effective flange)	$A_{se} =$	15.4 in <sup>2</sup>
Area of steel at midspan (effective flange)	$A_{sm} =$	0.0 in <sup>2</sup>
Area of temperature and shrinkage steel (12" width)	$A_{st} =$	0.0 in <sup>2</sup>

#### Cross-sectional Properties

##### NON-COMPOSITE BEAM

Area of cross-section of beam	A =	767.0 in <sup>2</sup>
Overall depth of beam	H =	72.0 in
Moment of Inertia	I =	386,902 in <sup>4</sup>
Distance from centroid to extreme <b>bottom</b> fiber	$y_b =$	40.3 in
Distance from centroid to extreme <b>top</b> fiber	$y_t =$	31.7 in
Section modulus for the extreme <b>bottom</b> fiber	$S_b =$	14915.0 in <sup>3</sup>
Section modulus for the extreme <b>top</b> fiber	$S_t =$	15421.0 in <sup>3</sup>
Weight	$W_t =$	799.0 plf
Modulus of Elasticity = $33000 \cdot (W_c \cdot 1.5) \cdot (\sqrt{f_c})$		
cast-in-place concrete deck	$E_{cs} =$	3834 ksi
precast beam at release	$E_{c0} =$	4496 ksi
precast beam at service loads	$E_c =$	4021 ksi



**COMPOSITE BEAM AT MIDSPAN**

Effective Flange Width	$b_f =$	111.0 in	*min of three criteria
Modular Ratio = $E_{cs}/E_c$	$n =$	0.9535	
Transformed flange width	$=$	105.8 in	
Transformed flange area	$=$	793.8 in <sup>2</sup>	
Transformed haunch width	$=$	40.0 in	
Transformed haunch area	$=$	20.0 in <sup>2</sup>	

	Transformed Area	$y_b$	$Ay_b$	$A(y_{bc}-y_b)^2$	I	$I + A(y_{bc}-y_b)^2$
Beam	767.0 in <sup>2</sup>	40.31 in	30,917.8 in <sup>3</sup>	261,121 in <sup>4</sup>	386,902 in <sup>4</sup>	648,022 in <sup>4</sup>
Haunch	20.0 in <sup>2</sup>	72.25 in	1,446.6 in <sup>3</sup>	3,643 in <sup>4</sup>	0.33 in <sup>4</sup>	3,643 in <sup>4</sup>
Deck	793.8 in <sup>2</sup>	76.25 in	60,524.0 in <sup>3</sup>	242,779 in <sup>4</sup>	2,950 in <sup>4</sup>	245,729 in <sup>4</sup>
Total	1580.8 in <sup>2</sup>		92,888.4 in <sup>3</sup>			897,395 in <sup>4</sup>

Total area of Composite Section	$A_c =$	1581 in <sup>2</sup>
Overall Depth of the Composite Section	$h_c =$	80 in
Moment of Inertia	$I_c =$	897,395 in <sup>4</sup>
Distance from centroid to extreme <u>bottom</u> fiber of beam	$y_{bc} =$	58.76 in
Distance from centroid to extreme <u>top</u> fiber of beam	$y_{tb} =$	13.24 in
Distance from centroid to extreme <u>top</u> fiber of slab	$y_{tc} =$	21.24 in
Section modulus for the extreme <u>bottom</u> fiber of beam	$S_{bc} =$	15,271.9 in <sup>3</sup>
Section modulus for the extreme <u>top</u> fiber of beam	$S_{tb} =$	67,784.8 in <sup>3</sup>
Section modulus for the extreme <u>top</u> fiber slab	$S_{tc} =$	44,314.7 in <sup>3</sup>

**Shear Forces and Bending Moments**

**DEAD LOADS**

Beam self-weight	$w_{beam} =$	0.799 k/f
8 in. deck weight	$w_{deck} =$	1.200 k/f
1/2 in. haunch weight	$w_{haunch} =$	0.022 k/f

LRFD Specifications: Art. 4.6.2.2.1		
Width of Deck Constant		OK
Number of beams is not less than four $N_b =$	4	OK
Roadway part of the overhang, $d_o \leq 3.0$ ft, $d_o =$	1.5	OK
Curvature in plans is less than $4^\circ =$	0	OK
Cross-section of the bridge is consistent with one of the cross sections given by LRFD specs		OK

Barrier and wearing surface loads are equally distributed among the 4 beams

Barrier Wt	$Wt =$	0.150 k/f
Dead load of future wearing surface	$DW =$	0.263 k/f

**LIVE LOADS**

Fire truck live load front load (Point A)	$P_{live} =$	48.0 kips
Fire truck live load back load (Point B)	$P_{live} =$	22.0 kips
distance between two loads		19.2 ft
distance from nearest edge to point A	$x_a =$	59.0 ft
distance from nearest edge to point B	$x_b =$	39.8 ft

LRFD Specifications: Art. 4.6.2.2.1		
Width of Deck Constant		OK
Number of beams is not less than four $N_b =$	4	OK
Beams are parallel and approximately of the same stiffness		OK
Roadway part of the overhang, $d_o \leq 3.0$ ft, $d_o =$	1.5	OK
Curvature in plans is less than $4^\circ =$	0	OK

Barrier and wearing surface loads are equally distributed among the 4 beams

Bridge Type-- "k" (LRFD Table 4.6.2.2.1-1)		
Number of design lanes = $w/12$	$=$	3 lanes

**Distribution Factor for Bending Moment:**

Beams spacing	S =	12.0 ft
Depth of concrete slab	t <sub>s</sub> =	7.5 in
Beam Span	L =	120.0 ft
Number of Beams	N <sub>b</sub> =	4
Modular ratio between beam & deck materials	n =	1.0488
Longitudinal stiffness parameter	K <sub>g</sub> =	1,670,458.43 in <sup>4</sup>

at center span:

$$DFM = 0.75 + \left(\frac{S}{9.5}\right)^{0.4} * \left(\frac{S}{L}\right)^{0.3} * \left(\frac{K_g}{12 * L * t_s^3}\right)^{0.1}$$

DFM =	0.878 lanes/beam
-------	------------------

one design lane loaded:

$$DFM = 0.75 - \left(\frac{S}{14}\right)^{1.4} * \left(\frac{S}{L}\right)^{1.3} * \left(\frac{K_g}{12 * L * t_s^3}\right)^{0.1}$$

DFM =	0.596 lanes/beam
-------	------------------

0.905 Controls

**Distribution Factor for Shear Force**

both end spans and center span:

$$DFV = 0.2 + \left(\frac{S}{12}\right) - \left(\frac{S}{35}\right)^2$$

DFV =	1.082 lanes/beam
-------	------------------

one design lane loaded:

$$DFV = 0.36 \left(\frac{S}{25}\right)$$

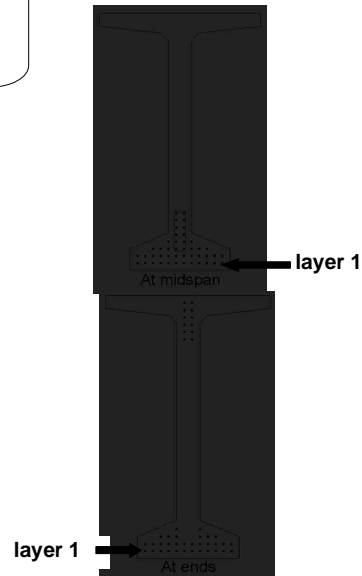
DFV =	0.840 lanes/beam
-------	------------------

1.082 Controls

from bottom	At Midspan		At Ends	
	No. of	Distance from Bottom	No. of	Distance from Bottom
layer 1	12	2	12	2
layer 2	12	4	12	4
layer 3	8	6	6	6
layer 4	4	8	2	8
layer 5	2	10	-	-
layer 6	2	12	-	-
layer 7	2	14	-	-
layer 8	2	16	-	-
layer 9	-	-	2	60
layer 10	-	-	2	62
layer 11	-	-	2	64
layer 12	-	-	2	66
layer 13	-	-	2	68
layer 14	-	-	2	70
<b>Harped Strand Group (included in above totals)</b>				
layer 3	2	6		
layer 4	2	8		
layer 5	2	10		
layer 6	2	12		
layer 7	2	14		
layer 8	2	16		

distance from the center of gravity of strands to the bottom fiber of the beam = 7% of the beam depth  
strand eccentricity at midspan = (y<sub>c</sub> - y<sub>bs</sub>)

y <sub>bs</sub> =	5.82 in
e <sub>c</sub> =	34.49 in



## Prestress Losses

### ELASTIC SHORTENING

assumed loss	=	9.00%
Force per strand at transfer		
layer 1	=	10.8 kips
layer 2	=	27.5 kips
layer 3	=	28.9 kips
layer 4	=	28.9 kips
layer 5	=	28.9 kips
layer 6	=	28.9 kips
layer 7	=	28.9 kips
layer 8	=	28.9 kips
layer 9	=	28.9 kips
layer 10	=	28.9 kips
layer 11	=	28.9 kips
layer 12	=	28.9 kips
layer 13	=	28.9 kips
layer 14	=	28.9 kips

Total prestressing force at release	$P_1 =$	at midspan 1037.6 kips	at endspan 1037.6 kips
Sum of concrete stresses at the center of gravity of prestressing tendons due to prestressing force at transfer and the self-weight of the member at sections of maximum moment	$f_{cgp} =$	3.056 ksi	3.056 ksi
Loss due to shortening		at midspan	at endspan
layer 1	$\Delta f_{pES} =$	17.3 ksi	17.3 ksi
layer 2	$\Delta f_{pES} =$	18.5 ksi	18.5 ksi
layer 3	$\Delta f_{pES} =$	17.7 ksi	17.7 ksi
layer 4	$\Delta f_{pES} =$	17.7 ksi	17.7 ksi
layer 5	$\Delta f_{pES} =$	17.7 ksi	
layer 6	$\Delta f_{pES} =$	17.7 ksi	
layer 7	$\Delta f_{pES} =$	17.7 ksi	
layer 8	$\Delta f_{pES} =$	17.7 ksi	
layer 9	$\Delta f_{pES} =$		17.7 ksi
layer 10	$\Delta f_{pES} =$		17.7 ksi
layer 11	$\Delta f_{pES} =$		17.7 ksi
layer 12	$\Delta f_{pES} =$		17.7 ksi
layer 13	$\Delta f_{pES} =$		17.7 ksi
layer 14	$\Delta f_{pES} =$		17.7 ksi

### SHRINKAGE

Shrinkage = $(17-0.15 \cdot \text{Relative Humidity})$	$\Delta f_{pSR} =$	6.5 ksi	← assume relative humidity = 70%
--	--------------------	---------	----------------------------------

### CREEP OF CONCRETE

Change of stresses at center of gravity of prestressing due to permanent loads except the loads acting at time of applying prestressing force, calculated at the same section as $f_{cgp}$	$\Delta f_{cgp} =$	2.418 ksi	
loss due to creep	$\Delta f_{pCR} =$	at midspan 19.7 ksi	at endspan 19.7 ksi

### RELAXATION OF PRESTRESSING STRANDS

loss due to relaxation after transfer		at midspan	at endspan
layer 1	$\Delta f_{pR2} =$	2.3 ksi	2.3 ksi
layer 2	$\Delta f_{pR2} =$	2.2 ksi	2.2 ksi
layer 3	$\Delta f_{pR2} =$	2.3 ksi	2.3 ksi
layer 4	$\Delta f_{pR2} =$	2.3 ksi	2.3 ksi
layer 5	$\Delta f_{pR2} =$	2.3 ksi	
layer 6	$\Delta f_{pR2} =$	2.3 ksi	
layer 7	$\Delta f_{pR2} =$	2.3 ksi	
layer 8	$\Delta f_{pR2} =$	2.3 ksi	
layer 9	$\Delta f_{pR2} =$		2.3 ksi
layer 10	$\Delta f_{pR2} =$		2.3 ksi
layer 11	$\Delta f_{pR2} =$		2.3 ksi
layer 12	$\Delta f_{pR2} =$		2.3 ksi
layer 13	$\Delta f_{pR2} =$		2.3 ksi
layer 14	$\Delta f_{pR2} =$		2.3 ksi

**TOTAL LOSSES AT TRANSFER**

total loss  $\Delta f_{pES} = \Delta f_{pt}$

stress in tendons after transfer  $f_{pt} = f_{pi} - \Delta f_{pi}$

		at midspan	at endspan
layer 1	$f_{pt} =$	60.5 ksi	60.5 ksi
layer 2	$f_{pt} =$	178.7 ksi	178.7 ksi
layer 3	$f_{pt} =$	189.9 ksi	189.9 ksi
layer 4	$f_{pt} =$	189.9 ksi	189.9 ksi
layer 5	$f_{pt} =$	189.9 ksi	
layer 6	$f_{pt} =$	189.9 ksi	
layer 7	$f_{pt} =$	189.9 ksi	
layer 8	$f_{pt} =$	189.9 ksi	
layer 9	$f_{pt} =$		189.9 ksi
layer 10	$f_{pt} =$		189.9 ksi
layer 11	$f_{pt} =$		189.9 ksi
layer 12	$f_{pt} =$		189.9 ksi
layer 13	$f_{pt} =$		189.9 ksi
layer 14	$f_{pt} =$		189.9 ksi

force per strand =  $f_{pt} \cdot \text{strand area}$

		at midspan	at endspan
layer 1	=	9.3 kips	9.3 kips
layer 2	=	27.3 kips	27.3 kips
layer 3	=	29.1 kips	29.1 kips
layer 4	=	29.1 kips	29.1 kips
layer 5	=	29.1 kips	
layer 6	=	29.1 kips	
layer 7	=	29.1 kips	
layer 8	=	29.1 kips	
layer 9	=		29.1 kips
layer 10	=		29.1 kips
layer 11	=		29.1 kips
layer 12	=		29.1 kips
layer 13	=		29.1 kips
layer 14	=		29.1 kips

Total prestressing force after transfer

Initial loss =  $(\Delta f_{pi}) / (f_{pi})$

		at midspan	at endspan
layer 1	% =	22.2%	22.2%
layer 2	% =	9.4%	9.4%
layer 3	% =	8.5%	8.5%
layer 4	% =	8.5%	8.5%
layer 5	% =	8.5%	
layer 6	% =	8.5%	
layer 7	% =	8.5%	
layer 8	% =	8.5%	
layer 9	% =		8.5%
layer 10	% =		8.5%
layer 11	% =		8.5%
layer 12	% =		8.5%
layer 13	% =		8.5%
layer 14	% =		8.5%

OK  
OK  
OK  
OK  
OK  
OK  
OK  
OK  
OK  
OK  
OK  
OK  
OK  
OK

**TOTAL LOSSES AT SERVICE LOADS**

Total Losses

		at midspan	at endspan
layer 1	$\Delta f_{pT} =$	45.9 ksi	45.9 ksi
layer 2	$\Delta f_{pT} =$	47.1 ksi	47.1 ksi
layer 3	$\Delta f_{pT} =$	46.2 ksi	46.2 ksi
layer 4	$\Delta f_{pT} =$	46.2 ksi	46.2 ksi
layer 5	$\Delta f_{pT} =$	46.2 ksi	
layer 6	$\Delta f_{pT} =$	46.2 ksi	
layer 7	$\Delta f_{pT} =$	46.2 ksi	
layer 8	$\Delta f_{pT} =$	46.2 ksi	
layer 9	$\Delta f_{pT} =$		46.2 ksi
layer 10	$\Delta f_{pT} =$		46.2 ksi
layer 11	$\Delta f_{pT} =$		46.2 ksi
layer 12	$\Delta f_{pT} =$		46.2 ksi
layer 13	$\Delta f_{pT} =$		46.2 ksi
layer 14	$\Delta f_{pT} =$		46.2 ksi

Stress in tendon after all losses =  $f_{pt} - \Delta f_{pt}$

		at midspan	at endspan
layer 1	$f_{pe} =$	32.0 ksi	32.0 ksi
layer 2	$f_{pe} =$	150.1 ksi	150.1 ksi
layer 3	$f_{pe} =$	161.4 ksi	161.4 ksi
layer 4	$f_{pe} =$	161.4 ksi	161.4 ksi
layer 5	$f_{pe} =$	161.4 ksi	
layer 6	$f_{pe} =$	161.4 ksi	
layer 7	$f_{pe} =$	161.4 ksi	
layer 8	$f_{pe} =$	161.4 ksi	
layer 9	$f_{pe} =$		161.4 ksi
layer 10	$f_{pe} =$		161.4 ksi
layer 11	$f_{pe} =$		161.4 ksi
layer 12	$f_{pe} =$		161.4 ksi
layer 13	$f_{pe} =$		161.4 ksi
layer 14	$f_{pe} =$		161.4 ksi

check prestressing stress limit at service limit state:  $f_{pe} \leq 0.8 \cdot f_{py}$

layer 1	=	81.9 ksi
layer 2	=	191.7 ksi
layer 3	=	195.7 ksi
layer 4	=	195.7 ksi
layer 5	=	197.7 ksi
layer 6	=	197.7 ksi
layer 7	=	197.7 ksi
layer 8	=	197.7 ksi
layer 9	=	199.7 ksi
layer 10	=	199.7 ksi
layer 11	=	199.7 ksi
layer 12	=	199.7 ksi
layer 13	=	199.7 ksi
layer 14	=	199.7 ksi

OK  
OK  
OK  
OK  
OK  
OK  
OK  
OK  
OK  
OK  
OK  
OK  
OK  
OK

force per strand =  $f_{pe} \cdot \text{strand area}$

		at midspan	at endspan
layer 1	=	4.9 kips	4.9 kips
layer 2	=	23.0 kips	23.0 kips
layer 3	=	24.7 kips	24.7 kips
layer 4	=	24.7 kips	24.7 kips
layer 5	=	24.7 kips	
layer 6	=	24.7 kips	
layer 7	=	24.7 kips	
layer 8	=	24.7 kips	
layer 9	=		24.7 kips
layer 10	=		24.7 kips
layer 11	=		24.7 kips
layer 12	=		24.7 kips
layer 13	=		24.7 kips
layer 14	=		24.7 kips

Total prestressing force after all losses

		at midspan	at endspan
$P_{pe} =$		828.0 kips	828.0 kips

Final losses, % =  $(\Delta f_{pt}) / (f_{pi})$

layer 1	% =	59.0%	59.0%
layer 2	% =	60.5%	60.5%
layer 3	% =	59.4%	59.4%
layer 4	% =	59.4%	59.4%
layer 5	% =	59.4%	
layer 6	% =	59.4%	
layer 7	% =	59.4%	
layer 8	% =	59.4%	
layer 9	% =		59.4%
layer 10	% =		59.4%
layer 11	% =		59.4%
layer 12	% =		59.4%
layer 13	% =		59.4%
layer 14	% =		59.4%
Average final losses, %	% =	59.5%	59.5%

### Stresses at Transfer

#### STRESS LIMITS FOR CONCRETE

Compression = $0.6f'_{ci}$	$f_{ci} =$	3.300 ksi
Tension		
without bonded reinforcement = $-0.0948\sqrt{f'_{ci}} \leq -0.2$	$=$	-0.200 ksi
with bonded auxiliary reinforcement = $-0.22\sqrt{f'_{ci}}$	$=$	-0.016 ksi

#### STRESSES AT TRANSFER LENGTH SECTION

Transfer Length = $60 \times$ (strand diameter)	$=$	2.5 ft	} Calcs for eccentricity (see 9.6.7.2)
Bending moment at transfer length	$M_D =$	116.4 ft-kips	
center of 12 strands to top fiber of beam at the end	$=$	7.00 in	
center of 12 strands to bottom fiber of beam at the harp point	$=$	11.00 in	
center of 12 strands and top fiber of beam at transfer length	$=$	10.78 in	
center of gravity of 32 strands and bottom fiber of beam	$=$	3.88 in	
center of gravity of all strands and the bottom fiber of beam at transfer length	$=$	19.51 in	
center of gravity of all strands and the bottom fiber of beam at the end	$=$	20.55 in	
Eccentricity of the strand group at transfer length:	$e_n =$	20.80 in	}
Eccentricity at end of beam:	$e =$	19.76 in	

$$f_t = \frac{P_i}{A} - \frac{P_i e}{S_t} + \frac{M_D}{S_t}$$

$$f_b = \frac{P_i}{A} + \frac{P_i e}{S_b} - \frac{M_D}{S_b}$$

		at midspan	at endspan	
Top stress at top fiber of beam	$f_t =$	0.045 ksi	0.045 ksi	OK
Bottom stress at bottom fiber of the beam	$f_b =$	2.706 ksi	2.706 ksi	OK

#### STRESSES AT HARP POINT

Bending moment due to beam weight at 0.3L	$M_D =$	1188.0 ft-kips		
Top stress at top fiber of beam	$f_t =$	-0.028 ksi	-0.028 ksi	OK
Bottom stress at bottom fiber of the beam	$f_b =$	2.796 ksi	2.737 ksi	OK

#### STRESSES AT MIDSPAN

Bending moment due to beam weight at 0.5L	$M_D =$	1414.3 ft-kips		
Top stress at top fiber of beam	$f_t =$	0.133 ksi	0.148 ksi	OK
Bottom stress at bottom fiber of the beam	$f_b =$	2.614 ksi	2.555 ksi	OK

#### HOLD-DOWN FORCES

assume stress in strand before losses =  $0.8f_u$

layer 1	$=$	83.0 ksi
layer 2	$=$	210.4 ksi
layer 3	$=$	221.4 ksi
layer 4	$=$	221.4 ksi
layer 5	$=$	221.4 ksi
layer 6	$=$	221.4 ksi
layer 7	$=$	221.4 ksi
layer 8	$=$	221.4 ksi
layer 9	$=$	221.4 ksi
layer 10	$=$	221.4 ksi
layer 11	$=$	221.4 ksi
layer 12	$=$	221.4 ksi
layer 13	$=$	221.4 ksi
layer 14	$=$	221.4 ksi

prestressing force per strand before any losses:

layer 1	$=$	12.7 kips
layer 2	$=$	32.2 kips
layer 3	$=$	33.9 kips
layer 4	$=$	33.9 kips
layer 5	$=$	33.9 kips
layer 6	$=$	33.9 kips
layer 7	$=$	33.9 kips
layer 8	$=$	33.9 kips
layer 9	$=$	33.9 kips
layer 10	$=$	33.9 kips
layer 11	$=$	33.9 kips
layer 12	$=$	33.9 kips
layer 13	$=$	33.9 kips
layer 14	$=$	33.9 kips
Harp Angle	$\psi =$	7.2 °



Hold-down force/strand

layer 1	=	1.7 kips/strand
layer 2	=	4.2 kips/strand
layer 3	=	4.4 kips/strand
layer 4	=	4.4 kips/strand
layer 5	=	4.4 kips/strand
layer 6	=	4.4 kips/strand
layer 7	=	4.4 kips/strand
layer 8	=	4.4 kips/strand
layer 9	=	4.4 kips/strand
layer 10	=	4.4 kips/strand
layer 11	=	4.4 kips/strand
layer 12	=	4.4 kips/strand
layer 13	=	4.4 kips/strand
layer 14	=	4.4 kips/strand
Total hold-down force	=	53.39 kips

**Stresses at Service Loads**

**STRESS LIMITS FOR CONCRETE**

**Compression:**

Due to permanent loads for load combination Service I

for the precast beam	=	1.980 ksi
for deck	=	1.800 ksi

Due to permanent and transient loads for load combination Service I

for the precast beam	=	2.640 ksi
for deck	=	2.400 ksi

**Tension:**

Load Combination Service III

for the precast beam	=	-0.013 ksi
----------------------	---	------------

**STRESSES AT MIDSPAN**

Compression stresses at top fiber of beam	at midspan	at endspan
$f_t = \frac{P_{pe}}{A} - \frac{P_{pe}e}{S_x} + \frac{(M_D + M_s)}{S_x} + \frac{(M_{ws} + M_b)}{S_{xy}}$		
Due to permanent loads	$f_{ty} =$	2.000 ksi
		2.000 ksi
$f_{tw} = \frac{P_{pe}}{A} - \frac{P_{pe}e}{S_x} + \frac{(M_D + M_s)}{S_x} + \frac{(M_{ws} + M_b)}{S_{xy}} + \frac{(M_{D,1})}{S_{xy}}$		
Due to permanent loads and transient loads	$f_{tw} =$	2.375 ksi
		2.375 ksi
Compression stresses at top fiber of deck	at midspan	at endspan
$f_w = \frac{(M_{ws} + M_b)}{S_{xy}}$		
Due to permanent loads	$f_{tw} =$	0.054 ksi
		0.054 ksi
$f_{tw} = \frac{(M_{ws} + M_b + M_{D,1})}{S_{xy}}$		
Due to permanent loads and transient loads	$f_{tw} =$	0.627 ksi
		0.627 ksi
Tension stresses at top fiber of deck	at midspan	at endspan
$f_{tw} = \frac{P_{pe}}{A} + \frac{P_{pe}e}{S_x} - \frac{(M_D + M_s)}{S_x} - \frac{(M_{ws} + M_b + 0.8 * M_{D,1})}{S_{xy}}$		
Load Combination Service III	$f_{tb} =$	-1.323 ksi
		-1.323 ksi

NOT OK

OK

OK

OK

OK

**Strength Limit State**

POSITIVE MOMENT SECTION		
$M_u = 1.25DC+1.5DW+1.75(LL+IM)$	$M_u =$	8381.5 ft-kips
effective length factor for compression members		
layer 1	k =	0.11
layer 2	k =	0.26
layer 3	k =	0.31
layer 4	k =	0.31
layer 5	k =	0.29
layer 6	k =	0.29
layer 7	k =	0.29
layer 8	k =	0.29
layer 9	k =	0.28
layer 10	k =	0.28
layer 11	k =	0.28
layer 12	k =	0.28
layer 13	k =	0.28
layer 14	k =	0.28
	c =	4.7 ft-kips

average stress in prestressing steel

layer 1	$f_{ps} =$	103.1 ksi
layer 2	$f_{ps} =$	261.2 ksi
layer 3	$f_{ps} =$	274.9 ksi
layer 4	$f_{ps} =$	274.9 ksi
layer 5	$f_{ps} =$	274.9 ksi
layer 6	$f_{ps} =$	274.9 ksi
layer 7	$f_{ps} =$	274.9 ksi
layer 8	$f_{ps} =$	274.9 ksi
layer 9	$f_{ps} =$	274.9 ksi
layer 10	$f_{ps} =$	274.9 ksi
layer 11	$f_{ps} =$	274.9 ksi
layer 12	$f_{ps} =$	274.9 ksi
layer 13	$f_{ps} =$	274.9 ksi
layer 14	$f_{ps} =$	274.9 ksi

nominal flexure resistance

	a =	4.00 in	
$M_r = \Phi M_n, \Phi = 1.00$	$\Phi M_n =$	8978.2 ft-kips	OK
M=DC+W+LL+IM	M =	5833.6 ft-kips	OK
NEGATIVE MOMENT SECTION			
$M_u = 1.25DC+1.5DW+1.75(LL+IM)$	$M_u =$	4837.2 ft-kips	
	a =	9.12 in	
	$\Phi M_n =$	4766.4 ft-kips	NOT OK
M=DC+W+LL+IM	M =	2869.7 ft-kips	OK

**Shear Design**

CRITICAL SECTION AT 0.59		
$V_u = 1.25DC+1.5DW+1.75(LL+IM)$	$V_u =$	405.0 kips
$M_u = 1.25DC+1.5DW+1.75(LL+IM)$	$M_u =$	-2684.4 ft-kips
or		
$V_u = 1.25DC+1.5DW+1.75(LL+IM)$	$V_u =$	364.8 kips
$M_u = 1.25DC+1.5DW+1.75(LL+IM)$	$M_u =$	-2877.0 ft-kips
max shear	$V_u =$	405.0 kips
max moment	$M_u =$	2877.0 ft-kips
Shear depth	$d_v =$	73.19 in
Applied factored normal force at the section	$N_u =$	0
Angle of diagonal compressive stresses	$\theta =$	36.00 °

**STRAIN IN FLEXURAL TENSION REINFORCEMENT**

$$\epsilon_s = \frac{\frac{M_u}{A_s} + 0.5M_{pc} + 0.5M_s \cot \theta - A_{ps} f_{ps}}{E_s d_s + E_p A_{ps}} \leq 0.002$$

	at midspan	at endspan
resultant compressive stress at centroid $f_{pc} =$	0.586 ksi	0.586 ksi

effective stress in prestressing strand after all losses

	at midspan	at endspan
layer 1 $f_{po} =$	35.7 ksi	35.7 ksi
layer 2 $f_{po} =$	154.1 ksi	154.1 ksi
layer 3 $f_{po} =$	165.1 ksi	165.1 ksi
layer 4 $f_{po} =$	165.1 ksi	165.1 ksi
layer 5 $f_{po} =$	165.1 ksi	
layer 6 $f_{po} =$	165.1 ksi	
layer 7 $f_{po} =$	165.1 ksi	
layer 8 $f_{po} =$	165.1 ksi	
layer 9 $f_{po} =$		165.1 ksi
layer 10 $f_{po} =$		165.1 ksi
layer 11 $f_{po} =$		165.1 ksi
layer 12 $f_{po} =$		165.1 ksi
layer 13 $f_{po} =$		165.1 ksi
layer 14 $f_{po} =$		165.1 ksi

strain in flexural tension

	at midspan	at endspan
layer 1 $\epsilon_x =$	0.002000	0.002000
layer 2 $\epsilon_x =$	0.002000	0.002000
layer 3 $\epsilon_x =$	0.002000	0.002000
layer 4 $\epsilon_x =$	0.002000	0.002000
layer 5 $\epsilon_x =$	0.002000	
layer 6 $\epsilon_x =$	0.002000	
layer 7 $\epsilon_x =$	0.002000	
layer 8 $\epsilon_x =$	0.002000	
layer 9 $\epsilon_x =$		0.002000
layer 10 $\epsilon_x =$		0.002000
layer 11 $\epsilon_x =$		0.002000
layer 12 $\epsilon_x =$		0.002000
layer 13 $\epsilon_x =$		0.002000
layer 14 $\epsilon_x =$		0.002000

**Deflection and Camber**

	at midspan	at endspan
Deflection due to Prestressing Force at Transfer $\Delta_p =$	4.05 in	3.97 in
Deflection due to Beam Self-Weight at Transfer $\Delta_{sw} =$	-2.07 in	
Deflection due to Beam Self-Weight at Erection $\Delta_{sw} =$	-2.24 in	
Deflection due to Haunch and Deck $\Delta_s =$	-3.43 in	

Deflection due to total self weight $\Delta_{sw} =$	-1.62 in
--	----------

Total Deflection at transfer $\Delta =$	1.98 in	1.90 in
Total Deflection at erection $\Delta =$	3.15 in	3.00 in

Live load deflection limit = span/800 $\Delta_c =$	-1.80 in
Deflection due to live load and impact $\Delta_c =$	-1.22 in

OK

Deflection due to fire truck $\Delta_c =$	-2.5431 in
Total Deflection after fire with fire truck $\Delta =$	-0.1090 in

NOT OK

**Parametric Design: Puyallup River Case Study**  
**Beam Design: 3/8" Strand**  
**Fire Exposure Status: Undamaged**

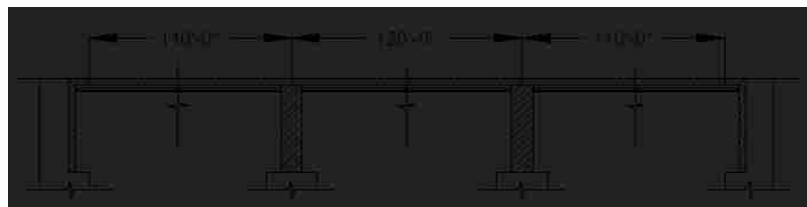
(PCI Bridge Design Manual Section 9.6)



**Material Properties**

CAST-IN-PLACE SLAB		
Actual Thickness	$t_{as} =$	8.0 in
Wearing Surface	$=$	0.5 in
Structural thickness = Actual - Wearing Surface	$t_s =$	7.5 in
Compressive Strength	$f'_c =$	4 ksi
Unit Weight	$w_c =$	150.0 pcf
Stress factor of compression block	$\beta_1 =$	0.85

BEAMS: AASHTO-PCI, BT-72 BULB-TEE		
Strength at release	$f'_{ci} =$	5.5 ksi
Strength at 28 days	$f'_c =$	7 ksi
Unit Weight	$w_c =$	150.0 pcf
Overall Beam Length:		
@ end spans	$L =$	110 ft
@ center span	$L =$	119 ft
Design Spans:		
Non-composite beam @ end spans	$L =$	109 ft
Non-composite beam @ center span	$L =$	118 ft
Composite beam @ end spans	$L =$	110 ft
Composite beam @ center span	$L =$	120 ft
Beam Spacing	$S =$	12 ft



**PRESTRESSING STRANDS**

Diameter of single strand	d =	0.4 in
Area of single strand	A =	0.085 in <sup>2</sup>

Temperature of Layer

layer 1 (bottom)	T =	68.00 °F
layer 2	T =	68.00 °F
layer 3	T =	68.00 °F
layer 4	T =	68.00 °F
layer 5	T =	68.00 °F
layer 6	T =	68.00 °F
layer 7	T =	68.00 °F
layer 8	T =	68.00 °F
layer 9	T =	68.00 °F
layer 10	T =	68.00 °F
layer 11	T =	68.00 °F
layer 12	T =	68.00 °F
layer 13	T =	68.00 °F
layer 14	T =	68.00 °F

Ultimate Strength

initial = 284 ksi

layer 1 (bottom)	f <sub>pu</sub> =	284 ksi
layer 2	f <sub>pu</sub> =	284 ksi
layer 3	f <sub>pu</sub> =	284 ksi
layer 4	f <sub>pu</sub> =	284 ksi
layer 5	f <sub>pu</sub> =	284 ksi
layer 6	f <sub>pu</sub> =	284 ksi
layer 7	f <sub>pu</sub> =	284 ksi
layer 8	f <sub>pu</sub> =	284 ksi
layer 9	f <sub>pu</sub> =	284 ksi
layer 10	f <sub>pu</sub> =	284 ksi
layer 11	f <sub>pu</sub> =	284 ksi
layer 12	f <sub>pu</sub> =	284 ksi
layer 13	f <sub>pu</sub> =	284 ksi
layer 14	f <sub>pu</sub> =	284 ksi

Yield Strength

initial = 257 ksi

layer 1 (bottom)	f <sub>py</sub> =	257 ksi
layer 2	f <sub>py</sub> =	257 ksi
layer 3	f <sub>py</sub> =	257 ksi
layer 4	f <sub>py</sub> =	257 ksi
layer 5	f <sub>py</sub> =	257 ksi
layer 6	f <sub>py</sub> =	257 ksi
layer 7	f <sub>py</sub> =	257 ksi
layer 8	f <sub>py</sub> =	257 ksi
layer 9	f <sub>py</sub> =	257 ksi
layer 10	f <sub>py</sub> =	257 ksi
layer 11	f <sub>py</sub> =	257 ksi
layer 12	f <sub>py</sub> =	257 ksi
layer 13	f <sub>py</sub> =	257 ksi
layer 14	f <sub>py</sub> =	257 ksi

**Stress Limits:**

before transfer ≤ 0.75f<sub>pu</sub> (initial = 202.5)

layer 1 (bottom)	f <sub>pi</sub> =	213.2 ksi
layer 2	f <sub>pi</sub> =	213.2 ksi
layer 3	f <sub>pi</sub> =	213.2 ksi
layer 4	f <sub>pi</sub> =	213.2 ksi
layer 5	f <sub>pi</sub> =	213.2 ksi
layer 6	f <sub>pi</sub> =	213.2 ksi
layer 7	f <sub>pi</sub> =	213.2 ksi
layer 8	f <sub>pi</sub> =	213.2 ksi
layer 9	f <sub>pi</sub> =	213.2 ksi
layer 10	f <sub>pi</sub> =	213.2 ksi
layer 11	f <sub>pi</sub> =	213.2 ksi
layer 12	f <sub>pi</sub> =	213.2 ksi
layer 13	f <sub>pi</sub> =	213.2 ksi
layer 14	f <sub>pi</sub> =	213.2 ksi

at service limit state (after all losses)  $\leq 0.80f_{py}$  (initial = 194.4)

layer 1 (bottom)	$f_{pe} =$	205.4 ksi
layer 2	$f_{pe} =$	205.4 ksi
layer 3	$f_{pe} =$	205.4 ksi
layer 4	$f_{pe} =$	205.4 ksi
layer 5	$f_{pe} =$	205.4 ksi
layer 6	$f_{pe} =$	205.4 ksi
layer 7	$f_{pe} =$	205.4 ksi
layer 8	$f_{pe} =$	205.4 ksi
layer 9	$f_{pe} =$	205.4 ksi
layer 10	$f_{pe} =$	205.4 ksi
layer 11	$f_{pe} =$	205.4 ksi
layer 12	$f_{pe} =$	205.4 ksi
layer 13	$f_{pe} =$	205.4 ksi
layer 14	$f_{pe} =$	205.4 ksi

Modulus of Elasticity

initial = 25898 ksi

layer 1 (bottom)	E =	25898.0 ksi
layer 2	E =	25898.0 ksi
layer 3	E =	25898.0 ksi
layer 4	E =	25898.0 ksi
layer 5	E =	25898.0 ksi
layer 6	E =	25898.0 ksi
layer 7	E =	25898.0 ksi
layer 8	E =	25898.0 ksi
layer 9	E =	25898.0 ksi
layer 10	E =	25898.0 ksi
layer 11	E =	25898.0 ksi
layer 12	E =	25898.0 ksi
layer 13	E =	25898.0 ksi
layer 14	E =	25898.0 ksi

#### REINFORCING BARS

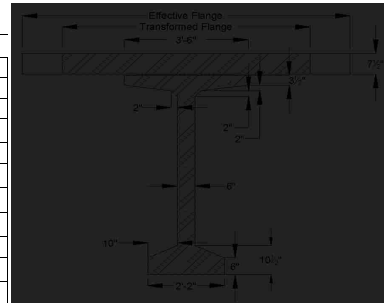
Yield Strength	$f_y =$	57.6 ksi
Modulus of Elasticity	E =	29000.0 ksi

Area of steel at endspan (effective flange)	$A_{se} =$	15.4 in <sup>2</sup>
Area of steel at midspan (effective flange)	$A_{sm} =$	0.0 in <sup>2</sup>
Area of temperature and shrinkage steel (12" width)	$A_s =$	0.0 in <sup>2</sup>

#### Cross-sectional Properties

##### NON-COMPOSITE BEAM

Area of cross-section of beam	A =	767.0 in <sup>2</sup>
Overall depth of beam	H =	72.0 in
Moment of Inertia	I =	527,217 in <sup>4</sup>
Distance from centroid to extreme <b>bottom</b> fiber	$y_b =$	36.6 in
Distance from centroid to extreme <b>top</b> fiber	$y_t =$	35.4 in
Section modulus for the extreme <b>bottom</b> fiber	$S_b =$	14915.0 in <sup>3</sup>
Section modulus for the extreme <b>top</b> fiber	$S_t =$	15421.0 in <sup>3</sup>
Weight	$W_t =$	799.0 plf
Modulus of Elasticity = $33000 \cdot (W_c \cdot 1.5) \cdot (\sqrt{f'_c})$		
cast-in-place concrete deck	$E_{cs} =$	3834 ksi
precast beam at release	$E_{ci} =$	4496 ksi
precast beam at service loads	$E_c =$	5072 ksi



**COMPOSITE BEAM AT MIDSPAN**

Effective Flange Width	$b_f =$	111.0 in	*min of three criteria
Modular Ratio = $E_{cs}/E_c$	$n =$	0.7559	
Transformed flange width	$=$	83.9 in	
Transformed flange area	$=$	629.3 in <sup>2</sup>	
Transformed haunch width	$=$	31.7 in	
Transformed haunch area	$=$	15.9 in <sup>2</sup>	

	Transformed Area	$y_b$	$Ay_b$	$A(y_{bc}-y_b)^2$	I	$I + A(y_{bc}-y_b)^2$
Beam	767.0 in <sup>2</sup>	36.60 in	28,072.2 in <sup>3</sup>	250,443 in <sup>4</sup>	527,217 in <sup>4</sup>	777,660 in <sup>4</sup>
Haunch	15.9 in <sup>2</sup>	72.25 in	1,146.9 in <sup>3</sup>	4,906 in <sup>4</sup>	0.33 in <sup>4</sup>	4,906 in <sup>4</sup>
Deck	629.3 in <sup>2</sup>	76.25 in	47,985.0 in <sup>3</sup>	293,069 in <sup>4</sup>	2,950 in <sup>4</sup>	296,019 in <sup>4</sup>
Total	1412.2 in <sup>2</sup>		77,204.1 in <sup>3</sup>			1,078,585 in <sup>4</sup>

Total area of Composite Section	$A_c =$	1412 in <sup>2</sup>
Overall Depth of the Composite Section	$h_c =$	80 in
Moment of Inertia	$I_c =$	1,078,585 in <sup>4</sup>
Distance from centroid to extreme <u>bottom</u> fiber of beam	$y_{bc} =$	54.67 in
Distance from centroid to extreme <u>top</u> fiber of beam	$y_{tb} =$	17.33 in
Distance from centroid to extreme <u>top</u> fiber of slab	$y_{tc} =$	25.33 in
Section modulus for the extreme <u>bottom</u> fiber of beam	$S_{bc} =$	19,729.0 in <sup>3</sup>
Section modulus for the extreme <u>top</u> fiber of beam	$S_{tb} =$	62,237.8 in <sup>3</sup>
Section modulus for the extreme <u>top</u> fiber slab	$S_{tc} =$	56,329.7 in <sup>3</sup>

**Shear Forces and Bending Moments**

**DEAD LOADS**

Beam self-weight	$w_{beam} =$	0.799 k/f
8 in. deck weight	$w_{deck} =$	1.200 k/f
1/2 in. haunch weight	$w_{haunch} =$	0.022 k/f

LRFD Specifications: Art. 4.6.2.2.1		
Width of Deck Constant		OK
Number of beams is not less than four $N_b =$	4	OK
Roadway part of the overhang, $d_e \leq 3.0$ ft, $d_e =$	1.5	OK
Curvature in plans is less than $4^\circ =$	0	OK
Cross-section of the bridge is consistent with one of the cross sections given by LRFD specs		OK

Barrier and wearing surface loads are equally distributed among the 4 beams

Barrier Wt	$Wt =$	0.150 k/f
Dead load of future wearing surface	$DW =$	0.263 k/f

**LIVE LOADS**

Fire truck live load front load (Point A)	$P_{live} =$	48.0 kips
Fire truck live load back load (Point B)	$P_{live} =$	22.0 kips
distance between two loads		19.2 ft
distance from nearest edge to point A	$x_a =$	59.0 ft
distance from nearest edge to point B	$x_b =$	39.8 ft

LRFD Specifications: Art. 4.6.2.2.1		
Width of Deck Constant		OK
Number of beams is not less than four $N_b =$	4	OK
Beams are parallel and approximately of the same stiffness		OK
Roadway part of the overhang, $d_e \leq 3.0$ ft, $d_e =$	1.5	OK
Curvature in plans is less than $4^\circ =$	0	OK

Barrier and wearing surface loads are equally distributed among the 4 beams

Bridge Type-- "k" (LRFD Table 4.6.2.2.1-1)		
Number of design lanes = $w/12$	$=$	3 lanes

**Distribution Factor for Bending Moment:**

Beams spacing	S =	12.0 ft
Depth of concrete slab	t <sub>s</sub> =	7.5 in
Beam Span	L =	120.0 ft
Number of Beams	N <sub>b</sub> =	4
Modular ratio between beam & deck materials	n =	1.3229
Longitudinal stiffness parameter	K <sub>y</sub> =	2,292,589.53 in <sup>4</sup>

at center span:

$$DFM = 0.75 + \left(\frac{S}{9.5}\right)^{0.4} * \left(\frac{S}{L}\right)^{0.3} * \left(\frac{K_y}{12 * L * t_s^3}\right)^{0.1}$$

DFM =	0.904 lanes/beam
-------	------------------

one design lane loaded:

$$DFM = 0.75 + \left(\frac{S}{14}\right)^{0.4} * \left(\frac{S}{L}\right)^{0.3} * \left(\frac{K_y}{12 * L * t_s^3}\right)^{0.1}$$

DFM =	0.613 lanes/beam
-------	------------------

0.905 Controls

**Distribution Factor for Shear Force**

both end spans and center span:

$$DFV = 0.2 + \left(\frac{S'}{12}\right) - \left(\frac{S'}{35}\right)^2$$

DFV =	1.082 lanes/beam
-------	------------------

one design lane loaded:

$$DFV = 0.36 + \left(\frac{S'}{25}\right)$$

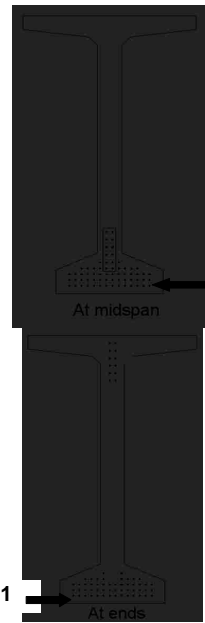
DFV =	0.840 lanes/beam
-------	------------------

1.082 Controls

from bottom	At Midspan		At Ends	
	No. of	Distance from Bottom	No. of	Distance from Bottom
layer 1	14	2	14	2
layer 2	14	3.5	14	3.5
layer 3	14	5	14	5
layer 4	10	6.5	8	6.5
layer 5	4	8	2	8
layer 6	2	10	-	-
layer 7	2	12	-	-
layer 8	2	14	-	-
layer 9	2	16	2	60
layer 10	-	-	2	62
layer 11	-	-	2	64
layer 12	-	-	2	66
layer 13	-	-	2	68
layer 14	-	-	2	70
	64		64	
<b>Harped Strand Group (included in above totals)</b>				
layer 3	2	6		
layer 4	2	8		
layer 5	2	10		
layer 6	2	12		
layer 7	2	14		
layer 8	2	16		

distance from the center of gravity of strands to the bottom fiber of the beam = 7% of the beam depth  
strand eccentricity at midspan = (y<sub>c</sub> - y<sub>bs</sub>)

y <sub>bs</sub> =	5.44 in
e <sub>c</sub> =	31.16 in



layer 1



**Prestress Losses**

**ELASTIC SHORTENING**

assumed loss	=	6.00%
Force per strand at transfer		
layer 1	=	17.0 kips
layer 2	=	17.0 kips
layer 3	=	17.0 kips
layer 4	=	17.0 kips
layer 5	=	17.0 kips
layer 6	=	17.0 kips
layer 7	=	17.0 kips
layer 8	=	17.0 kips
layer 9	=	17.0 kips
layer 10	=	17.0 kips
layer 11	=	17.0 kips
layer 12	=	17.0 kips
layer 13	=	17.0 kips
layer 14	=	17.0 kips

Total prestressing force at release	$P_i =$	at midspan 1088.0 kips	at endspan 1054.0 kips
Sum of concrete stresses at the center of gravity of prestressing tendons due to prestressing force at transfer and the self-weight of the member at sections of maximum moment	$f_{cgp} =$	2.436 ksi	2.329 ksi
Loss due to shortening		at midspan	at endspan
layer 1	$\Delta f_{pES} =$	14.0 ksi	13.4 ksi
layer 2	$\Delta f_{pES} =$	14.0 ksi	13.4 ksi
layer 3	$\Delta f_{pES} =$	14.0 ksi	13.4 ksi
layer 4	$\Delta f_{pES} =$	14.0 ksi	13.4 ksi
layer 5	$\Delta f_{pES} =$	14.0 ksi	13.4 ksi
layer 6	$\Delta f_{pES} =$	14.0 ksi	
layer 7	$\Delta f_{pES} =$	14.0 ksi	
layer 8	$\Delta f_{pES} =$	14.0 ksi	
layer 9	$\Delta f_{pES} =$	14.0 ksi	13.4 ksi
layer 10	$\Delta f_{pES} =$		13.4 ksi
layer 11	$\Delta f_{pES} =$		13.4 ksi
layer 12	$\Delta f_{pES} =$		13.4 ksi
layer 13	$\Delta f_{pES} =$		13.4 ksi
layer 14	$\Delta f_{pES} =$		13.4 ksi

**SHRINKAGE**

Shrinkage = (17-0.15*Relative Humidity)	$\Delta f_{pSR} =$	6.5 ksi	← assume relative humidity = 70%
---	--------------------	---------	----------------------------------

**CREEP OF CONCRETE**

Change of stresses at center of gravity of prestressing force due to permanent loads except the loads acting at time of applying prestressing force, calculated at the same section as $f_{cgp}$	$\Delta f_{csp} =$	1.619 ksi	
loss due to creep		at midspan	at endspan
	$\Delta f_{pCR} =$	17.9 ksi	16.6 ksi

**RELAXATION OF PRESTRESSING STRANDS**

loss due to relaxation after transfer		at midspan	at endspan
layer 1	$\Delta f_{pR2} =$	2.9 ksi	2.9 ksi
layer 2	$\Delta f_{pR2} =$	2.9 ksi	2.9 ksi
layer 3	$\Delta f_{pR2} =$	2.9 ksi	2.9 ksi
layer 4	$\Delta f_{pR2} =$	2.9 ksi	2.9 ksi
layer 5	$\Delta f_{pR2} =$	2.9 ksi	2.9 ksi
layer 6	$\Delta f_{pR2} =$	2.9 ksi	
layer 7	$\Delta f_{pR2} =$	2.9 ksi	
layer 8	$\Delta f_{pR2} =$	2.9 ksi	
layer 9	$\Delta f_{pR2} =$	2.9 ksi	2.9 ksi
layer 10	$\Delta f_{pR2} =$		2.9 ksi
layer 11	$\Delta f_{pR2} =$		2.9 ksi
layer 12	$\Delta f_{pR2} =$		2.9 ksi
layer 13	$\Delta f_{pR2} =$		2.9 ksi
layer 14	$\Delta f_{pR2} =$		2.9 ksi

**TOTAL LOSSES AT TRANSFER**

total loss  $\Delta f_{pES} = \Delta f_{pt}$

stress in tendons after transfer  $f_{pt} = f_{pi} - \Delta f_{pt}$

		at midspan	at endspan
layer 1	$f_{pt} =$	199.1 ksi	199.7 ksi
layer 2	$f_{pt} =$	199.1 ksi	199.7 ksi
layer 3	$f_{pt} =$	199.1 ksi	199.7 ksi
layer 4	$f_{pt} =$	199.1 ksi	199.7 ksi
layer 5	$f_{pt} =$	199.1 ksi	199.7 ksi
layer 6	$f_{pt} =$	199.1 ksi	
layer 7	$f_{pt} =$	199.1 ksi	
layer 8	$f_{pt} =$	199.1 ksi	
layer 9	$f_{pt} =$	199.1 ksi	199.7 ksi
layer 10	$f_{pt} =$		199.7 ksi
layer 11	$f_{pt} =$		199.7 ksi
layer 12	$f_{pt} =$		199.7 ksi
layer 13	$f_{pt} =$		199.7 ksi
layer 14	$f_{pt} =$		199.7 ksi

force per strand =  $f_{pt}$  \* strand area

		at midspan	at endspan
layer 1	=	16.9 kips	17.0 kips
layer 2	=	16.9 kips	17.0 kips
layer 3	=	16.9 kips	17.0 kips
layer 4	=	16.9 kips	17.0 kips
layer 5	=	16.9 kips	17.0 kips
layer 6	=	16.9 kips	
layer 7	=	16.9 kips	
layer 8	=	16.9 kips	
layer 9	=	16.9 kips	17.0 kips
layer 10	=		17.0 kips
layer 11	=		17.0 kips
layer 12	=		17.0 kips
layer 13	=		17.0 kips
layer 14	=		17.0 kips
Total prestressing force after transfer	$P_t =$	1047.8 kips	1054.0 kips

Initial loss =  $(\Delta f_{pi}) / (f_{pi})$

		at midspan	at endspan
layer 1	% =	6.6%	6.3%
layer 2	% =	6.6%	6.3%
layer 3	% =	6.6%	6.3%
layer 4	% =	6.6%	6.3%
layer 5	% =	6.6%	6.3%
layer 6	% =	6.6%	
layer 7	% =	6.6%	
layer 8	% =	6.6%	
layer 9	% =	6.6%	6.3%
layer 10	% =		6.3%
layer 11	% =		6.3%
layer 12	% =		6.3%
layer 13	% =		6.3%
layer 14	% =		6.3%

OK  
OK  
OK  
OK  
OK  
OK  
OK  
OK  
OK  
OK  
OK  
OK  
OK  
OK

**TOTAL LOSSES AT SERVICE LOADS**

Total Losses

		at midspan	at endspan
layer 1	$\Delta f_{pT} =$	41.3 ksi	40.7 ksi
layer 2	$\Delta f_{pT} =$	41.3 ksi	40.7 ksi
layer 3	$\Delta f_{pT} =$	41.3 ksi	40.7 ksi
layer 4	$\Delta f_{pT} =$	41.3 ksi	40.7 ksi
layer 5	$\Delta f_{pT} =$	41.3 ksi	40.7 ksi
layer 6	$\Delta f_{pT} =$	41.3 ksi	
layer 7	$\Delta f_{pT} =$	41.3 ksi	
layer 8	$\Delta f_{pT} =$	41.3 ksi	
layer 9	$\Delta f_{pT} =$	41.3 ksi	40.7 ksi
layer 10	$\Delta f_{pT} =$		40.7 ksi
layer 11	$\Delta f_{pT} =$		40.7 ksi
layer 12	$\Delta f_{pT} =$		40.7 ksi
layer 13	$\Delta f_{pT} =$		40.7 ksi
layer 14	$\Delta f_{pT} =$		40.7 ksi

Stress in tendon after all losses =  $f_{pt} - \Delta f_{pt}$

		at midspan	at endspan
layer 1	$f_{pe} =$	171.9 ksi	172.5 ksi
layer 2	$f_{pe} =$	171.9 ksi	172.5 ksi
layer 3	$f_{pe} =$	171.9 ksi	172.5 ksi
layer 4	$f_{pe} =$	171.9 ksi	172.5 ksi
layer 5	$f_{pe} =$	171.9 ksi	172.5 ksi
layer 6	$f_{pe} =$	171.9 ksi	
layer 7	$f_{pe} =$	171.9 ksi	
layer 8	$f_{pe} =$	171.9 ksi	
layer 9	$f_{pe} =$	171.9 ksi	172.5 ksi
layer 10	$f_{pe} =$		172.5 ksi
layer 11	$f_{pe} =$		172.5 ksi
layer 12	$f_{pe} =$		172.5 ksi
layer 13	$f_{pe} =$		172.5 ksi
layer 14	$f_{pe} =$		172.5 ksi

check prestressing stress limit at service limit state:  $f_{pe} \leq 0.8 \cdot f_{py}$

layer 1	=	205.4 ksi
layer 2	=	205.4 ksi
layer 3	=	205.4 ksi
layer 4	=	205.4 ksi
layer 5	=	205.4 ksi
layer 6	=	205.4 ksi
layer 7	=	205.4 ksi
layer 8	=	205.4 ksi
layer 9	=	205.4 ksi
layer 10	=	205.4 ksi
layer 11	=	205.4 ksi
layer 12	=	205.4 ksi
layer 13	=	205.4 ksi
layer 14	=	205.4 ksi

OK  
OK  
OK  
OK  
OK  
OK  
OK  
OK  
OK  
OK  
OK  
OK  
OK

force per strand =  $f_{pe} \cdot \text{strand area}$

		at midspan	at endspan
layer 1	=	14.6 kips	14.7 kips
layer 2	=	14.6 kips	14.7 kips
layer 3	=	14.6 kips	14.7 kips
layer 4	=	14.6 kips	14.7 kips
layer 5	=	14.6 kips	14.7 kips
layer 6	=	14.6 kips	
layer 7	=	14.6 kips	
layer 8	=	14.6 kips	
layer 9	=	14.6 kips	14.7 kips
layer 10	=		14.7 kips
layer 11	=		14.7 kips
layer 12	=		14.7 kips
layer 13	=		14.7 kips
layer 14	=		14.7 kips

Total prestressing force after all losses

		at midspan	at endspan
$P_{pe} =$		934.9 kips	938.3 kips

Final losses, % =  $(\Delta f_{pt}) / (f_{pi})$

layer 1	% =	19.4%	19.1%
layer 2	% =	19.4%	19.1%
layer 3	% =	19.4%	19.1%
layer 4	% =	19.4%	19.1%
layer 5	% =	19.4%	19.1%
layer 6	% =	19.4%	
layer 7	% =	19.4%	
layer 8	% =	19.4%	
layer 9	% =	19.4%	19.1%
layer 10	% =		19.1%
layer 11	% =		19.1%
layer 12	% =		19.1%
layer 13	% =		19.1%
layer 14	% =		19.1%
Average final losses, %	% =	19.4%	19.1%

### Stresses at Transfer

#### STRESS LIMITS FOR CONCRETE

Compression = $0.6f_{ci}$	$f_{ci} =$	3.300 ksi
Tension		
without bonded reinforcement = $-0.0948\sqrt{f_{ci}} \leq -0.2$	=	-0.200 ksi
with bonded auxiliary reinforcement = $-0.22\sqrt{f_{ci}}$	=	-0.016 ksi

#### STRESSES AT TRANSFER LENGTH SECTION

Transfer Length = $60 \times$ (strand diameter)	=	1.9 ft	} Calcs for eccentricity (see 9.6.7.2)
Bending moment at transfer length	$M_g =$	87.7 ft-kips	
center of 12 strands to top fiber of beam at the end	=	7.00 in	
center of 12 strands to bottom fiber of beam at the harp point	=	11.00 in	
center of 12 strands and top fiber of beam at transfer length	=	9.84 in	
center of gravity of 32 strands and bottom fiber of beam	=	3.98 in	
center of gravity of all strands and the bottom fiber of beam at transfer length	=	15.24 in	
center of gravity of all strands and the bottom fiber of beam at the end	=	15.30 in	
Eccentricity of the strand group at transfer length:	$e_n =$	21.36 in	
Eccentricity at end of beam:	$e =$	21.30 in	

$$f_t = \frac{P_i}{A} - \frac{P_i e}{S_t} + \frac{M_g}{S_t}$$

$$f_b = \frac{P_i}{A} + \frac{P_i e}{S_b} - \frac{M_g}{S_b}$$

		at midspan	at endspan	
Top stress at top fiber of beam	$f_t =$	-0.017 ksi	-0.017 ksi	OK
Bottom stress at bottom fiber of the beam	$f_b =$	2.906 ksi	2.906 ksi	OK

#### STRESSES AT HARP POINT

Bending moment due to beam weight at 0.3L	$M_g =$	1188.0 ft-kips		
Top stress at top fiber of beam	$f_t =$	0.173 ksi	0.169 ksi	OK
Bottom stress at bottom fiber of the beam	$f_b =$	2.736 ksi	2.621 ksi	OK

#### STRESSES AT MIDSPAN

Bending moment due to beam weight at 0.5L	$M_g =$	1414.3 ft-kips		
Top stress at top fiber of beam	$f_t =$	0.320 ksi	0.345 ksi	OK
Bottom stress at bottom fiber of the beam	$f_b =$	2.554 ksi	2.438 ksi	OK

#### HOLD-DOWN FORCES

assume stress in strand before losses =  $0.8f_u$

layer 1	=	227.4 ksi
layer 2	=	227.4 ksi
layer 3	=	227.4 ksi
layer 4	=	227.4 ksi
layer 5	=	227.4 ksi
layer 6	=	227.4 ksi
layer 7	=	227.4 ksi
layer 8	=	227.4 ksi
layer 9	=	227.4 ksi
layer 10	=	227.4 ksi
layer 11	=	227.4 ksi
layer 12	=	227.4 ksi
layer 13	=	227.4 ksi
layer 14	=	227.4 ksi

prestressing force per strand before any losses:

layer 1	=	19.3 kips
layer 2	=	19.3 kips
layer 3	=	19.3 kips
layer 4	=	19.3 kips
layer 5	=	19.3 kips
layer 6	=	19.3 kips
layer 7	=	19.3 kips
layer 8	=	19.3 kips
layer 9	=	19.3 kips
layer 10	=	19.3 kips
layer 11	=	19.3 kips
layer 12	=	19.3 kips
layer 13	=	19.3 kips
layer 14	=	19.3 kips
Harp Angle	$\psi =$	7.2 °

Hold-down force/strand

layer 1	=	2.5 kips/strand
layer 2	=	2.5 kips/strand
layer 3	=	2.5 kips/strand
layer 4	=	2.5 kips/strand
layer 5	=	2.5 kips/strand
layer 6	=	2.5 kips/strand
layer 7	=	2.5 kips/strand
layer 8	=	2.5 kips/strand
layer 9	=	2.5 kips/strand
layer 10	=	2.5 kips/strand
layer 11	=	2.5 kips/strand
layer 12	=	2.5 kips/strand
layer 13	=	2.5 kips/strand
layer 14	=	2.5 kips/strand
Total hold-down force	=	30.45 kips

**Stresses at Service Loads**

**STRESS LIMITS FOR CONCRETE**

Compression:

Due to permanent loads for load combination Service I

for the precast beam	=	3.150 ksi
for deck	=	1.800 ksi

Due to permanent and transient loads for load combination Service I

for the precast beam	=	4.200 ksi
for deck	=	2.400 ksi

Tension:

Load Combination Service III

for the precast beam	=	-0.016 ksi
----------------------	---	------------

**STRESSES AT MIDSPAN**

Compression stresses at top fiber of beam	at midspan	at endspan	
$f_t = \frac{P_{ps}}{A} - \frac{P_{ps}e}{S_t} + \frac{(M_D + M_{L1})}{S_t} + \frac{(M_{L2} + M_D)}{S_{tr}}$			
Due to permanent loads	$f_{t1} =$	2.106 ksi	2.103 ksi
$f_{tr} = \frac{P_{ps}}{A} - \frac{P_{ps}e}{S_t} + \frac{(M_D + M_{L1})}{S_t} + \frac{(M_{L2} + M_D)}{S_{tr}} + \frac{(M_{LL1})}{S_{tr}}$			
Due to permanent loads and transient loads	$f_{t2} =$	2.513 ksi	2.511 ksi
Compression stresses at top fiber of deck	at midspan	at endspan	
$f_{tr} = \frac{(M_{L2} + M_D)}{S_{tr}}$			
Due to permanent loads	$f_{t3} =$	0.043 ksi	0.043 ksi
$f_{tr} = \frac{(M_{L2} + M_D + M_{LL1})}{S_{tr}}$			
Due to permanent loads and transient loads	$f_{t4} =$	0.493 ksi	0.493 ksi
Tension stresses at top fiber of deck	at midspan	at endspan	
$f_{tr} = \frac{P_{ps}}{A} + \frac{P_{ps}e}{S_b} - \frac{(M_D + M_{L1})}{S_b} - \frac{(M_{L2} + M_D + 0.8 * M_{LL1})}{S_{tr}}$			
Load Combination Service III	$f_{t5} =$	-0.809 ksi	-0.798 ksi

OK

OK

OK

OK

OK

**Strength Limit State**

POSITIVE MOMENT SECTION		
$M_u = 1.25DC+1.5DW+1.75(LL+IM)$	$M_u =$	8381.5 ft-kips
effective length factor for compression members		
layer 1	k =	0.27
layer 2	k =	0.27
layer 3	k =	0.27
layer 4	k =	0.27
layer 5	k =	0.27
layer 6	k =	0.27
layer 7	k =	0.27
layer 8	k =	0.27
layer 9	k =	0.27
layer 10	k =	0.27
layer 11	k =	0.27
layer 12	k =	0.27
layer 13	k =	0.27
layer 14	k =	0.27
	c =	4.6 ft-kips

average stress in prestressing steel

layer 1	$f_{ps} =$	279.4 ksi
layer 2	$f_{ps} =$	279.4 ksi
layer 3	$f_{ps} =$	279.4 ksi
layer 4	$f_{ps} =$	279.4 ksi
layer 5	$f_{ps} =$	279.4 ksi
layer 6	$f_{ps} =$	279.4 ksi
layer 7	$f_{ps} =$	279.4 ksi
layer 8	$f_{ps} =$	279.4 ksi
layer 9	$f_{ps} =$	279.4 ksi
layer 10	$f_{ps} =$	279.4 ksi
layer 11	$f_{ps} =$	279.4 ksi
layer 12	$f_{ps} =$	279.4 ksi
layer 13	$f_{ps} =$	279.4 ksi
layer 14	$f_{ps} =$	279.4 ksi

nominal flexure resistance

	a =	3.94 in	
$M_r = \Phi M_n, \Phi = 1.00$	$\Phi M_n =$	9193.8 ft-kips	OK
M=DC+W+LL+IM	M =	5833.6 ft-kips	OK
NEGATIVE MOMENT SECTION			
$M_u = 1.25DC+1.5DW+1.75(LL+IM)$	$M_u =$	4837.2 ft-kips	
	a =	5.73 in	
	$\Phi M_n =$	4879.0 ft-kips	OK
M=DC+W+LL+IM	M =	2869.7 ft-kips	OK

**Shear Design**

CRITICAL SECTION AT 0.59		
$V_u = 1.25DC+1.5DW+1.75(LL+IM)$	$V_u =$	405.0 kips
$M_u = 1.25DC+1.5DW+1.75(LL+IM)$	$M_u =$	-2684.4 ft-kips
or		
$V_u = 1.25DC+1.5DW+1.75(LL+IM)$	$V_u =$	364.8 kips
$M_u = 1.25DC+1.5DW+1.75(LL+IM)$	$M_u =$	-2877.0 ft-kips
max shear	$V_u =$	405.0 kips
max moment	$M_u =$	2877.0 ft-kips
Shear depth	$d_v =$	73.19 in
Applied factored normal force at the section	$N_u =$	0
Angle of diagonal compressive stresses	$\theta =$	36.00 °

**STRAIN IN FLEXURAL TENSION REINFORCEMENT**

$$\epsilon_t = \frac{\frac{M}{S_x} + 0.5N_u + 0.5V_u \cot \theta + A_{ps} f_{ps}}{E_c A_g + E_p A_{ps}} \leq 0.002$$

resultant compressive stress at centroid

	at midspan	at endspan
$f_{pc} =$	0.901 ksi	0.903 ksi

effective stress in prestressing strand after all losses

	at midspan	at endspan
layer 1	$f_{po} =$ 176.5 ksi	177.1 ksi
layer 2	$f_{po} =$ 176.5 ksi	177.1 ksi
layer 3	$f_{po} =$ 176.5 ksi	177.1 ksi
layer 4	$f_{po} =$ 176.5 ksi	177.1 ksi
layer 5	$f_{po} =$ 176.5 ksi	
layer 6	$f_{po} =$ 176.5 ksi	
layer 7	$f_{po} =$ 176.5 ksi	
layer 8	$f_{po} =$ 176.5 ksi	
layer 9	$f_{po} =$	177.1 ksi
layer 10	$f_{po} =$	177.1 ksi
layer 11	$f_{po} =$	177.1 ksi
layer 12	$f_{po} =$	177.1 ksi
layer 13	$f_{po} =$	177.1 ksi
layer 14	$f_{po} =$	177.1 ksi

strain in flexural tension

	at midspan	at endspan
layer 1	$\epsilon_x =$ 0.002000	0.002000
layer 2	$\epsilon_x =$ 0.002000	0.002000
layer 3	$\epsilon_x =$ 0.002000	0.002000
layer 4	$\epsilon_x =$ 0.002000	0.002000
layer 5	$\epsilon_x =$ 0.002000	
layer 6	$\epsilon_x =$ 0.002000	
layer 7	$\epsilon_x =$ 0.002000	
layer 8	$\epsilon_x =$ 0.002000	
layer 9	$\epsilon_x =$	0.002000
layer 10	$\epsilon_x =$	0.002000
layer 11	$\epsilon_x =$	0.002000
layer 12	$\epsilon_x =$	0.002000
layer 13	$\epsilon_x =$	0.002000
layer 14	$\epsilon_x =$	0.002000

**Deflection and Camber**

Deflection due to Prestressing Force at Transfer

	at midspan	at endspan
$\Delta_p =$	3.35 in	3.37 in

Deflection due to Beam Self-Weight at Transfer

$\Delta_{sw} =$	-1.52 in	
-----------------	----------	--

Deflection due to Beam Self-Weight at Erection

$\Delta_{sw} =$	-1.30 in	
-----------------	----------	--

Deflection due to Haunch and Deck

$\Delta_s =$	-1.99 in	
--------------	----------	--

Deflection due to total self weight

$\Delta_{sw} =$	0.06 in	
-----------------	---------	--

Total Deflection at transfer

$\Delta =$	1.83 in	1.85 in
------------	---------	---------

Total Deflection at erection

$\Delta =$	3.62 in	3.66 in
------------	---------	---------

Live load deflection limit = span/800

$\Delta_L =$	-1.80 in	
--------------	----------	--

Deflection due to live load and impact

$\Delta_L =$	-0.80 in	
--------------	----------	--

OK

Deflection due to fire truck

$\Delta_L =$	-1.4796 in	
--------------	------------	--

OK

Total Deflection after fire with fire truck

$\Delta =$	1.9287 in	
------------	-----------	--

**Parametric Design: Puyallup River Case Study**  
**Beam Design: 3/8" Strand**  
**Fire Exposure Status: 1 Hour**

(PCI Bridge Design Manual Section 9.6)

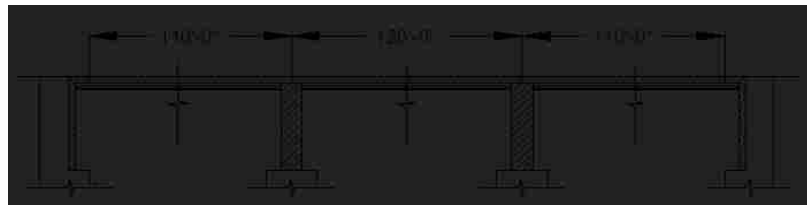


**Material Properties**

CAST-IN-PLACE SLAB		
Actual Thickness	$t_{as} =$	8.0 in
Wearing Surface	$=$	0.5 in
Structural thickness = Actual - Wearing Surface	$t_s =$	7.5 in
Compressive Strength	$f'_c =$	4 ksi
Unit Weight	$w_c =$	150.0 pcf
Stress factor of compression block	$\beta_1 =$	0.85

BEAMS: AASHTO-PCI, BT-72 BULB-TEE		
Strength at release	$f'_{ci} =$	5.5 ksi
Strength at 28 days	$f'_c =$	5.02 ksi
Unit Weight	$w_c =$	150.0 pcf
Overall Beam Length:		
@ end spans	$L =$	110 ft
@ center span	$L =$	119 ft
Design Spans:		
Non-composite beam @ end spans	$L =$	109 ft
Non-composite beam @ center span	$L =$	118 ft
Composite beam @ end spans	$L =$	110 ft
Composite beam @ center span	$L =$	120 ft
Beam Spacing	$S =$	12 ft





**PRESTRESSING STRANDS**

Diameter of single strand	d =	0.4 in
Area of single strand	A =	0.085 in <sup>2</sup>

Temperature of Layer

layer 1 (bottom)	T =	1150.00 °F
layer 2	T =	340.00 °F
layer 3	T =	100.00 °F
layer 4	T =	68.00 °F
layer 5	T =	68.00 °F
layer 6	T =	68.00 °F
layer 7	T =	68.00 °F
layer 8	T =	68.00 °F
layer 9	T =	68.00 °F
layer 10	T =	68.00 °F
layer 11	T =	68.00 °F
layer 12	T =	68.00 °F
layer 13	T =	68.00 °F
layer 14	T =	68.00 °F

Ultimate Strength

initial = 284 ksi

layer 1 (bottom)	f <sub>pu</sub> =	139 ksi
layer 2	f <sub>pu</sub> =	281 ksi
layer 3	f <sub>pu</sub> =	284 ksi
layer 4	f <sub>pu</sub> =	284 ksi
layer 5	f <sub>pu</sub> =	284 ksi
layer 6	f <sub>pu</sub> =	284 ksi
layer 7	f <sub>pu</sub> =	284 ksi
layer 8	f <sub>pu</sub> =	284 ksi
layer 9	f <sub>pu</sub> =	284 ksi
layer 10	f <sub>pu</sub> =	284 ksi
layer 11	f <sub>pu</sub> =	284 ksi
layer 12	f <sub>pu</sub> =	284 ksi
layer 13	f <sub>pu</sub> =	284 ksi
layer 14	f <sub>pu</sub> =	284 ksi

Yield Strength

initial = 257 ksi

layer 1 (bottom)	f <sub>py</sub> =	139 ksi
layer 2	f <sub>py</sub> =	247 ksi
layer 3	f <sub>py</sub> =	254 ksi
layer 4	f <sub>py</sub> =	257 ksi
layer 5	f <sub>py</sub> =	257 ksi
layer 6	f <sub>py</sub> =	257 ksi
layer 7	f <sub>py</sub> =	257 ksi
layer 8	f <sub>py</sub> =	257 ksi
layer 9	f <sub>py</sub> =	257 ksi
layer 10	f <sub>py</sub> =	257 ksi
layer 11	f <sub>py</sub> =	257 ksi
layer 12	f <sub>py</sub> =	257 ksi
layer 13	f <sub>py</sub> =	257 ksi
layer 14	f <sub>py</sub> =	257 ksi

**Stress Limits:**

before transfer ≤ 0.75f<sub>pu</sub> (initial = 202.5)

layer 1 (bottom)	f <sub>di</sub> =	104.4 ksi
layer 2	f <sub>di</sub> =	211.0 ksi
layer 3	f <sub>di</sub> =	213.2 ksi
layer 4	f <sub>di</sub> =	213.2 ksi
layer 5	f <sub>di</sub> =	213.2 ksi
layer 6	f <sub>di</sub> =	213.2 ksi
layer 7	f <sub>di</sub> =	213.2 ksi
layer 8	f <sub>di</sub> =	213.2 ksi
layer 9	f <sub>di</sub> =	213.2 ksi
layer 10	f <sub>di</sub> =	213.2 ksi
layer 11	f <sub>di</sub> =	213.2 ksi
layer 12	f <sub>di</sub> =	213.2 ksi
layer 13	f <sub>di</sub> =	213.2 ksi
layer 14	f <sub>di</sub> =	213.2 ksi

at service limit state (after all losses)  $\leq 0.80f_{py}$  (initial = 194.4)

layer 1 (bottom)	$f_{pe} =$	110.9 ksi
layer 2	$f_{pe} =$	197.2 ksi
layer 3	$f_{pe} =$	203.4 ksi
layer 4	$f_{pe} =$	205.4 ksi
layer 5	$f_{pe} =$	205.4 ksi
layer 6	$f_{pe} =$	205.4 ksi
layer 7	$f_{pe} =$	205.4 ksi
layer 8	$f_{pe} =$	205.4 ksi
layer 9	$f_{pe} =$	205.4 ksi
layer 10	$f_{pe} =$	205.4 ksi
layer 11	$f_{pe} =$	205.4 ksi
layer 12	$f_{pe} =$	205.4 ksi
layer 13	$f_{pe} =$	205.4 ksi
layer 14	$f_{pe} =$	205.4 ksi

Modulus of Elasticity

initial = 25898 ksi

layer 1 (bottom)	$E =$	25898.0 ksi
layer 2	$E =$	27192.9 ksi
layer 3	$E =$	25898.0 ksi
layer 4	$E =$	25898.0 ksi
layer 5	$E =$	25898.0 ksi
layer 6	$E =$	25898.0 ksi
layer 7	$E =$	25898.0 ksi
layer 8	$E =$	25898.0 ksi
layer 9	$E =$	25898.0 ksi
layer 10	$E =$	25898.0 ksi
layer 11	$E =$	25898.0 ksi
layer 12	$E =$	25898.0 ksi
layer 13	$E =$	25898.0 ksi
layer 14	$E =$	25898.0 ksi

#### REINFORCING BARS

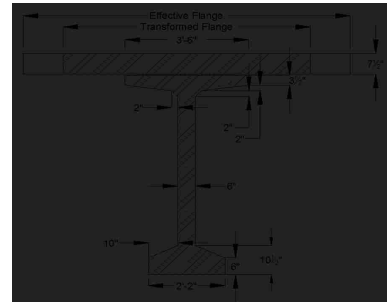
Yield Strength	$f_y =$	57.6 ksi
Modulus of Elasticity	$E =$	29000.0 ksi

Area of steel at endspan (effective flange)	$A_{se} =$	15.4 in <sup>2</sup>
Area of steel at midspan (effective flange)	$A_{sm} =$	0.0 in <sup>2</sup>
Area of temperature and shrinkage steel (12" width)	$A_s =$	0.0 in <sup>2</sup>

#### Cross-sectional Properties

##### NON-COMPOSITE BEAM

Area of cross-section of beam	$A =$	767.0 in <sup>2</sup>
Overall depth of beam	$H =$	72.0 in
Moment of Inertia	$I =$	411,881 in <sup>4</sup>
Distance from centroid to extreme <b>bottom</b> fiber	$y_b =$	40.3 in
Distance from centroid to extreme <b>top</b> fiber	$y_t =$	31.7 in
Section modulus for the extreme <b>bottom</b> fiber	$S_b =$	14915.0 in <sup>3</sup>
Section modulus for the extreme <b>top</b> fiber	$S_t =$	15421.0 in <sup>3</sup>
Weight	$W_1 =$	799.0 plf
Modulus of Elasticity = $33000 \cdot (W_c \cdot 1.5)^{1/3} \cdot \sqrt{f_c}$		
cast-in-place concrete deck	$E_{cs} =$	3834 ksi
precast beam at release	$E_{ci} =$	4496 ksi
precast beam at service loads	$E_c =$	4295 ksi



**COMPOSITE BEAM AT MIDSPAN**

Effective Flange Width	$b_f =$	111.0 in	*min of three criteria
Modular Ratio = $E_{cs}/E_c$	$n =$	0.8926	
Transformed flange width	$=$	99.1 in	
Transformed flange area	$=$	743.1 in <sup>2</sup>	
Transformed haunch width	$=$	37.5 in	
Transformed haunch area	$=$	18.7 in <sup>2</sup>	

	Transformed Area	$y_b$	$Ay_b$	$A(y_{bc}-y_b)^2$	I	$I + A(y_{bc}-y_b)^2$
Beam	767.0 in <sup>2</sup>	40.31 in	30,917.8 in <sup>3</sup>	244,676 in <sup>4</sup>	411,881 in <sup>4</sup>	656,557 in <sup>4</sup>
Haunch	18.7 in <sup>2</sup>	72.25 in	1,354.4 in <sup>3</sup>	3,716 in <sup>4</sup>	0.33 in <sup>4</sup>	3,716 in <sup>4</sup>
Deck	743.1 in <sup>2</sup>	76.25 in	56,663.3 in <sup>3</sup>	242,900 in <sup>4</sup>	2,950 in <sup>4</sup>	245,849 in <sup>4</sup>
Total	1528.9 in <sup>2</sup>		88,935.5 in <sup>3</sup>			906,123 in <sup>4</sup>

Total area of Composite Section	$A_c =$	1529 in <sup>2</sup>
Overall Depth of the Composite Section	$h_c =$	80 in
Moment of Inertia	$I_c =$	906,123 in <sup>4</sup>
Distance from centroid to extreme <u>bottom</u> fiber of beam	$y_{bc} =$	58.17 in
Distance from centroid to extreme <u>top</u> fiber of beam	$y_{tg} =$	13.83 in
Distance from centroid to extreme <u>top</u> fiber of slab	$y_{tc} =$	21.83 in
Section modulus for the extreme <u>bottom</u> fiber of beam	$S_{bc} =$	15,577.0 in <sup>3</sup>
Section modulus for the extreme <u>top</u> fiber of beam	$S_{tg} =$	65,521.8 in <sup>3</sup>
Section modulus for the extreme <u>top</u> fiber slab	$S_{tc} =$	46,501.7 in <sup>3</sup>

**Shear Forces and Bending Moments**

**DEAD LOADS**

Beam self-weight	$W_{beam} =$	0.799 k/f
8 in. deck weight	$W_{deck} =$	1.200 k/f
1/2 in. haunch weight	$W_{haunch} =$	0.022 k/f

LRFD Specifications: Art. 4.6.2.2.1

Width of Deck Constant		OK
Number of beams is not less than four $N_b =$	4	OK
Roadway part of the overhang, $d_o \leq 3.0$ ft, $d_e =$	1.5	OK
Curvature in plans is less than $4^\circ =$	0	OK
Cross-section of the bridge is consistent with one of the cross sections given by LRFD specs		OK

Barrier and wearing surface loads are equally distributed among the 4 beams

Barrier Wt	$W_t =$	0.150 k/f
Dead load of future wearing surface	$DW =$	0.263 k/f

**LIVE LOADS**

Fire truck live load front load (Point A)	$P_{live} =$	48.0 kips
Fire truck live load back load (Point B)	$P_{live} =$	22.0 kips
distance between two loads		19.2 ft
distance from nearest edge to point A	$x_a =$	59.0 ft
distance from nearest edge to point B	$x_b =$	39.8 ft

LRFD Specifications: Art. 4.6.2.2.1

Width of Deck Constant		OK
Number of beams is not less than four $N_b =$	4	OK
Beams are parallel and approximately of the same stiffness		OK
Roadway part of the overhang, $d_o \leq 3.0$ ft, $d_e =$	1.5	OK
Curvature in plans is less than $4^\circ =$	0	OK

Barrier and wearing surface loads are equally distributed among the 4 beams

Bridge Type-- "k" (LRFD Table 4.6.2.2.1-1)		
Number of design lanes = $w/12$	$=$	3 lanes

**Distribution Factor for Bending Moment:**

Beams spacing	S =	12.0 ft
Depth of concrete slab	t <sub>s</sub> =	7.5 in
Beam Span	L =	120.0 ft
Number of Beams	N <sub>b</sub> =	4
Modular ratio between beam & deck materials	n =	1.1203
Longitudinal stiffness parameter	K <sub>g</sub> =	1,812,256.42 in <sup>4</sup>

at center span:

$$DFM = 0.75 + \left(\frac{S}{9.5}\right)^{0.4} * \left(\frac{S}{L}\right)^{0.3} * \left(\frac{K_g}{12 * L * t_s^3}\right)^{0.1}$$

DFM =	0.885 lanes/beam
-------	------------------

one design lane loaded:

$$DFM = 0.75 + \left(\frac{S}{4}\right)^{0.4} * \left(\frac{S}{L}\right)^{0.3} * \left(\frac{K_g}{12 * L * t_s^3}\right)^{0.1}$$

DFM =	0.601 lanes/beam
-------	------------------

0.905 Controls

**Distribution Factor for Shear Force**

both end spans and center span:

$$DFV = 0.2 + \left(\frac{S'}{12}\right) - \left(\frac{S'}{35}\right)^2$$

DFV =	1.082 lanes/beam
-------	------------------

one design lane loaded:

$$DFV = 0.36 + \left(\frac{S}{25}\right)$$

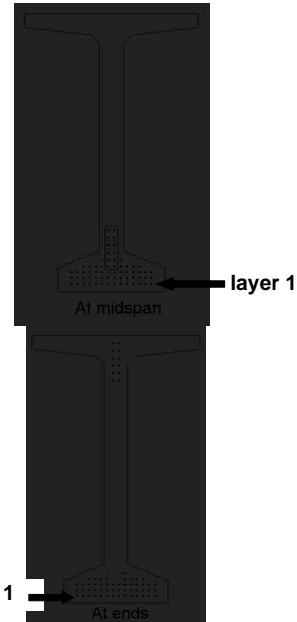
DFV =	0.840 lanes/beam
-------	------------------

1.082 Controls

from bottom	At Midspan		At Ends	
	No. of	Distance from Bottom	No. of	Distance from Bottom
layer 1	14	2	14	2
layer 2	14	3.5	14	3.5
layer 3	14	5	14	5
layer 4	10	6.5	8	6.5
layer 5	4	8	2	8
layer 6	2	10	-	-
layer 7	2	12	-	-
layer 8	2	14	-	-
layer 9	2	16	2	60
layer 10	-	-	2	62
layer 11	-	-	2	64
layer 12	-	-	2	66
layer 13	-	-	2	68
layer 14	-	-	2	70
	64		64	
<b>Harped Strand Group (included in above totals)</b>				
layer 3	2	6		
layer 4	2	8		
layer 5	2	10		
layer 6	2	12		
layer 7	2	14		
layer 8	2	16		

distance from the center of gravity of strands to the bottom fiber of the beam = 7% of the beam depth  
strand eccentricity at midspan = (y<sub>c</sub> - y<sub>bs</sub>)

y <sub>bs</sub> =	5.44 in
e <sub>c</sub> =	34.87 in



## Prestress Losses

### ELASTIC SHORTENING

assumed loss	=	6.00%
Force per strand at transfer		
layer 1	=	8.3 kips
layer 2	=	16.9 kips
layer 3	=	17.0 kips
layer 4	=	17.0 kips
layer 5	=	17.0 kips
layer 6	=	17.0 kips
layer 7	=	17.0 kips
layer 8	=	17.0 kips
layer 9	=	17.0 kips
layer 10	=	17.0 kips
layer 11	=	17.0 kips
layer 12	=	17.0 kips
layer 13	=	17.0 kips
layer 14	=	17.0 kips

Total prestressing force at release	$P_1 =$	at midspan 964.8 kips	at endspan 930.8 kips
Sum of concrete stresses at the center of gravity of prestressing tendons due to prestressing force at transfer and the self-weight of the member at sections of maximum moment	$f_{cgp} =$	2.694 ksi	2.549 ksi
Loss due to shortening		at midspan	at endspan
layer 1	$\Delta f_{pES} =$	15.5 ksi	14.7 ksi
layer 2	$\Delta f_{pES} =$	16.3 ksi	15.4 ksi
layer 3	$\Delta f_{pES} =$	15.5 ksi	14.7 ksi
layer 4	$\Delta f_{pES} =$	15.5 ksi	14.7 ksi
layer 5	$\Delta f_{pES} =$	15.5 ksi	14.7 ksi
layer 6	$\Delta f_{pES} =$	15.5 ksi	
layer 7	$\Delta f_{pES} =$	15.5 ksi	
layer 8	$\Delta f_{pES} =$	15.5 ksi	
layer 9	$\Delta f_{pES} =$	15.5 ksi	14.7 ksi
layer 10	$\Delta f_{pES} =$		14.7 ksi
layer 11	$\Delta f_{pES} =$		14.7 ksi
layer 12	$\Delta f_{pES} =$		14.7 ksi
layer 13	$\Delta f_{pES} =$		14.7 ksi
layer 14	$\Delta f_{pES} =$		14.7 ksi

### SHRINKAGE

Shrinkage = $(17 - 0.15 \times \text{Relative Humidity})$	$\Delta f_{pSR} =$	6.5 ksi	← assume relative humidity = 70%
---	--------------------	---------	----------------------------------

### CREEP OF CONCRETE

Change of stresses at center of gravity of prestressing due to permanent loads except the loads acting at time of applying prestressing force, calculated at the same section as $f_{cgp}$	$\Delta f_{cgp} =$	2.301 ksi	
loss due to creep	$\Delta f_{pCR} =$	at midspan 16.2 ksi	at endspan 14.5 ksi

### RELAXATION OF PRESTRESSING STRANDS

loss due to relaxation after transfer		at midspan	at endspan
layer 1	$\Delta f_{pR2} =$	2.8 ksi	2.9 ksi
layer 2	$\Delta f_{pR2} =$	2.7 ksi	2.8 ksi
layer 3	$\Delta f_{pR2} =$	2.8 ksi	2.9 ksi
layer 4	$\Delta f_{pR2} =$	2.8 ksi	2.9 ksi
layer 5	$\Delta f_{pR2} =$	2.8 ksi	2.9 ksi
layer 6	$\Delta f_{pR2} =$	2.8 ksi	
layer 7	$\Delta f_{pR2} =$	2.8 ksi	
layer 8	$\Delta f_{pR2} =$	2.8 ksi	
layer 9	$\Delta f_{pR2} =$	2.8 ksi	2.9 ksi
layer 10	$\Delta f_{pR2} =$		2.9 ksi
layer 11	$\Delta f_{pR2} =$		2.9 ksi
layer 12	$\Delta f_{pR2} =$		2.9 ksi
layer 13	$\Delta f_{pR2} =$		2.9 ksi
layer 14	$\Delta f_{pR2} =$		2.9 ksi

**TOTAL LOSSES AT TRANSFER**

total loss  $\Delta f_{pES} = \Delta f_{pi}$

stress in tendons after transfer  $f_{pt} = f_{pi} - \Delta f_{pi}$

		at midspan	at endspan
layer 1	$f_{pt} =$	88.9 ksi	89.8 ksi
layer 2	$f_{pt} =$	194.7 ksi	195.6 ksi
layer 3	$f_{pt} =$	197.6 ksi	198.5 ksi
layer 4	$f_{pt} =$	197.6 ksi	198.5 ksi
layer 5	$f_{pt} =$	197.6 ksi	198.5 ksi
layer 6	$f_{pt} =$	197.6 ksi	
layer 7	$f_{pt} =$	197.6 ksi	
layer 8	$f_{pt} =$	197.6 ksi	
layer 9	$f_{pt} =$	197.6 ksi	198.5 ksi
layer 10	$f_{pt} =$		198.5 ksi
layer 11	$f_{pt} =$		198.5 ksi
layer 12	$f_{pt} =$		198.5 ksi
layer 13	$f_{pt} =$		198.5 ksi
layer 14	$f_{pt} =$		198.5 ksi

force per strand =  $f_{pt} \cdot \text{strand area}$

		at midspan	at endspan
layer 1	=	7.6 kips	7.6 kips
layer 2	=	16.6 kips	16.6 kips
layer 3	=	16.8 kips	16.9 kips
layer 4	=	16.8 kips	16.9 kips
layer 5	=	16.8 kips	16.9 kips
layer 6	=	16.8 kips	
layer 7	=	16.8 kips	
layer 8	=	16.8 kips	
layer 9	=	16.8 kips	16.9 kips
layer 10	=		16.9 kips
layer 11	=		16.9 kips
layer 12	=		16.9 kips
layer 13	=		16.9 kips
layer 14	=		16.9 kips

Total prestressing force after transfer

	$P_i =$	910.0 kips	913.4 kips
--	---------	------------	------------

Initial loss =  $(\Delta f_{pi}) / (f_{pi})$

		at midspan	at endspan
layer 1	% =	14.9%	14.1%
layer 2	% =	7.7%	7.3%
layer 3	% =	7.3%	6.9%
layer 4	% =	7.3%	6.9%
layer 5	% =	7.3%	6.9%
layer 6	% =	7.3%	
layer 7	% =	7.3%	
layer 8	% =	7.3%	
layer 9	% =	7.3%	6.9%
layer 10	% =		6.9%
layer 11	% =		6.9%
layer 12	% =		6.9%
layer 13	% =		6.9%
layer 14	% =		6.9%

OK  
OK  
OK  
OK  
OK  
OK  
OK  
OK  
OK  
OK  
OK  
OK  
OK  
OK

**TOTAL LOSSES AT SERVICE LOADS**

Total Losses

		at midspan	at endspan
layer 1	$\Delta f_{pT} =$	41.0 ksi	40.2 ksi
layer 2	$\Delta f_{pT} =$	41.8 ksi	40.9 ksi
layer 3	$\Delta f_{pT} =$	41.0 ksi	40.2 ksi
layer 4	$\Delta f_{pT} =$	41.0 ksi	40.2 ksi
layer 5	$\Delta f_{pT} =$	41.0 ksi	40.2 ksi
layer 6	$\Delta f_{pT} =$	41.0 ksi	
layer 7	$\Delta f_{pT} =$	41.0 ksi	
layer 8	$\Delta f_{pT} =$	41.0 ksi	
layer 9	$\Delta f_{pT} =$	41.0 ksi	40.2 ksi
layer 10	$\Delta f_{pT} =$		40.2 ksi
layer 11	$\Delta f_{pT} =$		40.2 ksi
layer 12	$\Delta f_{pT} =$		40.2 ksi
layer 13	$\Delta f_{pT} =$		40.2 ksi
layer 14	$\Delta f_{pT} =$		40.2 ksi

Stress in tendon after all losses =  $f_{pt} - \Delta f_{pt}$

		at midspan	at endspan
layer 1	$f_{pe} =$	63.4 ksi	64.3 ksi
layer 2	$f_{pe} =$	169.2 ksi	170.1 ksi
layer 3	$f_{pe} =$	172.1 ksi	173.0 ksi
layer 4	$f_{pe} =$	172.1 ksi	173.0 ksi
layer 5	$f_{pe} =$	172.1 ksi	173.0 ksi
layer 6	$f_{pe} =$	172.1 ksi	
layer 7	$f_{pe} =$	172.1 ksi	
layer 8	$f_{pe} =$	172.1 ksi	
layer 9	$f_{pe} =$	172.1 ksi	173.0 ksi
layer 10	$f_{pe} =$		173.0 ksi
layer 11	$f_{pe} =$		173.0 ksi
layer 12	$f_{pe} =$		173.0 ksi
layer 13	$f_{pe} =$		173.0 ksi
layer 14	$f_{pe} =$		173.0 ksi

check prestressing stress limit at service limit state:  $f_{pe} \leq 0.8 \cdot f_{py}$

layer 1	=	110.9 ksi
layer 2	=	197.2 ksi
layer 3	=	203.4 ksi
layer 4	=	205.4 ksi
layer 5	=	205.4 ksi
layer 6	=	205.4 ksi
layer 7	=	205.4 ksi
layer 8	=	205.4 ksi
layer 9	=	205.4 ksi
layer 10	=	205.4 ksi
layer 11	=	205.4 ksi
layer 12	=	205.4 ksi
layer 13	=	205.4 ksi
layer 14	=	205.4 ksi

OK  
OK  
OK  
OK  
OK  
OK  
OK  
OK  
OK  
OK  
OK  
OK  
OK

force per strand =  $f_{pe} \cdot \text{strand area}$

		at midspan	at endspan
layer 1	=	5.4 kips	5.5 kips
layer 2	=	14.4 kips	14.5 kips
layer 3	=	14.6 kips	14.7 kips
layer 4	=	14.6 kips	14.7 kips
layer 5	=	14.6 kips	14.7 kips
layer 6	=	14.6 kips	
layer 7	=	14.6 kips	
layer 8	=	14.6 kips	
layer 9	=	14.6 kips	14.7 kips
layer 10	=		14.7 kips
layer 11	=		14.7 kips
layer 12	=		14.7 kips
layer 13	=		14.7 kips
layer 14	=		14.7 kips

Total prestressing force after all losses

		at midspan	at endspan
$P_{pe} =$		803.7 kips	808.2 kips

Final losses, % =  $(\Delta f_{pt}) / (f_{pi})$

layer 1	% =	39.3%	38.5%
layer 2	% =	40.0%	39.2%
layer 3	% =	39.3%	38.5%
layer 4	% =	39.3%	38.5%
layer 5	% =	39.3%	38.5%
layer 6	% =	39.3%	
layer 7	% =	39.3%	
layer 8	% =	39.3%	
layer 9	% =	39.3%	38.5%
layer 10	% =		38.5%
layer 11	% =		38.5%
layer 12	% =		38.5%
layer 13	% =		38.5%
layer 14	% =		38.5%
Average final losses, %	% =	39.3%	38.5%

## Stresses at Transfer

### STRESS LIMITS FOR CONCRETE

Compression = $0.6f'_{ci}$	$f_{ci} =$	3.300 ksi
Tension		
without bonded reinforcement = $-0.0948\sqrt{f'_{ci}} \leq -0.2$	=	-0.200 ksi
with bonded auxiliary reinforcement = $-0.22\sqrt{f'_{ci}}$	=	-0.016 ksi

### STRESSES AT TRANSFER LENGTH SECTION

Transfer Length = $60 \times (\text{strand diameter})$	=	1.9 ft
Bending moment at transfer length	$M_g =$	87.7 ft-kips
center of 12 strands to top fiber of beam at the end	=	7.00 in
center of 12 strands to bottom fiber of beam at the harp point	=	11.00 in
center of 12 strands and top fiber of beam at transfer length	=	9.84 in
center of gravity of 32 strands and bottom fiber of beam	=	3.98 in
center of gravity of all strands and the bottom fiber of beam at transfer length	=	15.24 in
center of gravity of all strands and the bottom fiber of beam at the end	=	15.30 in
Eccentricity of the strand group at transfer length:	$e_t =$	25.07 in
Eccentricity at end of beam:	$e =$	25.01 in

Calcs for eccentricity (see 9.6.7.2)

$$f_t = \frac{P_i}{A} - \frac{P_i e}{S_t} + \frac{M_g}{S_t}$$

$$f_b = \frac{P_i}{A} + \frac{P_i e}{S_b} - \frac{M_g}{S_b}$$

		at midspan	at endspan
Top stress at top fiber of beam	$f_t =$	-0.225 ksi	-0.226 ksi
Bottom stress at bottom fiber of the beam	$f_b =$	2.809 ksi	2.809 ksi

OK

OK

### STRESSES AT HARP POINT

Bending moment due to beam weight at 0.3L	$M_g =$	1188.0 ft-kips
Top stress at top fiber of beam	$f_t =$	0.053 ksi
Bottom stress at bottom fiber of the beam	$f_b =$	2.558 ksi

OK

OK

### STRESSES AT MIDSPAN

Bending moment due to beam weight at 0.5L	$M_g =$	1414.3 ft-kips
Top stress at top fiber of beam	$f_t =$	0.177 ksi
Bottom stress at bottom fiber of the beam	$f_b =$	2.376 ksi

OK

OK

### HOLD-DOWN FORCES

assume stress in strand before losses =  $0.8f_u$

layer 1	=	111.4 ksi
layer 2	=	225.1 ksi
layer 3	=	227.4 ksi
layer 4	=	227.4 ksi
layer 5	=	227.4 ksi
layer 6	=	227.4 ksi
layer 7	=	227.4 ksi
layer 8	=	227.4 ksi
layer 9	=	227.4 ksi
layer 10	=	227.4 ksi
layer 11	=	227.4 ksi
layer 12	=	227.4 ksi
layer 13	=	227.4 ksi
layer 14	=	227.4 ksi

prestress force per strand before any losses:

layer 1	=	9.5 kips
layer 2	=	19.1 kips
layer 3	=	19.3 kips
layer 4	=	19.3 kips
layer 5	=	19.3 kips
layer 6	=	19.3 kips
layer 7	=	19.3 kips
layer 8	=	19.3 kips
layer 9	=	19.3 kips
layer 10	=	19.3 kips
layer 11	=	19.3 kips
layer 12	=	19.3 kips
layer 13	=	19.3 kips
layer 14	=	19.3 kips
Harp Angle	$\psi =$	7.2 °



Hold-down force/strand

layer 1	=	1.2 kips/strand
layer 2	=	2.5 kips/strand
layer 3	=	2.5 kips/strand
layer 4	=	2.5 kips/strand
layer 5	=	2.5 kips/strand
layer 6	=	2.5 kips/strand
layer 7	=	2.5 kips/strand
layer 8	=	2.5 kips/strand
layer 9	=	2.5 kips/strand
layer 10	=	2.5 kips/strand
layer 11	=	2.5 kips/strand
layer 12	=	2.5 kips/strand
layer 13	=	2.5 kips/strand
layer 14	=	2.5 kips/strand
Total hold-down force	=	30.45 kips

**Stresses at Service Loads**

**STRESS LIMITS FOR CONCRETE**

**Compression:**

Due to permanent loads for load combination Service I

for the precast beam	=	2.259 ksi
for deck	=	1.800 ksi

Due to permanent and transient loads for load combination Service I

for the precast beam	=	3.012 ksi
for deck	=	2.400 ksi

**Tension:**

Load Combination Service III

for the precast beam	=	-0.013 ksi
----------------------	---	------------

**STRESSES AT MIDSPAN**

Compression stresses at top fiber of beam	at midspan	at endspan	
$f_t = \frac{P_{ps}}{A} - \frac{P_{ps}e}{S_x} + \frac{(M_{ps} + M_{s1})}{S_x} + \frac{(M_{ps} + M_{s2})}{S_{xy}}$			
Due to permanent loads	$f_{t0} =$	2.005 ksi	2.000 ksi
			OK
$f_{tr} = \frac{P_{ps}}{A} - \frac{P_{ps}e}{S_x} + \frac{(M_{ps} + M_{s1})}{S_x} + \frac{(M_{ps} - M_{s2})}{S_{xy}} + \frac{(M_{s2,1})}{S_{xy}}$			
Due to permanent loads and transient loads	$f_{t0} =$	2.392 ksi	2.387 ksi
			OK
Compression stresses at top fiber of deck	at midspan	at endspan	
$f_{tr} = \frac{(M_{ps} + M_{s1})}{S_{tr}}$			
Due to permanent loads	$f_{t0} =$	0.052 ksi	0.052 ksi
			OK
$f_{tr} = \frac{(M_{ps} + M_{s1} + M_{s2,1})}{S_{tr}}$			
Due to permanent loads and transient loads	$f_{t0} =$	0.598 ksi	0.598 ksi
			OK
Tension stresses at top fiber of deck	at midspan	at endspan	
$f_{tr} = \frac{P_{ps}}{A} + \frac{P_{ps}e}{S_x} - \frac{(M_{ps} + M_{s1})}{S_x} - \frac{(M_{ps} + M_{s1} + 0.5 * M_{s2,1})}{S_{tr}}$			
Load Combination Service III	$f_{t0} =$	-1.362 ksi	-1.345 ksi
			OK

### Strength Limit State

POSITIVE MOMENT SECTION		
$M_u = 1.25DC+1.5DW+1.75(LL+IM)$	$M_u =$	8381.5 ft-kips
effective length factor for compression members		
layer 1	k =	0.09
layer 2	k =	0.33
layer 3	k =	0.29
layer 4	k =	0.27
layer 5	k =	0.27
layer 6	k =	0.27
layer 7	k =	0.27
layer 8	k =	0.27
layer 9	k =	0.27
layer 10	k =	0.27
layer 11	k =	0.27
layer 12	k =	0.27
layer 13	k =	0.27
layer 14	k =	0.27
	c =	4.1 ft-kips

average stress in prestressing steel

layer 1	$f_{ps} =$	138.6 ksi
layer 2	$f_{ps} =$	280.0 ksi
layer 3	$f_{ps} =$	282.8 ksi
layer 4	$f_{ps} =$	282.8 ksi
layer 5	$f_{ps} =$	282.8 ksi
layer 6	$f_{ps} =$	282.8 ksi
layer 7	$f_{ps} =$	282.8 ksi
layer 8	$f_{ps} =$	282.8 ksi
layer 9	$f_{ps} =$	282.8 ksi
layer 10	$f_{ps} =$	282.8 ksi
layer 11	$f_{ps} =$	282.8 ksi
layer 12	$f_{ps} =$	282.8 ksi
layer 13	$f_{ps} =$	282.8 ksi
layer 14	$f_{ps} =$	282.8 ksi

nominal flexure resistance

	a =	3.49 in	
$M_r = \Phi M_n, \Phi = 1.00$	$\Phi M_n =$	8224.2 ft-kips	NOT OK
M=DC+W+LL+IM	M =	5833.6 ft-kips	OK

NEGATIVE MOMENT SECTION			
$M_u = 1.25DC+1.5DW+1.75(LL+IM)$	$M_u =$	4837.2 ft-kips	
	a =	7.99 in	
	$\Phi M_n =$	4803.8 ft-kips	NOT OK
M=DC+W+LL+IM	M =	2869.7 ft-kips	OK

### Shear Design

CRITICAL SECTION AT 0.59		
$V_u = 1.25DC+1.5DW+1.75(LL+IM)$	$V_u =$	405.0 kips
$M_u = 1.25DC+1.5DW+1.75(LL+IM)$	$M_u =$	-2684.4 ft-kips
or		
$V_u = 1.25DC+1.5DW+1.75(LL+IM)$	$V_u =$	364.8 kips
$M_u = 1.25DC+1.5DW+1.75(LL+IM)$	$M_u =$	-2877.0 ft-kips
max shear	$V_u =$	405.0 kips
max moment	$M_u =$	2877.0 ft-kips
Shear depth	$d_v =$	73.19 in
Applied factored normal force at the section	$N_u =$	0
Angle of diagonal compressive stresses	$\theta =$	36.00 °

**STRAIN IN FLEXURAL TENSION REINFORCEMENT**

$$\epsilon_s = \frac{\frac{M}{A_v} + 0.5M_s + 0.5M_u \cos \theta + A_{ps} f_{ps}}{E_s A_s + E_p A_{ps}} \leq 0.002$$

		<b>at midspan</b>	<b>at endspan</b>
resultant compressive stress at centroid	$f_{pc} =$	0.623 ksi	0.624 ksi

effective stress in prestressing strand after all losses

layer 1	$f_{po} =$	67.2 ksi	68.0 ksi
layer 2	$f_{po} =$	173.2 ksi	174.1 ksi
layer 3	$f_{po} =$	175.9 ksi	176.7 ksi
layer 4	$f_{po} =$	175.9 ksi	176.7 ksi
layer 5	$f_{po} =$	175.9 ksi	
layer 6	$f_{po} =$	175.9 ksi	
layer 7	$f_{po} =$	175.9 ksi	
layer 8	$f_{po} =$	175.9 ksi	
layer 9	$f_{po} =$		176.7 ksi
layer 10	$f_{po} =$		176.7 ksi
layer 11	$f_{po} =$		176.7 ksi
layer 12	$f_{po} =$		176.7 ksi
layer 13	$f_{po} =$		176.7 ksi
layer 14	$f_{po} =$		176.7 ksi

strain in flexural tension

		<b>at midspan</b>	<b>at endspan</b>
layer 1	$\epsilon_x =$	0.002000	0.002000
layer 2	$\epsilon_x =$	0.002000	0.002000
layer 3	$\epsilon_x =$	0.002000	0.002000
layer 4	$\epsilon_x =$	0.002000	0.002000
layer 5	$\epsilon_x =$	0.002000	
layer 6	$\epsilon_x =$	0.002000	
layer 7	$\epsilon_x =$	0.002000	
layer 8	$\epsilon_x =$	0.002000	
layer 9	$\epsilon_x =$		0.002000
layer 10	$\epsilon_x =$		0.002000
layer 11	$\epsilon_x =$		0.002000
layer 12	$\epsilon_x =$		0.002000
layer 13	$\epsilon_x =$		0.002000
layer 14	$\epsilon_x =$		0.002000

**Deflection and Camber**

		<b>at midspan</b>	<b>at endspan</b>
Deflection due to Prestressing Force at Transfer	$\Delta_p =$	3.35 in	3.29 in
Deflection due to Beam Self-Weight at Transfer	$\Delta_g =$	-1.95 in	
Deflection due to Beam Self-Weight at Erection	$\Delta_y =$	-1.97 in	
Deflection due to Haunch and Deck	$\Delta_s =$	-3.01 in	
Deflection due to total self weight	$\Delta_{sw} =$	-1.63 in	
Total Deflection at transfer	$\Delta =$	1.40 in	1.35 in
Total Deflection at erection	$\Delta =$	2.39 in	2.28 in
Live load deflection limit = span/800	$=$	-1.80 in	
Deflection due to live load and impact	$\Delta_L =$	-1.13 in	
Deflection due to fire truck	$\Delta_L =$	-2.2365 in	
Total Deflection after fire with fire truck	$\Delta =$	-0.5193 in	

OK

NOT OK

**Parametric Design: Puyallup River Case Study**  
**Beam Design: 3/8" Strand**  
**Fire Exposure Status: 2 Hours**

(PCI Bridge Design Manual Section 9.6)

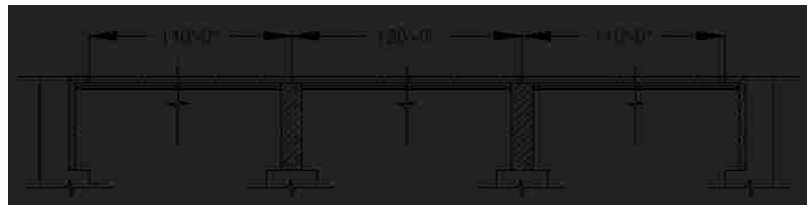


**Material Properties**

CAST-IN-PLACE SLAB			
Actual Thickness	$t_{as} =$		8.0 in
Wearing Surface	$=$		0.5 in
Structural thickness = Actual - Wearing Surface	$t_s =$		7.5 in
Compressive Strength	$f'_c =$		4 ksi
Unit Weight	$w_c =$		150.0 pcf
Stress factor of compression block	$\beta_1 =$		0.85

BEAMS: AASHTO-PCI, BT-72 BULB-TEE			
Strength at release	$f'_{ci} =$		5.5 ksi
Strength at 28 days	$f'_c =$		4.40 ksi
Unit Weight	$w_c =$		150.0 pcf
Overall Beam Length:			
@ end spans	$L =$		110 ft
@ center span	$L =$		119 ft
Design Spans:			
Non-composite beam @ end spans	$L =$		109 ft
Non-composite beam @ center span	$L =$		118 ft
Composite beam @ end spans	$L =$		110 ft
Composite beam @ center span	$L =$		120 ft
Beam Spacing	$S =$		12 ft



**PRESTRESSING STRANDS**

Diameter of single strand	d =	0.375 in
Area of single strand	A =	0.085 in <sup>2</sup>

Temperature of Layer

layer 1 (bottom)	T =	1580.00 °F
layer 2	T =	780.00 °F
layer 3	T =	255.00 °F
layer 4	T =	68.00 °F
layer 5	T =	68.00 °F
layer 6	T =	68.00 °F
layer 7	T =	68.00 °F
layer 8	T =	68.00 °F
layer 9	T =	68.00 °F
layer 10	T =	68.00 °F
layer 11	T =	68.00 °F
layer 12	T =	68.00 °F
layer 13	T =	68.00 °F
layer 14	T =	68.00 °F

Ultimate Strength

initial = 284 ksi

layer 1 (bottom)	f <sub>pu</sub> =	94 ksi
layer 2	f <sub>pu</sub> =	256 ksi
layer 3	f <sub>pu</sub> =	284 ksi
layer 4	f <sub>pu</sub> =	284 ksi
layer 5	f <sub>pu</sub> =	284 ksi
layer 6	f <sub>pu</sub> =	284 ksi
layer 7	f <sub>pu</sub> =	284 ksi
layer 8	f <sub>pu</sub> =	284 ksi
layer 9	f <sub>pu</sub> =	284 ksi
layer 10	f <sub>pu</sub> =	284 ksi
layer 11	f <sub>pu</sub> =	284 ksi
layer 12	f <sub>pu</sub> =	284 ksi
layer 13	f <sub>pu</sub> =	284 ksi
layer 14	f <sub>pu</sub> =	284 ksi

Yield Strength

initial = 257 ksi

layer 1 (bottom)	f <sub>py</sub> =	98 ksi
layer 2	f <sub>py</sub> =	252 ksi
layer 3	f <sub>py</sub> =	257 ksi
layer 4	f <sub>py</sub> =	257 ksi
layer 5	f <sub>py</sub> =	257 ksi
layer 6	f <sub>py</sub> =	257 ksi
layer 7	f <sub>py</sub> =	257 ksi
layer 8	f <sub>py</sub> =	257 ksi
layer 9	f <sub>py</sub> =	257 ksi
layer 10	f <sub>py</sub> =	257 ksi
layer 11	f <sub>py</sub> =	257 ksi
layer 12	f <sub>py</sub> =	257 ksi
layer 13	f <sub>py</sub> =	257 ksi
layer 14	f <sub>py</sub> =	257 ksi

**Stress Limits:**

before transfer ≤ 0.75f<sub>pu</sub> (initial = 202.5)

layer 1 (bottom)	f <sub>pl</sub> =	70.3 ksi
layer 2	f <sub>pl</sub> =	191.8 ksi
layer 3	f <sub>pl</sub> =	213.2 ksi
layer 4	f <sub>pl</sub> =	213.2 ksi
layer 5	f <sub>pl</sub> =	213.2 ksi
layer 6	f <sub>pl</sub> =	213.2 ksi
layer 7	f <sub>pl</sub> =	213.2 ksi
layer 8	f <sub>pl</sub> =	213.2 ksi
layer 9	f <sub>pl</sub> =	213.2 ksi
layer 10	f <sub>pl</sub> =	213.2 ksi
layer 11	f <sub>pl</sub> =	213.2 ksi
layer 12	f <sub>pl</sub> =	213.2 ksi
layer 13	f <sub>pl</sub> =	213.2 ksi
layer 14	f <sub>pl</sub> =	213.2 ksi

at service limit state (after all losses)  $\leq 0.80f_{py}$  (initial = 194.4)

layer 1 (bottom)	$f_{pe} =$	78.1 ksi
layer 2	$f_{pe} =$	201.3 ksi
layer 3	$f_{pe} =$	205.4 ksi
layer 4	$f_{pe} =$	205.4 ksi
layer 5	$f_{pe} =$	205.4 ksi
layer 6	$f_{pe} =$	205.4 ksi
layer 7	$f_{pe} =$	205.4 ksi
layer 8	$f_{pe} =$	205.4 ksi
layer 9	$f_{pe} =$	205.4 ksi
layer 10	$f_{pe} =$	205.4 ksi
layer 11	$f_{pe} =$	205.4 ksi
layer 12	$f_{pe} =$	205.4 ksi
layer 13	$f_{pe} =$	205.4 ksi
layer 14	$f_{pe} =$	205.4 ksi

Modulus of Elasticity

initial = 25898 ksi

layer 1 (bottom)	E =	27192.9 ksi
layer 2	E =	27710.9 ksi
layer 3	E =	27710.9 ksi
layer 4	E =	27710.9 ksi
layer 5	E =	27710.9 ksi
layer 6	E =	27451.9 ksi
layer 7	E =	26933.9 ksi
layer 8	E =	27192.9 ksi
layer 9	E =	27192.9 ksi
layer 10	E =	25898.0 ksi
layer 11	E =	25898.0 ksi
layer 12	E =	25898.0 ksi
layer 13	E =	25898.0 ksi
layer 14	E =	25898.0 ksi

#### REINFORCING BARS

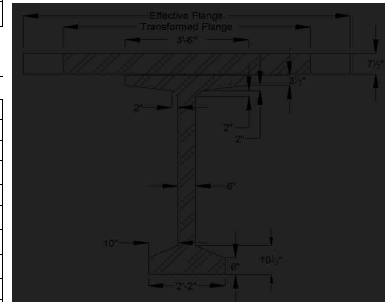
Yield Strength	$f_y =$	57.6 ksi
Modulus of Elasticity	E =	29000.0 ksi

Area of steel at endspan (effective flange)	$A_{se} =$	15.4 in <sup>2</sup>
Area of steel at midspan (effective flange)	$A_{sm} =$	0.0 in <sup>2</sup>
Area of temperature and shrinkage steel (12" width)	$A_s =$	0.0 in <sup>2</sup>

#### Cross-sectional Properties

##### NON-COMPOSITE BEAM

Area of cross-section of beam	A =	767.0 in <sup>2</sup>
Overall depth of beam	H =	72.0 in
Moment of Inertia	I =	386,902 in <sup>4</sup>
Distance from centroid to extreme <b>bottom</b> fiber	$y_b =$	43.7 in
Distance from centroid to extreme <b>top</b> fiber	$y_t =$	28.3 in
Section modulus for the extreme <b>bottom</b> fiber	$S_b =$	14915.0 in <sup>3</sup>
Section modulus for the extreme <b>top</b> fiber	$S_t =$	15421.0 in <sup>3</sup>
Weight	$W_t =$	799.0 plf
Modulus of Elasticity = $33000 \cdot (W_c \cdot 1.5) \cdot (\sqrt{f'_c})$		
cast-in-place concrete deck	$E_{cs} =$	3834 ksi
precast beam at release	$E_{ci} =$	4496 ksi
precast beam at service loads	$E_c =$	4021 ksi



**COMPOSITE BEAM AT MIDSPAN**

Effective Flange Width	$b_f =$	111.0 in	*min of three criteria
Modular Ratio = $E_{cs}/E_c$	$n =$	0.9535	
Transformed flange width	$=$	105.8 in	
Transformed flange area	$=$	793.8 in <sup>2</sup>	
Transformed haunch width	$=$	40.0 in	
Transformed haunch area	$=$	20.0 in <sup>2</sup>	

	Transformed Area	$y_b$	$Ay_b$	$A(y_{bc}-y_b)^2$	I	$I + A(y_{bc}-y_b)^2$
Beam	767.0 in <sup>2</sup>	43.67 in	33,494.9 in <sup>3</sup>	214,457 in <sup>4</sup>	386,902 in <sup>4</sup>	601,359 in <sup>4</sup>
Haunch	20.0 in <sup>2</sup>	72.25 in	1,446.6 in <sup>3</sup>	2,816 in <sup>4</sup>	0.33 in <sup>4</sup>	2,816 in <sup>4</sup>
Deck	793.8 in <sup>2</sup>	76.25 in	60,524.0 in <sup>3</sup>	199,626 in <sup>4</sup>	2,950 in <sup>4</sup>	202,576 in <sup>4</sup>
Total	1580.8 in <sup>2</sup>		95,465.5 in <sup>3</sup>			806,751 in <sup>4</sup>

Total area of Composite Section	$A_c =$	1581 in <sup>2</sup>
Overall Depth of the Composite Section	$h_c =$	80 in
Moment of Inertia	$I_c =$	806,751 in <sup>4</sup>
Distance from centroid to extreme <u>bottom</u> fiber of beam	$y_{bc} =$	60.39 in
Distance from centroid to extreme <u>top</u> fiber of beam	$y_{tb} =$	11.61 in
Distance from centroid to extreme <u>top</u> fiber of slab	$y_{tc} =$	19.61 in
Section modulus for the extreme <u>bottom</u> fiber of beam	$S_{bc} =$	13,358.7 in <sup>3</sup>
Section modulus for the extreme <u>top</u> fiber of beam	$S_{tb} =$	69,496.0 in <sup>3</sup>
Section modulus for the extreme <u>top</u> fiber slab	$S_{tc} =$	43,150.8 in <sup>3</sup>

**Shear Forces and Bending Moments**

**DEAD LOADS**

Beam self-weight	$w_{beam} =$	0.799 k/f
8 in. deck weight	$w_{deck} =$	1.200 k/f
1/2 in. haunch weight	$w_{haunch} =$	0.022 k/f

LRFD Specifications: Art. 4.6.2.2.1

Width of Deck Constant		OK
Number of beams is not less than four $N_b =$	4	OK
Roadway part of the overhang, $d_e \leq 3.0$ ft, $d_e =$	1.5	OK
Curvature in plans is less than $4^\circ =$	0	OK
Cross-section of the bridge is consistent with one of the cross sections given by LRFD specs		OK

Barrier and wearing surface loads are equally distributed among the 4 beams

Barrier Wt	$Wt =$	0.150 k/f
Dead load of future wearing surface	$DW =$	0.263 k/f

**LIVE LOADS**

Fire truck live load front load (Point A)	$P_{live} =$	48.0 kips
Fire truck live load back load (Point B)	$P_{live} =$	22.0 kips
distance between two loads		19.2 ft
distance from nearest edge to point A	$x_a =$	59.0 ft
distance from nearest edge to point B	$x_b =$	39.8 ft

LRFD Specifications: Art. 4.6.2.2.1

Width of Deck Constant		OK
Number of beams is not less than four $N_b =$	4	OK
Beams are parallel and approximately of the same stiffness		OK
Roadway part of the overhang, $d_e \leq 3.0$ ft, $d_e =$	1.5	OK
Curvature in plans is less than $4^\circ =$	0	OK

Barrier and wearing surface loads are equally distributed among the 4 beams

Bridge Type-- "k" (LRFD Table 4.6.2.2.1-1)

Number of design lanes = $w/12$	$=$	3 lanes
---------------------------------	-----	---------

**Distribution Factor for Bending Moment:**

Beams spacing	S =	12.0 ft
Depth of concrete slab	t <sub>s</sub> =	7.5 in
Beam Span	L =	120.0 ft
Number of Beams	N <sub>b</sub> =	4
Modular ratio between beam & deck materials	n =	1.0488
Longitudinal stiffness parameter	K <sub>g</sub> =	1,670,458.43 in <sup>4</sup>

at center span:

$$DFM = 0.75 + \left(\frac{S}{9.5}\right)^{0.6} * \left(\frac{S}{L}\right)^{1.2} * \left(\frac{K_g}{13 * L * t_s^3}\right)^{0.1}$$

DFM =	0.878 lanes/beam
-------	------------------

one design lane loaded:

$$DFM = 0.75 + \left(\frac{S}{14}\right)^{1.4} * \left(\frac{S}{L}\right)^{0.3} * \left(\frac{K_g}{13 * L * t_s^3}\right)^{0.1}$$

DFM =	0.596 lanes/beam
-------	------------------

0.905 Controls

**Distribution Factor for Shear Force**

both end spans and center span:

$$DFV = 0.2 + \left(\frac{S}{12}\right) - \left(\frac{S}{35}\right)^2$$

DFV =	1.082 lanes/beam
-------	------------------

one design lane loaded:

$$DFV = 0.36 + \left(\frac{S}{25}\right)$$

DFV =	0.840 lanes/beam
-------	------------------

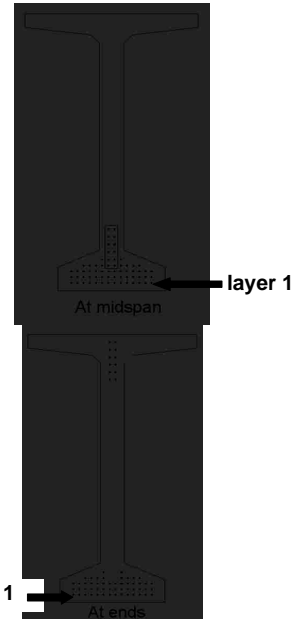
1.082 Controls

from bottom	At Midspan		At Ends	
	No. of	Distance from Bottom	No. of	Distance from Bottom
layer 1	14	2	14	2
layer 2	14	3.5	14	3.5
layer 3	14	5	14	5
layer 4	10	6.5	8	6.5
layer 5	4	8	2	8
layer 6	2	10	-	-
layer 7	2	12	-	-
layer 8	2	14	-	-
layer 9	2	16	2	60
layer 10	-	-	2	62
layer 11	-	-	2	64
layer 12	-	-	2	66
layer 13	-	-	2	68
layer 14	-	-	2	70
	64		64	
<b>Harped Strand Group (included in above totals)</b>				
layer 3	2	6		
layer 4	2	8		
layer 5	2	10		
layer 6	2	12		
layer 7	2	14		
layer 8	2	16		

distance from the center of gravity of strands to the bottom fiber of the beam = 7% of the beam depth  
strand eccentricity at midspan = (y<sub>c</sub> - y<sub>bs</sub>)

y <sub>bs</sub> =	5.44 in
e <sub>c</sub> =	38.23 in

layer 1





## Prestress Losses

### ELASTIC SHORTENING

assumed loss	=	6.00%
Force per strand at transfer		
layer 1	=	5.6 kips
layer 2	=	15.3 kips
layer 3	=	17.0 kips
layer 4	=	17.0 kips
layer 5	=	17.0 kips
layer 6	=	17.0 kips
layer 7	=	17.0 kips
layer 8	=	17.0 kips
layer 9	=	17.0 kips
layer 10	=	17.0 kips
layer 11	=	17.0 kips
layer 12	=	17.0 kips
layer 13	=	17.0 kips
layer 14	=	17.0 kips

Total prestressing force at release	$P_i =$	at midspan 904.6 kips	at endspan 870.6 kips
Sum of concrete stresses at the center of gravity of prestressing tendons due to prestressing force at transfer and the self-weight of the member at sections of maximum moment	$f_{cgp} =$	2.948 ksi	2.775 ksi
Loss due to shortening		at midspan	at endspan
layer 1	$\Delta f_{pES} =$	17.8 ksi	16.8 ksi
layer 2	$\Delta f_{pES} =$	18.2 ksi	17.1 ksi
layer 3	$\Delta f_{pES} =$	18.2 ksi	17.1 ksi
layer 4	$\Delta f_{pES} =$	18.2 ksi	17.1 ksi
layer 5	$\Delta f_{pES} =$	18.2 ksi	17.1 ksi
layer 6	$\Delta f_{pES} =$	18.0 ksi	
layer 7	$\Delta f_{pES} =$	17.7 ksi	
layer 8	$\Delta f_{pES} =$	17.8 ksi	
layer 9	$\Delta f_{pES} =$	17.8 ksi	16.8 ksi
layer 10	$\Delta f_{pES} =$		16.0 ksi
layer 11	$\Delta f_{pES} =$		16.0 ksi
layer 12	$\Delta f_{pES} =$		16.0 ksi
layer 13	$\Delta f_{pES} =$		16.0 ksi
layer 14	$\Delta f_{pES} =$		16.0 ksi

### SHRINKAGE

Shrinkage = (17-0.15*Relative Humidity)	$\Delta f_{pSR} =$	6.5 ksi	← assume relative humidity = 70%
---	--------------------	---------	----------------------------------

### CREEP OF CONCRETE

Change of stresses at center of gravity of prestressing due to permanent loads except the loads acting at time of applying prestressing force, calculated at the same section as $f_{cgp}$	$\Delta f_{cgp} =$	2.686 ksi	
loss due to creep	$\Delta f_{pCR} =$	at midspan 16.6 ksi	at endspan 14.5 ksi

### RELAXATION OF PRESTRESSING STRANDS

loss due to relaxation after transfer		at midspan	at endspan
layer 1	$\Delta f_{pR2} =$	2.5 ksi	2.6 ksi
layer 2	$\Delta f_{pR2} =$	2.4 ksi	2.6 ksi
layer 3	$\Delta f_{pR2} =$	2.4 ksi	2.6 ksi
layer 4	$\Delta f_{pR2} =$	2.4 ksi	2.6 ksi
layer 5	$\Delta f_{pR2} =$	2.4 ksi	2.6 ksi
layer 6	$\Delta f_{pR2} =$	2.5 ksi	
layer 7	$\Delta f_{pR2} =$	2.5 ksi	
layer 8	$\Delta f_{pR2} =$	2.5 ksi	
layer 9	$\Delta f_{pR2} =$	2.5 ksi	2.6 ksi
layer 10	$\Delta f_{pR2} =$		2.7 ksi
layer 11	$\Delta f_{pR2} =$		2.7 ksi
layer 12	$\Delta f_{pR2} =$		2.7 ksi
layer 13	$\Delta f_{pR2} =$		2.7 ksi
layer 14	$\Delta f_{pR2} =$		2.7 ksi

**TOTAL LOSSES AT TRANSFER**

total loss  $\Delta f_{pES} = \Delta f_{pi}$

stress in tendons after transfer  $f_{pt} = f_{pi} - \Delta f_{pi}$

		at midspan	at endspan
layer 1	$f_{pt} =$	52.5 ksi	53.6 ksi
layer 2	$f_{pt} =$	173.7 ksi	174.7 ksi
layer 3	$f_{pt} =$	195.0 ksi	196.0 ksi
layer 4	$f_{pt} =$	195.0 ksi	196.0 ksi
layer 5	$f_{pt} =$	195.0 ksi	196.0 ksi
layer 6	$f_{pt} =$	195.2 ksi	
layer 7	$f_{pt} =$	195.5 ksi	
layer 8	$f_{pt} =$	195.3 ksi	
layer 9	$f_{pt} =$	195.3 ksi	196.4 ksi
layer 10	$f_{pt} =$		197.2 ksi
layer 11	$f_{pt} =$		197.2 ksi
layer 12	$f_{pt} =$		197.2 ksi
layer 13	$f_{pt} =$		197.2 ksi
layer 14	$f_{pt} =$		197.2 ksi

force per strand =  $f_{pt} \cdot \text{strand area}$

		at midspan	at endspan
layer 1	=	4.5 kips	4.6 kips
layer 2	=	14.8 kips	14.9 kips
layer 3	=	16.6 kips	16.7 kips
layer 4	=	16.6 kips	16.7 kips
layer 5	=	16.6 kips	16.7 kips
layer 6	=	16.6 kips	
layer 7	=	16.6 kips	
layer 8	=	16.6 kips	
layer 9	=	16.6 kips	16.7 kips
layer 10	=		16.8 kips
layer 11	=		16.8 kips
layer 12	=		16.8 kips
layer 13	=		16.8 kips
layer 14	=		16.8 kips
Total prestressing force after transfer	$P_i =$	834.6 kips	841.8 kips

Initial loss =  $(\Delta f_{pi}) / (f_{pi})$

		at midspan	at endspan
layer 1	% =	25.3%	23.9%
layer 2	% =	9.5%	8.9%
layer 3	% =	8.5%	8.0%
layer 4	% =	8.5%	8.0%
layer 5	% =	8.5%	8.0%
layer 6	% =	8.4%	
layer 7	% =	8.3%	
layer 8	% =	8.4%	
layer 9	% =	8.4%	7.9%
layer 10	% =		7.5%
layer 11	% =		7.5%
layer 12	% =		7.5%
layer 13	% =		7.5%
layer 14	% =		7.5%

OK  
OK  
OK  
OK  
OK  
OK  
OK  
OK  
OK  
OK  
OK  
OK  
OK  
OK

**TOTAL LOSSES AT SERVICE LOADS**

Total Losses		at midspan	at endspan
layer 1	$\Delta f_{pT} =$	43.4 ksi	42.3 ksi
layer 2	$\Delta f_{pT} =$	43.7 ksi	42.7 ksi
layer 3	$\Delta f_{pT} =$	43.7 ksi	42.7 ksi
layer 4	$\Delta f_{pT} =$	43.7 ksi	42.7 ksi
layer 5	$\Delta f_{pT} =$	43.7 ksi	42.7 ksi
layer 6	$\Delta f_{pT} =$	43.5 ksi	
layer 7	$\Delta f_{pT} =$	43.2 ksi	
layer 8	$\Delta f_{pT} =$	43.4 ksi	
layer 9	$\Delta f_{pT} =$	43.4 ksi	42.3 ksi
layer 10	$\Delta f_{pT} =$		41.5 ksi
layer 11	$\Delta f_{pT} =$		41.5 ksi
layer 12	$\Delta f_{pT} =$		41.5 ksi
layer 13	$\Delta f_{pT} =$		41.5 ksi
layer 14	$\Delta f_{pT} =$		41.5 ksi

Stress in tendon after all losses =  $f_{pt} - \Delta f_{pt}$

		at midspan	at endspan
layer 1	$f_{pe} =$	27.0 ksi	28.0 ksi
layer 2	$f_{pe} =$	148.1 ksi	149.2 ksi
layer 3	$f_{pe} =$	169.4 ksi	170.5 ksi
layer 4	$f_{pe} =$	169.4 ksi	170.5 ksi
layer 5	$f_{pe} =$	169.4 ksi	170.5 ksi
layer 6	$f_{pe} =$	169.6 ksi	
layer 7	$f_{pe} =$	169.9 ksi	
layer 8	$f_{pe} =$	169.8 ksi	
layer 9	$f_{pe} =$	169.8 ksi	170.8 ksi
layer 10	$f_{pe} =$		171.6 ksi
layer 11	$f_{pe} =$		171.6 ksi
layer 12	$f_{pe} =$		171.6 ksi
layer 13	$f_{pe} =$		171.6 ksi
layer 14	$f_{pe} =$		171.6 ksi

check prestressing stress limit at service limit state:  $f_{pe} \leq 0.8 \cdot f_{py}$

layer 1	=	78.1 ksi
layer 2	=	201.3 ksi
layer 3	=	205.4 ksi
layer 4	=	205.4 ksi
layer 5	=	205.4 ksi
layer 6	=	205.4 ksi
layer 7	=	205.4 ksi
layer 8	=	205.4 ksi
layer 9	=	205.4 ksi
layer 10	=	205.4 ksi
layer 11	=	205.4 ksi
layer 12	=	205.4 ksi
layer 13	=	205.4 ksi
layer 14	=	205.4 ksi

OK  
OK  
OK  
OK  
OK  
OK  
OK  
OK  
OK  
OK  
OK  
OK  
OK  
OK

force per strand =  $f_{pe} \cdot \text{strand area}$

		at midspan	at endspan
layer 1	=	2.3 kips	2.4 kips
layer 2	=	12.6 kips	12.7 kips
layer 3	=	14.4 kips	14.5 kips
layer 4	=	14.4 kips	14.5 kips
layer 5	=	14.4 kips	14.5 kips
layer 6	=	14.4 kips	
layer 7	=	14.4 kips	
layer 8	=	14.4 kips	
layer 9	=	14.4 kips	14.5 kips
layer 10	=		14.6 kips
layer 11	=		14.6 kips
layer 12	=		14.6 kips
layer 13	=		14.6 kips
layer 14	=		14.6 kips

Total prestressing force after all losses

	at midspan	at endspan
$P_{pe} =$	727.1 kips	733.6 kips

Final losses, % =  $(\Delta f_{pt}) / (f_{pi})$

layer 1	% =	61.7%	60.2%
layer 2	% =	62.1%	60.6%
layer 3	% =	62.1%	60.6%
layer 4	% =	62.1%	60.6%
layer 5	% =	62.1%	60.6%
layer 6	% =	61.9%	
layer 7	% =	61.4%	
layer 8	% =	61.7%	
layer 9	% =	61.7%	60.2%
layer 10	% =		59.0%
layer 11	% =		59.0%
layer 12	% =		59.0%
layer 13	% =		59.0%
layer 14	% =		59.0%
Average final losses, %	% =	61.9%	59.8%

### Stresses at Transfer

#### STRESS LIMITS FOR CONCRETE

Compression = $0.6f'_{ci}$	$f_{ci} =$	3.300 ksi
Tension		
without bonded reinforcement = $-0.0948\sqrt{f'_{ci}} \leq -0.2$	=	-0.200 ksi
with bonded auxiliary reinforcement = $-0.22\sqrt{f'_{ci}}$	=	-0.016 ksi

#### STRESSES AT TRANSFER LENGTH SECTION

Transfer Length = $60 \times$ (strand diameter)	=	1.9 ft	} Calcs for eccentricity (see 9.6.7.2)
Bending moment at transfer length	$M_D =$	87.7 ft-kips	
center of 12 strands to top fiber of beam at the end	=	7.00 in	
center of 12 strands to bottom fiber of beam at the harp point	=	11.00 in	
center of 12 strands and top fiber of beam at transfer length	=	9.84 in	
center of gravity of 32 strands and bottom fiber of beam	=	3.98 in	
center of gravity of all strands and the bottom fiber of beam at transfer length	=	15.24 in	
center of gravity of all strands and the bottom fiber of beam at the end	=	15.30 in	
Eccentricity of the strand group at transfer length:	$e_n =$	28.43 in	}
Eccentricity at end of beam:	$e =$	28.37 in	

$$f_t = \frac{P_i}{A} - \frac{P_i e}{S_t} + \frac{M_D}{S_t}$$

$$f_b = \frac{P_i}{A} + \frac{P_i e}{S_b} - \frac{M_D}{S_b}$$

		at midspan	at endspan	
Top stress at top fiber of beam	$f_t =$	-0.382 ksi	-0.386 ksi	OK
Bottom stress at bottom fiber of the beam	$f_b =$	2.833 ksi	2.833 ksi	OK

#### STRESSES AT HARP POINT

Bending moment due to beam weight at 0.3L	$M_D =$	1188.0 ft-kips	
Top stress at top fiber of beam	$f_t =$	-0.057 ksi	-0.065 ksi
Bottom stress at bottom fiber of the beam	$f_b =$	2.542 ksi	2.300 ksi

#### STRESSES AT MIDSPAN

Bending moment due to beam weight at 0.5L	$M_D =$	1414.3 ft-kips	
Top stress at top fiber of beam	$f_t =$	0.037 ksi	0.111 ksi
Bottom stress at bottom fiber of the beam	$f_b =$	2.360 ksi	2.117 ksi

#### HOLD-DOWN FORCES

assume stress in strand before losses =  $0.8f_u$

layer 1	=	75.0 ksi
layer 2	=	204.6 ksi
layer 3	=	227.4 ksi
layer 4	=	227.4 ksi
layer 5	=	227.4 ksi
layer 6	=	227.4 ksi
layer 7	=	227.4 ksi
layer 8	=	227.4 ksi
layer 9	=	227.4 ksi
layer 10	=	227.4 ksi
layer 11	=	227.4 ksi
layer 12	=	227.4 ksi
layer 13	=	227.4 ksi
layer 14	=	227.4 ksi

prestress force per strand before any losses:

layer 1	=	6.4 kips
layer 2	=	17.4 kips
layer 3	=	19.3 kips
layer 4	=	19.3 kips
layer 5	=	19.3 kips
layer 6	=	19.3 kips
layer 7	=	19.3 kips
layer 8	=	19.3 kips
layer 9	=	19.3 kips
layer 10	=	19.3 kips
layer 11	=	19.3 kips
layer 12	=	19.3 kips
layer 13	=	19.3 kips
layer 14	=	19.3 kips
Harp Angle	$\psi =$	7.2 °

Hold-down force/strand

layer 1	=	0.8 kips/strand
layer 2	=	2.3 kips/strand
layer 3	=	2.5 kips/strand
layer 4	=	2.5 kips/strand
layer 5	=	2.5 kips/strand
layer 6	=	2.5 kips/strand
layer 7	=	2.5 kips/strand
layer 8	=	2.5 kips/strand
layer 9	=	2.5 kips/strand
layer 10	=	2.5 kips/strand
layer 11	=	2.5 kips/strand
layer 12	=	2.5 kips/strand
layer 13	=	2.5 kips/strand
layer 14	=	2.5 kips/strand
Total hold-down force	=	30.45 kips

**Stresses at Service Loads**

**STRESS LIMITS FOR CONCRETE**

**Compression:**

Due to permanent loads for load combination Service I

for the precast beam	=	1.980 ksi
for deck	=	1.800 ksi

Due to permanent and transient loads for load combination Service I

for the precast beam	=	2.640 ksi
for deck	=	2.400 ksi

**Tension:**

Load Combination Service III

for the precast beam	=	-0.013 ksi
----------------------	---	------------

**STRESSES AT MIDSPAN**

Compression stresses at top fiber of beam	at midspan	at endspan	
$f_t = \frac{P_{pe}}{A} - \frac{P_{pe}e}{S_t} + \frac{(M_D + M_{D1})}{S_t} + \frac{(M_w + M_D)}{S_{tr}}$			
Due to permanent loads	$f_{tD} =$	1.917 ksi	1.910 ksi
			OK
$f_{tw} = \frac{P_{pe}}{A} - \frac{P_{pe}e}{S_t} + \frac{(M_D + M_{D1})}{S_t} + \frac{(M_w - M_D)}{S_{tr}} + \frac{(M_{D2+1})}{S_{tr}}$			
Due to permanent loads and transient loads	$f_{tw} =$	2.283 ksi	2.275 ksi
			OK
Compression stresses at top fiber of deck	at midspan	at endspan	
$f_{tw} = \frac{(M_w + M_D)}{S_{tr}}$			
Due to permanent loads	$f_{tw} =$	0.056 ksi	0.056 ksi
			OK
$f_{tw} = \frac{(M_w + M_D + M_{D2+1})}{S_{tr}}$			
Due to permanent loads and transient loads	$f_{tw} =$	0.644 ksi	0.644 ksi
			OK
Tension stresses at top fiber of deck	at midspan	at endspan	
$f_{tw} = \frac{P_{pe}}{A} - \frac{P_{pe}e}{S_t} - \frac{(M_D + M_{D1})}{S_t} - \frac{(M_w + M_D - 2.8 * M_{D2+1})}{S_{tr}}$			
Load Combination Service III	$f_{tw} =$	-1.719 ksi	-1.694 ksi
			OK

### Strength Limit State

POSITIVE MOMENT SECTION		
$M_u = 1.25DC+1.5DW+1.75(LL+IM)$	$M_u =$	8381.5 ft-kips
effective length factor for compression members		
layer 1	k =	0.00
layer 2	k =	0.11
layer 3	k =	0.27
layer 4	k =	0.27
layer 5	k =	0.27
layer 6	k =	0.27
layer 7	k =	0.27
layer 8	k =	0.27
layer 9	k =	0.27
layer 10	k =	0.27
layer 11	k =	0.27
layer 12	k =	0.27
layer 13	k =	0.27
layer 14	k =	0.27
	c =	3.9 ft-kips

average stress in prestressing steel

layer 1	$f_{ps} =$	93.8 ksi
layer 2	$f_{ps} =$	255.8 ksi
layer 3	$f_{ps} =$	284.2 ksi
layer 4	$f_{ps} =$	284.2 ksi
layer 5	$f_{ps} =$	284.2 ksi
layer 6	$f_{ps} =$	284.2 ksi
layer 7	$f_{ps} =$	284.2 ksi
layer 8	$f_{ps} =$	284.2 ksi
layer 9	$f_{ps} =$	284.2 ksi
layer 10	$f_{ps} =$	284.2 ksi
layer 11	$f_{ps} =$	284.2 ksi
layer 12	$f_{ps} =$	284.2 ksi
layer 13	$f_{ps} =$	284.2 ksi
layer 14	$f_{ps} =$	284.2 ksi

nominal flexure resistance

	a =	3.28 in	
$M_r = \Phi M_n, \Phi = 1.00$	$\Phi M_n =$	7742.5 ft-kips	NOT OK
M=DC+W+LL+IM	M =	5833.6 ft-kips	OK

NEGATIVE MOMENT SECTION		
$M_u = 1.25DC+1.5DW+1.75(LL+IM)$	$M_u =$	4837.2 ft-kips
	a =	9.12 in
	$\Phi M_n =$	4766.4 ft-kips
M=DC+W+LL+IM	M =	2869.7 ft-kips

NOT OK  
OK

### Shear Design

CRITICAL SECTION AT 0.59		
$V_u = 1.25DC+1.5DW+1.75(LL+IM)$	$V_u =$	405.0 kips
$M_u = 1.25DC+1.5DW+1.75(LL+IM)$	$M_u =$	-2684.4 ft-kips
or		
$V_u = 1.25DC+1.5DW+1.75(LL+IM)$	$V_u =$	364.8 kips
$M_u = 1.25DC+1.5DW+1.75(LL+IM)$	$M_u =$	-2877.0 ft-kips
max shear	$V_u =$	405.0 kips
max moment	$M_u =$	2877.0 ft-kips
Shear depth	$d_v =$	73.19 in
Applied factored normal force at the section	$N_u =$	0
Angle of diagonal compressive stresses	$\theta =$	36.00 °

**STRAIN IN FLEXURAL TENSION REINFORCEMENT**

$$\epsilon_x = \frac{\frac{M_x}{I_y} + 0.5M_x + 0.5M_x \cot \theta \cdot A_{ps} f_{ps}}{E_c A_c + E_p A_{ps}} \leq 0.002$$

		at midspan	at endspan
resultant compressive stress at centroid	$f_{pc} =$	0.493 ksi	0.494 ksi
effective stress in prestressing strand after all losses			
layer 1	$f_{po} =$	30.3 ksi	31.4 ksi
layer 2	$f_{po} =$	151.5 ksi	152.6 ksi
layer 3	$f_{po} =$	172.8 ksi	173.9 ksi
layer 4	$f_{po} =$	172.8 ksi	173.9 ksi
layer 5	$f_{po} =$	172.8 ksi	
layer 6	$f_{po} =$	173.0 ksi	
layer 7	$f_{po} =$	173.2 ksi	
layer 8	$f_{po} =$	173.1 ksi	
layer 9	$f_{po} =$		174.2 ksi
layer 10	$f_{po} =$		174.8 ksi
layer 11	$f_{po} =$		174.8 ksi
layer 12	$f_{po} =$		174.8 ksi
layer 13	$f_{po} =$		174.8 ksi
layer 14	$f_{po} =$		174.8 ksi
strain in flexural tension		at midspan	at endspan
layer 1	$\epsilon_x =$	0.002000	0.002000
layer 2	$\epsilon_x =$	0.002000	0.002000
layer 3	$\epsilon_x =$	0.002000	0.002000
layer 4	$\epsilon_x =$	0.002000	0.002000
layer 5	$\epsilon_x =$	0.002000	
layer 6	$\epsilon_x =$	0.002000	
layer 7	$\epsilon_x =$	0.002000	
layer 8	$\epsilon_x =$	0.002000	
layer 9	$\epsilon_x =$		0.002000
layer 10	$\epsilon_x =$		0.002000
layer 11	$\epsilon_x =$		0.002000
layer 12	$\epsilon_x =$		0.002000
layer 13	$\epsilon_x =$		0.002000
layer 14	$\epsilon_x =$		0.002000

**Deflection and Camber**

		at midspan	at endspan
Deflection due to Prestressing Force at Transfer	$\Delta_p =$	3.35 in	3.29 in
Deflection due to Beam Self-Weight at Transfer	$\Delta_g =$	-2.07 in	
Deflection due to Beam Self-Weight at Erection	$\Delta_g =$	-2.24 in	
Deflection due to Haunch and Deck	$\Delta_s =$	-3.43 in	
Deflection due to total self weight	$\Delta_{sw} =$	-2.32 in	
Total Deflection at transfer	$\Delta =$	1.28 in	1.22 in
Total Deflection at erection	$\Delta =$	1.89 in	1.78 in
Live load deflection limit = span/800	$=$	-1.80 in	
Deflection due to live load and impact	$\Delta_L =$	-1.35 in	
Deflection due to fire truck	$\Delta_L =$	-2.5431 in	
Total Deflection after fire with fire truck	$\Delta =$	-1.5090 in	

OK

NOT OK

**Parametric Design: I-5 Overpass Case Study**  
**Beam Design: 1/2" Strand**  
**Fire Exposure Status: Undamaged**

(PCI Bridge Design Manual Section 9.6)



**Material Properties**

CAST-IN-PLACE SLAB		
Actual Thickness	$t_{as} =$	8.0 in
Wearing Surface	$=$	0.5 in
Structural thickness = Actual - Wearing Surface	$t_s =$	7.5 in
Compressive Strength	$f'_c =$	4.00 ksi
Unit Weight	$w_c =$	150.0 pcf
Stress factor of compression block	$\beta_1 =$	0.85

BEAMS: AASHTO-PCI, BT-72 BULB-TEE		
Strength at release	$f'_{ci} =$	5.5 ksi
Strength at 28 days	$f'_c =$	7 ksi
Unit Weight	$w_c =$	150.0 pcf
Overall Beam Length:		
@ end spans	$L =$	110 ft
@ center span	$L =$	119 ft
Design Spans:		
Non-composite beam @ end spans	$L =$	109 ft
Non-composite beam @ center span	$L =$	118 ft
Composite beam @ end spans	$L =$	110 ft
Composite beam @ center span	$L =$	120 ft
Beam Spacing	$S =$	12 ft





**PRESTRESSING STRANDS**

Diameter of single strand	d =	0.5 in
Area of single strand	A =	0.153 in <sup>2</sup>

Temperature of Layer

layer 1 (bottom)	T =	68.00 °F
layer 2	T =	68.00 °F
layer 3	T =	68.00 °F
layer 4	T =	68.00 °F
layer 5	T =	68.00 °F
layer 6	T =	68.00 °F
layer 7	T =	68.00 °F
layer 8	T =	68.00 °F
layer 9	T =	68.00 °F
layer 10	T =	68.00 °F
layer 11	T =	68.00 °F
layer 12	T =	68.00 °F
layer 13	T =	68.00 °F
layer 14	T =	68.00 °F

Ultimate Strength

initial = 277 ksi

layer 1 (bottom)	$f_{pu}$ =	277 ksi
layer 2	$f_{pu}$ =	277 ksi
layer 3	$f_{pu}$ =	277 ksi
layer 4	$f_{pu}$ =	277 ksi
layer 5	$f_{pu}$ =	277 ksi
layer 6	$f_{pu}$ =	277 ksi
layer 7	$f_{pu}$ =	277 ksi
layer 8	$f_{pu}$ =	277 ksi
layer 9	$f_{pu}$ =	277 ksi
layer 10	$f_{pu}$ =	277 ksi
layer 11	$f_{pu}$ =	277 ksi
layer 12	$f_{pu}$ =	277 ksi
layer 13	$f_{pu}$ =	277 ksi
layer 14	$f_{pu}$ =	277 ksi

Yield Strength

initial = 250 ksi

layer 1 (bottom)	$f_{py}$ =	250 ksi
layer 2	$f_{py}$ =	250 ksi
layer 3	$f_{py}$ =	250 ksi
layer 4	$f_{py}$ =	250 ksi
layer 5	$f_{py}$ =	250 ksi
layer 6	$f_{py}$ =	250 ksi
layer 7	$f_{py}$ =	250 ksi
layer 8	$f_{py}$ =	250 ksi
layer 9	$f_{py}$ =	250 ksi
layer 10	$f_{py}$ =	250 ksi
layer 11	$f_{py}$ =	250 ksi
layer 12	$f_{py}$ =	250 ksi
layer 13	$f_{py}$ =	250 ksi
layer 14	$f_{py}$ =	250 ksi

Stress Limits:

before transfer  $\leq 0.75f_{pu}$  (initial = 207.6)

layer 1 (bottom)	$f_{pi}$ =	207.6 ksi
layer 2	$f_{pi}$ =	207.6 ksi
layer 3	$f_{pi}$ =	207.6 ksi
layer 4	$f_{pi}$ =	207.6 ksi
layer 5	$f_{pi}$ =	207.6 ksi
layer 6	$f_{pi}$ =	207.6 ksi
layer 7	$f_{pi}$ =	207.6 ksi
layer 8	$f_{pi}$ =	207.6 ksi
layer 9	$f_{pi}$ =	207.6 ksi
layer 10	$f_{pi}$ =	207.6 ksi
layer 11	$f_{pi}$ =	207.6 ksi
layer 12	$f_{pi}$ =	207.6 ksi
layer 13	$f_{pi}$ =	207.6 ksi
layer 14	$f_{pi}$ =	207.6 ksi

at service limit state (after all losses)  $\leq 0.80f_{py}$  (initial = 199.7)

layer 1 (bottom)	$f_{ps} =$	199.7 ksi
layer 2	$f_{ps} =$	199.7 ksi
layer 3	$f_{ps} =$	199.7 ksi
layer 4	$f_{ps} =$	199.7 ksi
layer 5	$f_{ps} =$	199.7 ksi
layer 6	$f_{ps} =$	199.7 ksi
layer 7	$f_{ps} =$	199.7 ksi
layer 8	$f_{ps} =$	199.7 ksi
layer 9	$f_{ps} =$	199.7 ksi
layer 10	$f_{ps} =$	199.7 ksi
layer 11	$f_{ps} =$	199.7 ksi
layer 12	$f_{ps} =$	199.7 ksi
layer 13	$f_{ps} =$	199.7 ksi
layer 14	$f_{ps} =$	199.7 ksi

Modulus of Elasticity

initial = 25982 ksi

layer 1 (bottom)	E =	25982.0 ksi
layer 2	E =	25982.0 ksi
layer 3	E =	25982.0 ksi
layer 4	E =	25982.0 ksi
layer 5	E =	25982.0 ksi
layer 6	E =	25982.0 ksi
layer 7	E =	25982.0 ksi
layer 8	E =	25982.0 ksi
layer 9	E =	25982.0 ksi
layer 10	E =	25982.0 ksi
layer 11	E =	25982.0 ksi
layer 12	E =	25982.0 ksi
layer 13	E =	25982.0 ksi
layer 14	E =	25982.0 ksi

### MILD STEEL REINFORCING BARS

Yield Strength

Layer 1 (Bottom)	$f_y =$	60.0 ksi	68.00 °F
Layer 2 (Top)	$f_y =$	60.0 ksi	68.00 °F

Modulus of Elasticity

E =	29000.0 ksi
-----	-------------

Layer 1 (Bottom)

Area of steel at midspan (effective flange)	$A_{sm} =$	2.79 in <sup>2</sup>
Area of steel at endspan (effective flange)	$A_{se} =$	2.48 in <sup>2</sup>
Area of temperature and shrinkage steel (12" width)	$A_s =$	0.31 in <sup>2</sup>

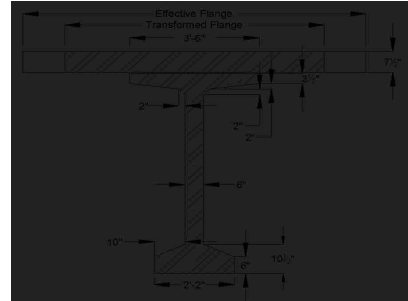
Layer 2 (Top)

Area of steel at midspan (effective flange)	$A_{sm} =$	12.6 in <sup>2</sup>
Area of steel at endspan (effective flange)	$A_{se} =$	12.4 in <sup>2</sup>
Area of temperature and shrinkage steel (12" width)	$A_s =$	0.2 in <sup>2</sup>

### Cross-sectional Properties

#### NON-COMPOSITE BEAM

Area of cross-section of beam	A =	767.0 in <sup>2</sup>
Overall depth of beam	H =	72.0 in
Moment of Inertia	I =	539,947 in <sup>4</sup>
Distance from centroid to extreme bottom fiber	$y_b =$	36.6 in
Distance from centroid to extreme top fiber	$y_t =$	35.4 in
Section modulus for the extreme bottom fiber	$S_b =$	14915.0 in <sup>3</sup>
Section modulus for the extreme top fiber	$S_t =$	15421.0 in <sup>3</sup>
Weight	$W_t =$	799.0 plf
Modulus of Elasticity = $33000 \cdot (W_c^{1.5}) \cdot (\sqrt{f_c})$		
cast-in-place concrete deck	$E_{cs} =$	3834 ksi
precast beam at release	$E_{ci} =$	4496 ksi
precast beam at service loads	$E_c =$	5072 ksi



### COMPOSITE BEAM AT MIDSPAN

Effective Flange Width	$b_f =$	111.0 in	*min of three criteria
Modular Ratio = $E_{cs}/E_c$	$n =$	0.7559	
Transformed flange width	$=$	83.9 in	
Transformed flange area	$=$	629.3 in <sup>2</sup>	
Transformed haunch width	$=$	31.7 in	
Transformed haunch area	$=$	15.9 in <sup>2</sup>	
Deck-distance to top fiber	$y_t =$	3.75 in	

	Transformed Area	$y_b$	$Ay_b$	$A(y_{bc}-y_b)^2$	$I$	$I + A(y_{bc}-y_b)^2$
Beam	767.0 in <sup>2</sup>	36.60 in	28,072.2 in <sup>3</sup>	250,443 in <sup>4</sup>	539,947 in <sup>4</sup>	790,390 in <sup>4</sup>
Haunch	15.9 in <sup>2</sup>	72.25 in	1,146.9 in <sup>3</sup>	4,906 in <sup>4</sup>	0.33 in <sup>4</sup>	4,906 in <sup>4</sup>
Deck	629.3 in <sup>2</sup>	76.25 in	47,985.0 in <sup>3</sup>	293,069 in <sup>4</sup>	2,950 in <sup>4</sup>	296,019 in <sup>4</sup>
Total	1412.2 in <sup>2</sup>		77,204.1 in <sup>3</sup>			1,091,316 in <sup>4</sup>

Total area of Composite Section	$A_c =$	1412 in <sup>2</sup>
Overall Depth of the Composite Section	$h_c =$	80 in
Moment of Inertia	$I_c =$	1,091,316 in <sup>4</sup>
Distance from centroid to extreme <u>bottom</u> fiber of beam	$y_{bc} =$	54.67 in
Distance from centroid to extreme <u>top</u> fiber of beam	$y_{tg} =$	17.33 in
Distance from centroid to extreme <u>top</u> fiber of slab	$y_{tc} =$	25.33 in
Section modulus for the extreme <u>bottom</u> fiber of beam	$S_{bc} =$	19,961.9 in <sup>3</sup>
Section modulus for the extreme <u>top</u> fiber of beam	$S_{tg} =$	62,972.4 in <sup>3</sup>
Section modulus for the extreme <u>top</u> fiber slab	$S_{tc} =$	56,994.5 in <sup>3</sup>

### COMPOSITE BEAM AT ENDSPAN

Effective Flange Width	$b_f =$	106.6 in	*min of three criteria
Modular Ratio = $E_{cs}/E_c$	$n =$	0.7559	
Transformed flange width	$=$	80.6 in	
Transformed flange area	$=$	604.4 in <sup>2</sup>	
Transformed haunch width	$=$	31.7 in	
Transformed haunch area	$=$	15.9 in <sup>2</sup>	
Deck-distance to top fiber	$y_{td} =$	3.75 in	

	Transformed Area	$y_t$	$Ay_t$	$A(y_{bc}-y_t)^2$	$I$	$I + A(y_{tc}-y_t)^2$
Beam	767.0 in <sup>2</sup>	36.60 in	28,072.2 in <sup>3</sup>	273,455 in <sup>4</sup>	539,947 in <sup>4</sup>	813,402 in <sup>4</sup>
Haunch	15.9 in <sup>2</sup>	72.25 in	1,146.9 in <sup>3</sup>	5,660 in <sup>4</sup>	0.33 in <sup>4</sup>	5,660 in <sup>4</sup>
Deck	604.4 in <sup>2</sup>	76.25 in	46,082.8 in <sup>3</sup>	215,472 in <sup>4</sup>	2,833 in <sup>4</sup>	218,305 in <sup>4</sup>
Total	1387.2 in <sup>2</sup>		75,302.0 in <sup>3</sup>			1,037,366 in <sup>4</sup>

Total area of Composite Section	$A_c =$	1387 in <sup>2</sup>
Overall Depth of the Composite Section	$h_c =$	80 in
Moment of Inertia	$I_c =$	1,037,366 in <sup>4</sup>
Distance from centroid to extreme <u>bottom</u> fiber of beam	$y_{bc} =$	54.28 in
Distance from centroid to extreme <u>top</u> fiber of beam	$y_{tg} =$	17.72 in
Distance from centroid to extreme <u>top</u> fiber of slab	$y_{tc} =$	25.72 in
Section modulus for the extreme <u>bottom</u> fiber of beam	$S_{bc} =$	19,110.7 in <sup>3</sup>
Section modulus for the extreme <u>top</u> fiber of beam	$S_{tg} =$	58,548.3 in <sup>3</sup>
Section modulus for the extreme <u>top</u> fiber slab	$S_{tc} =$	40,336.0 in <sup>3</sup>

### Shear Forces and Bending Moments

#### DEAD LOADS

Beam self-weight	$w_{beam} =$	0.799 k/f
8 in. deck weight	$w_{deck} =$	1.200 k/f
1/2 in. haunch weight	$w_{haunch} =$	0.022 k/f

#### LRFD Specifications: Art. 4.6.2.2.1

Width of Deck Constant		OK
Number of beams is not less than four $N_b =$	4	OK
Roadway part of the overhang, $d_o \leq 3.0$ ft, $d_o =$	1.5	OK
Curvature in plans is less than $4^\circ =$	0	OK
Cross-section of the bridge is consistent with one of the cross sections given by LRFD specs		OK

Barrier and wearing surface loads are equally distributed among the 4 beams

Barrier Wt	$W_t =$	0.150 k/f
Dead load of future wearing surface	$DW =$	0.263 k/f

LIVE LOADS		
Fire truck live load front load (Point A)	$P_{live} =$	48.0 kips
Fire truck live load back load (Point B)	$P_{live} =$	22.0 kips
distance between two loads		19.2 ft
distance from nearest edge to point A	$x_a =$	59.0 ft
distance from nearest edge to point B	$x_b =$	39.8 ft
LRFD Specifications: Art. 4.6.2.2.1		
Width of Deck Constant		OK
Number of beams is not less than four $N_b =$	4	OK
Beams are parallel and approximately of the same stiffness		OK
Roadway part of the overhang, $d_o \leq 3.0$ ft, $d_o =$	1.5	OK
Curvature in plans is less than $4^\circ =$	0	OK

Barrier and wearing surface loads are equally distributed among the 4 beams

Bridge Type-- "k" (LRFD Table 4.6.2.2.1-1)		
Number of design lanes = $w/12$	=	3 lanes

**Distribution Factor for Bending Moment:**

Beams spacing	$S =$	12.0 ft
Depth of concrete slab	$t_s =$	7.5 in
Beam Span	$L =$	120.0 ft
Number of Beams	$N_b =$	4
Modular ratio between beam & deck materials	$n =$	1.3229
Longitudinal stiffness parameter	$K_g =$	2,309,429.79 in <sup>4</sup>

at center span:		
$DFM = 0.75 + \left(\frac{S}{9.5}\right)^{0.6} * \left(\frac{S}{L}\right)^{0.2} * \left(\frac{K_g}{12 * L * t_s^3}\right)^{0.1}$		
	DFM =	0.905 lanes/beam

0.905 Controls

one design lane loaded:		
$DFM = 0.75 + \left(\frac{S}{14}\right)^{0.4} * \left(\frac{S}{L}\right)^{0.2} * \left(\frac{K_g}{12 * L * t_s^3}\right)^{0.1}$		
	DFM =	0.614 lanes/beam

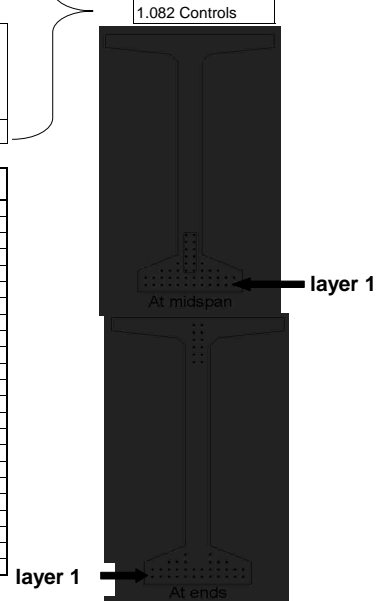
**Distribution Factor for Shear Force**

both end spans and center span:		
$DFV = 0.2 + \left(\frac{S}{12}\right) - \left(\frac{S}{35}\right)^2$		
	DFV =	1.082 lanes/beam

1.082 Controls

one design lane loaded:		
$DFV = 0.36 + \left(\frac{S}{25}\right)$		
	DFV =	0.840 lanes/beam

	At Midspan		At Ends	
from bottom	No. of	Distance from Bottom	No. of	Distance from Bottom
layer 1	12	2	12	2
layer 2	12	4	12	4
layer 3	8	6	6	6
layer 4	4	8	2	8
layer 5	2	10	-	-
layer 6	2	12	-	-
layer 7	2	14	-	-
layer 8	2	16	-	-
layer 9	-	-	2	60
layer 10	-	-	2	62
layer 11	-	-	2	64
layer 12	-	-	2	66
layer 13	-	-	2	68
layer 14	-	-	2	70
<b>Harped Strand Group (included in above totals)</b>				
layer 3	2	6		
layer 4	2	8		
layer 5	2	10		
layer 6	2	12		
layer 7	2	14		
layer 8	2	16		



distance from the center of gravity of strands to the bottom fiber of the beam = 7% of the beam depth  
strand eccentricity at midspan =  $(y_t - y_{bs})$

$y_{bs} =$	5.82 in
$e_c =$	30.78 in

### Prestress Losses

#### ELASTIC SHORTENING

assumed loss	=	9.00%
Force per strand at transfer		
layer 1	=	28.9 kips
layer 2	=	28.9 kips
layer 3	=	28.9 kips
layer 4	=	28.9 kips
layer 5	=	28.9 kips
layer 6	=	28.9 kips
layer 7	=	28.9 kips
layer 8	=	28.9 kips
layer 9	=	28.9 kips
layer 10	=	28.9 kips
layer 11	=	28.9 kips
layer 12	=	28.9 kips
layer 13	=	28.9 kips
layer 14	=	28.9 kips

Total prestressing force at release	$P_i =$	at midspan 1271.6 kips	at endspan 1271.6 kips
	Sum of concrete stresses at the center of gravity of prestressing tendons due to prestressing force at transfer and the self-weight of the member at sections of maximum moment $f_{cgp} =$	2.938 ksi	2.938 ksi
Loss due to shortening		at midspan	at endspan
	layer 1	$\Delta f_{pES} =$ 17.0 ksi	17.0 ksi
	layer 2	$\Delta f_{pES} =$ 17.0 ksi	17.0 ksi
	layer 3	$\Delta f_{pES} =$ 17.0 ksi	17.0 ksi
	layer 4	$\Delta f_{pES} =$ 17.0 ksi	17.0 ksi
	layer 5	$\Delta f_{pES} =$ 17.0 ksi	
	layer 6	$\Delta f_{pES} =$ 17.0 ksi	
	layer 7	$\Delta f_{pES} =$ 17.0 ksi	
	layer 8	$\Delta f_{pES} =$ 17.0 ksi	
	layer 9	$\Delta f_{pES} =$	17.0 ksi
	layer 10	$\Delta f_{pES} =$	17.0 ksi
	layer 11	$\Delta f_{pES} =$	17.0 ksi
	layer 12	$\Delta f_{pES} =$	17.0 ksi
	layer 13	$\Delta f_{pES} =$	17.0 ksi
	layer 14	$\Delta f_{pES} =$	17.0 ksi

#### SHRINKAGE

Shrinkage = $(17 - 0.15 \cdot \text{Relative Humidity})$	$\Delta f_{PSR} =$	6.5 ksi	← assume relative humidity = 70%
--	--------------------	---------	----------------------------------

#### CREEP OF CONCRETE

Change of stresses at center of gravity of prestressing due to permanent loads except the loads acting at time of applying prestressing force, calculated at the same section as $f_{cgp}$	$\Delta f_{cgp} =$	1.563 ksi	
	loss due to creep	$\Delta f_{PCR} =$	at midspan 24.3 ksi      at endspan 24.3 ksi

**RELAXATION OF PRESTRESSING STRANDS**

loss due to relaxation after transfer		at midspan	at endspan
layer 1	$\Delta f_{pR2} =$	2.1 ksi	2.1 ksi
layer 2	$\Delta f_{pR2} =$	2.1 ksi	2.1 ksi
layer 3	$\Delta f_{pR2} =$	2.1 ksi	2.1 ksi
layer 4	$\Delta f_{pR2} =$	2.1 ksi	2.1 ksi
layer 5	$\Delta f_{pR2} =$	2.1 ksi	
layer 6	$\Delta f_{pR2} =$	2.1 ksi	
layer 7	$\Delta f_{pR2} =$	2.1 ksi	
layer 8	$\Delta f_{pR2} =$	2.1 ksi	
layer 9	$\Delta f_{pR2} =$		2.1 ksi
layer 10	$\Delta f_{pR2} =$		2.1 ksi
layer 11	$\Delta f_{pR2} =$		2.1 ksi
layer 12	$\Delta f_{pR2} =$		2.1 ksi
layer 13	$\Delta f_{pR2} =$		2.1 ksi
layer 14	$\Delta f_{pR2} =$		2.1 ksi

**TOTAL LOSSES AT TRANSFER**

total loss  $\Delta f_{pES} = \Delta f_{pi}$

stress in tendons after transfer  $f_{pt} = f_{pi} - \Delta f_{pi}$

		at midspan	at endspan
layer 1	$f_{pt} =$	190.6 ksi	190.6 ksi
layer 2	$f_{pt} =$	190.6 ksi	190.6 ksi
layer 3	$f_{pt} =$	190.6 ksi	190.6 ksi
layer 4	$f_{pt} =$	190.6 ksi	190.6 ksi
layer 5	$f_{pt} =$	190.6 ksi	
layer 6	$f_{pt} =$	190.6 ksi	
layer 7	$f_{pt} =$	190.6 ksi	
layer 8	$f_{pt} =$	190.6 ksi	
layer 9	$f_{pt} =$		190.6 ksi
layer 10	$f_{pt} =$		190.6 ksi
layer 11	$f_{pt} =$		190.6 ksi
layer 12	$f_{pt} =$		190.6 ksi
layer 13	$f_{pt} =$		190.6 ksi
layer 14	$f_{pt} =$		190.6 ksi

force per strand =  $f_{pt} \times \text{strand area}$

		at midspan	at endspan
layer 1	=	29.2 kips	29.2 kips
layer 2	=	29.2 kips	29.2 kips
layer 3	=	29.2 kips	29.2 kips
layer 4	=	29.2 kips	29.2 kips
layer 5	=	29.2 kips	
layer 6	=	29.2 kips	
layer 7	=	29.2 kips	
layer 8	=	29.2 kips	
layer 9	=		29.2 kips
layer 10	=		29.2 kips
layer 11	=		29.2 kips
layer 12	=		29.2 kips
layer 13	=		29.2 kips
layer 14	=		29.2 kips
Total prestressing force after transfer	$P_1 =$	1284.8 kips	1284.8 kips

Initial loss =  $(\Delta f_{pi}) / (f_{pi})$

		at midspan	at endspan
layer 1	% =	8.2%	8.2%
layer 2	% =	8.2%	8.2%
layer 3	% =	8.2%	8.2%
layer 4	% =	8.2%	8.2%
layer 5	% =	8.2%	
layer 6	% =	8.2%	
layer 7	% =	8.2%	
layer 8	% =	8.2%	
layer 9	% =		8.2%
layer 10	% =		8.2%
layer 11	% =		8.2%
layer 12	% =		8.2%
layer 13	% =		8.2%
layer 14	% =		8.2%

OK  
OK  
OK  
OK  
OK  
OK  
OK  
OK  
OK  
OK  
OK  
OK  
OK  
OK

**TOTAL LOSSES AT SERVICE LOADS**

Total Losses		at midspan	at endspan
layer 1	$\Delta f_{pT} =$	49.9 ksi	49.9 ksi
layer 2	$\Delta f_{pT} =$	49.9 ksi	49.9 ksi
layer 3	$\Delta f_{pT} =$	49.9 ksi	49.9 ksi
layer 4	$\Delta f_{pT} =$	49.9 ksi	49.9 ksi
layer 5	$\Delta f_{pT} =$	49.9 ksi	
layer 6	$\Delta f_{pT} =$	49.9 ksi	
layer 7	$\Delta f_{pT} =$	49.9 ksi	
layer 8	$\Delta f_{pT} =$	49.9 ksi	
layer 9	$\Delta f_{pT} =$		49.9 ksi
layer 10	$\Delta f_{pT} =$		49.9 ksi
layer 11	$\Delta f_{pT} =$		49.9 ksi
layer 12	$\Delta f_{pT} =$		49.9 ksi
layer 13	$\Delta f_{pT} =$		49.9 ksi
layer 14	$\Delta f_{pT} =$		49.9 ksi

Stress in tendon after all losses =  $f_{pe} - \Delta f_{pT}$

		at midspan	at endspan
layer 1	$f_{pe} =$	157.7 ksi	157.7 ksi
layer 2	$f_{pe} =$	157.7 ksi	157.7 ksi
layer 3	$f_{pe} =$	157.7 ksi	157.7 ksi
layer 4	$f_{pe} =$	157.7 ksi	157.7 ksi
layer 5	$f_{pe} =$	157.7 ksi	
layer 6	$f_{pe} =$	157.7 ksi	
layer 7	$f_{pe} =$	157.7 ksi	
layer 8	$f_{pe} =$	157.7 ksi	
layer 9	$f_{pe} =$		157.7 ksi
layer 10	$f_{pe} =$		157.7 ksi
layer 11	$f_{pe} =$		157.7 ksi
layer 12	$f_{pe} =$		157.7 ksi
layer 13	$f_{pe} =$		157.7 ksi
layer 14	$f_{pe} =$		157.7 ksi

check prestressing stress limit at service limit state:  $f_{pe} \leq 0.8 \cdot f_{py}$

layer 1	=	199.7 ksi
layer 2	=	199.7 ksi
layer 3	=	199.7 ksi
layer 4	=	199.7 ksi
layer 5	=	199.7 ksi
layer 6	=	199.7 ksi
layer 7	=	199.7 ksi
layer 8	=	199.7 ksi
layer 9	=	199.7 ksi
layer 10	=	199.7 ksi
layer 11	=	199.7 ksi
layer 12	=	199.7 ksi
layer 13	=	199.7 ksi
layer 14	=	199.7 ksi

OK  
OK  
OK  
OK  
OK  
OK  
OK  
OK  
OK  
OK  
OK  
OK  
OK  
OK

force per strand =  $f_{pe} \cdot \text{strand area}$

		at midspan	at endspan
layer 1	=	24.1 kips	24.1 kips
layer 2	=	24.1 kips	24.1 kips
layer 3	=	24.1 kips	24.1 kips
layer 4	=	24.1 kips	24.1 kips
layer 5	=	24.1 kips	
layer 6	=	24.1 kips	
layer 7	=	24.1 kips	
layer 8	=	24.1 kips	
layer 9	=		24.1 kips
layer 10	=		24.1 kips
layer 11	=		24.1 kips
layer 12	=		24.1 kips
layer 13	=		24.1 kips
layer 14	=		24.1 kips

Total prestressing force after all losses		at midspan	at endspan
	$P_{pe} =$	1061.6 kips	1061.6 kips

Final losses, % =  $(\Delta f_{PT})/f_{pi}$

layer 1	% =	24.0%	24.0%
layer 2	% =	24.0%	24.0%
layer 3	% =	24.0%	24.0%
layer 4	% =	24.0%	24.0%
layer 5	% =	24.0%	
layer 6	% =	24.0%	
layer 7	% =	24.0%	
layer 8	% =	24.0%	
layer 9	% =		24.0%
layer 10	% =		24.0%
layer 11	% =		24.0%
layer 12	% =		24.0%
layer 13	% =		24.0%
layer 14	% =		24.0%
Average final losses, %	% =	24.0%	24.0%

### Stresses at Transfer

#### STRESS LIMITS FOR CONCRETE

Compression = $0.6f_{ci}$	$f_{ci}$ =	3.300 ksi
Tension		
without bonded reinforcement = $-0.0948\sqrt{f_{ci}} \leq -0.2$	=	-0.200 ksi
with bonded auxiliary reinforcement = $-0.22\sqrt{f_{ci}}$	=	-0.016 ksi

#### STRESSES AT TRANSFER LENGTH SECTION

Transfer Length = $60 \times$ (strand diameter)	=	2.5 ft	} Calcs for eccentricity (see 9.6.7.2)
Bending moment at transfer length	$M_0$ =	116.4 ft-kips	
center of 12 strands to top fiber of beam at the end	=	7.00 in	
center of 12 strands to bottom fiber of beam at the harp point	=	11.00 in	
center of 12 strands and top fiber of beam at transfer length	=	10.78 in	
center of gravity of 32 strands and bottom fiber of beam	=	3.88 in	
center of gravity of all strands and the bottom fiber of beam at transfer length	=	19.51 in	
center of gravity of all strands and the bottom fiber of beam at the end	=	20.55 in	
Eccentricity of the strand group at transfer length:	$e_n$ =	17.09 in	
Eccentricity at end of beam:	$e$ =	16.05 in	

$$f_t = \frac{P_i}{A} - \frac{P_i e}{S_t} + \frac{M_x}{S_t}$$

$$f_b = \frac{P_i}{A} + \frac{P_i e}{S_b} - \frac{M_x}{S_b}$$

		at midspan	at endspan	
Top stress at top fiber of beam	$f_t$ =	0.342 ksi	0.342 ksi	OK
Bottom stress at bottom fiber of the beam	$f_b$ =	3.021 ksi	3.021 ksi	OK

#### STRESSES AT HARP POINT

Bending moment due to beam weight at 0.3L	$M_0$ =	1184.2 ft-kips		
Top stress at top fiber of beam	$f_t$ =	0.032 ksi	0.032 ksi	OK
Bottom stress at bottom fiber of the beam	$f_b$ =	3.300 ksi	3.300 ksi	OK

#### STRESSES AT MIDSPAN

Bending moment due to beam weight at 0.5L	$M_0$ =	1414.3 ft-kips		
Top stress at top fiber of beam	$f_t$ =	0.220 ksi	0.211 ksi	OK
Bottom stress at bottom fiber of the beam	$f_b$ =	3.144 ksi	3.189 ksi	OK

#### HOLD-DOWN FORCES

assume stress in strand before losses =  $0.8f_u$

layer 1	=	221.4 ksi
layer 2	=	221.4 ksi
layer 3	=	221.4 ksi
layer 4	=	221.4 ksi
layer 5	=	221.4 ksi
layer 6	=	221.4 ksi
layer 7	=	221.4 ksi
layer 8	=	221.4 ksi
layer 9	=	221.4 ksi
layer 10	=	221.4 ksi
layer 11	=	221.4 ksi
layer 12	=	221.4 ksi
layer 13	=	221.4 ksi
layer 14	=	221.4 ksi



prestress force per strand before any losses:

layer 1	=	33.9 kips
layer 2	=	33.9 kips
layer 3	=	33.9 kips
layer 4	=	33.9 kips
layer 5	=	33.9 kips
layer 6	=	33.9 kips
layer 7	=	33.9 kips
layer 8	=	33.9 kips
layer 9	=	33.9 kips
layer 10	=	33.9 kips
layer 11	=	33.9 kips
layer 12	=	33.9 kips
layer 13	=	33.9 kips
layer 14	=	33.9 kips
Harp Angle	$\psi =$	7.2 °

Hold-down force/strand

layer 1	=	4.4 kips/strand
layer 2	=	4.4 kips/strand
layer 3	=	4.4 kips/strand
layer 4	=	4.4 kips/strand
layer 5	=	4.4 kips/strand
layer 6	=	4.4 kips/strand
layer 7	=	4.4 kips/strand
layer 8	=	4.4 kips/strand
layer 9	=	4.4 kips/strand
layer 10	=	4.4 kips/strand
layer 11	=	4.4 kips/strand
layer 12	=	4.4 kips/strand
layer 13	=	4.4 kips/strand
layer 14	=	4.4 kips/strand
Total hold-down force	=	53.39 kips

### Stresses at Service Loads

#### STRESS LIMITS FOR CONCRETE

Compression:

Due to permanent loads for load combination Service I

for the precast beam	=	3.150 ksi
for deck	=	1.800 ksi

Due to permanent and transient loads for load combination Service I

for the precast beam	=	4.200 ksi
for deck	=	2.400 ksi

Tension:

Load Combination Service III

for the precast beam	=	-0.016 ksi
----------------------	---	------------

#### STRESSES AT MIDSPAN

Compression stresses at top fiber of beam	at midspan	at endspan	
$f_t = \frac{P_{pe}}{A} - \frac{P_{pe}e}{S_x} + \frac{(M_D + M_{L1})}{S_x} - \frac{(M_{ws} + M_D)}{S_{xy}}$			
Due to permanent loads	$f_{t1} =$	2.041 ksi	2.041 ksi
$f_{t2} = \frac{P_{pe}}{A} - \frac{P_{pe}e}{S_x} + \frac{(M_D + M_{L1})}{S_x} + \frac{(M_{ws} + M_D)}{S_{xy}} + \frac{(M_{LL1})}{S_{xy}}$			
Due to permanent loads and transient loads	$f_{t2} =$	2.444 ksi	2.444 ksi
Compression stresses at top fiber of deck	at midspan	at endspan	
$f_{tc} = \frac{(M_{ws} + M_D)}{S_{xt}}$			
Due to permanent loads	$f_{tc} =$	0.042 ksi	0.042 ksi
$f_{tc} = \frac{(M_{ws} + M_D + M_{LL1})}{S_{xt}}$			
Due to permanent loads and transient loads	$f_{tc} =$	0.488 ksi	0.488 ksi
Tension stresses at top fiber of deck	at midspan	at endspan	
$f_{tr} = \frac{P_{pe}}{A} + \frac{P_{pe}e}{S_y} - \frac{(M_D + M_{L1})}{S_y} - \frac{(M_{ws} + M_D + 0.8 * M_{LL1})}{S_{xt}}$			
Load Combination Service III	$f_{tr} =$	-0.393 ksi	-0.393 ksi

OK

OK

OK

OK

OK

**Strength Limit State**

**POSITIVE MOMENT SECTION**

$M_u = 1.25DC+1.5DW+1.75(LL+IM)$	$M_u =$	8381.5 ft-kips
effective length factor for compression members		
layer 1	k =	0.28
layer 2	k =	0.28
layer 3	k =	0.28
layer 4	k =	0.28
layer 5	k =	0.28
layer 6	k =	0.28
layer 7	k =	0.28
layer 8	k =	0.28
layer 9	k =	0.28
layer 10	k =	0.28
layer 11	k =	0.28
layer 12	k =	0.28
layer 13	k =	0.28
layer 14	k =	0.28
	c =	5.7 ft-kips

average stress in prestressing steel

layer 1	$f_{ps} =$	270.9 ksi
layer 2	$f_{ps} =$	270.9 ksi
layer 3	$f_{ps} =$	270.9 ksi
layer 4	$f_{ps} =$	270.9 ksi
layer 5	$f_{ps} =$	270.9 ksi
layer 6	$f_{ps} =$	270.9 ksi
layer 7	$f_{ps} =$	270.9 ksi
layer 8	$f_{ps} =$	270.9 ksi
layer 9	$f_{ps} =$	270.9 ksi
layer 10	$f_{ps} =$	270.9 ksi
layer 11	$f_{ps} =$	270.9 ksi
layer 12	$f_{ps} =$	270.9 ksi
layer 13	$f_{ps} =$	270.9 ksi
layer 14	$f_{ps} =$	270.9 ksi

nominal flexure resistance

	a =	4.85 in
$M_r = \Phi M_n, \Phi = 1.00$	$\Phi M_n =$	10906.2 ft-kips

OK

**NEGATIVE MOMENT SECTION**

$M_u = 1.25DC+1.5DW+1.75(LL+IM)$	$M_u =$	-4837.2 ft-kips
	a =	0.20 in
	$\Phi M_n =$	5099.1 ft-kips

OK

**Shear Design**

**CRITICAL SECTION AT 0.59**

$V_u = 1.25DC+1.5DW+1.75(LL+IM)$	$V_u =$	405.0 kips
$M_u = 1.25DC+1.5DW+1.75(LL+IM)$	$M_u =$	-2684.4 ft-kips
or		
$V_u = 1.25DC+1.5DW+1.75(LL+IM)$	$V_u =$	364.8 kips
$M_u = 1.25DC+1.5DW+1.75(LL+IM)$	$M_u =$	-2877.0 ft-kips
max shear	$V_u =$	405.0 kips
max moment	$M_u =$	2877.0 ft-kips
Shear depth	$d_v =$	73.19 in
Applied factored normal force at the section	$N_u =$	0
Angle of diagonal compressive stresses	$\theta =$	36.00 °

**STRAIN IN FLEXURAL TENSION REINFORCEMENT**

$$\epsilon_x = \frac{\frac{M}{d_v} + 0.5N_u + 0.5P_u \cot \theta - A_{ps}f_{po}}{E_s A_s + E_p A_{ps}} \leq 0.002$$

		at midspan	at endspan
resultant compressive stress at centroid	$f_{pc} =$	0.994 ksi	0.994 ksi
effective stress in prestressing strand after all losses			
layer 1	$f_{po} =$	162.8 ksi	162.8 ksi
layer 2	$f_{po} =$	162.8 ksi	162.8 ksi
layer 3	$f_{po} =$	162.8 ksi	162.8 ksi
layer 4	$f_{po} =$	162.8 ksi	162.8 ksi
layer 5	$f_{po} =$	162.8 ksi	
layer 6	$f_{po} =$	162.8 ksi	
layer 7	$f_{po} =$	162.8 ksi	
layer 8	$f_{po} =$	162.8 ksi	
layer 9	$f_{po} =$		162.8 ksi
layer 10	$f_{po} =$		162.8 ksi
layer 11	$f_{po} =$		162.8 ksi
layer 12	$f_{po} =$		162.8 ksi
layer 13	$f_{po} =$		162.8 ksi
layer 14	$f_{po} =$		162.8 ksi
strain in flexural tension		at midspan	at endspan
layer 1	$\epsilon_x =$	0.002000	0.002000
layer 2	$\epsilon_x =$	0.002000	0.002000
layer 3	$\epsilon_x =$	0.002000	0.002000
layer 4	$\epsilon_x =$	0.002000	0.002000
layer 5	$\epsilon_x =$	0.002000	
layer 6	$\epsilon_x =$	0.002000	
layer 7	$\epsilon_x =$	0.002000	
layer 8	$\epsilon_x =$	0.002000	
layer 9	$\epsilon_x =$		0.002000
layer 10	$\epsilon_x =$		0.002000
layer 11	$\epsilon_x =$		0.002000
layer 12	$\epsilon_x =$		0.002000
layer 13	$\epsilon_x =$		0.002000
layer 14	$\epsilon_x =$		0.002000

**Deflection and Camber**

		at midspan	at endspan
Deflection due to Prestressing Force at Transfer	$\Delta_p =$	3.97 in	3.97 in
Deflection due to Beam Self-Weight at Transfer	$\Delta_g =$	-1.49 in	
Deflection due to Beam Self-Weight at Erection	$\Delta_g =$	-1.44 in	
Deflection due to Haunch and Deck	$\Delta_g =$	-1.95 in	
Deflection due to total self weight	$\Delta_{sw} =$	0.59 in	
Total Deflection at transfer	$\Delta =$	2.48 in	2.48 in
Total Deflection at erection	$\Delta =$	4.49 in	4.49 in
Live load deflection limit = span/800	$=$	1.80 in	
Deflection due to live load and impact	$\Delta_L =$	-0.83 in	
Deflection due to fire truck	$\Delta_L =$	-0.7520 in	
Total Deflection after fire with fire truck	$\Delta =$	3.8033 in	

OK

OK

**Parametric Design: I-5 Overpass Case Study**  
**Beam Design: 1/2" Strand**  
**Fire Exposure Status: Damaged**

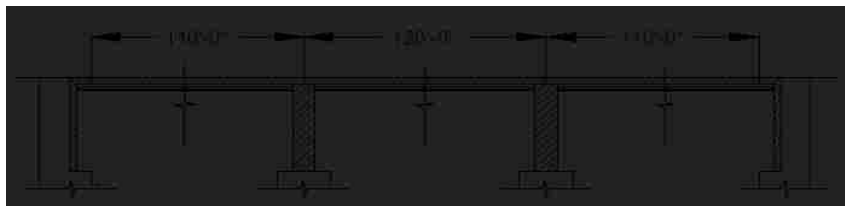
(PCI Bridge Design Manual Section 9.6)



**Material Properties**

CAST-IN-PLACE SLAB		
Actual Thickness	$t_{as} =$	8.0 in
Wearing Surface	=	0.5 in
Structural thickness = Actual - Wearing Surface	$t_s =$	7.5 in
Compressive Strength	$f_c =$	2.95 ksi
Unit Weight	$w_c =$	150.0 pcf
Stress factor of compression block	$\beta_1 =$	0.85

BEAMS: AASHTO-PCI, BT-72 BULB-TEE		
Strength at release	$f_{ci} =$	5.5 ksi
Strength at 28 days	$f_c =$	7 ksi
Unit Weight	$w_c =$	150.0 pcf
Overall Beam Length:		
@ end spans	$L =$	110 ft
@ center span	$L =$	119 ft
Design Spans:		
Non-composite beam @ end spans	$L =$	109 ft
Non-composite beam @ center span	$L =$	118 ft
Composite beam @ end spans	$L =$	110 ft
Composite beam @ center span	$L =$	120 ft
Beam Spacing	$S =$	12 ft



**PRESTRESSING STRANDS**

Diameter of single strand	d =	0.5 in
Area of single strand	A =	0.153 in <sup>2</sup>

Temperature of Layer	layer 1 (bottom)	T =	68.00 °F
	layer 2	T =	68.00 °F
	layer 3	T =	68.00 °F
	layer 4	T =	68.00 °F
	layer 5	T =	68.00 °F
	layer 6	T =	68.00 °F
	layer 7	T =	68.00 °F
	layer 8	T =	68.00 °F
	layer 9	T =	68.00 °F
	layer 10	T =	68.00 °F
	layer 11	T =	68.00 °F
	layer 12	T =	68.00 °F
	layer 13	T =	68.00 °F
	layer 14	T =	68.00 °F

Ultimate Strength initial = 277 ksi	layer 1 (bottom)	$f_{pu}$ =	277 ksi
	layer 2	$f_{pu}$ =	277 ksi
	layer 3	$f_{pu}$ =	277 ksi
	layer 4	$f_{pu}$ =	277 ksi
	layer 5	$f_{pu}$ =	277 ksi
	layer 6	$f_{pu}$ =	277 ksi
	layer 7	$f_{pu}$ =	277 ksi
	layer 8	$f_{pu}$ =	277 ksi
	layer 9	$f_{pu}$ =	277 ksi
	layer 10	$f_{pu}$ =	277 ksi
	layer 11	$f_{pu}$ =	277 ksi
	layer 12	$f_{pu}$ =	277 ksi
	layer 13	$f_{pu}$ =	277 ksi
	layer 14	$f_{pu}$ =	277 ksi

Yield Strength initial = 250 ksi	layer 1 (bottom)	$f_{py}$ =	250 ksi
	layer 2	$f_{py}$ =	250 ksi
	layer 3	$f_{py}$ =	250 ksi
	layer 4	$f_{py}$ =	250 ksi
	layer 5	$f_{py}$ =	250 ksi
	layer 6	$f_{py}$ =	250 ksi
	layer 7	$f_{py}$ =	250 ksi
	layer 8	$f_{py}$ =	250 ksi
	layer 9	$f_{py}$ =	250 ksi
	layer 10	$f_{py}$ =	250 ksi
	layer 11	$f_{py}$ =	250 ksi
	layer 12	$f_{py}$ =	250 ksi
	layer 13	$f_{py}$ =	250 ksi
	layer 14	$f_{py}$ =	250 ksi

<b>Stress Limits:</b> before transfer $\leq 0.75f_{pu}$ (initial = 207.6)	layer 1 (bottom)	$f_{pi}$ =	207.6 ksi
	layer 2	$f_{pi}$ =	207.6 ksi
	layer 3	$f_{pi}$ =	207.6 ksi
	layer 4	$f_{pi}$ =	207.6 ksi
	layer 5	$f_{pi}$ =	207.6 ksi
	layer 6	$f_{pi}$ =	207.6 ksi
	layer 7	$f_{pi}$ =	207.6 ksi
	layer 8	$f_{pi}$ =	207.6 ksi
	layer 9	$f_{pi}$ =	207.6 ksi
	layer 10	$f_{pi}$ =	207.6 ksi
	layer 11	$f_{pi}$ =	207.6 ksi
	layer 12	$f_{pi}$ =	207.6 ksi
	layer 13	$f_{pi}$ =	207.6 ksi
	layer 14	$f_{pi}$ =	207.6 ksi

at service limit state (after all losses)  $\leq 0.80f_{py}$  (initial = 199.7)

layer 1 (bottom)	$f_{pe} =$	199.7 ksi
layer 2	$f_{pe} =$	199.7 ksi
layer 3	$f_{pe} =$	199.7 ksi
layer 4	$f_{pe} =$	199.7 ksi
layer 5	$f_{pe} =$	199.7 ksi
layer 6	$f_{pe} =$	199.7 ksi
layer 7	$f_{pe} =$	199.7 ksi
layer 8	$f_{pe} =$	199.7 ksi
layer 9	$f_{pe} =$	199.7 ksi
layer 10	$f_{pe} =$	199.7 ksi
layer 11	$f_{pe} =$	199.7 ksi
layer 12	$f_{pe} =$	199.7 ksi
layer 13	$f_{pe} =$	199.7 ksi
layer 14	$f_{pe} =$	199.7 ksi

Modulus of Elasticity

initial = 25982 ksi

layer 1 (bottom)	E =	25982.0 ksi
layer 2	E =	25982.0 ksi
layer 3	E =	25982.0 ksi
layer 4	E =	25982.0 ksi
layer 5	E =	25982.0 ksi
layer 6	E =	25982.0 ksi
layer 7	E =	25982.0 ksi
layer 8	E =	25982.0 ksi
layer 9	E =	25982.0 ksi
layer 10	E =	25982.0 ksi
layer 11	E =	25982.0 ksi
layer 12	E =	25982.0 ksi
layer 13	E =	25982.0 ksi
layer 14	E =	25982.0 ksi

### MILD STEEL REINFORCING BARS

Yield Strength

Layer 1 (Bottom)	$f_y =$	60.0 ksi	68.00 °F
Layer 2 (Top)	$f_y =$	37.8 ksi	1508.00 °F

Modulus of Elasticity

E =	29000.0 ksi
-----	-------------

Layer 1 (Bottom)

Area of steel at midspan (effective flange)	$A_{sm} =$	2.79 in <sup>2</sup>
Area of steel at endspan (effective flange)	$A_{se} =$	2.48 in <sup>2</sup>
Area of temperature and shrinkage steel (12" width)	$A_s =$	0.31 in <sup>2</sup>

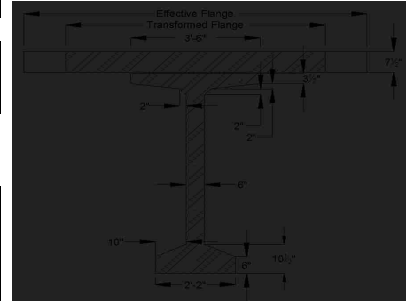
Layer 2 (Top)

Area of steel at midspan (effective flange)	$A_{sm} =$	12.6 in <sup>2</sup>
Area of steel at endspan (effective flange)	$A_{se} =$	12.4 in <sup>2</sup>
Area of temperature and shrinkage steel (12" width)	$A_s =$	0.2 in <sup>2</sup>

### Cross-sectional Properties

#### NON-COMPOSITE BEAM

Area of cross-section of beam	A =	767.0 in <sup>2</sup>
Overall depth of beam	H =	72.0 in
Moment of Inertia	I =	539,947 in <sup>4</sup>
Distance from centroid to extreme bottom fiber	$y_b =$	36.6 in
Distance from centroid to extreme top fiber	$y_t =$	35.4 in
Section modulus for the extreme bottom fiber	$S_b =$	14915.0 in <sup>3</sup>
Section modulus for the extreme top fiber	$S_t =$	15421.0 in <sup>3</sup>
Weight	$W_1 =$	799.0 plf
Modulus of Elasticity = $33000 \cdot (W_c^{1.5}) \cdot (\sqrt{f_c})$		
cast-in-place concrete deck	$E_{cs} =$	3293 ksi
precast beam at release	$E_{ci} =$	4496 ksi
precast beam at service loads	$E_c =$	5072 ksi



### COMPOSITE BEAM AT MIDSPAN

Effective Flange Width	$b_f =$	111.0 in	*min of three criteria
Modular Ratio = $E_{cf}/E_c$	$n =$	0.6492	
Transformed flange width	$=$	72.1 in	
Transformed flange area	$=$	540.4 in <sup>2</sup>	
Transformed haunch width	$=$	27.3 in	
Transformed haunch area	$=$	13.6 in <sup>2</sup>	
Deck-distance to top fiber	$y_t =$	4.82 in	

	Transformed Area	$y_b$	$Ay_b$	$A(y_{bc}-y_b)^2$	$I$	$I + A(y_{bc}-y_b)^2$
Beam	767.0 in <sup>2</sup>	36.60 in	28,072.2 in <sup>3</sup>	200,066 in <sup>4</sup>	539,947 in <sup>4</sup>	740,013 in <sup>4</sup>
Haunch	13.6 in <sup>2</sup>	72.25 in	985.0 in <sup>3</sup>	5,183 in <sup>4</sup>	0.33 in <sup>4</sup>	5,184 in <sup>4</sup>
Deck	540.4 in <sup>2</sup>	75.18 in	40,630.2 in <sup>3</sup>	271,882 in <sup>4</sup>	1,449 in <sup>4</sup>	273,331 in <sup>4</sup>
Total	1321.1 in <sup>2</sup>		69,687.3 in <sup>3</sup>			1,018,528 in <sup>4</sup>

Total area of Composite Section	$A_c =$	1321 in <sup>2</sup>
Overall Depth of the Composite Section	$h_c =$	80 in
Moment of Inertia	$I_c =$	1,018,528 in <sup>4</sup>
Distance from centroid to extreme <u>bottom</u> fiber of beam	$y_{bc} =$	52.75 in
Distance from centroid to extreme <u>top</u> fiber of beam	$y_{tc} =$	19.25 in
Distance from centroid to extreme <u>top</u> fiber of slab	$y_{ts} =$	27.25 in
Section modulus for the extreme <u>bottom</u> fiber of beam	$S_{bc} =$	19,308.4 in <sup>3</sup>
Section modulus for the extreme <u>top</u> fiber of beam	$S_{tc} =$	52,912.3 in <sup>3</sup>
Section modulus for the extreme <u>top</u> fiber slab	$S_{ts} =$	57,577.7 in <sup>3</sup>

### COMPOSITE BEAM AT ENDSPAN

Effective Flange Width	$b_f =$	106.6 in	*min of three criteria
Modular Ratio = $E_{cf}/E_c$	$n =$	0.6492	
Transformed flange width	$=$	69.2 in	
Transformed flange area	$=$	519.0 in <sup>2</sup>	
Transformed haunch width	$=$	27.3 in	
Transformed haunch area	$=$	13.6 in <sup>2</sup>	
Deck-distance to top fiber	$y_{td} =$	5.00 in	

	Transformed Area	$y_t$	$Ay_t$	$A(y_{tc}-y_t)^2$	$I$	$I + A(y_{tc}-y_t)^2$
Beam	767.0 in <sup>2</sup>	36.60 in	28,072.2 in <sup>3</sup>	245,903 in <sup>4</sup>	539,947 in <sup>4</sup>	785,850 in <sup>4</sup>
Haunch	13.6 in <sup>2</sup>	72.25 in	985.0 in <sup>3</sup>	4,371 in <sup>4</sup>	0.28 in <sup>4</sup>	4,371 in <sup>4</sup>
Deck	519.0 in <sup>2</sup>	77.50 in	40,221.1 in <sup>3</sup>	166,398 in <sup>4</sup>	1,200 in <sup>4</sup>	167,598 in <sup>4</sup>
Total	1299.6 in <sup>2</sup>		69,278.3 in <sup>3</sup>			957,819 in <sup>4</sup>

Total area of Composite Section	$A_c =$	1300 in <sup>2</sup>
Overall Depth of the Composite Section	$h_c =$	80 in
Moment of Inertia	$I_c =$	957,819 in <sup>4</sup>
Distance from centroid to extreme <u>bottom</u> fiber of beam	$y_{bc} =$	53.31 in
Distance from centroid to extreme <u>top</u> fiber of beam	$y_{tc} =$	18.69 in
Distance from centroid to extreme <u>top</u> fiber of slab	$y_{ts} =$	26.69 in
Section modulus for the extreme <u>bottom</u> fiber of beam	$S_{bc} =$	17,968.5 in <sup>3</sup>
Section modulus for the extreme <u>top</u> fiber of beam	$S_{tc} =$	51,235.1 in <sup>3</sup>
Section modulus for the extreme <u>top</u> fiber slab	$S_{ts} =$	35,880.6 in <sup>3</sup>

### Shear Forces and Bending Moments

#### DEAD LOADS

Beam self-weight	$W_{beam} =$	0.799 k/f
8 in. deck weight	$W_{deck} =$	1.200 k/f
1/2 in. haunch weight	$W_{haunch} =$	0.022 k/f

#### LRFD Specifications: Art. 4.6.2.2.1

Width of Deck Constant		OK
Number of beams is not less than four $N_b =$	4	OK
Roadway part of the overhang, $d_o \leq 3.0$ ft, $d_o =$	1.5	OK
Curvature in plans is less than $4^\circ =$	0	OK
Cross-section of the bridge is consistent with one of the cross sections given by LRFD specs		OK

Barrier and wearing surface loads are equally distributed among the 4 beams

Barrier Wt	$W_t =$	0.150 k/f
Dead load of future wearing surface	$DW =$	0.263 k/f

LIVE LOADS		
Fire truck live load front load (Point A)	$P_{live} =$	48.0 kips
Fire truck live load back load (Point B)	$P_{live} =$	22.0 kips
distance between two loads		19.2 ft
distance from nearest edge to point A	$x_a =$	59.0 ft
distance from nearest edge to point B	$x_b =$	39.8 ft
LRFD Specifications: Art. 4.6.2.2.1		
Width of Deck Constant		OK
Number of beams is not less than four $N_b =$	4	OK
Beams are parallel and approximately of the same stiffness		OK
Roadway part of the overhang, $d_o \leq 3.0$ ft, $d_o =$	1.5	OK
Curvature in plans is less than $4^\circ =$	0	OK

Barrier and wearing surface loads are equally distributed among the 4 beams

Bridge Type-- "k" (LRFD Table 4.6.2.2.1-1)

Number of design lanes = w/12	=	3 lanes
-------------------------------	---	---------

**Distribution Factor for Bending Moment:**

Beams spacing	$S =$	12.0 ft
Depth of concrete slab	$t_s =$	7.5 in
Beam Span	$L =$	120.0 ft
Number of Beams	$N_b =$	4
Modular ratio between beam & deck materials	$n =$	1.5404
Longitudinal stiffness parameter	$K_y =$	2,689,204.22 in <sup>4</sup>

at center span:

$$DFM = 0.75 + \left(\frac{S}{9.5}\right)^{0.6} * \left(\frac{S}{L}\right)^{0.2} * \left(\frac{K_y}{12 * L * t_s^3}\right)^{0.1}$$

DFM =	0.917 lanes/beam
-------	------------------

0.905 Controls

one design lane loaded:

$$DFM = 0.75 + \left(\frac{S}{14}\right)^{0.4} * \left(\frac{S}{L}\right)^{0.2} * \left(\frac{K_y}{12 * L * t_s^3}\right)^{0.1}$$

DFM =	0.622 lanes/beam
-------	------------------

**Distribution Factor for Shear Force**

both end spans and center span:

$$DFV = 0.2 + \left(\frac{S}{12}\right) - \left(\frac{S}{35}\right)^2$$

DFV =	1.082 lanes/beam
-------	------------------

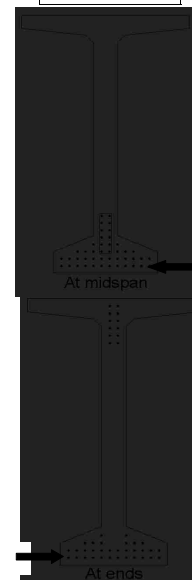
1.082 Controls

one design lane loaded:

$$DFV = 0.36 + \left(\frac{S}{25}\right)$$

DFV =	0.840 lanes/beam
-------	------------------

	At Midspan		At Ends	
from bottom	No. of	Distance from Bottom	No. of	Distance from Bottom
layer 1	12	2	12	2
layer 2	12	4	12	4
layer 3	8	6	6	6
layer 4	4	8	2	8
layer 5	2	10	-	-
layer 6	2	12	-	-
layer 7	2	14	-	-
layer 8	2	16	-	-
layer 9	-	-	2	60
layer 10	-	-	2	62
layer 11	-	-	2	64
layer 12	-	-	2	66
layer 13	-	-	2	68
layer 14	-	-	2	70
<b>Harped Strand Group (included in above totals)</b>				
layer 3	2	6		
layer 4	2	8		
layer 5	2	10		
layer 6	2	12		
layer 7	2	14		
layer 8	2	16		





distance from the center of gravity of strands to the bottom fiber of the beam = 7% of the beam depth  
strand eccentricity at midspan =  $(y_t - y_{bs})$

$y_{bs} =$	5.82 in
$e_c =$	30.78 in

### Prestress Losses

#### ELASTIC SHORTENING

assumed loss	=	9.00%
Force per strand at transfer		
layer 1	=	28.9 kips
layer 2	=	28.9 kips
layer 3	=	28.9 kips
layer 4	=	28.9 kips
layer 5	=	28.9 kips
layer 6	=	28.9 kips
layer 7	=	28.9 kips
layer 8	=	28.9 kips
layer 9	=	28.9 kips
layer 10	=	28.9 kips
layer 11	=	28.9 kips
layer 12	=	28.9 kips
layer 13	=	28.9 kips
layer 14	=	28.9 kips

Total prestressing force at release	$P_i =$	at midspan 1271.6 kips	at endspan 1271.6 kips
	Sum of concrete stresses at the center of gravity of prestressing tendons due to prestressing force at transfer and the self-weight of the member at sections of maximum moment $f_{csp} =$	2.938 ksi	2.938 ksi
Loss due to shortening		at midspan	at endspan
	layer 1	$\Delta f_{PES} =$ 17.0 ksi	17.0 ksi
	layer 2	$\Delta f_{PES} =$ 17.0 ksi	17.0 ksi
	layer 3	$\Delta f_{PES} =$ 17.0 ksi	17.0 ksi
	layer 4	$\Delta f_{PES} =$ 17.0 ksi	17.0 ksi
	layer 5	$\Delta f_{PES} =$ 17.0 ksi	
	layer 6	$\Delta f_{PES} =$ 17.0 ksi	
	layer 7	$\Delta f_{PES} =$ 17.0 ksi	
	layer 8	$\Delta f_{PES} =$ 17.0 ksi	
	layer 9	$\Delta f_{PES} =$	17.0 ksi
	layer 10	$\Delta f_{PES} =$	17.0 ksi
	layer 11	$\Delta f_{PES} =$	17.0 ksi
	layer 12	$\Delta f_{PES} =$	17.0 ksi
	layer 13	$\Delta f_{PES} =$	17.0 ksi
layer 14	$\Delta f_{PES} =$	17.0 ksi	

#### SHRINKAGE

Shrinkage = $(17 - 0.15 \cdot \text{Relative Humidity})$	$\Delta f_{PSR} =$	6.5 ksi	← assume relative humidity = 70%
--	--------------------	---------	----------------------------------

#### CREEP OF CONCRETE

Change of stresses at center of gravity of prestressing due to permanent loads except the loads acting at time of applying prestressing force, calculated at the same section as $f_{csp}$	$\Delta f_{cdp} =$	1.566 ksi	
		at midspan	at endspan
loss due to creep	$\Delta f_{PCR} =$	24.3 ksi	24.3 ksi

**RELAXATION OF PRESTRESSING STRANDS**

loss due to relaxation after transfer		at midspan	at endspan
layer 1	$\Delta f_{pR2} =$	2.1 ksi	2.1 ksi
layer 2	$\Delta f_{pR2} =$	2.1 ksi	2.1 ksi
layer 3	$\Delta f_{pR2} =$	2.1 ksi	2.1 ksi
layer 4	$\Delta f_{pR2} =$	2.1 ksi	2.1 ksi
layer 5	$\Delta f_{pR2} =$	2.1 ksi	
layer 6	$\Delta f_{pR2} =$	2.1 ksi	
layer 7	$\Delta f_{pR2} =$	2.1 ksi	
layer 8	$\Delta f_{pR2} =$	2.1 ksi	
layer 9	$\Delta f_{pR2} =$		2.1 ksi
layer 10	$\Delta f_{pR2} =$		2.1 ksi
layer 11	$\Delta f_{pR2} =$		2.1 ksi
layer 12	$\Delta f_{pR2} =$		2.1 ksi
layer 13	$\Delta f_{pR2} =$		2.1 ksi
layer 14	$\Delta f_{pR2} =$		2.1 ksi

**TOTAL LOSSES AT TRANSFER**

total loss  $\Delta f_{pES} = \Delta f_{pi}$

stress in tendons after transfer  $f_{pt} = f_{pi} - \Delta f_{pi}$

		at midspan	at endspan
layer 1	$f_{pt} =$	190.6 ksi	190.6 ksi
layer 2	$f_{pt} =$	190.6 ksi	190.6 ksi
layer 3	$f_{pt} =$	190.6 ksi	190.6 ksi
layer 4	$f_{pt} =$	190.6 ksi	190.6 ksi
layer 5	$f_{pt} =$	190.6 ksi	
layer 6	$f_{pt} =$	190.6 ksi	
layer 7	$f_{pt} =$	190.6 ksi	
layer 8	$f_{pt} =$	190.6 ksi	
layer 9	$f_{pt} =$		190.6 ksi
layer 10	$f_{pt} =$		190.6 ksi
layer 11	$f_{pt} =$		190.6 ksi
layer 12	$f_{pt} =$		190.6 ksi
layer 13	$f_{pt} =$		190.6 ksi
layer 14	$f_{pt} =$		190.6 ksi

force per strand =  $f_{pt} \times \text{strand area}$

		at midspan	at endspan
layer 1	=	29.2 kips	29.2 kips
layer 2	=	29.2 kips	29.2 kips
layer 3	=	29.2 kips	29.2 kips
layer 4	=	29.2 kips	29.2 kips
layer 5	=	29.2 kips	
layer 6	=	29.2 kips	
layer 7	=	29.2 kips	
layer 8	=	29.2 kips	
layer 9	=		29.2 kips
layer 10	=		29.2 kips
layer 11	=		29.2 kips
layer 12	=		29.2 kips
layer 13	=		29.2 kips
layer 14	=		29.2 kips
Total prestressing force after transfer	$P_1 =$	1284.8 kips	1284.8 kips

Initial loss =  $(\Delta f_{pi}) / (f_{pi})$

		at midspan	at endspan
layer 1	% =	8.2%	8.2%
layer 2	% =	8.2%	8.2%
layer 3	% =	8.2%	8.2%
layer 4	% =	8.2%	8.2%
layer 5	% =	8.2%	
layer 6	% =	8.2%	
layer 7	% =	8.2%	
layer 8	% =	8.2%	
layer 9	% =		8.2%
layer 10	% =		8.2%
layer 11	% =		8.2%
layer 12	% =		8.2%
layer 13	% =		8.2%
layer 14	% =		8.2%

OK  
OK  
OK  
OK  
OK  
OK  
OK  
OK  
OK  
OK  
OK  
OK  
OK  
OK  
OK

**TOTAL LOSSES AT SERVICE LOADS**

Total Losses		at midspan	at endspan
layer 1	$\Delta f_{pT} =$	49.9 ksi	49.9 ksi
layer 2	$\Delta f_{pT} =$	49.9 ksi	49.9 ksi
layer 3	$\Delta f_{pT} =$	49.9 ksi	49.9 ksi
layer 4	$\Delta f_{pT} =$	49.9 ksi	49.9 ksi
layer 5	$\Delta f_{pT} =$	49.9 ksi	
layer 6	$\Delta f_{pT} =$	49.9 ksi	
layer 7	$\Delta f_{pT} =$	49.9 ksi	
layer 8	$\Delta f_{pT} =$	49.9 ksi	
layer 9	$\Delta f_{pT} =$		49.9 ksi
layer 10	$\Delta f_{pT} =$		49.9 ksi
layer 11	$\Delta f_{pT} =$		49.9 ksi
layer 12	$\Delta f_{pT} =$		49.9 ksi
layer 13	$\Delta f_{pT} =$		49.9 ksi
layer 14	$\Delta f_{pT} =$		49.9 ksi

Stress in tendon after all losses =  $f_{pe} - \Delta f_{pT}$

		at midspan	at endspan
layer 1	$f_{pe} =$	157.7 ksi	157.7 ksi
layer 2	$f_{pe} =$	157.7 ksi	157.7 ksi
layer 3	$f_{pe} =$	157.7 ksi	157.7 ksi
layer 4	$f_{pe} =$	157.7 ksi	157.7 ksi
layer 5	$f_{pe} =$	157.7 ksi	
layer 6	$f_{pe} =$	157.7 ksi	
layer 7	$f_{pe} =$	157.7 ksi	
layer 8	$f_{pe} =$	157.7 ksi	
layer 9	$f_{pe} =$		157.7 ksi
layer 10	$f_{pe} =$		157.7 ksi
layer 11	$f_{pe} =$		157.7 ksi
layer 12	$f_{pe} =$		157.7 ksi
layer 13	$f_{pe} =$		157.7 ksi
layer 14	$f_{pe} =$		157.7 ksi

check prestressing stress limit at service limit state:  $f_{pe} \leq 0.8 \cdot f_{py}$

layer 1	=	199.7 ksi
layer 2	=	199.7 ksi
layer 3	=	199.7 ksi
layer 4	=	199.7 ksi
layer 5	=	199.7 ksi
layer 6	=	199.7 ksi
layer 7	=	199.7 ksi
layer 8	=	199.7 ksi
layer 9	=	199.7 ksi
layer 10	=	199.7 ksi
layer 11	=	199.7 ksi
layer 12	=	199.7 ksi
layer 13	=	199.7 ksi
layer 14	=	199.7 ksi

OK  
OK  
OK  
OK  
OK  
OK  
OK  
OK  
OK  
OK  
OK  
OK  
OK  
OK

force per strand =  $f_{pe} \cdot \text{strand area}$

		at midspan	at endspan
layer 1	=	24.1 kips	24.1 kips
layer 2	=	24.1 kips	24.1 kips
layer 3	=	24.1 kips	24.1 kips
layer 4	=	24.1 kips	24.1 kips
layer 5	=	24.1 kips	
layer 6	=	24.1 kips	
layer 7	=	24.1 kips	
layer 8	=	24.1 kips	
layer 9	=		24.1 kips
layer 10	=		24.1 kips
layer 11	=		24.1 kips
layer 12	=		24.1 kips
layer 13	=		24.1 kips
layer 14	=		24.1 kips

Total prestressing force after all losses		at midspan	at endspan
$P_{pe} =$		1061.7 kips	1061.7 kips

Final losses, % =  $(\Delta f_{pr})/f_{pi}$

layer 1	% =	24.0%	24.0%
layer 2	% =	24.0%	24.0%
layer 3	% =	24.0%	24.0%
layer 4	% =	24.0%	24.0%
layer 5	% =	24.0%	
layer 6	% =	24.0%	
layer 7	% =	24.0%	
layer 8	% =	24.0%	
layer 9	% =		24.0%
layer 10	% =		24.0%
layer 11	% =		24.0%
layer 12	% =		24.0%
layer 13	% =		24.0%
layer 14	% =		24.0%
Average final losses, %	% =	24.0%	24.0%

**Stresses at Transfer**

**STRESS LIMITS FOR CONCRETE**

Compression = $0.6f_{ci}$	$f_{ci}$ =	3.300 ksi
Tension		
without bonded reinforcement = $-0.0948 \sqrt{f_{ci}} \leq -0.2$	=	-0.200 ksi
with bonded auxiliary reinforcement = $-0.22 \sqrt{f_{ci}}$	=	-0.016 ksi

**STRESSES AT TRANSFER LENGTH SECTION**

Transfer Length = $60 \times$ (strand diameter)	=	2.5 ft	} Calcs for eccentricity (see 9.6.7.2)
Bending moment at transfer length	$M_g$ =	116.4 ft-kips	
center of 12 strands to top fiber of beam at the end	=	7.00 in	
center of 12 strands to bottom fiber of beam at the harp point	=	11.00 in	
center of 12 strands and top fiber of beam at transfer length	=	10.78 in	
center of gravity of 32 strands and bottom fiber of beam	=	3.88 in	
center of gravity of all strands and the bottom fiber of beam at transfer length	=	19.51 in	
center of gravity of all strands and the bottom fiber of beam at the end	=	20.55 in	
Eccentricity of the strand group at transfer length:	$e_n$ =	17.09 in	
Eccentricity at end of beam:	$e$ =	16.05 in	

$$f_t = \frac{P_i}{A} - \frac{P_i e}{S_t} + \frac{M_g}{S_t} \qquad f_b = \frac{P_i}{A} + \frac{P_i e}{S_b} - \frac{M_g}{S_b}$$

		<b>at midspan</b>	<b>at endspan</b>	
Top stress at top fiber of beam	$f_t$ =	0.342 ksi	0.342 ksi	OK
Bottom stress at bottom fiber of the beam	$f_b$ =	3.021 ksi	3.021 ksi	OK

**STRESSES AT HARP POINT**

Bending moment due to beam weight at 0.3L	$M_g$ =	1188.0 ft-kips		
Top stress at top fiber of beam	$f_t$ =	0.035 ksi	0.035 ksi	OK
Bottom stress at bottom fiber of the beam	$f_b$ =	3.300 ksi	3.300 ksi	OK

**STRESSES AT MIDSPAN**

Bending moment due to beam weight at 0.5L	$M_g$ =	1414.3 ft-kips		
Top stress at top fiber of beam	$f_t$ =	0.220 ksi	0.211 ksi	OK
Bottom stress at bottom fiber of the beam	$f_b$ =	3.144 ksi	3.189 ksi	OK

**HOLD-DOWN FORCES**

assume stress in strand before losses =  $0.8f_u$

layer 1	=	221.4 ksi
layer 2	=	221.4 ksi
layer 3	=	221.4 ksi
layer 4	=	221.4 ksi
layer 5	=	221.4 ksi
layer 6	=	221.4 ksi
layer 7	=	221.4 ksi
layer 8	=	221.4 ksi
layer 9	=	221.4 ksi
layer 10	=	221.4 ksi
layer 11	=	221.4 ksi
layer 12	=	221.4 ksi
layer 13	=	221.4 ksi
layer 14	=	221.4 ksi

prestress force per strand before any losses:

layer 1	=	33.9 kips
layer 2	=	33.9 kips
layer 3	=	33.9 kips
layer 4	=	33.9 kips
layer 5	=	33.9 kips
layer 6	=	33.9 kips
layer 7	=	33.9 kips
layer 8	=	33.9 kips
layer 9	=	33.9 kips
layer 10	=	33.9 kips
layer 11	=	33.9 kips
layer 12	=	33.9 kips
layer 13	=	33.9 kips
layer 14	=	33.9 kips
Harp Angle	$\psi =$	7.2 °

Hold-down force/strand

layer 1	=	4.4 kips/strand
layer 2	=	4.4 kips/strand
layer 3	=	4.4 kips/strand
layer 4	=	4.4 kips/strand
layer 5	=	4.4 kips/strand
layer 6	=	4.4 kips/strand
layer 7	=	4.4 kips/strand
layer 8	=	4.4 kips/strand
layer 9	=	4.4 kips/strand
layer 10	=	4.4 kips/strand
layer 11	=	4.4 kips/strand
layer 12	=	4.4 kips/strand
layer 13	=	4.4 kips/strand
layer 14	=	4.4 kips/strand
Total hold-down force	=	53.39 kips

### Stresses at Service Loads

#### STRESS LIMITS FOR CONCRETE

Compression:

Due to permanent loads for load combination Service I

for the precast beam	=	3.150 ksi
for deck	=	1.328 ksi

Due to permanent and transient loads for load combination Service I

for the precast beam	=	4.200 ksi
for deck	=	1.770 ksi

Tension:

Load Combination Service III

for the precast beam	=	-0.016 ksi
----------------------	---	------------

#### STRESSES AT MIDSPAN

Compression stresses at top fiber of beam	at midspan	at endspan	
$f_t = \frac{P_{pe}}{A} - \frac{P_{pe}e}{S_x} + \frac{(M_D + M_{L1})}{S_x} - \frac{(M_{D2} + M_{L2})}{S_{x2}}$			
Due to permanent loads	$f_{t1} =$	2.048 ksi	2.048 ksi
$f_{t2} = \frac{P_{pe}}{A} - \frac{P_{pe}e}{S_x} + \frac{(M_D + M_{L1})}{S_x} + \frac{(M_{D2} + M_{L2})}{S_{x2}} + \frac{(M_{L2+3})}{S_{x2}}$			
Due to permanent loads and transient loads	$f_{t2} =$	2.527 ksi	2.527 ksi
Compression stresses at top fiber of deck	at midspan	at endspan	
$f_{tc} = \frac{(M_{D2} + M_{L2})}{S_{x2}}$			
Due to permanent loads	$f_{tc} =$	0.042 ksi	0.042 ksi
$f_{tc} = \frac{(M_{D2} + M_{L2} + M_{L2+3})}{S_{x2}}$			
Due to permanent loads and transient loads	$f_{tc} =$	0.483 ksi	0.483 ksi
Tension stresses at top fiber of deck	at midspan	at endspan	
$f_{t2} = \frac{P_{pe}}{A} - \frac{P_{pe}e}{S_x} - \frac{(M_D + M_{L1})}{S_x} - \frac{(M_{D2} + M_{L2} + C.8 * M_{L2+3})}{S_{x2}}$			
Load Combination Service III	$f_{t2} =$	-0.431 ksi	-0.431 ksi

OK

OK

OK

OK

OK

**Strength Limit State**

**POSITIVE MOMENT SECTION**

$M_u = 1.25DC+1.5DW+1.75(LL+IM)$	$M_u =$	8381.5 ft-kips
effective length factor for compression members		
layer 1	k =	0.28
layer 2	k =	0.28
layer 3	k =	0.28
layer 4	k =	0.28
layer 5	k =	0.28
layer 6	k =	0.28
layer 7	k =	0.28
layer 8	k =	0.28
layer 9	k =	0.28
layer 10	k =	0.28
layer 11	k =	0.28
layer 12	k =	0.28
layer 13	k =	0.28
layer 14	k =	0.28
	c =	7.7 ft-kips

average stress in prestressing steel

layer 1	$f_{ps} =$	268.9 ksi
layer 2	$f_{ps} =$	268.9 ksi
layer 3	$f_{ps} =$	268.9 ksi
layer 4	$f_{ps} =$	268.9 ksi
layer 5	$f_{ps} =$	268.9 ksi
layer 6	$f_{ps} =$	268.9 ksi
layer 7	$f_{ps} =$	268.9 ksi
layer 8	$f_{ps} =$	268.9 ksi
layer 9	$f_{ps} =$	268.9 ksi
layer 10	$f_{ps} =$	268.9 ksi
layer 11	$f_{ps} =$	268.9 ksi
layer 12	$f_{ps} =$	268.9 ksi
layer 13	$f_{ps} =$	268.9 ksi
layer 14	$f_{ps} =$	268.9 ksi

nominal flexure resistance

	a =	6.52 in
$M_r = \Phi M_n, \Phi = 1.00$	$\Phi M_n =$	10697.9 ft-kips

OK

**NEGATIVE MOMENT SECTION**

$M_u = 1.25DC+1.5DW+1.75(LL+IM)$	$M_u =$	-4837.2 ft-kips
	a =	0.17 in
	$\Phi M_n =$	3527.5 ft-kips

NOT OK

**Shear Design**

**CRITICAL SECTION AT 0.59**

$V_u = 1.25DC+1.5DW+1.75(LL+IM)$	$V_u =$	405.0 kips
$M_u = 1.25DC+1.5DW+1.75(LL+IM)$	$M_u =$	-2684.4 ft-kips
or		
$V_u = 1.25DC+1.5DW+1.75(LL+IM)$	$V_u =$	364.8 kips
$M_u = 1.25DC+1.5DW+1.75(LL+IM)$	$M_u =$	-2877.0 ft-kips
max shear	$V_u =$	405.0 kips
max moment	$M_u =$	2877.0 ft-kips
Shear depth	$d_v =$	73.19 in
Applied factored normal force at the section	$N_u =$	0
Angle of diagonal compressive stresses	$\theta =$	36.00 °

### STRAIN IN FLEXURAL TENSION REINFORCEMENT

$$\epsilon_x = \frac{\frac{M}{d_v} + 0.5N_u + 0.5V_u \cot \theta - A_{ps} f_{ps}}{E_s A_s + E_p A_{ps}} \leq 0.002$$

		at midspan	at endspan
resultant compressive stress at centroid	$f_{pc} =$	1.035 ksi	1.035 ksi
effective stress in prestressing strand after all losses			
layer 1	$f_{po} =$	163.0 ksi	163.0 ksi
layer 2	$f_{po} =$	163.0 ksi	163.0 ksi
layer 3	$f_{po} =$	163.0 ksi	163.0 ksi
layer 4	$f_{po} =$	163.0 ksi	163.0 ksi
layer 5	$f_{po} =$	163.0 ksi	
layer 6	$f_{po} =$	163.0 ksi	
layer 7	$f_{po} =$	163.0 ksi	
layer 8	$f_{po} =$	163.0 ksi	
layer 9	$f_{po} =$		163.0 ksi
layer 10	$f_{po} =$		163.0 ksi
layer 11	$f_{po} =$		163.0 ksi
layer 12	$f_{po} =$		163.0 ksi
layer 13	$f_{po} =$		163.0 ksi
layer 14	$f_{po} =$		163.0 ksi

		at midspan	at endspan
strain in flexural tension			
layer 1	$\epsilon_x =$	0.002000	0.002000
layer 2	$\epsilon_x =$	0.002000	0.002000
layer 3	$\epsilon_x =$	0.002000	0.002000
layer 4	$\epsilon_x =$	0.002000	0.002000
layer 5	$\epsilon_x =$	0.002000	
layer 6	$\epsilon_x =$	0.002000	
layer 7	$\epsilon_x =$	0.002000	
layer 8	$\epsilon_x =$	0.002000	
layer 9	$\epsilon_x =$		0.002000
layer 10	$\epsilon_x =$		0.002000
layer 11	$\epsilon_x =$		0.002000
layer 12	$\epsilon_x =$		0.002000
layer 13	$\epsilon_x =$		0.002000
layer 14	$\epsilon_x =$		0.002000

### Deflection and Camber

		at midspan	at endspan
Deflection due to Prestressing Force at Transfer	$\Delta_p =$	3.97 in	3.97 in
Deflection due to Beam Self-Weight at Transfer	$\Delta_g =$	-1.49 in	
Deflection due to Beam Self-Weight at Erection	$\Delta_g =$	-1.44 in	
Deflection due to Haunch and Deck	$\Delta_g =$	-1.95 in	
Deflection due to total self weight	$\Delta_{sw} =$	0.59 in	
Total Deflection at transfer	$\Delta =$	2.48 in	2.48 in
Total Deflection at erection	$\Delta =$	4.49 in	4.49 in
Live load deflection limit = span/800	$=$	1.80 in	
Deflection due to live load and impact	$\Delta_L =$	-0.90 in	
Deflection due to fire truck	$\Delta_L =$	-0.8144 in	
Total Deflection after fire with fire truck	$\Delta =$	3.7408 in	

OK

OK

**Parametric Design: I-5 Overpass Case Study**  
**Beam Design: 3/8" Strand**  
**Fire Exposure Status: Undamaged**

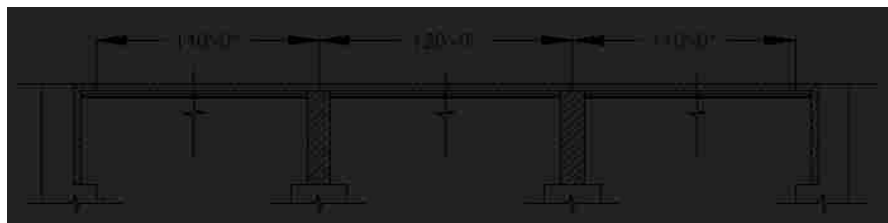
(PCI Bridge Design Manual Section 9.6)



**Material Properties**

CAST-IN-PLACE SLAB			
Actual Thickness	$t_{as} =$		8.0 in
Wearing Surface	$=$		0.5 in
Structural thickness = Actual - Wearing Surface	$t_s =$		7.5 in
Compressive Strength	$f'_c =$		4.00 ksi
Unit Weight	$w_c =$		150.0 pcf
Stress factor of compression block	$\beta_1 =$		0.85

BEAMS: AASHTO-PCI, BT-72 BULB-TEE			
Strength at release	$f_{ci} =$		5.5 ksi
Strength at 28 days	$f'_c =$		7 ksi
Unit Weight	$w_c =$		150.0 pcf
Overall Beam Length:			
@ end spans	$L =$		110 ft
@ center span	$L =$		119 ft
Design Spans:			
Non-composite beam @ end spans	$L =$		109 ft
Non-composite beam @ center span	$L =$		118 ft
Composite beam @ end spans	$L =$		110 ft
Composite beam @ center span	$L =$		120 ft
Beam Spacing	$S =$		12 ft





**PRESTRESSING STRANDS**

Diameter of single strand	d =	0.4 in
Area of single strand	A =	0.085 in <sup>2</sup>
Temperature of Layer		
	layer 1 (bottom)	T = 68.00 °F
	layer 2	T = 68.00 °F
	layer 3	T = 68.00 °F
	layer 4	T = 68.00 °F
	layer 5	T = 68.00 °F
	layer 6	T = 68.00 °F
	layer 7	T = 68.00 °F
	layer 8	T = 68.00 °F
	layer 9	T = 68.00 °F
	layer 10	T = 68.00 °F
	layer 11	T = 68.00 °F
	layer 12	T = 68.00 °F
	layer 13	T = 68.00 °F
	layer 14	T = 68.00 °F
Ultimate Strength		
initial = 284 ksi		
	layer 1 (bottom)	f <sub>pu</sub> = 284 ksi
	layer 2	f <sub>pu</sub> = 284 ksi
	layer 3	f <sub>pu</sub> = 284 ksi
	layer 4	f <sub>pu</sub> = 284 ksi
	layer 5	f <sub>pu</sub> = 284 ksi
	layer 6	f <sub>pu</sub> = 284 ksi
	layer 7	f <sub>pu</sub> = 284 ksi
	layer 8	f <sub>pu</sub> = 284 ksi
	layer 9	f <sub>pu</sub> = 284 ksi
	layer 10	f <sub>pu</sub> = 284 ksi
	layer 11	f <sub>pu</sub> = 284 ksi
	layer 12	f <sub>pu</sub> = 284 ksi
	layer 13	f <sub>pu</sub> = 284 ksi
	layer 14	f <sub>pu</sub> = 284 ksi
Yield Strength		
initial = 257 ksi		
	layer 1 (bottom)	f <sub>py</sub> = 257 ksi
	layer 2	f <sub>py</sub> = 257 ksi
	layer 3	f <sub>py</sub> = 257 ksi
	layer 4	f <sub>py</sub> = 257 ksi
	layer 5	f <sub>py</sub> = 257 ksi
	layer 6	f <sub>py</sub> = 257 ksi
	layer 7	f <sub>py</sub> = 257 ksi
	layer 8	f <sub>py</sub> = 257 ksi
	layer 9	f <sub>py</sub> = 257 ksi
	layer 10	f <sub>py</sub> = 257 ksi
	layer 11	f <sub>py</sub> = 257 ksi
	layer 12	f <sub>py</sub> = 257 ksi
	layer 13	f <sub>py</sub> = 257 ksi
	layer 14	f <sub>py</sub> = 257 ksi
<b>Stress Limits:</b>		
before transfer ≤ 0.75f <sub>pu</sub> (initial = 213.2)		
	layer 1 (bottom)	f <sub>pi</sub> = 213.2 ksi
	layer 2	f <sub>pi</sub> = 213.2 ksi
	layer 3	f <sub>pi</sub> = 213.2 ksi
	layer 4	f <sub>pi</sub> = 213.2 ksi
	layer 5	f <sub>pi</sub> = 213.2 ksi
	layer 6	f <sub>pi</sub> = 213.2 ksi
	layer 7	f <sub>pi</sub> = 213.2 ksi
	layer 8	f <sub>pi</sub> = 213.2 ksi
	layer 9	f <sub>pi</sub> = 213.2 ksi
	layer 10	f <sub>pi</sub> = 213.2 ksi
	layer 11	f <sub>pi</sub> = 213.2 ksi
	layer 12	f <sub>pi</sub> = 213.2 ksi
	layer 13	f <sub>pi</sub> = 213.2 ksi
	layer 14	f <sub>pi</sub> = 213.2 ksi

at service limit state (after all losses)  $\leq 0.80f_{py}$  (initial = 205.4)

layer 1 (bottom)	$f_{pe} =$	205.4 ksi
layer 2	$f_{pe} =$	205.4 ksi
layer 3	$f_{pe} =$	205.4 ksi
layer 4	$f_{pe} =$	205.4 ksi
layer 5	$f_{pe} =$	205.4 ksi
layer 6	$f_{pe} =$	205.4 ksi
layer 7	$f_{pe} =$	205.4 ksi
layer 8	$f_{pe} =$	205.4 ksi
layer 9	$f_{pe} =$	205.4 ksi
layer 10	$f_{pe} =$	205.4 ksi
layer 11	$f_{pe} =$	205.4 ksi
layer 12	$f_{pe} =$	205.4 ksi
layer 13	$f_{pe} =$	205.4 ksi
layer 14	$f_{pe} =$	205.4 ksi

Modulus of Elasticity

initial = 25898 ksi

layer 1 (bottom)	E =	25898.0 ksi
layer 2	E =	25898.0 ksi
layer 3	E =	25898.0 ksi
layer 4	E =	25898.0 ksi
layer 5	E =	25898.0 ksi
layer 6	E =	25898.0 ksi
layer 7	E =	25898.0 ksi
layer 8	E =	25898.0 ksi
layer 9	E =	25898.0 ksi
layer 10	E =	25898.0 ksi
layer 11	E =	25898.0 ksi
layer 12	E =	25898.0 ksi
layer 13	E =	25898.0 ksi
layer 14	E =	25898.0 ksi

### MILD STEEL REINFORCING BARS

Yield Strength

Layer 1 (Bottom)	$f_y =$	60.0 ksi	68.00 °F
Layer 2 (Top)	$f_y =$	60.0 ksi	68.00 °F

Modulus of Elasticity

Layer 1 (Bottom)	E =	29000.0 ksi
Layer 2 (Top)	E =	29000.0 ksi

Layer 1 (Bottom)

Area of steel at midspan (effective flange)	$A_{sm} =$	2.79 in <sup>2</sup>
Area of steel at endspan (effective flange)	$A_{se} =$	2.48 in <sup>2</sup>
Area of temperature and shrinkage steel (12" width)	$A_s =$	0.31 in <sup>2</sup>

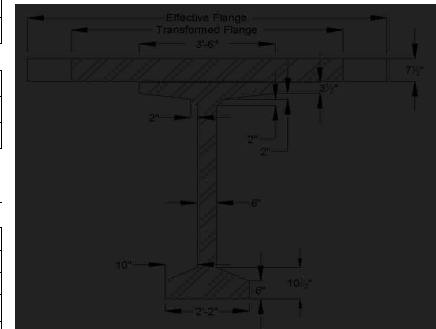
Layer 2 (Top)

Area of steel at midspan (effective flange)	$A_{sm} =$	12.6 in <sup>2</sup>
Area of steel at endspan (effective flange)	$A_{se} =$	12.4 in <sup>2</sup>
Area of temperature and shrinkage steel (12" width)	$A_s =$	0.2 in <sup>2</sup>

### Cross-sectional Properties

#### NON-COMPOSITE BEAM

Area of cross-section of beam	A =	767.0 in <sup>2</sup>
Overall depth of beam	H =	72.0 in
Moment of Inertia	I =	539,947 in <sup>4</sup>
Distance from centroid to extreme <b>bottom</b> fiber	$y_b =$	36.6 in
Distance from centroid to extreme <b>top</b> fiber	$y_t =$	35.4 in
Section modulus for the extreme <b>bottom</b> fiber	$S_b =$	14915.0 in <sup>3</sup>
Section modulus for the extreme <b>top</b> fiber	$S_t =$	15421.0 in <sup>3</sup>
Weight	$W_t =$	799.0 plf
Modulus of Elasticity = $33000 \cdot (W_c^{1.5}) \cdot (\sqrt{f_c})$		
cast-in-place concrete deck	$E_{cs} =$	3834 ksi
precast beam at release	$E_{ci} =$	4496 ksi
precast beam at service loads	$E_c =$	5072 ksi



### COMPOSITE BEAM AT MIDSPAN

Effective Flange Width	$b_f =$	111.0 in	*min of three criteria
Modular Ratio = $E_{cs}/E_c$	$n =$	0.7559	
Transformed flange width	$=$	83.9 in	
Transformed flange area	$=$	629.3 in <sup>2</sup>	
Transformed haunch width	$=$	31.7 in	
Transformed haunch area	$=$	15.9 in <sup>2</sup>	
Deck-distance to top fiber	$y_t =$	3.75 in	

	Transformed Area	$y_b$	$Ay_b$	$A(y_{bc}-y_b)^2$	I	$I + A(y_{bc}-y_b)^2$
Beam	767.0 in <sup>2</sup>	36.60 in	28,072.2 in <sup>3</sup>	250,443 in <sup>4</sup>	539,947 in <sup>4</sup>	790,390 in <sup>4</sup>
Haunch	15.9 in <sup>2</sup>	72.25 in	1,146.9 in <sup>3</sup>	4,906 in <sup>4</sup>	0.33 in <sup>4</sup>	4,906 in <sup>4</sup>
Deck	629.3 in <sup>2</sup>	76.25 in	47,985.0 in <sup>3</sup>	293,069 in <sup>4</sup>	2,950 in <sup>4</sup>	296,019 in <sup>4</sup>
Total	1412.2 in <sup>2</sup>		77,204.1 in <sup>3</sup>			1,091,316 in <sup>4</sup>

Total area of Composite Section	$A_c =$	1412 in <sup>2</sup>
Overall Depth of the Composite Section	$h_c =$	80 in
Moment of Inertia	$I_c =$	1,091,316 in <sup>4</sup>
Distance from centroid to extreme <u>bottom</u> fiber of beam	$y_{bc} =$	54.67 in
Distance from centroid to extreme <u>top</u> fiber of beam	$y_{tg} =$	17.33 in
Distance from centroid to extreme <u>top</u> fiber of slab	$y_{tc} =$	25.33 in
Section modulus for the extreme <u>bottom</u> fiber of beam	$S_{bc} =$	19,961.9 in <sup>3</sup>
Section modulus for the extreme <u>top</u> fiber of beam	$S_{tg} =$	62,972.4 in <sup>3</sup>
Section modulus for the extreme <u>top</u> fiber slab	$S_{tc} =$	56,994.5 in <sup>3</sup>

### COMPOSITE BEAM AT ENDSpan

Effective Flange Width	$b_f =$	106.6 in	*min of three criteria
Modular Ratio = $E_{cs}/E_c$	$n =$	0.7559	
Transformed flange width	$=$	80.6 in	
Transformed flange area	$=$	604.4 in <sup>2</sup>	
Transformed haunch width	$=$	31.7 in	
Transformed haunch area	$=$	15.9 in <sup>2</sup>	
Deck-distance to top fiber	$y_{td} =$	3.75 in	

	Transformed Area	$y_t$	$Ay_t$	$A(y_{bc}-y_t)^2$	I	$I + A(y_{bc}-y_t)^2$
Beam	767.0 in <sup>2</sup>	36.60 in	28,072.2 in <sup>3</sup>	273,455 in <sup>4</sup>	539,947 in <sup>4</sup>	813,402 in <sup>4</sup>
Haunch	15.9 in <sup>2</sup>	72.25 in	1,146.9 in <sup>3</sup>	5,660 in <sup>4</sup>	0.33 in <sup>4</sup>	5,660 in <sup>4</sup>
Deck	604.4 in <sup>2</sup>	76.25 in	46,082.8 in <sup>3</sup>	215,472 in <sup>4</sup>	2,833 in <sup>4</sup>	218,305 in <sup>4</sup>
Total	1387.2 in <sup>2</sup>		75,302.0 in <sup>3</sup>			1,037,366 in <sup>4</sup>

Total area of Composite Section	$A_c =$	1387 in <sup>2</sup>
Overall Depth of the Composite Section	$h_c =$	80 in
Moment of Inertia	$I_c =$	1,037,366 in <sup>4</sup>
Distance from centroid to extreme <u>bottom</u> fiber of beam	$y_{bc} =$	54.28 in
Distance from centroid to extreme <u>top</u> fiber of beam	$y_{tg} =$	17.72 in
Distance from centroid to extreme <u>top</u> fiber of slab	$y_{tc} =$	25.72 in
Section modulus for the extreme <u>bottom</u> fiber of beam	$S_{bc} =$	19,110.7 in <sup>3</sup>
Section modulus for the extreme <u>top</u> fiber of beam	$S_{tg} =$	58,548.3 in <sup>3</sup>
Section modulus for the extreme <u>top</u> fiber slab	$S_{tc} =$	40,336.0 in <sup>3</sup>

### Shear Forces and Bending Moments

#### DEAD LOADS

Beam self-weight	$w_{beam} =$	0.799 k/f
8 in. deck weight	$w_{deck} =$	1.200 k/f
1/2 in. haunch weight	$w_{haunch} =$	0.022 k/f

LRFD Specifications: Art. 4.6.2.2.1

Width of Deck Constant	4	OK
Number of beams is not less than four $N_b =$	4	OK
Roadway part of the overhang, $d_b \leq 3.0$ ft, $d_b =$	1.5	OK
Curvature in plans is less than $4^\circ =$	0	OK
Cross-section of the bridge is consistent with one of the cross sections given by LRFD specs		OK

Barrier and wearing surface loads are equally distributed among the 4 beams

Barrier Wt	$W_t =$	0.150 k/f
Dead load of future wearing surface	$DW =$	0.263 k/f

LIVE LOADS		
Fire truck live load front load (Point A)	$P_{live} =$	48.0 kips
Fire truck live load back load (Point B)	$P_{live} =$	22.0 kips
distance between two loads		19.2 ft
distance from nearest edge to point A	$x_a =$	59.0 ft
distance from nearest edge to point B	$x_b =$	39.8 ft
LRFD Specifications: Art. 4.6.2.2.1		
Width of Deck Constant		OK
Number of beams is not less than four $N_b =$	4	OK
Beams are parallel and approximately of the same stiffness		OK
Roadway part of the overhang, $d_s \leq 3.0$ ft, $d_o =$	1.5	OK
Curvature in plans is less than $4^\circ =$	0	OK

Barrier and wearing surface loads are equally distributed among the 4 beams

Bridge Type-- "k" (LRFD Table 4.6.2.2.1-1)

Number of design lanes =  $w/12 = 3$  lanes

#### Distribution Factor for Bending Moment:

Beams spacing	$S =$	12.0 ft
Depth of concrete slab	$t_c =$	7.5 in
Beam Span	$L =$	120.0 ft
Number of Beams	$N_b =$	4
Modular ratio between beam & deck materials	$n =$	1.3229
Longitudinal stiffness parameter	$K_y =$	2,309,429.79 in <sup>4</sup>

at center span:		
$DFM = 0.75 + \left(\frac{S}{9.5}\right)^{0.6} + \left(\frac{S}{L}\right)^{0.2} + \left(\frac{K_y}{12 * L * t_c^3}\right)^{0.1}$		
	DFM =	0.905 lanes/beam

0.905 Controls

one design lane loaded:		
$DFM = 0.75 + \left(\frac{S}{14}\right)^{0.4} + \left(\frac{S}{L}\right)^{0.3} + \left(\frac{K_y}{12 * L * t_c^3}\right)^{0.1}$		
	DFM =	0.614 lanes/beam

#### Distribution Factor for Shear Force

both end spans and center span:		
$DFV = 0.2 + \left(\frac{S}{12}\right) - \left(\frac{S}{35}\right)^2$		
	DFV =	1.082 lanes/beam

1.082 Controls

one design lane loaded:		
$DFV = 0.36 + \left(\frac{S}{25}\right)$		
	DFV =	0.840 lanes/beam

from bottom	At Midspan		At Ends	
	No. of	Distance from Bottom	No. of	Distance from Bottom
layer 1	14	2	14	2
layer 2	14	3.5	14	3.5
layer 3	14	5	14	5
layer 4	10	6.5	8	6.5
layer 5	4	8	2	8
layer 6	2	10	-	-
layer 7	2	12	-	-
layer 8	2	14	-	-
layer 9	2	16	2	60
layer 10	-	-	2	62
layer 11	-	-	2	64
layer 12	-	-	2	66
layer 13	-	-	2	68
layer 14	-	-	2	70
	64		64	
<b>Harped Strand Group (included in above totals)</b>				
layer 3	2	6		
layer 4	2	8		
layer 5	2	10		
layer 6	2	12		
layer 7	2	14		
layer 8	2	16		

distance from the center of gravity of strands to the bottom fiber of the beam = 7% of the beam depth  
strand eccentricity at midspan =  $(y_b - y_{bs})$

$y_{bs} =$	5.44 in
$e_c =$	31.16 in

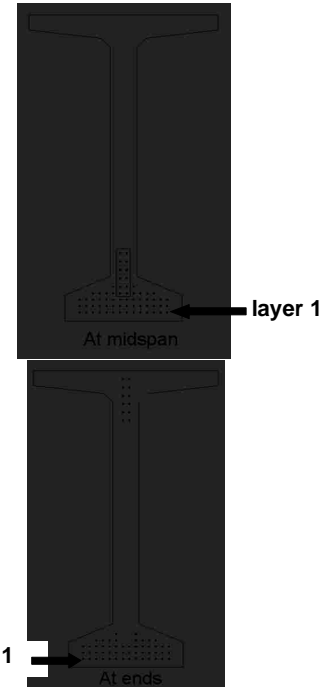
### Prestress Losses

#### ELASTIC SHORTENING

assumed loss	=	6.00%
--------------	---	-------

Force per strand at transfer

layer 1	=	17.0 kips
layer 2	=	17.0 kips
layer 3	=	17.0 kips
layer 4	=	17.0 kips
layer 5	=	17.0 kips
layer 6	=	17.0 kips
layer 7	=	17.0 kips
layer 8	=	17.0 kips
layer 9	=	17.0 kips
layer 10	=	17.0 kips
layer 11	=	17.0 kips
layer 12	=	17.0 kips
layer 13	=	17.0 kips
layer 14	=	17.0 kips



Total prestressing force at release

	at midspan	at endspan
$P_i =$	1088.0 kips	1054.0 kips
$f_{cgp} =$	2.412 ksi	2.307 ksi

Sum of concrete stresses at the center of gravity of prestressing tendons due to prestressing force at transfer and the self-weight of the member at sections of maximum moment

Loss due to shortening

	at midspan	at endspan
layer 1 $\Delta f_{PES} =$	13.9 ksi	13.3 ksi
layer 2 $\Delta f_{PES} =$	13.9 ksi	13.3 ksi
layer 3 $\Delta f_{PES} =$	13.9 ksi	13.3 ksi
layer 4 $\Delta f_{PES} =$	13.9 ksi	13.3 ksi
layer 5 $\Delta f_{PES} =$	13.9 ksi	13.3 ksi
layer 6 $\Delta f_{PES} =$	13.9 ksi	
layer 7 $\Delta f_{PES} =$	13.9 ksi	
layer 8 $\Delta f_{PES} =$	13.9 ksi	
layer 9 $\Delta f_{PES} =$	13.9 ksi	13.3 ksi
layer 10 $\Delta f_{PES} =$		13.3 ksi
layer 11 $\Delta f_{PES} =$		13.3 ksi
layer 12 $\Delta f_{PES} =$		13.3 ksi
layer 13 $\Delta f_{PES} =$		13.3 ksi
layer 14 $\Delta f_{PES} =$		13.3 ksi

SHRINKAGE		
Shrinkage = (17-0.15*Relative Humidity)	$\Delta f_{PSR} =$	6.5 ksi ← assume relative humidity = 70%

CREEP OF CONCRETE			
Change of stresses at center of gravity of prestressing due to permanent loads except the loads acting at time of applying prestressing force, calculated at the same section as $f_{csp}$	$\Delta f_{cdp} =$	1.587 ksi	
		<b>at midspan</b>	<b>at endspan</b>
loss due to creep	$\Delta f_{PCR} =$	17.8 ksi	16.6 ksi

RELAXATION OF PRESTRESSING STRANDS			
loss due to relaxation after transfer		<b>at midspan</b>	<b>at endspan</b>
layer 1	$\Delta f_{pR2} =$	2.9 ksi	2.9 ksi
layer 2	$\Delta f_{pR2} =$	2.9 ksi	2.9 ksi
layer 3	$\Delta f_{pR2} =$	2.9 ksi	2.9 ksi
layer 4	$\Delta f_{pR2} =$	2.9 ksi	2.9 ksi
layer 5	$\Delta f_{pR2} =$	2.9 ksi	2.9 ksi
layer 6	$\Delta f_{pR2} =$	2.9 ksi	
layer 7	$\Delta f_{pR2} =$	2.9 ksi	
layer 8	$\Delta f_{pR2} =$	2.9 ksi	
layer 9	$\Delta f_{pR2} =$	2.9 ksi	2.9 ksi
layer 10	$\Delta f_{pR2} =$		2.9 ksi
layer 11	$\Delta f_{pR2} =$		2.9 ksi
layer 12	$\Delta f_{pR2} =$		2.9 ksi
layer 13	$\Delta f_{pR2} =$		2.9 ksi
layer 14	$\Delta f_{pR2} =$		2.9 ksi

TOTAL LOSSES AT TRANSFER			
total loss $\Delta f_{pES} = \Delta f_{pi}$			
stress in tendons after transfer $f_{pt} = f_{pi} - \Delta f_{pi}$		<b>at midspan</b>	<b>at endspan</b>
layer 1	$f_{pt} =$	199.3 ksi	199.9 ksi
layer 2	$f_{pt} =$	199.3 ksi	199.9 ksi
layer 3	$f_{pt} =$	199.3 ksi	199.9 ksi
layer 4	$f_{pt} =$	199.3 ksi	199.9 ksi
layer 5	$f_{pt} =$	199.3 ksi	199.9 ksi
layer 6	$f_{pt} =$	199.3 ksi	
layer 7	$f_{pt} =$	199.3 ksi	
layer 8	$f_{pt} =$	199.3 ksi	
layer 9	$f_{pt} =$	199.3 ksi	199.9 ksi
layer 10	$f_{pt} =$		199.9 ksi
layer 11	$f_{pt} =$		199.9 ksi
layer 12	$f_{pt} =$		199.9 ksi
layer 13	$f_{pt} =$		199.9 ksi
layer 14	$f_{pt} =$		199.9 ksi
force per strand = $f_{pt} \times$ strand area		<b>at midspan</b>	<b>at endspan</b>
layer 1	=	16.9 kips	17.0 kips
layer 2	=	16.9 kips	17.0 kips
layer 3	=	16.9 kips	17.0 kips
layer 4	=	16.9 kips	17.0 kips
layer 5	=	16.9 kips	17.0 kips
layer 6	=	16.9 kips	
layer 7	=	16.9 kips	
layer 8	=	16.9 kips	
layer 9	=	16.9 kips	17.0 kips
layer 10	=		17.0 kips
layer 11	=		17.0 kips
layer 12	=		17.0 kips
layer 13	=		17.0 kips
layer 14	=		17.0 kips
Total prestressing force after transfer	$P_i =$	1047.8 kips	1054.0 kips

Initial loss =  $(\Delta f_{pi}) / (f_{pi})$

		at midspan	at endspan	
layer 1	% =	6.5%	6.2%	OK
layer 2	% =	6.5%	6.2%	OK
layer 3	% =	6.5%	6.2%	OK
layer 4	% =	6.5%	6.2%	OK
layer 5	% =	6.5%	6.2%	OK
layer 6	% =	6.5%		OK
layer 7	% =	6.5%		OK
layer 8	% =	6.5%		OK
layer 9	% =	6.5%	6.2%	OK
layer 10	% =		6.2%	OK
layer 11	% =		6.2%	OK
layer 12	% =		6.2%	OK
layer 13	% =		6.2%	OK
layer 14	% =		6.2%	OK

**TOTAL LOSSES AT SERVICE LOADS**

Total Losses		at midspan	at endspan
layer 1	$\Delta f_{pT} =$	41.1 ksi	40.5 ksi
layer 2	$\Delta f_{pT} =$	41.1 ksi	40.5 ksi
layer 3	$\Delta f_{pT} =$	41.1 ksi	40.5 ksi
layer 4	$\Delta f_{pT} =$	41.1 ksi	40.5 ksi
layer 5	$\Delta f_{pT} =$	41.1 ksi	40.5 ksi
layer 6	$\Delta f_{pT} =$	41.1 ksi	
layer 7	$\Delta f_{pT} =$	41.1 ksi	
layer 8	$\Delta f_{pT} =$	41.1 ksi	
layer 9	$\Delta f_{pT} =$	41.1 ksi	40.5 ksi
layer 10	$\Delta f_{pT} =$		40.5 ksi
layer 11	$\Delta f_{pT} =$		40.5 ksi
layer 12	$\Delta f_{pT} =$		40.5 ksi
layer 13	$\Delta f_{pT} =$		40.5 ksi
layer 14	$\Delta f_{pT} =$		40.5 ksi

Stress in tendon after all losses =  $f_{pi} - \Delta f_{pi}$

		at midspan	at endspan
layer 1	$f_{pe} =$	172.0 ksi	172.7 ksi
layer 2	$f_{pe} =$	172.0 ksi	172.7 ksi
layer 3	$f_{pe} =$	172.0 ksi	172.7 ksi
layer 4	$f_{pe} =$	172.0 ksi	172.7 ksi
layer 5	$f_{pe} =$	172.0 ksi	172.7 ksi
layer 6	$f_{pe} =$	172.0 ksi	
layer 7	$f_{pe} =$	172.0 ksi	
layer 8	$f_{pe} =$	172.0 ksi	
layer 9	$f_{pe} =$	172.0 ksi	172.7 ksi
layer 10	$f_{pe} =$		172.7 ksi
layer 11	$f_{pe} =$		172.7 ksi
layer 12	$f_{pe} =$		172.7 ksi
layer 13	$f_{pe} =$		172.7 ksi
layer 14	$f_{pe} =$		172.7 ksi

check prestressing stress limit at service limit state:  $f_{pe} \leq 0.8 \cdot f_{py}$

layer 1	=	205.4 ksi	OK
layer 2	=	205.4 ksi	OK
layer 3	=	205.4 ksi	OK
layer 4	=	205.4 ksi	OK
layer 5	=	205.4 ksi	OK
layer 6	=	205.4 ksi	OK
layer 7	=	205.4 ksi	OK
layer 8	=	205.4 ksi	OK
layer 9	=	205.4 ksi	OK
layer 10	=	205.4 ksi	OK
layer 11	=	205.4 ksi	OK
layer 12	=	205.4 ksi	OK
layer 13	=	205.4 ksi	OK
layer 14	=	205.4 ksi	OK

force per strand =  $f_{pe}$  \* strand area

		at midspan	at endspan
layer 1	=	14.6 kips	14.7 kips
layer 2	=	14.6 kips	14.7 kips
layer 3	=	14.6 kips	14.7 kips
layer 4	=	14.6 kips	14.7 kips
layer 5	=	14.6 kips	14.7 kips
layer 6	=	14.6 kips	
layer 7	=	14.6 kips	
layer 8	=	14.6 kips	
layer 9	=	14.6 kips	14.7 kips
layer 10	=		14.7 kips
layer 11	=		14.7 kips
layer 12	=		14.7 kips
layer 13	=		14.7 kips
layer 14	=		14.7 kips

Total prestressing force after all losses  $P_{pe} =$   
 Final losses, % =  $(\Delta f_{PT}) / (f_{pi})$

		at midspan	at endspan
$P_{pe} =$		935.9 kips	939.2 kips
layer 1	% =	19.3%	19.0%
layer 2	% =	19.3%	19.0%
layer 3	% =	19.3%	19.0%
layer 4	% =	19.3%	19.0%
layer 5	% =	19.3%	19.0%
layer 6	% =	19.3%	
layer 7	% =	19.3%	
layer 8	% =	19.3%	
layer 9	% =	19.3%	19.0%
layer 10	% =		19.0%
layer 11	% =		19.0%
layer 12	% =		19.0%
layer 13	% =		19.0%
layer 14	% =		19.0%
Average final losses, %	% =	19.3%	19.0%

### Stresses at Transfer

#### STRESS LIMITS FOR CONCRETE

Compression = $0.6f_{ci}$	$f_{ci} =$	3.300 ksi
Tension		
without bonded reinforcement = $-0.0948 \sqrt{f_{ci}} \leq -0.2$	$=$	-0.200 ksi
with bonded auxiliary reinforcement = $-0.22 \sqrt{f_{ci}}$	$=$	-0.016 ksi

#### STRESSES AT TRANSFER LENGTH SECTION

Transfer Length = $60 \times (\text{strand diameter})$	$=$	1.9 ft
Bending moment at transfer length	$M_g =$	87.7 ft-kips
center of 12 strands to top fiber of beam at the end	$=$	7.00 in
center of 12 strands to bottom fiber of beam at the harp point	$=$	11.00 in
center of 12 strands and top fiber of beam at transfer length	$=$	9.84 in
center of gravity of 32 strands and bottom fiber of beam	$=$	3.98 in
center of gravity of all strands and the bottom fiber of beam at transfer length	$=$	15.24 in
center of gravity of all strands and the bottom fiber of beam at the end	$=$	15.30 in
Eccentricity of the strand group at transfer length:	$e_h =$	21.36 in
Eccentricity at end of beam:	$e =$	21.30 in

Calcs for eccentricity (see 9.6.7.2)

$$f_t = \frac{P_i}{A} - \frac{P_i e}{S_t} + \frac{M_g}{S_t}$$

$$f_b = \frac{P_i}{A} + \frac{P_i e}{S_b} - \frac{M_g}{S_b}$$

		at midspan	at endspan
Top stress at top fiber of beam	$f_t =$	-0.017 ksi	-0.017 ksi
Bottom stress at bottom fiber of the beam	$f_b =$	2.906 ksi	2.906 ksi

OK  
OK



STRESSES AT HARP POINT			
Bending moment due to beam weight at 0.3L	$M_g =$	1188.0 ft-kips	
Top stress at top fiber of beam	$f_t =$	0.173 ksi	0.169 ksi
Bottom stress at bottom fiber of the beam	$f_b =$	2.736 ksi	2.621 ksi

OK  
OK

STRESSES AT MIDSPAN			
Bending moment due to beam weight at 0.5L	$M_g =$	1414.3 ft-kips	
Top stress at top fiber of beam	$f_t =$	0.320 ksi	0.345 ksi
Bottom stress at bottom fiber of the beam	$f_b =$	2.554 ksi	2.438 ksi

OK  
OK

#### HOLD-DOWN FORCES

assume stress in strand before losses =  $0.8f_u$

layer 1	=	227.4 ksi
layer 2	=	227.4 ksi
layer 3	=	227.4 ksi
layer 4	=	227.4 ksi
layer 5	=	227.4 ksi
layer 6	=	227.4 ksi
layer 7	=	227.4 ksi
layer 8	=	227.4 ksi
layer 9	=	227.4 ksi
layer 10	=	227.4 ksi
layer 11	=	227.4 ksi
layer 12	=	227.4 ksi
layer 13	=	227.4 ksi
layer 14	=	227.4 ksi

prestress force per strand before any losses:

layer 1	=	19.3 kips
layer 2	=	19.3 kips
layer 3	=	19.3 kips
layer 4	=	19.3 kips
layer 5	=	19.3 kips
layer 6	=	19.3 kips
layer 7	=	19.3 kips
layer 8	=	19.3 kips
layer 9	=	19.3 kips
layer 10	=	19.3 kips
layer 11	=	19.3 kips
layer 12	=	19.3 kips
layer 13	=	19.3 kips
layer 14	=	19.3 kips
Harp Angle	$\psi =$	7.2 °

Hold-down force/strand

layer 1	=	2.5 kips/strand
layer 2	=	2.5 kips/strand
layer 3	=	2.5 kips/strand
layer 4	=	2.5 kips/strand
layer 5	=	2.5 kips/strand
layer 6	=	2.5 kips/strand
layer 7	=	2.5 kips/strand
layer 8	=	2.5 kips/strand
layer 9	=	2.5 kips/strand
layer 10	=	2.5 kips/strand
layer 11	=	2.5 kips/strand
layer 12	=	2.5 kips/strand
layer 13	=	2.5 kips/strand
layer 14	=	2.5 kips/strand
Total hold-down force	=	30.45 kips

### Stresses at Service Loads

#### STRESS LIMITS FOR CONCRETE

##### Compression:

Due to permanent loads for load combination Service I

for the precast beam	=	3.150 ksi
for deck	=	1.800 ksi

Due to permanent and transient loads for load combination Service I

for the precast beam	=	4.200 ksi
for deck	=	2.400 ksi

##### Tension:

Load Combination Service III

for the precast beam	=	-0.016 ksi
----------------------	---	------------

#### STRESSES AT MIDSPAN

Compression stresses at top fiber of beam	at midspan	at endspan		
$f_i = \frac{P_{ps}}{A} - \frac{P_{ps}e}{S_i} + \frac{(M_D + M_{L1})}{S_i} + \frac{(M_{ps} + M_D)}{S_{ps}}$				
Due to permanent loads	$f_{i0} =$	2.105 ksi	2.102 ksi	OK
$f_{is} = \frac{P_{ps}}{A} - \frac{P_{ps}e}{S_i} + \frac{(M_D + M_{L1})}{S_i} + \frac{(M_{ps} + M_D)}{S_{ps}} + \frac{(M_{LL1})}{S_{ps}}$				
Due to permanent loads and transient loads	$f_{i0} =$	2.508 ksi	2.505 ksi	OK
Compression stresses at top fiber of deck	at midspan	at endspan		
$f_{tr} = \frac{(M_{ps} + M_D)}{S_{tr}}$				
Due to permanent loads	$f_{tr} =$	0.042 ksi	0.042 ksi	OK
$f_{tr} = \frac{(M_{ps} + M_D + M_{LL1})}{S_{tr}}$				
Due to permanent loads and transient loads	$f_{tr} =$	0.488 ksi	0.488 ksi	OK
Tension stresses at top fiber of deck	at midspan	at endspan		
$f_{tr} = \frac{P_{ps}}{A} + \frac{P_{ps}e}{S_i} - \frac{(M_D + M_{L1})}{S_i} - \frac{(M_{ps} + M_D + 0.8 * M_{LL1})}{S_{tr}}$				
Load Combination Service III	$f_{t0} =$	-0.792 ksi	-0.781 ksi	OK

### Strength Limit State

#### POSITIVE MOMENT SECTION

$M_u = 1.25DC + 1.5DW + 1.75(LL+IM)$	$M_u =$	8381.5 ft-kips
--------------------------------------	---------	----------------

effective length factor for compression members

layer 1	k =	0.27
layer 2	k =	0.27
layer 3	k =	0.27
layer 4	k =	0.27
layer 5	k =	0.27
layer 6	k =	0.27
layer 7	k =	0.27
layer 8	k =	0.27
layer 9	k =	0.27
layer 10	k =	0.27
layer 11	k =	0.27
layer 12	k =	0.27
layer 13	k =	0.27
layer 14	k =	0.27
	c =	4.6 ft-kips

average stress in prestressing steel

layer 1	$f_{ps} =$	279.4 ksi
layer 2	$f_{ps} =$	279.4 ksi
layer 3	$f_{ps} =$	279.4 ksi
layer 4	$f_{ps} =$	279.4 ksi
layer 5	$f_{ps} =$	279.4 ksi
layer 6	$f_{ps} =$	279.4 ksi
layer 7	$f_{ps} =$	279.4 ksi
layer 8	$f_{ps} =$	279.4 ksi
layer 9	$f_{ps} =$	279.4 ksi
layer 10	$f_{ps} =$	279.4 ksi
layer 11	$f_{ps} =$	279.4 ksi
layer 12	$f_{ps} =$	279.4 ksi
layer 13	$f_{ps} =$	279.4 ksi
layer 14	$f_{ps} =$	279.4 ksi

nominal flexure resistance

	$a =$	3.92 in	
$M_r = \Phi M_n, \Phi = 1.00$	$\Phi M_n =$	9196.5 ft-kips	OK
<b>NEGATIVE MOMENT SECTION</b>			
$M_u = 1.25DC+1.5DW+1.75(LL+IM)$	$M_u =$	-4837.2 ft-kips	
	$a =$	0.20 in	
	$\Phi M_n =$	5099.1 ft-kips	OK

### Shear Design

<b>CRITICAL SECTION AT 0.59</b>			
$V_u = 1.25DC+1.5DW+1.75(LL+IM)$	$V_u =$	405.0 kips	
$M_u = 1.25DC+1.5DW+1.75(LL+IM)$	$M_u =$	-2684.4 ft-kips	
or			
$V_u = 1.25DC+1.5DW+1.75(LL+IM)$	$V_u =$	364.8 kips	
$M_u = 1.25DC+1.5DW+1.75(LL+IM)$	$M_u =$	-2877.0 ft-kips	
max shear	$V_u =$	405.0 kips	
max moment	$M_u =$	2877.0 ft-kips	
Shear depth	$d_v =$	73.19 in	
Applied factored normal force at the section	$N_u =$	0	
Angle of diagonal compressive stresses	$\theta =$	36.00 °	

### STRAIN IN FLEXURAL TENSION REINFORCEMENT

$$\epsilon_s = \frac{\frac{M_u}{d_r} + \eta N_u + 0.5 V_u \cot \theta - A_{ps} f_{ps}}{E_s A_s + E_p A_{ps}} \leq 0.002$$

		at midspan	at endspan
resultant compressive stress at centroid	$f_{pc} =$	0.909 ksi	0.911 ksi

effective stress in prestressing strand after all losses

layer 1	$f_{po} =$	176.7 ksi	177.3 ksi
layer 2	$f_{po} =$	176.7 ksi	177.3 ksi
layer 3	$f_{po} =$	176.7 ksi	177.3 ksi
layer 4	$f_{po} =$	176.7 ksi	177.3 ksi
layer 5	$f_{po} =$	176.7 ksi	
layer 6	$f_{po} =$	176.7 ksi	
layer 7	$f_{po} =$	176.7 ksi	
layer 8	$f_{po} =$	176.7 ksi	
layer 9	$f_{po} =$		177.3 ksi
layer 10	$f_{po} =$		177.3 ksi
layer 11	$f_{po} =$		177.3 ksi
layer 12	$f_{po} =$		177.3 ksi
layer 13	$f_{po} =$		177.3 ksi
layer 14	$f_{po} =$		177.3 ksi

strain in flexural tension

		at midspan	at endspan
layer 1	$\epsilon_x =$	0.002000	0.002000
layer 2	$\epsilon_x =$	0.002000	0.002000
layer 3	$\epsilon_x =$	0.002000	0.002000
layer 4	$\epsilon_x =$	0.002000	0.002000
layer 5	$\epsilon_x =$	0.002000	
layer 6	$\epsilon_x =$	0.002000	
layer 7	$\epsilon_x =$	0.002000	
layer 8	$\epsilon_x =$	0.002000	
layer 9	$\epsilon_x =$		0.002000
layer 10	$\epsilon_x =$		0.002000
layer 11	$\epsilon_x =$		0.002000
layer 12	$\epsilon_x =$		0.002000
layer 13	$\epsilon_x =$		0.002000
layer 14	$\epsilon_x =$		0.002000

### Deflection and Camber

Deflection due to Prestressing Force at Transfer  
 Deflection due to Beam Self-Weight at Transfer  
 Deflection due to Beam Self-Weight at Erection  
 Deflection due to Haunch and Deck

		at midspan	at endspan
$\Delta_p =$		3.27 in	3.29 in
$\Delta_g =$		-1.49 in	
$\Delta_g =$		-1.44 in	
$\Delta_s =$		-1.95 in	

Deflection due to total self weight

$\Delta_{sw} =$		-0.11 in	
-----------------	--	----------	--

Total Deflection at transfer

$\Delta =$		1.79 in	1.81 in
Total Deflection at erection		3.24 in	3.27 in

Live load deflection limit = span/800

$=$		1.80 in	
-----	--	---------	--

Deflection due to live load and impact

$\Delta_L =$		-0.83 in	
--------------	--	----------	--

OK

Deflection due to fire truck

$\Delta_L =$		-0.7520 in	
--------------	--	------------	--

OK

Total Deflection after fire with fire truck

$\Delta =$		2.4129 in	
------------	--	-----------	--

**Parametric Design: I-5 Overpass Case Study**  
**Beam Design: 3/8" Strand**  
**Fire Exposure Status: Damaged**

(PCI Bridge Design Manual Section 9.6)

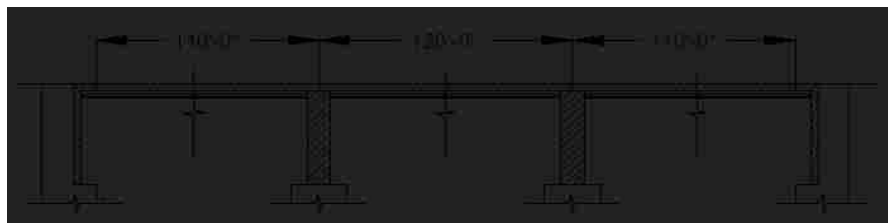


**Material Properties**

CAST-IN-PLACE SLAB			
Actual Thickness	$t_{as} =$		8.0 in
Wearing Surface	$=$		0.5 in
Structural thickness = Actual - Wearing Surface	$t_s =$		7.5 in
Compressive Strength	$f'_c =$		2.95 ksi
Unit Weight	$w_c =$		150.0 pcf
Stress factor of compression block	$\beta_1 =$		0.85

BEAMS: AASHTO-PCI, BT-72 BULB-TEE			
Strength at release	$f_{ci} =$		5.5 ksi
Strength at 28 days	$f'_c =$		7 ksi
Unit Weight	$w_c =$		150.0 pcf
Overall Beam Length:			
@ end spans	$L =$		110 ft
@ center span	$L =$		119 ft
Design Spans:			
Non-composite beam @ end spans	$L =$		109 ft
Non-composite beam @ center span	$L =$		118 ft
Composite beam @ end spans	$L =$		110 ft
Composite beam @ center span	$L =$		120 ft
Beam Spacing	$S =$		12 ft



**PRESTRESSING STRANDS**

Diameter of single strand	d =	0.4 in
Area of single strand	A =	0.085 in <sup>2</sup>
Temperature of Layer		
	layer 1 (bottom)	T = 68.00 °F
	layer 2	T = 68.00 °F
	layer 3	T = 68.00 °F
	layer 4	T = 68.00 °F
	layer 5	T = 68.00 °F
	layer 6	T = 68.00 °F
	layer 7	T = 68.00 °F
	layer 8	T = 68.00 °F
	layer 9	T = 68.00 °F
	layer 10	T = 68.00 °F
	layer 11	T = 68.00 °F
	layer 12	T = 68.00 °F
	layer 13	T = 68.00 °F
	layer 14	T = 68.00 °F
Ultimate Strength		
initial = 284 ksi	layer 1 (bottom)	f <sub>pu</sub> = 284 ksi
	layer 2	f <sub>pu</sub> = 284 ksi
	layer 3	f <sub>pu</sub> = 284 ksi
	layer 4	f <sub>pu</sub> = 284 ksi
	layer 5	f <sub>pu</sub> = 284 ksi
	layer 6	f <sub>pu</sub> = 284 ksi
	layer 7	f <sub>pu</sub> = 284 ksi
	layer 8	f <sub>pu</sub> = 284 ksi
	layer 9	f <sub>pu</sub> = 284 ksi
	layer 10	f <sub>pu</sub> = 284 ksi
	layer 11	f <sub>pu</sub> = 284 ksi
	layer 12	f <sub>pu</sub> = 284 ksi
	layer 13	f <sub>pu</sub> = 284 ksi
	layer 14	f <sub>pu</sub> = 284 ksi
Yield Strength		
initial = 257 ksi	layer 1 (bottom)	f <sub>py</sub> = 257 ksi
	layer 2	f <sub>py</sub> = 257 ksi
	layer 3	f <sub>py</sub> = 257 ksi
	layer 4	f <sub>py</sub> = 257 ksi
	layer 5	f <sub>py</sub> = 257 ksi
	layer 6	f <sub>py</sub> = 257 ksi
	layer 7	f <sub>py</sub> = 257 ksi
	layer 8	f <sub>py</sub> = 257 ksi
	layer 9	f <sub>py</sub> = 257 ksi
	layer 10	f <sub>py</sub> = 257 ksi
	layer 11	f <sub>py</sub> = 257 ksi
	layer 12	f <sub>py</sub> = 257 ksi
	layer 13	f <sub>py</sub> = 257 ksi
	layer 14	f <sub>py</sub> = 257 ksi
<b>Stress Limits:</b>		
before transfer ≤ 0.75f <sub>pu</sub> (initial = 213.2)	layer 1 (bottom)	f <sub>pi</sub> = 213.2 ksi
	layer 2	f <sub>pi</sub> = 213.2 ksi
	layer 3	f <sub>pi</sub> = 213.2 ksi
	layer 4	f <sub>pi</sub> = 213.2 ksi
	layer 5	f <sub>pi</sub> = 213.2 ksi
	layer 6	f <sub>pi</sub> = 213.2 ksi
	layer 7	f <sub>pi</sub> = 213.2 ksi
	layer 8	f <sub>pi</sub> = 213.2 ksi
	layer 9	f <sub>pi</sub> = 213.2 ksi
	layer 10	f <sub>pi</sub> = 213.2 ksi
	layer 11	f <sub>pi</sub> = 213.2 ksi
	layer 12	f <sub>pi</sub> = 213.2 ksi
	layer 13	f <sub>pi</sub> = 213.2 ksi
	layer 14	f <sub>pi</sub> = 213.2 ksi

at service limit state (after all losses)  $\leq 0.80f_{py}$  (initial = 205.4)

layer 1 (bottom)	$f_{pe} =$	205.4 ksi
layer 2	$f_{pe} =$	205.4 ksi
layer 3	$f_{pe} =$	205.4 ksi
layer 4	$f_{pe} =$	205.4 ksi
layer 5	$f_{pe} =$	205.4 ksi
layer 6	$f_{pe} =$	205.4 ksi
layer 7	$f_{pe} =$	205.4 ksi
layer 8	$f_{pe} =$	205.4 ksi
layer 9	$f_{pe} =$	205.4 ksi
layer 10	$f_{pe} =$	205.4 ksi
layer 11	$f_{pe} =$	205.4 ksi
layer 12	$f_{pe} =$	205.4 ksi
layer 13	$f_{pe} =$	205.4 ksi
layer 14	$f_{pe} =$	205.4 ksi

Modulus of Elasticity

initial = 25898 ksi

layer 1 (bottom)	E =	25898.0 ksi
layer 2	E =	25898.0 ksi
layer 3	E =	25898.0 ksi
layer 4	E =	25898.0 ksi
layer 5	E =	25898.0 ksi
layer 6	E =	25898.0 ksi
layer 7	E =	25898.0 ksi
layer 8	E =	25898.0 ksi
layer 9	E =	25898.0 ksi
layer 10	E =	25898.0 ksi
layer 11	E =	25898.0 ksi
layer 12	E =	25898.0 ksi
layer 13	E =	25898.0 ksi
layer 14	E =	25898.0 ksi

### MILD STEEL REINFORCING BARS

Yield Strength

Layer 1 (Bottom)	$f_y =$	60.0 ksi	68.00 °F
Layer 2 (Top)	$f_y =$	37.8 ksi	1508.00 °F

Modulus of Elasticity

Layer 1 (Bottom)	E =	29000.0 ksi
Layer 2 (Top)	E =	29000.0 ksi

Layer 1 (Bottom)

Area of steel at midspan (effective flange)	$A_{sm} =$	2.79 in <sup>2</sup>
Area of steel at endspan (effective flange)	$A_{se} =$	2.48 in <sup>2</sup>
Area of temperature and shrinkage steel (12" width)	$A_s =$	0.31 in <sup>2</sup>

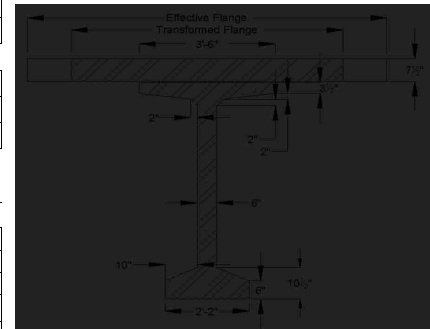
Layer 2 (Top)

Area of steel at midspan (effective flange)	$A_{sm} =$	12.6 in <sup>2</sup>
Area of steel at endspan (effective flange)	$A_{se} =$	12.4 in <sup>2</sup>
Area of temperature and shrinkage steel (12" width)	$A_s =$	0.2 in <sup>2</sup>

### Cross-sectional Properties

#### NON-COMPOSITE BEAM

Area of cross-section of beam	A =	767.0 in <sup>2</sup>
Overall depth of beam	H =	72.0 in
Moment of Inertia	I =	539,947 in <sup>4</sup>
Distance from centroid to extreme <b>bottom</b> fiber	$y_b =$	36.6 in
Distance from centroid to extreme <b>top</b> fiber	$y_t =$	35.4 in
Section modulus for the extreme <b>bottom</b> fiber	$S_b =$	14915.0 in <sup>3</sup>
Section modulus for the extreme <b>top</b> fiber	$S_t =$	15421.0 in <sup>3</sup>
Weight	$W_t =$	799.0 plf
Modulus of Elasticity = $33000 \cdot (W_c^{1.5}) \cdot (\sqrt{f_c})$		
cast-in-place concrete deck	$E_{cs} =$	3293 ksi
precast beam at release	$E_{ci} =$	4496 ksi
precast beam at service loads	$E_c =$	5072 ksi



### COMPOSITE BEAM AT MIDSPAN

Effective Flange Width	$b_f =$	111.0 in	*min of three criteria
Modular Ratio = $E_{cs}/E_c$	$n =$	0.6492	
Transformed flange width	$=$	72.1 in	
Transformed flange area	$=$	540.4 in <sup>2</sup>	
Transformed haunch width	$=$	27.3 in	
Transformed haunch area	$=$	13.6 in <sup>2</sup>	
Deck-distance to top fiber	$y_t =$	5.00 in	

	Transformed Area	$y_b$	$Ay_b$	$A(y_{bc}-y_b)^2$	I	$I + A(y_{bc}-y_b)^2$
Beam	767.0 in <sup>2</sup>	36.60 in	28,072.2 in <sup>3</sup>	198,297 in <sup>4</sup>	539,947 in <sup>4</sup>	738,244 in <sup>4</sup>
Haunch	13.6 in <sup>2</sup>	72.25 in	985.0 in <sup>3</sup>	5,222 in <sup>4</sup>	0.28 in <sup>4</sup>	5,222 in <sup>4</sup>
Deck	540.4 in <sup>2</sup>	75.01 in	40,535.6 in <sup>3</sup>	269,381 in <sup>4</sup>	1,200 in <sup>4</sup>	270,581 in <sup>4</sup>
Total	1321.1 in <sup>2</sup>		69,592.7 in <sup>3</sup>			1,014,046 in <sup>4</sup>

Total area of Composite Section	$A_c =$	1321 in <sup>2</sup>
Overall Depth of the Composite Section	$h_c =$	80 in
Moment of Inertia	$I_c =$	1,014,046 in <sup>4</sup>
Distance from centroid to extreme <u>bottom</u> fiber of beam	$y_{bc} =$	52.68 in
Distance from centroid to extreme <u>top</u> fiber of beam	$y_{tg} =$	19.32 in
Distance from centroid to extreme <u>top</u> fiber of slab	$y_{tc} =$	27.32 in
Section modulus for the extreme <u>bottom</u> fiber of beam	$S_{bc} =$	19,249.5 in <sup>3</sup>
Section modulus for the extreme <u>top</u> fiber of beam	$S_{tg} =$	52,484.2 in <sup>3</sup>
Section modulus for the extreme <u>top</u> fiber slab	$S_{tc} =$	57,174.2 in <sup>3</sup>

### COMPOSITE BEAM AT ENDSPAN

Effective Flange Width	$b_f =$	106.6 in	*min of three criteria
Modular Ratio = $E_{cs}/E_c$	$n =$	0.6492	
Transformed flange width	$=$	69.2 in	
Transformed flange area	$=$	519.0 in <sup>2</sup>	
Transformed haunch width	$=$	27.3 in	
Transformed haunch area	$=$	13.6 in <sup>2</sup>	
Deck-distance to top fiber	$y_{td} =$	5.11 in	

	Transformed Area	$y_t$	$Ay_t$	$A(y_{bc}-y_t)^2$	I	$I + A(y_{bc}-y_t)^2$
Beam	767.0 in <sup>2</sup>	36.60 in	28,072.2 in <sup>3</sup>	247,166 in <sup>4</sup>	539,947 in <sup>4</sup>	787,113 in <sup>4</sup>
Haunch	13.6 in <sup>2</sup>	72.25 in	985.0 in <sup>3</sup>	4,393 in <sup>4</sup>	0.28 in <sup>4</sup>	4,393 in <sup>4</sup>
Deck	519.0 in <sup>2</sup>	77.61 in	40,280.8 in <sup>3</sup>	167,253 in <sup>4</sup>	1,049 in <sup>4</sup>	168,302 in <sup>4</sup>
Total	1299.6 in <sup>2</sup>		69,338.0 in <sup>3</sup>			959,808 in <sup>4</sup>

Total area of Composite Section	$A_c =$	1300 in <sup>2</sup>
Overall Depth of the Composite Section	$h_c =$	80 in
Moment of Inertia	$I_c =$	959,808 in <sup>4</sup>
Distance from centroid to extreme <u>bottom</u> fiber of beam	$y_{bc} =$	53.35 in
Distance from centroid to extreme <u>top</u> fiber of beam	$y_{tg} =$	18.65 in
Distance from centroid to extreme <u>top</u> fiber of slab	$y_{tc} =$	26.65 in
Section modulus for the extreme <u>bottom</u> fiber of beam	$S_{bc} =$	17,990.3 in <sup>3</sup>
Section modulus for the extreme <u>top</u> fiber of beam	$S_{tg} =$	51,467.9 in <sup>3</sup>
Section modulus for the extreme <u>top</u> fiber slab	$S_{tc} =$	36,017.1 in <sup>3</sup>

### Shear Forces and Bending Moments

#### DEAD LOADS

Beam self-weight	$w_{beam} =$	0.799 k/f
8 in. deck weight	$w_{deck} =$	1.200 k/f
1/2 in. haunch weight	$w_{haunch} =$	0.022 k/f

LRFD Specifications: Art. 4.6.2.2.1

Width of Deck Constant	4	OK
Number of beams is not less than four $N_b =$	4	OK
Roadway part of the overhang, $d_b \leq 3.0$ ft, $d_b =$	1.5	OK
Curvature in plans is less than 4° =	0	OK
Cross-section of the bridge is consistent with one of the cross sections given by LRFD specs		OK

Barrier and wearing surface loads are equally distributed among the 4 beams

Barrier Wt	$W_t =$	0.150 k/f
Dead load of future wearing surface	$DW =$	0.263 k/f



LIVE LOADS		
Fire truck live load front load (Point A)	$P_{live} =$	48.0 kips
Fire truck live load back load (Point B)	$P_{live} =$	22.0 kips
distance between two loads		19.2 ft
distance from nearest edge to point A	$x_a =$	59.0 ft
distance from nearest edge to point B	$x_b =$	39.8 ft
LRFD Specifications: Art. 4.6.2.2.1		
Width of Deck Constant		OK
Number of beams is not less than four $N_b =$	4	OK
Beams are parallel and approximately of the same stiffness		OK
Roadway part of the overhang, $d_s \leq 3.0$ ft, $d_o =$	1.5	OK
Curvature in plans is less than $4^\circ =$	0	OK

Barrier and wearing surface loads are equally distributed among the 4 beams

Bridge Type-- "k" (LRFD Table 4.6.2.2.1-1)

Number of design lanes =  $w/12 =$  3 lanes

#### Distribution Factor for Bending Moment:

Beams spacing	$S =$	12.0 ft
Depth of concrete slab	$t_c =$	7.5 in
Beam Span	$L =$	120.0 ft
Number of Beams	$N_b =$	4
Modular ratio between beam & deck materials	$n =$	1.5404
Longitudinal stiffness parameter	$K_y =$	2,689,204.22 in <sup>4</sup>

at center span:		
$DFM = 0.75 + \left(\frac{S}{9.5}\right)^{0.6} + \left(\frac{S}{L}\right)^{0.2} + \left(\frac{K_y}{12 * L * t_c^3}\right)^{0.1}$		
	DFM =	0.917 lanes/beam

0.905 Controls

one design lane loaded:		
$DFM = 0.75 + \left(\frac{S}{14}\right)^{0.4} + \left(\frac{S}{L}\right)^{0.3} + \left(\frac{K_y}{12 * L * t_c^3}\right)^{0.1}$		
	DFM =	0.622 lanes/beam

#### Distribution Factor for Shear Force

both end spans and center span:		
$DFV = 0.2 + \left(\frac{S}{12}\right) - \left(\frac{S}{35}\right)^2$		
	DFV =	1.082 lanes/beam

1.082 Controls

one design lane loaded:		
$DFV = 0.36 + \left(\frac{S}{25}\right)$		
	DFV =	0.840 lanes/beam

from bottom	At Midspan		At Ends	
	No. of	Distance from Bottom	No. of	Distance from Bottom
layer 1	14	2	14	2
layer 2	14	3.5	14	3.5
layer 3	14	5	14	5
layer 4	10	6.5	8	6.5
layer 5	4	8	2	8
layer 6	2	10	-	-
layer 7	2	12	-	-
layer 8	2	14	-	-
layer 9	2	16	2	60
layer 10	-	-	2	62
layer 11	-	-	2	64
layer 12	-	-	2	66
layer 13	-	-	2	68
layer 14	-	-	2	70
	64		64	
<b>Harped Strand Group (included in above totals)</b>				
layer 3	2	6		
layer 4	2	8		
layer 5	2	10		
layer 6	2	12		
layer 7	2	14		
layer 8	2	16		

distance from the center of gravity of strands to the bottom fiber of the beam = 7% of the beam depth  
strand eccentricity at midspan =  $(y_b - y_{bs})$

$y_{bs} =$	5.44 in
$e_c =$	31.16 in

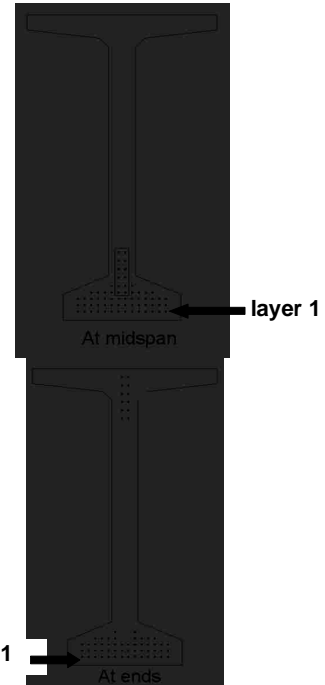
### Prestress Losses

#### ELASTIC SHORTENING

assumed loss	=	6.00%
--------------	---	-------

Force per strand at transfer

layer 1	=	17.0 kips
layer 2	=	17.0 kips
layer 3	=	17.0 kips
layer 4	=	17.0 kips
layer 5	=	17.0 kips
layer 6	=	17.0 kips
layer 7	=	17.0 kips
layer 8	=	17.0 kips
layer 9	=	17.0 kips
layer 10	=	17.0 kips
layer 11	=	17.0 kips
layer 12	=	17.0 kips
layer 13	=	17.0 kips
layer 14	=	17.0 kips



		at midspan	at endspan
Total prestressing force at release	$P_i =$	1088.0 kips	1054.0 kips
Sum of concrete stresses at the center of gravity of prestressing tendons due to prestressing force at transfer and the self-weight of the member at sections of maximum moment	$f_{cgp} =$	2.412 ksi	2.307 ksi

Loss due to shortening

		at midspan	at endspan
layer 1	$\Delta f_{PES} =$	13.9 ksi	13.3 ksi
layer 2	$\Delta f_{PES} =$	13.9 ksi	13.3 ksi
layer 3	$\Delta f_{PES} =$	13.9 ksi	13.3 ksi
layer 4	$\Delta f_{PES} =$	13.9 ksi	13.3 ksi
layer 5	$\Delta f_{PES} =$	13.9 ksi	13.3 ksi
layer 6	$\Delta f_{PES} =$	13.9 ksi	
layer 7	$\Delta f_{PES} =$	13.9 ksi	
layer 8	$\Delta f_{PES} =$	13.9 ksi	
layer 9	$\Delta f_{PES} =$	13.9 ksi	13.3 ksi
layer 10	$\Delta f_{PES} =$		13.3 ksi
layer 11	$\Delta f_{PES} =$		13.3 ksi
layer 12	$\Delta f_{PES} =$		13.3 ksi
layer 13	$\Delta f_{PES} =$		13.3 ksi
layer 14	$\Delta f_{PES} =$		13.3 ksi

SHRINKAGE		
Shrinkage = (17-0.15*Relative Humidity)	$\Delta f_{PSR} =$	6.5 ksi ← assume relative humidity = 70%

CREEP OF CONCRETE			
Change of stresses at center of gravity of prestressing due to permanent loads except the loads acting at time of applying prestressing force, calculated at the same section as $f_{csp}$	$\Delta f_{cdp} =$	1.593 ksi	
		at midspan	at endspan
loss due to creep	$\Delta f_{PCR} =$	17.8 ksi	16.5 ksi

RELAXATION OF PRESTRESSING STRANDS			
loss due to relaxation after transfer		at midspan	at endspan
layer 1	$\Delta f_{pR2} =$	2.9 ksi	2.9 ksi
layer 2	$\Delta f_{pR2} =$	2.9 ksi	2.9 ksi
layer 3	$\Delta f_{pR2} =$	2.9 ksi	2.9 ksi
layer 4	$\Delta f_{pR2} =$	2.9 ksi	2.9 ksi
layer 5	$\Delta f_{pR2} =$	2.9 ksi	2.9 ksi
layer 6	$\Delta f_{pR2} =$	2.9 ksi	
layer 7	$\Delta f_{pR2} =$	2.9 ksi	
layer 8	$\Delta f_{pR2} =$	2.9 ksi	
layer 9	$\Delta f_{pR2} =$	2.9 ksi	2.9 ksi
layer 10	$\Delta f_{pR2} =$		2.9 ksi
layer 11	$\Delta f_{pR2} =$		2.9 ksi
layer 12	$\Delta f_{pR2} =$		2.9 ksi
layer 13	$\Delta f_{pR2} =$		2.9 ksi
layer 14	$\Delta f_{pR2} =$		2.9 ksi

TOTAL LOSSES AT TRANSFER			
total loss $\Delta f_{pES} = \Delta f_{pi}$			
stress in tendons after transfer $f_{pt} = f_{pi} - \Delta f_{pi}$		at midspan	at endspan
layer 1	$f_{pt} =$	199.3 ksi	199.9 ksi
layer 2	$f_{pt} =$	199.3 ksi	199.9 ksi
layer 3	$f_{pt} =$	199.3 ksi	199.9 ksi
layer 4	$f_{pt} =$	199.3 ksi	199.9 ksi
layer 5	$f_{pt} =$	199.3 ksi	199.9 ksi
layer 6	$f_{pt} =$	199.3 ksi	
layer 7	$f_{pt} =$	199.3 ksi	
layer 8	$f_{pt} =$	199.3 ksi	
layer 9	$f_{pt} =$	199.3 ksi	199.9 ksi
layer 10	$f_{pt} =$		199.9 ksi
layer 11	$f_{pt} =$		199.9 ksi
layer 12	$f_{pt} =$		199.9 ksi
layer 13	$f_{pt} =$		199.9 ksi
layer 14	$f_{pt} =$		199.9 ksi
force per strand = $f_{pt} \times$ strand area		at midspan	at endspan
layer 1	=	16.9 kips	17.0 kips
layer 2	=	16.9 kips	17.0 kips
layer 3	=	16.9 kips	17.0 kips
layer 4	=	16.9 kips	17.0 kips
layer 5	=	16.9 kips	17.0 kips
layer 6	=	16.9 kips	
layer 7	=	16.9 kips	
layer 8	=	16.9 kips	
layer 9	=	16.9 kips	17.0 kips
layer 10	=		17.0 kips
layer 11	=		17.0 kips
layer 12	=		17.0 kips
layer 13	=		17.0 kips
layer 14	=		17.0 kips
Total prestressing force after transfer	$P_i =$	1047.8 kips	1054.0 kips

Initial loss =  $(\Delta f_{pi}) / (f_{pi})$

		at midspan	at endspan
layer 1	% =	6.5%	6.2%
layer 2	% =	6.5%	6.2%
layer 3	% =	6.5%	6.2%
layer 4	% =	6.5%	6.2%
layer 5	% =	6.5%	6.2%
layer 6	% =	6.5%	
layer 7	% =	6.5%	
layer 8	% =	6.5%	
layer 9	% =	6.5%	6.2%
layer 10	% =		6.2%
layer 11	% =		6.2%
layer 12	% =		6.2%
layer 13	% =		6.2%
layer 14	% =		6.2%

OK  
OK  
OK  
OK  
OK  
OK  
OK  
OK  
OK  
OK  
OK  
OK  
OK  
OK

**TOTAL LOSSES AT SERVICE LOADS**

Total Losses		at midspan	at endspan
layer 1	$\Delta f_{pT} =$	41.1 ksi	40.5 ksi
layer 2	$\Delta f_{pT} =$	41.1 ksi	40.5 ksi
layer 3	$\Delta f_{pT} =$	41.1 ksi	40.5 ksi
layer 4	$\Delta f_{pT} =$	41.1 ksi	40.5 ksi
layer 5	$\Delta f_{pT} =$	41.1 ksi	40.5 ksi
layer 6	$\Delta f_{pT} =$	41.1 ksi	
layer 7	$\Delta f_{pT} =$	41.1 ksi	
layer 8	$\Delta f_{pT} =$	41.1 ksi	
layer 9	$\Delta f_{pT} =$	41.1 ksi	40.5 ksi
layer 10	$\Delta f_{pT} =$		40.5 ksi
layer 11	$\Delta f_{pT} =$		40.5 ksi
layer 12	$\Delta f_{pT} =$		40.5 ksi
layer 13	$\Delta f_{pT} =$		40.5 ksi
layer 14	$\Delta f_{pT} =$		40.5 ksi

Stress in tendon after all losses =  $f_{pi} - \Delta f_{pi}$

		at midspan	at endspan
layer 1	$f_{pe} =$	172.1 ksi	172.7 ksi
layer 2	$f_{pe} =$	172.1 ksi	172.7 ksi
layer 3	$f_{pe} =$	172.1 ksi	172.7 ksi
layer 4	$f_{pe} =$	172.1 ksi	172.7 ksi
layer 5	$f_{pe} =$	172.1 ksi	172.7 ksi
layer 6	$f_{pe} =$	172.1 ksi	
layer 7	$f_{pe} =$	172.1 ksi	
layer 8	$f_{pe} =$	172.1 ksi	
layer 9	$f_{pe} =$	172.1 ksi	172.7 ksi
layer 10	$f_{pe} =$		172.7 ksi
layer 11	$f_{pe} =$		172.7 ksi
layer 12	$f_{pe} =$		172.7 ksi
layer 13	$f_{pe} =$		172.7 ksi
layer 14	$f_{pe} =$		172.7 ksi

check prestressing stress limit at service limit state:  $f_{pe} \leq 0.8 \cdot f_{py}$

layer 1	=	205.4 ksi
layer 2	=	205.4 ksi
layer 3	=	205.4 ksi
layer 4	=	205.4 ksi
layer 5	=	205.4 ksi
layer 6	=	205.4 ksi
layer 7	=	205.4 ksi
layer 8	=	205.4 ksi
layer 9	=	205.4 ksi
layer 10	=	205.4 ksi
layer 11	=	205.4 ksi
layer 12	=	205.4 ksi
layer 13	=	205.4 ksi
layer 14	=	205.4 ksi

OK  
OK  
OK  
OK  
OK  
OK  
OK  
OK  
OK  
OK  
OK  
OK  
OK  
OK

force per strand =  $f_{pe}$  \* strand area

		at midspan	at endspan
layer 1	=	14.6 kips	14.7 kips
layer 2	=	14.6 kips	14.7 kips
layer 3	=	14.6 kips	14.7 kips
layer 4	=	14.6 kips	14.7 kips
layer 5	=	14.6 kips	14.7 kips
layer 6	=	14.6 kips	
layer 7	=	14.6 kips	
layer 8	=	14.6 kips	
layer 9	=	14.6 kips	14.7 kips
layer 10	=		14.7 kips
layer 11	=		14.7 kips
layer 12	=		14.7 kips
layer 13	=		14.7 kips
layer 14	=		14.7 kips

Total prestressing force after all losses  $P_{pe} =$   
 Final losses, % =  $(\Delta f_{PT}) / (f_{pi})$

		at midspan	at endspan
$P_{pe} =$		936.2 kips	939.5 kips
layer 1	% =	19.3%	19.0%
layer 2	% =	19.3%	19.0%
layer 3	% =	19.3%	19.0%
layer 4	% =	19.3%	19.0%
layer 5	% =	19.3%	19.0%
layer 6	% =	19.3%	
layer 7	% =	19.3%	
layer 8	% =	19.3%	
layer 9	% =	19.3%	19.0%
layer 10	% =		19.0%
layer 11	% =		19.0%
layer 12	% =		19.0%
layer 13	% =		19.0%
layer 14	% =		19.0%
Average final losses, %	% =	19.3%	19.0%

### Stresses at Transfer

#### STRESS LIMITS FOR CONCRETE

Compression = $0.6f_{ci}$	$f_{ci} =$	3.300 ksi
Tension		
without bonded reinforcement = $-0.0948 \sqrt{f_{ci}} \leq -0.2$	$=$	-0.200 ksi
with bonded auxiliary reinforcement = $-0.22 \sqrt{f_{ci}}$	$=$	-0.016 ksi

#### STRESSES AT TRANSFER LENGTH SECTION

Transfer Length = $60 \times$ (strand diameter)	$=$	1.9 ft
Bending moment at transfer length	$M_g =$	87.7 ft-kips
center of 12 strands to top fiber of beam at the end	$=$	7.00 in
center of 12 strands to bottom fiber of beam at the harp point	$=$	11.00 in
center of 12 strands and top fiber of beam at transfer length	$=$	9.84 in
center of gravity of 32 strands and bottom fiber of beam	$=$	3.98 in
center of gravity of all strands and the bottom fiber of beam at transfer length	$=$	15.24 in
center of gravity of all strands and the bottom fiber of beam at the end	$=$	15.30 in
Eccentricity of the strand group at transfer length:	$e_h =$	21.36 in
Eccentricity at end of beam:	$e =$	21.30 in

Calcs for eccentricity (see 9.6.7.2)

$$f_t = \frac{P_i}{A} - \frac{P_i e}{S_t} + \frac{M_g}{S_t}$$

$$f_b = \frac{P_i}{A} + \frac{P_i e}{S_b} - \frac{M_g}{S_b}$$

		at midspan	at endspan
Top stress at top fiber of beam	$f_t =$	-0.017 ksi	-0.017 ksi
Bottom stress at bottom fiber of the beam	$f_b =$	2.906 ksi	2.906 ksi

OK  
OK

STRESSES AT HARP POINT			
Bending moment due to beam weight at 0.3L	$M_g =$	1188.0 ft-kips	
Top stress at top fiber of beam	$f_t =$	0.173 ksi	0.169 ksi
Bottom stress at bottom fiber of the beam	$f_b =$	2.736 ksi	2.621 ksi

OK  
OK

STRESSES AT MIDSPAN			
Bending moment due to beam weight at 0.5L	$M_g =$	1414.3 ft-kips	
Top stress at top fiber of beam	$f_t =$	0.320 ksi	0.345 ksi
Bottom stress at bottom fiber of the beam	$f_b =$	2.554 ksi	2.438 ksi

OK  
OK

#### HOLD-DOWN FORCES

assume stress in strand before losses =  $0.8f_u$

layer 1	=	227.4 ksi
layer 2	=	227.4 ksi
layer 3	=	227.4 ksi
layer 4	=	227.4 ksi
layer 5	=	227.4 ksi
layer 6	=	227.4 ksi
layer 7	=	227.4 ksi
layer 8	=	227.4 ksi
layer 9	=	227.4 ksi
layer 10	=	227.4 ksi
layer 11	=	227.4 ksi
layer 12	=	227.4 ksi
layer 13	=	227.4 ksi
layer 14	=	227.4 ksi

prestress force per strand before any losses:

layer 1	=	19.3 kips
layer 2	=	19.3 kips
layer 3	=	19.3 kips
layer 4	=	19.3 kips
layer 5	=	19.3 kips
layer 6	=	19.3 kips
layer 7	=	19.3 kips
layer 8	=	19.3 kips
layer 9	=	19.3 kips
layer 10	=	19.3 kips
layer 11	=	19.3 kips
layer 12	=	19.3 kips
layer 13	=	19.3 kips
layer 14	=	19.3 kips
Harp Angle	$\psi =$	7.2 °

Hold-down force/strand

layer 1	=	2.5 kips/strand
layer 2	=	2.5 kips/strand
layer 3	=	2.5 kips/strand
layer 4	=	2.5 kips/strand
layer 5	=	2.5 kips/strand
layer 6	=	2.5 kips/strand
layer 7	=	2.5 kips/strand
layer 8	=	2.5 kips/strand
layer 9	=	2.5 kips/strand
layer 10	=	2.5 kips/strand
layer 11	=	2.5 kips/strand
layer 12	=	2.5 kips/strand
layer 13	=	2.5 kips/strand
layer 14	=	2.5 kips/strand
Total hold-down force	=	30.45 kips

### Stresses at Service Loads

#### STRESS LIMITS FOR CONCRETE

##### Compression:

Due to permanent loads for load combination Service I

for the precast beam	=	3.150 ksi
for deck	=	1.328 ksi

Due to permanent and transient loads for load combination Service I

for the precast beam	=	4.200 ksi
for deck	=	1.770 ksi

##### Tension:

Load Combination Service III

for the precast beam	=	-0.016 ksi
----------------------	---	------------

#### STRESSES AT MIDSPAN

Compression stresses at top fiber of beam	at midspan	at endspan		
$f_i = \frac{P_{ps}}{A} - \frac{P_{ps}e}{S_i} + \frac{(M_D + M_{L1})}{S_i} + \frac{(M_{ps} + M_D)}{S_{ps}}$				
Due to permanent loads	$f_{i0} =$	2.112 ksi	2.110 ksi	OK
$f_{is} = \frac{P_{ps}}{A} - \frac{P_{ps}e}{S_i} + \frac{(M_D + M_{L1})}{S_i} + \frac{(M_{ps} + M_D)}{S_{ps}} + \frac{(M_{LL1})}{S_{ps}}$				
Due to permanent loads and transient loads	$f_{i0} =$	2.596 ksi	2.593 ksi	OK
Compression stresses at top fiber of deck	at midspan	at endspan		
$f_{tr} = \frac{(M_{ps} + M_D)}{S_{tr}}$				
Due to permanent loads	$f_{tr} =$	0.042 ksi	0.042 ksi	OK
$f_{tr} = \frac{(M_{ps} + M_D + M_{LL1})}{S_{tr}}$				
Due to permanent loads and transient loads	$f_{tr} =$	0.486 ksi	0.486 ksi	OK
Tension stresses at top fiber of deck	at midspan	at endspan		
$f_{tr} = \frac{P_{ps}}{A} + \frac{P_{ps}e}{S_i} - \frac{(M_D + M_{L1})}{S_i} - \frac{(M_{ps} + M_D + 0.8 * M_{LL1})}{S_{tr}}$				
Load Combination Service III	$f_{t0} =$	-0.834 ksi	-0.822 ksi	OK

### Strength Limit State

#### POSITIVE MOMENT SECTION

$M_u = 1.25DC + 1.5DW + 1.75(LL + IM)$	$M_u =$	8381.5 ft-kips
--	---------	----------------

effective length factor for compression members

layer 1	k =	0.27
layer 2	k =	0.27
layer 3	k =	0.27
layer 4	k =	0.27
layer 5	k =	0.27
layer 6	k =	0.27
layer 7	k =	0.27
layer 8	k =	0.27
layer 9	k =	0.27
layer 10	k =	0.27
layer 11	k =	0.27
layer 12	k =	0.27
layer 13	k =	0.27
layer 14	k =	0.27
	c =	6.2 ft-kips

average stress in prestressing steel

layer 1	$f_{ps} =$	277.7 ksi
layer 2	$f_{ps} =$	277.7 ksi
layer 3	$f_{ps} =$	277.7 ksi
layer 4	$f_{ps} =$	277.7 ksi
layer 5	$f_{ps} =$	277.7 ksi
layer 6	$f_{ps} =$	277.7 ksi
layer 7	$f_{ps} =$	277.7 ksi
layer 8	$f_{ps} =$	277.7 ksi
layer 9	$f_{ps} =$	277.7 ksi
layer 10	$f_{ps} =$	277.7 ksi
layer 11	$f_{ps} =$	277.7 ksi
layer 12	$f_{ps} =$	277.7 ksi
layer 13	$f_{ps} =$	277.7 ksi
layer 14	$f_{ps} =$	277.7 ksi

nominal flexure resistance

	$a =$	5.28 in	
$M_r = \Phi M_n, \Phi = 1.00$	$\Phi M_n =$	9055.9 ft-kips	OK
<b>NEGATIVE MOMENT SECTION</b>			
$M_u = 1.25DC+1.5DW+1.75(LL+IM)$	$M_u =$	-4837.2 ft-kips	
	$a =$	0.17 in	
	$\Phi M_n =$	3527.5 ft-kips	NOT OK

### Shear Design

<b>CRITICAL SECTION AT 0.59</b>			
$V_u = 1.25DC+1.5DW+1.75(LL+IM)$	$V_u =$	405.0 kips	
$M_u = 1.25DC+1.5DW+1.75(LL+IM)$	$M_u =$	-2684.4 ft-kips	
or			
$V_u = 1.25DC+1.5DW+1.75(LL+IM)$	$V_u =$	364.8 kips	
$M_u = 1.25DC+1.5DW+1.75(LL+IM)$	$M_u =$	-2877.0 ft-kips	
max shear	$V_u =$	405.0 kips	
max moment	$M_u =$	2877.0 ft-kips	
Shear depth	$d_v =$	73.19 in	
Applied factored normal force at the section	$N_u =$	0	
Angle of diagonal compressive stresses	$\theta =$	36.00 °	

### STRAIN IN FLEXURAL TENSION REINFORCEMENT

$$\epsilon_s = \frac{\frac{M_u}{d_r} + \eta N_u + 0.5 V_u \cot \theta - A_{ps} f_{ps}}{E_s A_s + E_p A_{ps}} \leq 0.002$$

		at midspan	at endspan
resultant compressive stress at centroid	$f_{pc} =$	0.943 ksi	0.946 ksi

effective stress in prestressing strand after all losses

layer 1	$f_{po} =$	176.9 ksi	177.5 ksi
layer 2	$f_{po} =$	176.9 ksi	177.5 ksi
layer 3	$f_{po} =$	176.9 ksi	177.5 ksi
layer 4	$f_{po} =$	176.9 ksi	177.5 ksi
layer 5	$f_{po} =$	176.9 ksi	
layer 6	$f_{po} =$	176.9 ksi	
layer 7	$f_{po} =$	176.9 ksi	
layer 8	$f_{po} =$	176.9 ksi	
layer 9	$f_{po} =$		177.5 ksi
layer 10	$f_{po} =$		177.5 ksi
layer 11	$f_{po} =$		177.5 ksi
layer 12	$f_{po} =$		177.5 ksi
layer 13	$f_{po} =$		177.5 ksi
layer 14	$f_{po} =$		177.5 ksi



strain in flexural tension

		at midspan	at endspan
layer 1	$\epsilon_x =$	0.002000	0.002000
layer 2	$\epsilon_x =$	0.002000	0.002000
layer 3	$\epsilon_x =$	0.002000	0.002000
layer 4	$\epsilon_x =$	0.002000	0.002000
layer 5	$\epsilon_x =$	0.002000	
layer 6	$\epsilon_x =$	0.002000	
layer 7	$\epsilon_x =$	0.002000	
layer 8	$\epsilon_x =$	0.002000	
layer 9	$\epsilon_x =$		0.002000
layer 10	$\epsilon_x =$		0.002000
layer 11	$\epsilon_x =$		0.002000
layer 12	$\epsilon_x =$		0.002000
layer 13	$\epsilon_x =$		0.002000
layer 14	$\epsilon_x =$		0.002000

### Deflection and Camber

Deflection due to Prestressing Force at Transfer  
 Deflection due to Beam Self-Weight at Transfer  
 Deflection due to Beam Self-Weight at Erection  
 Deflection due to Haunch and Deck

		at midspan	at endspan
$\Delta_p =$		3.27 in	3.29 in
$\Delta_g =$		-1.49 in	
$\Delta_g =$		-1.44 in	
$\Delta_s =$		-1.95 in	

Deflection due to total self weight

$\Delta_{sw} =$		-0.11 in	
-----------------	--	----------	--

Total Deflection at transfer

$\Delta =$		1.79 in	1.81 in
------------	--	---------	---------

Total Deflection at erection

$\Delta =$		3.24 in	3.27 in
------------	--	---------	---------

Live load deflection limit = span/800

$=$		1.80 in	
-----	--	---------	--

Deflection due to live load and impact

$\Delta_L =$		-0.90 in	
--------------	--	----------	--

OK

Deflection due to fire truck

$\Delta_L =$		-0.8127 in	
--------------	--	------------	--

OK

Total Deflection after fire with fire truck

$\Delta =$		2.3521 in	
------------	--	-----------	--